



**UYİK**

**PROCEEDINGS**

**BOOK**

21- 23 MAY 2024  
İSTANBUL- TÜRKİYE





# V. INTERNATIONAL APPLIED STATISTICS CONGRESS

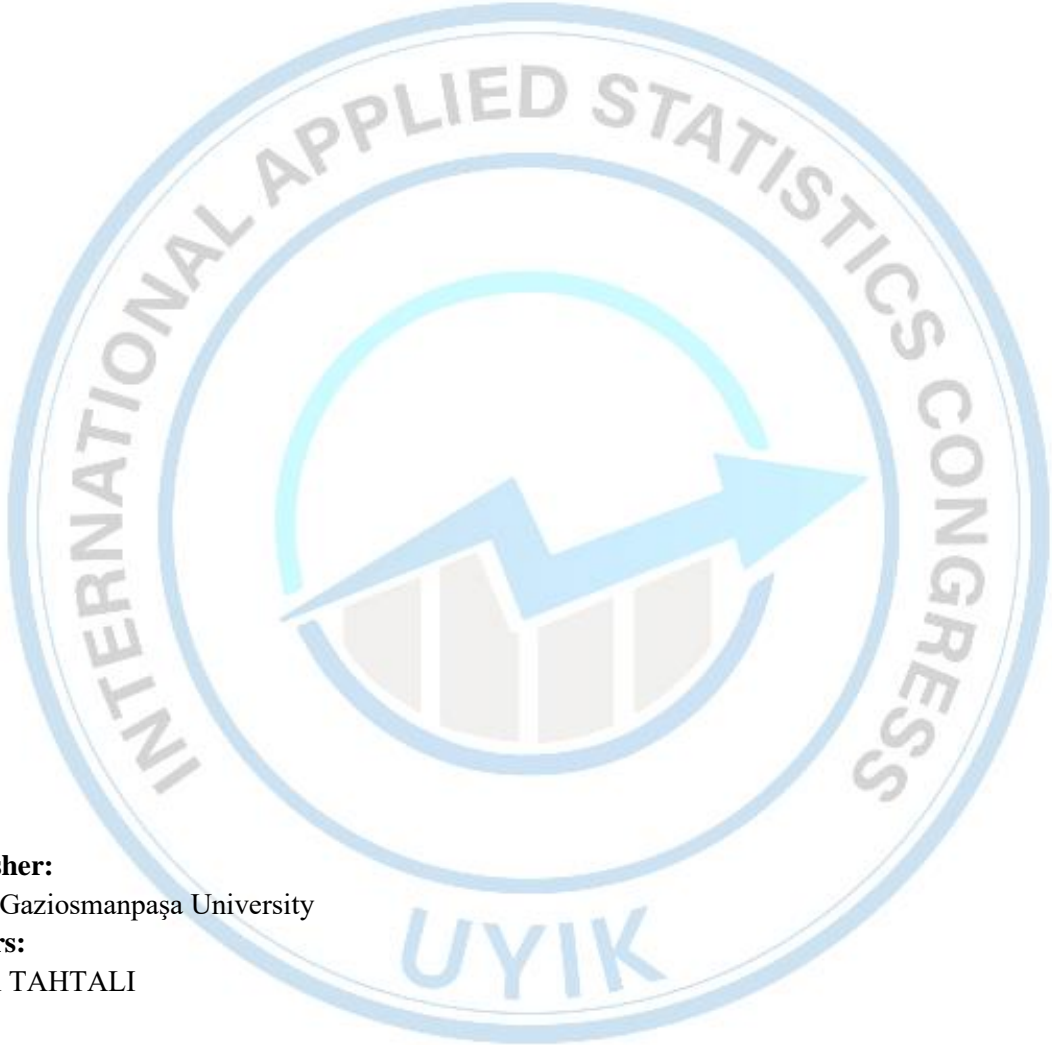
Proceedings Book of the UYİK-2024

ISBN: 978-975-7328-96-4

HYBRID (ONLINE AND FACE TO FACE) – İSTANBUL / TÜRKİYE

**Note:** All administrative, academic and legal responsibilities of the departments belong to their authors

**Proceedings Book of the V. International  
Applied Statistics Congress  
(UYIK-2024)**



**Publisher:**

Tokat Gaziosmanpaşa University

**Editors:**

Yalçın TAHTALI

**E-Book Layout, Preparation and Composition:**

Yalçın TAHTALI, Samet Hasan ABACI, Kaan KAPLAN, Lütfi BAYYURT, Shiva SADIGHFARD

All published articles were peer-reviewed by Scientific Committee

The organizers do not have any legal liability for to contents of the presentation texts

**Organized by**

Tokat Gaziosmanpaşa University, Tokat, Türkiye

Marmara University, Istanbul, Türkiye

Selçuk University, Konya, Türkiye

TUBİTAK, Ankara, Türkiye



**COMMITTEES**

**HONORARY PRESIDENT**

Prof. Dr. Erol ÖZVAR President of the Council of Higher Education, Türkiye

**HONORARY COMMITTEE**

Prof. Dr. Fatih YILMAZ Rector of Tokat Gaziosmanpaşa University, Türkiye

Prof. Dr. Mustafa KURT Rector of Marmara University, Türkiye

Prof. Dr. Metin AKSOY Rector of Selçuk University, Türkiye

**CONFERENCE CHAIRMANS**

Prof. Dr. Rüstem CANGİ Tokat Gaziosmanpaşa University, Türkiye

Prof. Dr. Deniz İNAN Marmara University, Türkiye

Prof. Dr. Semahat KÜÇÜKKOLBAŞI Selçuk University, Türkiye

Prof. Dr. Soner ÇANKAYA Ondokuz Mayıs University, Türkiye

Assoc. Prof. Dr. Yalçın TAHTALI Tokat Gaziosmanpaşa University, Türkiye

**CONGRESS SECRETARIAT**

Assoc. Prof. Dr. Samet Hasan ABACI Ondokuz Mayıs University, Türkiye

Assoc. Prof. Dr. Nur İlkey ABACI Ondokuz Mayıs University, Türkiye

Dr. Semanur SARIÇAM Marmara University, Türkiye

Dr. Lütfi BAYYURT Tokat Gaziosmanpaşa University, Türkiye

Dr. Shiva SADIGHFARD Tokat Gaziosmanpaşa University, Türkiye

Res. Assist. Kaan KAPLAN Tokat Gaziosmanpaşa University, Türkiye

Res. Assist. Betül TARHANACI Tokat Gaziosmanpaşa University, Türkiye

Res. Assist. Yağmur KAYA Tokat Gaziosmanpaşa University, Türkiye

Didem DOĞAR Tokat Gaziosmanpaşa University, Türkiye

Mehmet KIZILARSLAN Tokat Gaziosmanpaşa University, Türkiye

Bahar KAYA ÇELİK Tokat Gaziosmanpaşa University, Türkiye

Mesut Gökay OKUR Tokat Gaziosmanpaşa University, Türkiye

Abdüssamed DURMUŞ Tokat Gaziosmanpaşa University, Türkiye

Yılmaz ERKANAT Tokat Gaziosmanpaşa University, Türkiye

Buğra Bora DEMİR Marmara University, Türkiye

İpek BİNGÜL Marmara University, Türkiye

Umay YENTUR Marmara University, Türkiye

**ORGANIZING COMMITTEE**

Prof. Dr. Özge CAĞCAĞ YOLCU Marmara University, Türkiye

Prof. Dr. Reza FARSHBAF Ege University, Türkiye

Prof. Dr. Taner TUNÇ Ondokuz Mayıs University, Türkiye

Prof. Dr. Ufuk YOLCU Marmara University, Türkiye

Prof. Dr. Coşkun KUŞ Selçuk University, Türkiye

Prof. Dr. Vjekoslav TANASKOVİK Ss. Cyril and Methodius University, Macedonia

Prof. Dr. Jonas TAMAS Eötvös Lorand University, Hungary

Prof. Dr. Vladica S. STOJANOVIC University of Criminal Investigation and Police Studies, Serbia

Prof. Dr. Akbar ASGHARZADEH University of Mazandaran, Iran

Prof. Dr. Hassan Salah Hassan BAKOUCH Tanta University, Egypt

Prof. Dr. Hugo S. SALINAS Universidad de Atacama, Chile

Prof. Dr. Wenhao GUI Beijing Jiaotong University, China



**V. INTERNATIONAL APPLIED STATISTICS CONGRESS (UYİK - 2024)**  
**İstanbul / Türkiye, May 21-23, 2024**

---

**ORGANIZING COMMITTEE**

Prof. Dr. Christophe CHESNEAU	University of Caen, France
Prof. Dr. Bary ARNOLD	University of California, USA
Prof. Dr. Shaomin WU	University of Kent, England
Prof. Dr. Mohammad Z. Raqab	Kuwait University, Kuwait
Prof. Dr. Amer Al-Omrani	Al-al Bayt University, Jordan
Assoc. Prof. Dr. Ahmed Z. AFIFY	Benha University, Egypt
Assoc. Prof. Dr. Bahman Pasman ESLAM	Agricultural and Natural Resources Research and Education Center, Iran
Assoc. Prof. Dr. Hakan POLATÇI	Tokat Gaziosmanpaşa University, Türkiye
Assoc. Prof. Dr. Mile MARKOSKI	Ss. Cyril and Methodius University, Macedonia
Assoc. Prof. Dr. Nihat TAK	Marmara University, Türkiye
Assoc. Prof. Dr. Nurhan KESKİN	Yüzüncü Yıl University, Türkiye
Assoc. Prof. Dr. Murat ARISAL	Marmara University, Türkiye
Assoc. Prof. Dr. Nuriye SANCAR	Near East University, Nicosia
Assoc. Prof. Dr. Rıdvan KARABULUT	Kayseri University, Türkiye
Assoc. Prof. Dr. Ufuk BEYAZTAŞ	Marmara University, Türkiye
Assoc. Prof. Dr. Yunus AKDOĞAN	Selçuk University, Türkiye
Assoc. Prof. Dr. Ahmet PEKGÖR	Necmettin Erbakan University, Türkiye
Assoc. Prof. Dr. Neslihan İYİT	Selçuk University, Türkiye
Assoc. Prof. Dr. Mehrnaz MOHAMMADPOUR	University of Mazandaran, Iran
Assist. Prof. Dr. Gizel BAKICIERLER	Marmara University, Türkiye
Assist. Prof. Dr. Demet SEZER	Selçuk University, Türkiye
Assist. Prof. Dr. Harun YONAR	Selçuk University, Türkiye
Assist. Prof. Dr. Pradeep MISHRA	Jawaharlal Nehru Krishi Vishwa Vidyalaya, India
Assist. Prof. Dr. Kadir KARAKAYA	Selçuk University, Türkiye
Assist. Prof. Dr. Aynur YONAR	Selçuk University, Türkiye
Assist. Prof. Dr. Neriman AKDAM	Selçuk University, Türkiye
Assist. Prof. Dr. Muslu Kazım KÖREZ	Selçuk University, Türkiye
Dr. Breno FRAGOMENI	University of Connecticut, USA
Dr. Bruna Giacomini SARI	Federal University of Santa Maria, Brazil
Dr. Dhananjay GAIKWAD	Amity University, India
Dr. Diego JARQUIN	University of Florida, USA
Dr. Dilek SABANCI	Tokat Gaziosmanpaşa University, Türkiye
Dr. Francisco PENAGARICANO	University of Wisconsin-Madison, USA
Dr. Hao CHENG	University of California, Davis, USA
Dr. Maghsoud BESHARATI	University of Tebriz, Iran
Dr. Mahdi SAATCHI	Iowa State University, USA
Dr. Murat ARISAL	Marmara University, Türkiye
Dr. Ozan EVKAYA	University of Edinburgh, England
Dr. Badamasi ABBA	Central South University, China
Dr. Razik Ridzuan Mohd TAJUDDIN	University Kebangsaan Malaysia
Res. Assist. Sümeyra SERT	Selçuk University, Türkiye
Res. Assist. Tenzile ERBAYRAM	Selçuk University, Türkiye
Res. Assist. Fahrettin KALKAN	Selçuk University, Türkiye
Res. Assist. Furkan KESKİN	Marmara University, Türkiye

**V. INTERNATIONAL APPLIED STATISTICS CONGRESS (UYIK - 2024)**  
**İstanbul / Türkiye, May 21-23, 2024**

---

**SCIENTIFIC COMMITTEE**

Prof. Dr. Akbar ASGHARZADEH	Mazandaran University, Iran
Prof. Dr. Hon Keung Tony NG	Bentley University, UK
Prof. Dr. Adnan ÜNALAN	Niğde Ömer Halisdemir University, Türkiye
Prof. Dr. Barry ARNOLD	University of California, USA
Prof. Dr. Ali FARAJZADEH	Razi University, Iran
Prof. Dr. Ali İhsan GENÇ	Çukurova University, Türkiye
Prof. Dr. Ali Reza VAEZİ	Zanjan University, Iran
Prof. Dr. Aydın ERAR	Mimar Sinan Fine Arts University, Türkiye
Prof. Dr. Barış AŞIKGİL	Mimar Sinan Fine Arts University, Türkiye
Prof. Dr. Bejtulla DEMIRI	International Balkan University, Macedonia
Prof. Dr. Birsen Eysi ERDOĞAN	Marmara University, Türkiye
Prof. Dr. Birdal ŞENOĞLU	Ankara University, Türkiye
Prof. Dr. Buğra SARAÇOĞLU	Selçuk University, Türkiye
Prof. Dr. Daniel LIBERACKI	University of Life Sciences in Poznan, Poland
Prof. Dr. Eren BAŞ	Giresun University, Türkiye
Prof. Dr. Daniel ZABORSKI	West Pomeranian University of Technology, Poland
Prof. Dr. Erol EĞRİOĞLU	Giresun University, Türkiye
Prof. Dr. Filiz KARAMAN	Yıldız Teknik University, Türkiye
Prof. Dr. Francisco CARVALHO	Polytechnic Institute of Tomar, Portugal
Prof. Dr. Gülay BAŞARIR	Mimar Sinan Fine Arts University, Türkiye
Prof. Dr. Han Lin SHANG	Macquarie University, Australia
Prof. Dr. Hassan Salah Hassan BAKOUCH	Tanta University, Egypt
Prof. Dr. İsmail KINACI	Selçuk University, Türkiye
Prof. Dr. Kire SHARLAMANOV	International Balkan University, Türkiye
Prof. Dr. Kenan YILDIZ	Tokat Gaziosmanpaşa University, Türkiye
Prof. Dr. Mehmet Ziya FIRAT	Akdeniz University, Türkiye
Prof. Dr. Mehrdad YARNIA	Islamic Azad University, Iran
Prof. Dr. Müjgan TEZ	Marmara University, Türkiye
Prof. Dr. Nimet YAPICI PEHLİVAN	Selçuk University, Türkiye
Prof. Dr. Ömer Cevdet BİLGİN	Atatürk University, Türkiye
Prof. Dr. Özkan GÖRGÜLÜ	Kırşehir Ahi Evran University, Türkiye
Prof. Dr. Özlem TÜRKŞEN	Ankara University, Türkiye
Prof. Dr. Paulo Canas RODRIGUES	University of Bahia, Brazil
Prof. Dr. Rüştü YAYAR	Tokat Gaziosmanpaşa University, Türkiye
Prof. Dr. Sait Erdal DİNÇER	Marmara University, Türkiye
Prof. Dr. Selahattin YAVUZ	Erzincan Binali Yıldırım University, Türkiye
Prof. Dr. Saim BOZTEPE	Selçuk University, Türkiye
Prof. Dr. Tahir HANALIOĞLU	TOBB University of Economics and Technology, Türkiye
Prof. Dr. Violeta MADZOVA	International Balkan University, Macedonia
Prof. Dr. Zeynel CEBECİ	Çukurova University, Türkiye
Prof. Dr. Wenhao GUI	Beijing Jiaotong University, China
Prof. Dr. Amer AL-OMRANI	Al-al Bayt University, Jordan
Prof. Dr. Gholamhossein HAMEDANI	Marquette University, USA
Prof. Dr. Mohamad Z. RAGAP	Kuwait University, USA
Assoc. Prof. Dr. Abhijit MANDAL	University of Texas at El Paso, USA

**V. INTERNATIONAL APPLIED STATISTICS CONGRESS (UYIK - 2024)**  
**İstanbul / Türkiye, May 21-23, 2024**

---

**SCIENTIFIC COMMITTEE**

Assoc. Prof. Dr. Fatih KIZILASLAN	University of Oslo, Norway
Assoc. Prof. Dr. Soutir BANDYOPADHYAY	Colorado School of Mines, USA
Assoc. Prof. Dr. Ahmet Atif EVREN	Yıldız Teknik University, Türkiye
Assoc. Prof. Dr. Natasha KRALEVA	International Balkan University, Macedonia
Assoc. Prof. Dr. Neslihan İYİT	Selçuk University, Türkiye
Assoc. Prof. Dr. Şenol ÇELİK	Bingöl University, Türkiye
Assist. Prof. Dr. Zhiyang (Gee) ZHOU	University of Wisconsin-Milwaukee, USA
Assist. Prof. Dr. M. Ali KHALVATI	Federal Agro-Environmental Research and Development Viona Consulting Inc.
Assist. Prof. Dr. Fearghal KEARNEY	Queen's University Belfast, UK
Assist. Prof. Dr. Kaiying JI	The University of Sydney, Australia
Assist. Prof. Dr. Miguel FONSECA	NOVA University, Portugal
Assist. Prof. Dr. Panagiotis PAPASTAMOULIS	Athens University of Economics and Business, Greece
Assist. Prof. Dr. Hakan KARADAĞ	Tokat Gaziosmanpaşa University, Türkiye
Assist. Prof. Dr. Damla İLTER FAKHOURI	Mimar Sinan Fine Arts University, Türkiye
Assist. Prof. Dr. Pradeep MISHRA	Jawaharlal Nehru Krishi Vishwa Vidyalaya, India
Dr. Razik Ridzuan Mohd TAJUDDIN	University Kebangsaan Malaysia, Malaysia
Dr. Busenur KIZILASLAN	University of Oslo, Norway
Dr. Hak-Keung LAM	King's College London, UK
Dr. Badamasi ABBA	Central South University, China
Dr. Yener ÜNAL	Cumhuriyet University, Türkiye



**ACADEMICIAN REPRESENTATIVE ASSIGNED TO PUBLISH AND EDITING**

In the realization of the congress titled V. International Applied Statistics Congress (UYIK-2024) organized by Tokat Gaziosmanpaşa University in cooperation with Marmara University and Selçuk University between May 21-23, 2024 in Istanbul/Türkiye, Assoc. Prof. Dr Yalçın Tahtalı has been assigned as the academic branch in publications and regulars with the approval of Tokat Gaziosmanpaşa University Rectorate dated January 12, 2024 and numbered E-23845617-804.99-385524.



## BIOGRAPHY OF ALEV ALATLI



Alev Alatlı, born in 1944 in İzmir, attended high school in Tokyo, Japan. She obtained her bachelor's degree in Economics & Statistics from Middle East Technical University (ODTÜ), and pursued her master's degree in Economics & Econometrics at Vanderbilt University in the United States with a Fulbright scholarship. Subsequently, she began her studies in philosophy and pursued her doctoral studies at Dartmouth College in New Hampshire, focusing on Theology, Thought, and the History of Civilization.

Returning to Turkey in 1974, she worked as a lecturer at the Faculty of Economics at Istanbul University and as a senior economist at the State Planning Organization in Ankara. She also collaborated on psycholinguistic studies with the University of California, Berkeley. Alatlı, along with Cumhuriyet Gazetesi, co-founded a magazine called "Bizim English" and later served as vice president of the Turkish Writers Cooperative (YAZKO).

In 1985 and 1986, her translated works of Edward Said's "Covering Islam" and "The Question of Palestine" were published. Her efforts to raise awareness about the Palestinian cause earned her the "Medal of Freedom" from Yasser Arafat while he was in exile in Tunisia in 1986. In 2006, she received the Mikhail Aleksandrovich Sholokhov 100th Anniversary Literary Award in Russia. In 2014, she was awarded the Presidential Culture and Arts Grand Prize in literature. She was honored with honorary doctorates from Bülent Ecevit University in 2012 and Süleyman Demirel University in 2017.

From 2005 to 2017, she served as the chairman of the board of trustees at Kapadokya Vocational School. From 2017 until her passing, she served as the chairman of the board of trustees at Kapadokya University. Her first published original work is "Aydın Despotism." This was followed by "Yaseminler Tüter mi Hala?" in 1985, and "Torturer," which won the Writers' Union's "Best Novel of the Year" award in 1987. "Viva La Muerte" preceded "Or'da kimse var mı?" in the quartet. "Nuke Turkey!" and "OK Musti, Turkey is Alright!" were published in 1993, following "Viva la Muerte." "Kadere Karşı Koy A.Ş." was published in 1995. She released a small prose-poetry essay titled "September 1998" in 1999, followed by "Schrödinger's Cat, Nightmare" in 2000, and "Schrödinger's Cat, Dream" in 2001. The first part of the river novel titled "In the Footsteps of Gogol," "Not Enlightenment, But Mercy," was published in the fall of 2004, followed by "World Watch" and "Oh my sorrow! Oh my sorrow!".

"Hollywood'u Kapattığım Gün" was published in 2009, "Funda's Kitchen Guide" in 2011, and "White Turks Are Offended" in 2013. She played a significant role as a compiler in the four-volume "Texts Shaping the West" and the two-volume "Texts Shaping Us" published by Kapadokya Vocational School Publications. This work, which was carried out for the first time in Turkey, shed light on an intellectual adventure of nearly three years in both the West and the Islamic world. "It's Not Enough to Say This Is How I Think!" published in 2018, draws attention to the rules of reasoning and judgment.

Additionally, Alatlı has books consisting of her interviews titled "Turkey and the World with Alev Alatlı," and collections of newspaper articles including "If Not Now, When?" in 2002, "One Must Be Able to Say No!" in 2003, "Remember! The Past is the Future" in 2004, "Without Comments" in 2008, and "The Path of Reasoning Is Not the Only One" in 2009.

**PRESENTATION CONTENTS**

ABSTRACT ORAL PRESENTATIONS .....	1
Crypto Price Similarity: An Investigation Using Cross Correlation .....	2
Some Statistical Developments in Higher Education in Innovative Technology in The Sports Industry3	
Categorical Data Clustering to Detect Outliers .....	4
Dijital İrkçılığın Tespitinde Makine Öğrenmesi Metotlarının Karşılaştırmalı İncelemesi: Sosyal Medya Verileriyle Brexit.....	5
Avrupa Birliğinde Yenilenebilir Enerji ile Enerji İthalat Bağımlılığı Arasındaki İlişki: MMQR ve Nedensellik Analizinden Kanıtlar .....	6
Türkiye’de Yer Alan Lisanslı Güneş Panellerine İlişkin Nokta Verilerinin Mekansal İstatistiklerle Analizi .....	7
Makine Öğrenmesinde Özellik Seçimi Yöntemleri Kullanılarak Sınıflandırma Algoritmalarının Performans Karşılaştırması .....	8
Earthquake Magnitude Prediction in Morocco Region Using Machine Learning Techniques.....	9
An Ensemble Approach for Telecom Customer Churn Prediction Model.....	10
Evaluation of Portfolio Performance Ratio for Achieving Above-index Returns: A Case Study on Istanbul Stock Exchange (xu030).....	11
Analysis of Artificial Intelligence Methods in Classifying Heart Attack Risk: Black-box Models vs. Glass-box Models.....	12
Bulanık Kümeleme Yöntemleri Yapay Zekâ Uygulamalarında Neden Önemli? .....	13
Asymptotic Results for a Modification of Renewal-reward Process with Normal Distributed Interference of Chance and Delay .....	14
Bayesian Hierarchical Analyses for Entrepreneurial Intention Of Students .....	15
CQI-8 Level Process Audit (LPA) in a Factory in the Tire Industry .....	16
Çok Kriterli Karar Verme Yöntemi ile Elektrikli Otobüs Seçimi .....	17
Karesel Tablolarda MDR Tekniği ve Simetri Modellerinin Karşılaştırması .....	18
On Function-on-Function Partial Quantile Regression .....	19
Çanakkale’de Rüzgâr Enerji Santrali Kurulum Yerlerinin Mekânsal Analizi.....	20
Ham Petrol Fiyatlarının Makroekonomik Göstergeler Üzerindeki Etkileri: Favar Yaklaşımı.....	21
Aykırı Değer Tespitinde Kategorik Veri Kümeleme .....	22
Ranking of European Airports According to Sentiment Scores.....	23
Data Mining in Dietary Pattern Analysis .....	24
Examination of Hotel Reviews Using Text Mining and Natural Language Processing Methods .....	25
Yapay Öğrenme ile Kredi Ödenebilirliğinin Tahmini: Bir Veri Bilimi Yaklaşımı.....	26
Estimating Air Pollution in Istanbul Through Machine Learning Techniques .....	27
Makine Öğrenme Algoritmaları ile Müzikte Duygu Sınıflandırması .....	28
Makine Öğrenmesi Yöntemleri ve Performans Analizi .....	29
Üniversite Öğrencilerinin Saldırganlık Düzeylerini Etkileyen Faktörler.....	30
The Evaluation of the Environmental Performance of Eastern European Countries with the Integrated	



**V. INTERNATIONAL APPLIED STATISTICS CONGRESS (UYİK - 2024)**  
**İstanbul / Türkiye, May 21-23, 2024**

---

Entropy and Waspas Method .....	31
PCA Analysis of Data Series from Biodegradation of Alternative Organic Materials Mixtures for Renewable Energy Profit.....	32
Lineer Olmayan Kesirli Diferansiyel Denklemlerin Varyasyonel İterasyon Metodu ile Çözümü.....	33
Approximate Solutions of Nonlinear Fractional Differential Equations by Variational Iteration Method .....	34
Determining the Best Probability Distribution Models for the Long-term Temperature and Rainfall Data Observed at the Adana Meteorological Station in Türkiye.....	35
Developing Grade/tonnage Curves and Estimating Confidence Intervals for Long-term Temperature Data Observed in Adana Province, Türkiye.....	36
Application of Statistical Techniques for Determination of Relationships Between Water Quality Parameters of Kasap Stream in Lake Van Basin.....	37
Deney Tasarımı Yaklaşımı ile Tüketicilerin Duyusal Nitelik ve Eğilimlerinin Belirlenmesi.....	38
Elektrikli Araçlarda Kullanılan Fren Sistemi Parçalarının İstatiksel Proses Kontrol ve 6 Sigma Uygulamaları.....	39
Modeling Life Satisfaction Based on Subgroups in Panel Data.....	40
Evaluation of Financial Performance of Businesses in BIST Information Technologies Index with MOORA-Ratio Methods .....	41
Hisse Senedini İstatistiksel Yöntemlerle Tahmin Etme .....	42
Wheather Forecasting with Machine Learning .....	43
Makine Öğrenme Yöntemleri ile Telekomünikasyon Müşteri Kaybı Analizi .....	44
Locally Sparse and Robust Partial Least Squares in Scalar-on-Function Regression.....	45
Python ile Web Sitelerinden Veri Çekme .....	46
Fuzzy Esnek Küme Yöntemi Kullanılarak Tıbbi Karar Verme .....	47
Dermai: Her Zaman Erişilebilir Dermatolojik Çözümler.....	48
Robust Function-on-Function Regression: A Penalized Tau-Based Estimation Approach.....	49
Moment-based Approximations for Stationary Characteristics of a Stochastic Control Model of Type (s,s) with Asymmetric Triangular Distributed Interference of Chance .....	50
Lindley Nadarajah-haghighi Distribution.....	51
Estimation for the Multicomponent Stress-Strength Reliability under Continuous Bernoulli Distribution.....	52
Bibliometric Analysis of Published Studies on Poisson Processes .....	53
Climate Change Performance: Analysis of Factors Affecting CO <sub>2</sub> Emissions .....	54
The Emerging Trends of Statistical Analysis for Language and Literature Research: A Developing Country Perspective .....	55
Evaluation of Family and Romantic Relationships of Young Adults with Boarding School Experience within the Framework of Attachment Theory: A Phenomenological Study .....	56
The Mediating Role of Gender and Income in The Effect of Generation Z Financial Behaviors on Conscious Consumption.....	57
Evcil Hayvanlara Dönük Pazarlama Literatürünün Gelişiminin Bibliyometrik Analiz ile İncelenmesi	58
İklim Değişikliğinde Gençlerin Farkındalığı ve Yeşil Mutabakat Eylem Planı Üzerine Bir Nicel	

**V. INTERNATIONAL APPLIED STATISTICS CONGRESS (UYIK - 2024)**  
**İstanbul / Türkiye, May 21-23, 2024**

Araştırma.....	59
Material Technology in Activity Therapy for the Elderly in Youth and Sports Clubs .....	60
Topluluk Öğrenmesi Yöntemleri ile Sigorta Suistimallerinin Tespit Edilmesi .....	61
Girişimcilerin E-İhracat Eğilimleri: Engeller ve Çözüm Önerileri .....	62
Yatırım Araçlarının Enerji Değişimlerinin Faz Düzlemleri Aracılığıyla İncelenmesi.....	63
Karbondioksit Emisyonu ve Yenilenebilir Enerji Arzı Arasındaki İlişkinin Türkiye için İncelenmesi	64
Effect of Different Growing Mediums on Nutritional Values and Plant Development of Edible Flowers.....	65
Blockchain for Information Centres and Libraries: Systematic Review and Meta Analysis .....	66
The Role of Business Systems Levaraging on the Supply Chain Performans with the Effect of Information Sharing as The Mediator: The Case of Manufacturing Firms .....	67
Statistical Inference of Process Capability Index Cpm* for the Chen Distribution with Application ..	68
Otoregresif Kesirli Bütünleşik Hareketli Ortalama (ARFIMA) Modelinin Belirlenmesi: Türkiye, Hindistan ve Brezilya Ülkeleri Üzerine Uygulama.....	69
Anomaly Detection for Retail Stores' Rental Payments: A Forecasting Approach.....	70
A Novel Two-layer Feature Selection Method .....	71
Gene Selection Using Binary Tuna Swarm Optimization.....	72
Binary Chernobyl Disaster Optimizer for 0-1 Knapsack Problems .....	73
Evaluation of Machine Learning Algorithms Based on Particle Swarm Optimization and Elastic Net Feature Selection for Heart Disease Prediction.....	74
Üretim İşletmelerinde Çalışan Eğitimi için Kullanılacak Sanal Gerçeklik Gözlüğü Seçim Probleminin Geliştirilmiş Bulanık Swara ve Bulanık Copras Yöntemleri ile Değerlendirilmesi.....	75
Emerging Technologies for Educational Purposes: A Case Study of Urdu Literature Students.....	76
Kredi Kartı Kullanıcılarının Sadakat Puanlarının RFMD Tabanlı Hesaplanması ve Makine Öğrenimi Uygulamaları.....	77
Genetic Literacy from the Big Data Analytics Perspective.....	78
Veri Analitiği Destekli Pazar Analizi: Havacılık Sektöründe Resmî Tatil Dönemlerinde Gelir Artışı	79
Advanced Technology-Assisted Mental Health Monitoring and Intervention System: An İot-Based Approach .....	80
İklim Değişikliği Göstergelerinden Olan Aylık Maksimum Sıcaklık Değişiminin Fonksiyonel Veri Analizi ile İncelenmesi: Antalya İli Örneği.....	81
Modelling of Count Data in Circular Statistics .....	82
Modelling Climate Change Impact on Soil Loss in Tokat .....	83
Robust Regression Analysis of CO2 Emission Dataset for Turkey .....	84
Süt Sığırlarında Panel Veri Anlizi ile Laktasyon Eğrilerinin Modellenmesi .....	85
Long-Term Analysis of Sunspot Cycles with Markov Chain Modeling.....	86
Cereal Crop Planting Trends and Price Dynamics: Insights from Turkey .....	87
Measurement of Efficiency of Product Groups of A Retail Company Using Data Envelopment Analysis.....	88
Application of Ensemble Methods for Financial Time Series Forecasting .....	89

**V. INTERNATIONAL APPLIED STATISTICS CONGRESS (UYİK - 2024)**  
**İstanbul / Türkiye, May 21-23, 2024**

Different Estimation Methods in Multinomial Logistic Regression .....	90
Impact of Covid-19 on Annuity: Lee-carter and Temporary Mortality Jump Model .....	91
Biased Estimators in the Generalized Linear Models .....	93
A Robust Approach Using M-estimation for Dynamic Panel Autoregressive Model.....	95
Recent Applications of Agriculture 4.0 and Smart Farming Ecosystems .....	96
Weibull Dağılımına Uyum İyiliği Testlerinde Parametre Tahminlerinin Etkisi .....	97
Survival Data Modeling for Inventory Management .....	98
Combining Information Criterion with ROC Curve for Model Selection.....	99
Plsregs: An R Package for Partial Least Squares Algorithms .....	100
Sıralı Küme Örneklemede Ortalama Tahminine Yeni Bir Yaklaşım: Alt-tahmin Ediciler .....	101
Hava Yolu Şirketlerinin Finansal ve Operasyonel Durumlarının Çok Kriterli Karar Verme Yöntemleri ile Değerlendirilmesi .....	102
Virtual Water and Linkage with Water Accounting.....	103
Zaman Pencereyi Araç Rotalama Problemi: Saha Ekiplerinde Bir Uygulama .....	104
Measuring Innovation Performance of Brics-T Countries with Integrated Entropy and Waspas Method .....	105
Çok Kriterli Karar Verme Yöntemleri Kullanılarak Bazı Orta Doğu Ülkelerinin Yaşam Kalitesine Göre Değerlendirilmesi .....	106
Avrupa Ülkelerinin Temel Gıda Fiyatları Açısından Çok Boyutlu Ölçekleme Analizi ve Hiyerarşik Kümeleme Analizi Kullanılarak Karşılaştırması.....	107
Evaluation of Food Dryer Selection Criteria Using the Analytic Hierarchy Process.....	108
Determination of Shell Food Drying Machine Selection Criteria Weights Using the Best-Worst Method .....	109
Optimal Reinsurance Using Promethee Method .....	110
Sigortacılık Sektöründe Müşteri Ürün Eğilim Modellemesi .....	111
Comparing Forecasting Models: Sample Size Effects on Forecast Accuracy with Application Financial Data .....	112
The Effect of Interspecific Hybrid Eggplant Rootstocks on Early Yield.....	113
Simultaneous Selection for Early Maturity and High Yield in Advanced Sesame Lines .....	114
Determination of the Effects of Different GA3 and Micronutrient Combinations on Gerbera Plant Growth and Development .....	115
The Physiological Mechanism of Salinity Stress in Four Tall Fescue Cultivars .....	116
Determination of Plant Protection Problems of Tea Production in the Province of Rize .....	117
Kuşburnu (Rosa Canina) Bitkisinin Aşı ile Çoğaltılmasında İklimlendirme Süresinin Fidan Gelişimine Etkileri.....	118
Etlik Piliçlerde Farklı Modellerle Büyüme Eğrilerinin Tahmini ve Karşılaştırılması.....	119
Bahçe Bitkilerinde Antosiyenin Tahmini için Makine Öğrenimi Tabanlı Geliştirilen Yöntemler ve Karadut Örneği.....	120
Naşi Armudu Kurutma Sürecinin Görüntü İşleme Metodu ile Analizi.....	121
Financial Connectedness Among the Sectors Listed in BİST .....	122



**V. INTERNATIONAL APPLIED STATISTICS CONGRESS (UYİK - 2024)**  
**İstanbul / Türkiye, May 21-23, 2024**

---

Spatial Analysis of Poverty in Turkey .....	123
A Statistical Review of Regional Disparities in the Turkish Higher Educational System .....	124
The State of Strategic Planning Process within Turkish Higher Educational System. An Evaluation&nbsp; of the Paradox Through Statistical Quality Control Systems.....	125
Türkiye’deki Ekonomik Büyüme Üzerine Gecikmesi Dağıtılmış Otoresif Sınır Testi Yaklaşımı	126
Time Series Forecasting with Fuzzy Long-Short Term Memory Functions.....	127
Type-1 Fuzzy Svr Functions Approach Based on The Fuzzy C-medoids Clustering Algorithm for Time Series Forecasting .....	128
A Novel Hierarchical Time Series Forecasting Model Based on Fuzzy Svr Functions.....	129
Comparative Study of ARIMA Model and Deep Learning Models in Energy Demand Forecasting .	130
A New Time Series Prediction Model Based on Single-valued Neutrosophic Sets.....	131
Investigating the Effectiveness of Mathematics Education in Computer Engineering and Software Engineering Programs, and Its Contributions to Education and Business Life.....	133
Crime and Deterrence in Criminal Records and Statistics .....	134
Inappropriate Applications of Statistical Methods in Agricultural Research: Challenges of Violating Assumptions in Variance Analysis, Regression Analysis, and Mean Comparison Methods.....	135
Evaluation of Videos on Wisdom Tooth Extraction on YouTube: A Methodological Study .....	136
The Estimation of Seismic Hazards in Eastern Turkey and Its Surrounding Area by Statistical Approaches.....	137
Türkiye’de Yer Alan Lisanslı Güneş Panellerine İlişkin Nokta Verilerinin Mekansal İstatistiklerle Analizi .....	138
An Dynamic Efficiency Measurement of Health Service for Turkey .....	139
Modelling and Prediction of Sheep Numbers in China, India and Australia Using Artificial .....	140
Statistical Evaluation of Some Micro Elements (li, Mn, Ni And Ba) Accumulated in Sediments of Turkish Straits Watersheds.....	141
The Seismic Hazard Assessment of Yatağan, Turkey Using Statistical Methods .....	142
Spatio – Temporal Variations and Statistical Evaluation of Some Macro Elements (na, Mg, K, Ca) in Sediments of Felent Stream (Sakarya River Basin) .....	143
Microarray Analysis of Multivariate Escherichia Coli Bacteria Datasets with R Programming .....	144
Classification of Provinces According to Trial Statistics with Cluster Analysis .....	145
Veri Zarflama Analizi ile Etkinlik Ölçümüne İstatistiksel Yöntemlerle Yaklaşım: Bİst Sürdürülebilirlik Endeksi Örneği .....	146
İşletmelerde Müşteri Sadakatine Yönelik Bir Akıllı Erp Uygulaması: Mal Fazlası Hesaplaması.....	147
Mitigation of Geological Risk in the Estimation of Hydrocarbon Reserves and Resources of Productive Series in the South Caspian Basin.....	148
Application of Response Surface Methodology for the Optimization of Electrochemical Boron Separation from Aqueous Solution .....	149
Iot-based Smart Green-House System with Led Light Control .....	150
2D-QSAR Model Development for D3 Receptor Antagonists .....	151
Bayesci İstatistikler: 1990-2024 Dönemi için İngilizce Olarak Yayınlanan Makalelerin Bibliyometrik Analizi .....	152

**V. INTERNATIONAL APPLIED STATISTICS CONGRESS (UYİK - 2024)**  
**İstanbul / Türkiye, May 21-23, 2024**

---

Benchmarking: An Overview with an Example to Turkish Universities Under DEA Context .....	153
Investigation of Marriage-Divorce Pattern of Turkish Regions Using Mcdm and Machine Learning Approaches .....	154
An Application of Cluster Analysis in the Automotive Sector .....	155
Classification of Eye Diseases in Fundus Images Using Deep Learning Algorithms.....	156
Frequency of Use of Partial Least Squares Structural Equation Modelling (pls-sem) in Educational Administration Research .....	157
Kişi - Örgüt Uyumunun İş Tatmini Üzerindeki Etkisinin İncelenmesi: İnşaat Sektöründe İşgörenler Üzerinde Bir Araştırma .....	158
Examining the Relationship Between Climate Change, Energy Consumption, and the Financial System: The Case of E7 Countries.....	159
Sustainability Reporting and Determination of the Relationship between Short-Term Dept and Profitability of Food Enterprises in BIST Sustainability Index with Panel Data Analysis .....	160
Türkiye için Yüzyıllıklar ve Süper Yüzyıllıkların Tahmini .....	161
Bayesian Estimation of the Inverse Pareto Distributions Based on the Joint Progressively Censored Data .....	162
A Deep Dive into the Support Vector Machines and Their Applications in Natual Sciences .....	163
Machine Faults Detection with Nonlinear Features for Predictive Maintenance Applications .....	164
Predictive Analytics in E-commerce: A Case Study on Next-item Recommendation Using User Interaction Data .....	165
Design and Implementation of Advanced Recommendation Systems for an Online Video Streaming Platform.....	166
Enhancing Sales Forecasting in Retails with Machine Learning Methods .....	167
The Impact of Ai-enhanced Virtual Reality Systems on Shopping Experiences .....	168
Modeling Reasons for Customer Churn in the Pay-TV Sector with Supervised Machine Learning ..	169
Enhancing E-commerce Sales Forecasting: A Comparative Analysis of Machine Learning Algorithms in the Post-pandemic Era.....	171
Personalized Product Recommendations in E-commerce: An Intelligent System Using ALS, SVD, and NMF .....	172
Neural Network-Enhanced Analysis of Advection-Dominance Including Dispersivity in Physical Perspective .....	173
Boyut İndirgeme Tekniklerinin Eğitim Başarısının Matematiksel Modellemesindeki Etkileri .....	174
An Empirical Analysis of Stock Price Prediction Using Deep Learning Methods: Lstm, Gru, Gan, and Wgan-gp.....	175
Unveiling Airline Costumer Sentiments: A Data-Driven Journey with Web Scraping and Logistic Regression Analysis .....	176
Deep Learning for Pneumonia Diagnosis: A Comparative Study and Decision Support Interface Implementation.....	177
Forecasting Stock Volatility Via Hybrid Deep Learning and Garch Family Models a Case Study From Bist30 .....	178
Bulanık Regresyon ve Makine Öğrenme Algoritmalarının Risk Yönetimindeki Rolü: Sağlık, Tarım ve Proje Yönetimi Alanları için Bir İnceleme.....	179

**V. INTERNATIONAL APPLIED STATISTICS CONGRESS (UYİK - 2024)**  
**İstanbul / Türkiye, May 21-23, 2024**

---

Arıtma Sisteminin Otomasyonu ile Beraber Devreye Alınması.....	180
Perakende Sektöründe Faaliyet Gösteren Bir Firma için Ürün Yerleşim Düzeni Belirlenmesi.....	181
A Novel Lifetime Q-distribution: Modeling, Properties, and Parameter Estimation .....	182
Symbiotic Search Algorithm Integrated Approach for Parameter Estimation of Kemp Q-Binomial Distribution.....	183
On the Q-Analogues of a Special Continuous Distribution .....	184
Parameter Estimation for the Q-multinomial Distribution Utilizing Metaheuristic Optimization Algorithm .....	185
Modeling Different Types of Claims in Canadian Automobile Insurance.....	187
PID Controller Design and Control for Inverted Pendulum System Using PSO Algorithm.....	188
Simülasyonla Yüksek Boyutlu Verilerde Eksik Veri Problemini Ele Alan Literatürlerin İncelenmesi .....	189
Türkiye’de Hayvan Hacı Konu Olan İcra Dosyalarının Ortalama Görülme Süresi Tahmini.....	190
Prediction of Milk Yield in Water Buffaloes (Bubalus Bubalis) by Genomic Models.....	191
Comparison of Methods Affecting Classification Performance on Imbalanced Data Sets.....	192
Random Walk Hypothesis and Econometric Modelling of It Stocks in the Indian Stock Market .....	193
Insurance and Financial Development, a Panel Data Analysis .....	194
The Relationship Between Development of the Insurance Sector and Environmental Quality .....	195
Achieving Competitive Advantage! Do We Only Need Good Financials? .....	196
Development of Decision Support Mechanisms for Innovation Portfolio Management in Defense Industry: A case Study on Tai .....	197
The Impacts of Atmospheric Teleconnections on Potential Evapotranspiration in the Central Anatolia Region, Türkiye.....	198
Geographically Weighted Generalized Log Gamma Regression (GWGLGR) Model .....	199
Performance Analysis Regarding Climate Change: The Case of Next Eleven Countries.....	200
Random Regression Analysis for Body Weight in Hair Goats .....	201
Examination of Diabetes Risk Factors and Diabetes Diagnosis Prediction with Logistic Regression Model .....	202
Evaluation of Grant Support Practices Implemented by Agriculture and Rural Development Support Institution in Dairy Cattle Farms.....	203
Determining the Causality Relationship Between Climate Data and Wheat and Barley Yield in Turkey with the Toda-Yamamoto Test.....	204
Forecast of Buffalo Assets in the TR83 Region and Türkiye for the Next Five Years (2024-2028)..	205
The Status and Forecast of Tomato Production in Tokat, Türkiye .....	206
Consumers' Knowledge, Attitude and Consumption Behavior Regarding Starch-Based Sugar: The Case of Ondokuz Mayıs University Faculty of Agriculture Students .....	207
Comparative Analysis of OECD Countries with Respect to R&D and Innovation Indicators by Using Machine Learning Algorithms .....	208
Omics Analysis Reveals the Involvement of Carbon and flavonoid Biosynthesis in Low Phosphorus Tolerance in Cotton.....	209





**V. INTERNATIONAL APPLIED STATISTICS CONGRESS (UYİK - 2024)**  
**İstanbul / Türkiye, May 21-23, 2024**

Sistematik Meta Analizi ile Belirlenen Risk Faktörleri Sayesinde Web Tabanlı Arayüz Tarafından Yapay zeka tabanlı Tip II Diyabet Hastalarında Total Testosteron Seviyesi Tahmini .....	355
Nutritional Status and Affecting Factors in Patients Diagnosed with Stroke.....	366
An Investigation of Monthly Maximum Temperature Changes as an Indicator of Climate Change Using Functional Data Analysis: The Case of Antalya Province.....	373
Investigation of Energy Changes of Investment Instruments Through Phase Planes .....	380
Ekonomik Büyüme ve Karbondioksit Emisyonu Arasındaki İlişkide Çevresel Kuznets Eğrisi Hipotezinin E7 Ülkeleri için Karşılaştırmalı Analizi .....	387
Yaşamsal Beklenti ve Ekonomik Göstergelerin Kanonik Korelasyon Analizi ile İncelenmesi Üzerine Bir Çalışma.....	395
Examining the Development of Pet Marketing Literature through Bibliometric Analysis.....	406
6 Şubat Deprem Felaketi Ardından Uygulanan Uzaktan Eğitim Sistemine Bakışın İncelenmesi ve Değerlendirilmesi: Ankara Hacı Bayram Veli Üniversitesi İktisadi ve İdari Bilimler Fakültesi ve Ankara Üniversitesi Fen Fakültesi Karşılaştırması .....	412
Assessing Online and Face-to-Face Education in Higher Education: The Experience with Education Systems Inventory .....	425
Application of Generalized Linear Mixed Models in R: A Case Study with Bellbirds .....	432
Smart Food Recognition with YOLOv8 Models.....	438
Alüminyum Alaşımli Binek Araç Jantlarının Dinamik Viraj Yorulma Testi ve Güvenilirlik Tahmini .....	448
Sample Size in Confirmatory Factor Analysis: Monte Carlo Simulation Study .....	453
A Dynamic Model Proposal for the Solution of a Multi-Period Multi-Criteria Decision-Making Problem: An Application with LOPCOW-MCRAT Integrated Method.....	460
Detection of Breast Cancer Using Ensemble Learning Technique .....	470
Salamuralık Asma Yapraklarında Bazı Kalite Parametrelerinin Karşılaştırılması.....	477
Veri Zarflama Analizi Yöntemi ile Türkiye’de Faaliyet Gösteren Hayat Dışı Sigorta Şirketlerinin Performanslarının İncelenmesi.....	483
The Relationship Between Foreign Direct Investment And Unemployment Rate In Türkiye: Evidence From The Fourier Toda-Yamamoto Test .....	498
New Developments in Statistical Physics and Its Applications in Technology .....	506
Increasing Production Planning and Control Efficiency by Using Machine Learning Methods in Standard Time Calculation.....	520
Statistical Inference of Process Capability Index $C_{pm}$ * for the Chen Distribution with Application .....	530
Excretion in Patients with Stroke and Factors Affecting .....	538
Analysis of Urban Traffic Dynamics at a Roundabout: A Case Study in Tirana.....	545
The Impact of Broadband Penetration on Economic Growth in Albania: An Empirical Analysis with data from 12 Regions, for the Period 2016-2022. ....	554
Konut Satış Tahminlerinin Coğrafi Bilgi Sistemi Tabanlı Analizi: İstanbul İli Örneği.....	564
Prediction: Case of a Specific Region in Albania .....	570
Evaluating Forecasting Models via Simulation.....	578
Characterization of Consumers Who Demand More EU Eco-Labels in Accommodation Services... 585	

**V. INTERNATIONAL APPLIED STATISTICS CONGRESS (UYİK - 2024)**  
**İstanbul / Türkiye, May 21-23, 2024**

---

Ətraf Mühitin Mühafizəsi və Turizm .....	590
A Deep Dive into the Support Vector Machines and Their Applications in Natual Sciences .....	596
Derin Öğrenme Tekniği Kullanılarak LSTM Algoritmaları ile İklim Verilerinin Tahmin Edilmesi..	603
Automatic Modulation Classification by Using Information Theory Based Features .....	610
Customer Product Propensity Modeling in the Insurance Industry.....	616
Weighted Approximation of the Stancu Type Generalisation of the Chlodowsky-Szazs Mirakyan Hybrid Operator .....	627
Detection of Obesity Levels Using Artificial Intelligence Methods .....	634
The Correlation between Characteristic Parameters of the February 6th Elbistan Earthquake and Displacement Demand of Reinforced Concrete Systems.....	642
Classification of Provinces According to Judicial Statistics .....	648
Analysis of Dynamics between Bacteria-Multiple Antibiotic by Using Incommensurate Fractional-Order System.....	664
Modeling Beef Production in Türkiye Using Narx Networks.....	681
Analysis of Small Ruminant Farms in Van Province Using Fuzzy Clustering Analysis.....	688
An Evaluation of XAI Methods for Object Detection in Satellite Images using YOLOv5 .....	694
Enhanced Hybrid Recommendation System: Integrating NBP, LSTM, and XGBoost for Personalized Online Retail Recommendations.....	702
Enhancing Sales Forecasting in Retail Industry with Supervised Machine Learning Algorithms.....	707
Development of an Artificial Learning-Based Network Traffic Prediction Model .....	712
Exploring Newborn Screening Results Data: Advanced Statistical and Machine Learning Techniques for Risk Detection .....	717
About Problems and New Approaches in the Theory and Methodology of Forming a Management System for State Development Programs in Conditions of Economy Transformation into Innovation - Statistical Research.....	721
Classification of Cherry Producers' Problems in Production (Tokat Central District Example) .....	726
Makine Öğrenmesi Yöntemleri ile İstenmeyen SMS Tespiti .....	731
Variant Analysis in Human Genome Sequences Using Surrogate Modelling and Machine Learning	739
Applying the Generalized Normal Distribution for Modelling Asset Returns Data .....	749
Ahşap Malzeme Üretimi ve Kullanımında Sonlu Elemanlar Analizi Uygulamalarının Avantajları ..	758
Managing the Replication Crisis: Difficulties and Prospects in Psychology with an Emphasis on Statistics .....	763
Transmuted Epanechnikov Exponential Distribution .....	770
The Role of Fuzzy Regression and Machine Learning Algorithms in Risk Management: A Review for the Fields of Health, Agriculture and Project Management.....	786
Düşünceden Ürüne: Python ile Prototipleme .....	794
RNNs and Transformer Model in case of Incomplete Time Series .....	800
Explainable Detection of Data Drift Using Partial Dependence Disparity Index in Real Datasets ....	806
Implementation of A Risk Assessment Model Aimed at Preventing Operational Errors in a Glass Factory.....	814



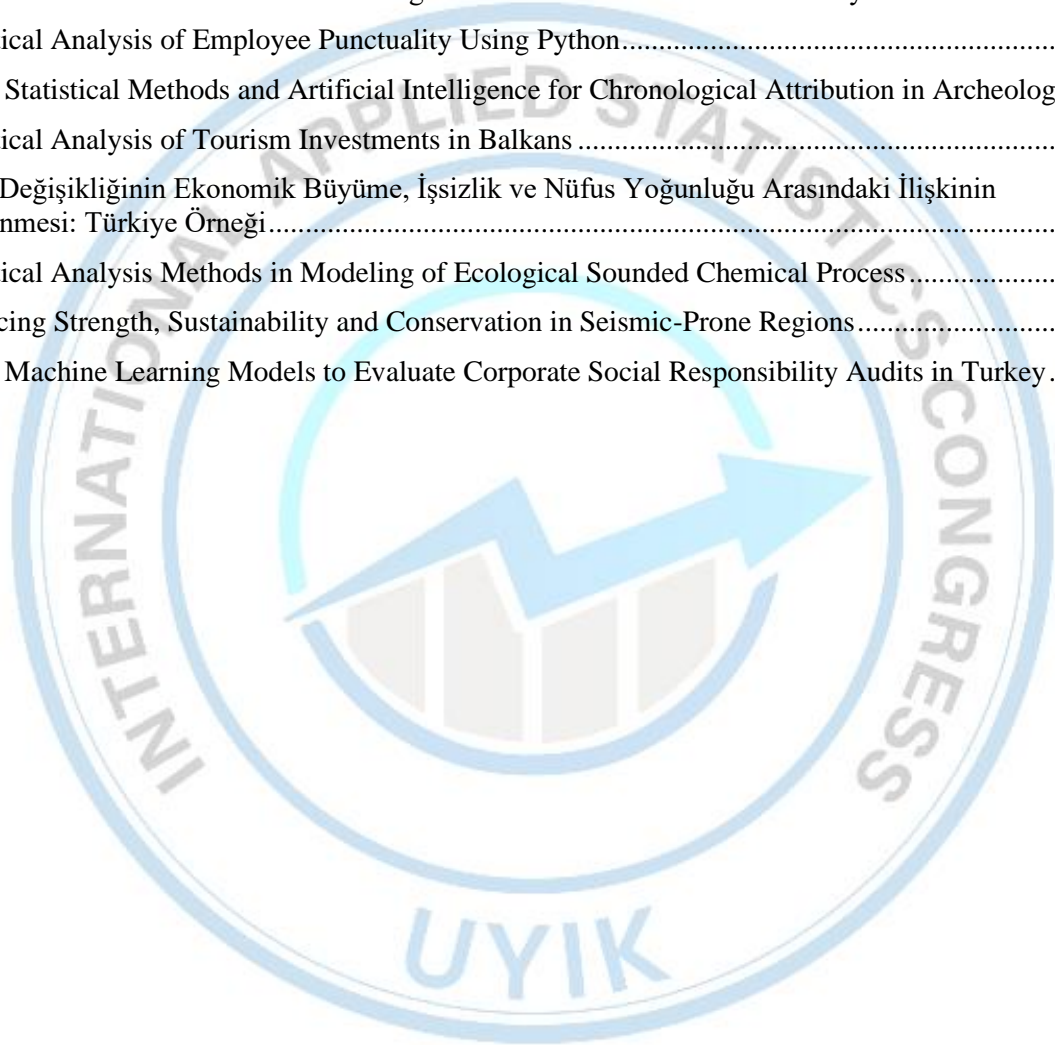
**V. INTERNATIONAL APPLIED STATISTICS CONGRESS (UYİK - 2024)**  
**İstanbul / Türkiye, May 21-23, 2024**

Implementing Artificial Intelligence in Agriculture: The case of Albanian Farmers .....	824
Rize İlinde Çay Üretiminde Karşılaşılan Bitki Koruma Sorunlarının Belirlenmesi .....	832
Basit Regresyon Modelinin Farklı Paket Programlar Uygulamaları .....	844
Investigation of Flowcharts and Decision Trees for Classification of Statistical Techniques .....	857
Marka Tercihini Etkileyen Faktörler: Ankara Hacı Bayram Veli Üniversitesi Ekonometri ve İktisat Bölümü Lisans Programı Öğrencileri Üzerine Bir Uygulama .....	864
İnsani Gelişme ve Ekonomik Büyüme: Gelişmekte Olan Ülkeler İçin Ampirik Bir Analiz.....	875
Kadınların İş Hayatlarından Memnuniyetlerinin Karşılaştırılması: İki Devlet Kurumu Örneği.....	884
Derivation of Linear and Non-linear Models for Estimating the Natural Gas Consumption.....	896
Regression Analysis as a Simple Approach for Developing Models to Forecast the Coal Consumption .....	904
Evaluating the Effectiveness of Occupational Safety and Ergonomics Inspections in Türkiye's Mining, Construction, and Metal Industries with an Integrated MCDM Model .....	912
Sağlık Sektöründe Operasyonel Yoğunluğun Sağlık Personelinin Kariyer Tercihlerine Etkisi: Bir Literatür Analizi .....	924
Yeşil Yalın Üretim Kapsamında Sürdürülebilirlik ile İlgili Bir Literatür Analizi .....	928
A Deep Dive into Stock Forecasting: Insights from LSTM, GRU, GAN, and WGAN-GP .....	938
<i>HSP90AA1</i> Gene Polymorphism in Hamdani Sheep .....	949
Farmers' Perception and Willingness to Pay For Early Warning Climate System in Albania. The Case of Wheat/Corn Crops in the Area of Korçe and Fier.....	954
Veri Madenciliği ve Çok Ölçütlü Karar Verme Yöntemleri ile Bir Hibrit Sınıflandırma Yaklaşımı .	971
Prediction of Compaction Parameters From Soil Index Properties By Using Multiple Regression Analysis.....	981
An Analysis on Changing the Age Farmers in Türkiye Over Time.....	989
Evaluation of the Education Levels of Agricultural Operators in Türkiye and The Evolution of Education Level Over Time .....	1002
Machine Faults Detection with Nonlinear Features for Predictive Maintenance Applications .....	1018
Adalet Kavramı ve Adalette İstatistiğe Duyulan İhtiyaç.....	1025
Farklı Enerji İçerikli Karma Yemlere Emülsifiyer İlavesinin Etlik Piliçlerin Canlı Ağırlıkları Üzerine Etkisinin Profil Analizi ile İncelenmesi .....	1040
ABSTRACT POSTER PRESENTATIONS .....	1046
A Modified Chi-Square Type Test for Distributional Validity with Applications to Right Censored Reliability and Medical Data.....	1047
A New Model of Nadarajah Haghighi: Properties, Characterizations, Modeling Environmental Data .....	1048
A Study on the Choice of Index and Form the Market Model for Indian It Sector Stocks.....	1049
Türkiye'de Boşanma Davası Sayılarının Zaman Serisi Analizi.....	1050
Reference Equations and Forced Oscillation Technique - A Great Need for the Diagnosis of Pulmonary Diseases in Small Children .....	1051
The Application of One-Way Anova in the Study of the Antioxidant Activity of Commercial Citrus Essential Oils.....	1052

**V. INTERNATIONAL APPLIED STATISTICS CONGRESS (UYIK - 2024)**  
**İstanbul / Türkiye, May 21-23, 2024**

---

Application of Custom Design in the Determination of the Optimal Maceration Conditions and the Effect of Photosensitive Nets on the Total Extractive Matter from French Marigold ( <i>Tagetes Patula L.</i> ) Petals .....	1053
Predictive Modeling of Earnings in Thoroughbred Racehorses in Türkiye: A Multi-Class Classification Approach Using C5.0 Algorithm .....	1054
Circular Statistics in Ophthalmology: A Review of the Literature .....	1055
Cash Subsidy or Childcare Service: An Analysis of the Fertility Effect of European Family Policy: Based on a Multi-level Regression Model .....	1056
FULL TEXT POSTER PRESENTATIONS .....	1057
Tarım Makinelerinin Güvenilirlik Göstergelerinin İstatistiksel Analiz Yöntemiyle Belirlenmesi ...	1058
Statistical Analysis of Employee Punctuality Using Python.....	1064
Using Statistical Methods and Artificial Intelligence for Chronological Attribution in Archeology	1072
Statistical Analysis of Tourism Investments in Balkans .....	1077
İklim Değişikliğinin Ekonomik Büyüme, İşsizlik ve Nüfus Yoğunluğu Arasındaki İlişkinin İncelenmesi: Türkiye Örneği.....	1085
Statistical Analysis Methods in Modeling of Ecological Sounded Chemical Process.....	1091
Balancing Strength, Sustainability and Conservation in Seismic-Prone Regions.....	1093
Using Machine Learning Models to Evaluate Corporate Social Responsibility Audits in Turkey ...	1097





# ABSTRACT ORAL PRESENTATIONS



## Crypto Price Similarity: An Investigation Using Cross Correlation

**Onur Batın Doğan<sup>1\*</sup>, Fatma Sevinç Kurnaz<sup>1</sup>**

<sup>1</sup>Yıldız Technical University, Graduate School of Science And Engineering, Statistics, 34349, Istanbul,  
Türkiye

\*Corresponding author e-mail: onurbatindogan@gmail.com

### ***Abstract***

*The cryptocurrency market has witnessed phenomenal growth, attracting both institutional and retail investors. However, the inherent volatility and complex price dynamics pose challenges in portfolio diversification and risk management. This study investigates price similarity among cryptocurrencies, employing the cross-correlation function to calculate Pearson correlation coefficients. We analyze price changes to capture linear relationships between cryptocurrencies. This study utilized the Binance API to acquire OHLCV (Open, High, Low, Close, Volume) data for 300 cryptocurrencies for 4 years. The cross-correlation function allows us to consider potential time lags in these relationships. High positive correlations indicate synchronized price movements, while negative correlations suggest opposing trends. By clustering cryptocurrencies based on these correlation coefficients, we aim to identify groups with similar price behavior, facilitating informed investment strategies. This analysis provides valuable insights into the interconnectedness within the cryptocurrency market, enabling investors to construct more informed investment strategies.*

**Keywords:** *Cryptocurrency Price Similarity, Pearson Correlation, Cross-correlation*

**Some Statistical Developments in Higher Education in Innovative Technology in The Sports Industry**

**Mürsel Akdenk**<sup>1,2\*</sup>

<sup>1</sup>Istanbul Esenyurt University; School of Physical Education and Sports: Istanbul-Türkiye.

<sup>2</sup>International University of Dublin; Sports Science Faculty; Medical Exercises Department; Integrated Professional Doctor Education Student: Dublin-Northern Ireland.

\*Corresponding author e-mail: murselakdenk06@gmail.com

***Abstract***

*Considering the Purpose of Innovative Technology in the Sports Industry; Evaluation of Some Statistical Developments in Higher Education; Studies in Australia in UNESCO Asian and Pacific Countries were examined. These; Sports Practices regarding the European Union, Germany and Türkiye were compared. The researcher; First, on December 31, 1993; Istanbul Technical University; Coordinator in the Department of Physical Education and Sports; Despite the "Conference on Engineering Studies in Sports"; There has still been no relevant development. Second Study; At the International Congress at Istanbul Yıldız Technical University; Presented on 10-12 June 2012; It offers; Following the declaration of "Comparative Sports Engineering Programs and the Australian Example", the door was not opened to innovative developments. Third study; Istanbul Esenyurt University; At the School of Physical Education and Sports; Given on December 3, 2021; At the Conference on the Announcement of the Able-bodied and Disabled Inclusion Project in Higher Education, issues such as Sports Engineering were brought to the agenda. In Global Findings; In Australia and Germany; Sports Engineering; In the fields of Sports Technologies; Associate Degree; Licence; It is seen that they include postgraduate studies called Master's and Doctoral Programs.*

**Keywords:** *Sports Engineering, Sports Technologies Engineering, Sports Architecture, Youth Work, Youth and Sport Architecture and Engineering Education Research and Application Center.*

## Categorical Data Clustering to Detect Outliers

**Oğuz Kaan Kılıç<sup>1\*</sup>**

<sup>1</sup>Gazi University, Graduate School of Natural and Applied Sciences, Department of Statistics, 06500, Ankara, Türkiye

<sup>1\*</sup>Corresponding author e-mail: oguzkaankilic@yahoo.com

### *Abstract*

*In order to ensure the correctness and dependability of the data set, identifying outliers in categorical data sets is a crucial stage in the modeling and data analysis processes. Data points that substantially deviate from the overall data structure are known as outliers, and they can skew the outcomes of analyses. As a result, it's critical to appropriately recognize and deal with these anomalies. By assembling data points according to their commonalities, clustering techniques are utilized in outlier detection. The data set's natural categories are found by these algorithms, which then classify non-conforming groups or those with very few data points as outliers. In particular, outlier detection in categorical data is frequently accomplished using algorithms like k-modes, ROCK, STIRR, and DBSCAN. These methods efficiently detect outliers in categorical data sets by employing various strategies and computational techniques. Selecting the best approach based on the needs of the data sets is essential, since every algorithm has advantages and limitations of its own. This study has looked closely at the significance of this process in data analysis as well as how these algorithms may be utilized to find outliers in sets of categorical data. The frequency of values for the dependent and independent variables has also been used to compare the effectiveness of these algorithms in detecting outliers. This approach will help identify the best outlier identification technique.*

**Keywords:** Data Mining, Categorical Data, Outlier Detection, Clustering Algorithms



## Dijital Irkçılığın Tespitinde Makine Öğrenmesi Metotlarının Karşılaştırmalı İncelemesi: Sosyal Medya Verileriyle Brexit

Sibel Dinc<sup>1\*</sup>, Fatma Noyan Tekeli<sup>2</sup>

<sup>1</sup>Milli Savunma Üniversitesi, Atatürk Stratejik Araştırmalar ve Lisansüstü Eğitim Enstitüsü, Stratejik İletişim Anabilim Dalı, 34330, İstanbul, Türkiye

<sup>2</sup>Yıldız Teknik Üniversitesi, Fen Edebiyat Fakültesi, İstatistik Anabilim Dalı, 34220, İstanbul, Türkiye

\*Sorumlu yazar e-mail: sibel.dinc@std.yildiz.edu.tr

### Özet

Dijital çağın yükselişiyle birlikte, ırkçılık ve yabancı düşmanlığı da yeni bir boyut kazanmıştır. Dijital ırkçılık, internet ve diğer dijital platformlarda yayılan, bireyleri etnik kökenleri, ırkları veya diğer kimlik özellikleri temelinde hedef alan bir tür ayrımcılık olarak tanımlanmaktadır. Özellikle sosyal medya platformları, kolay erişilebilirlikleri sebebiyle nefret söylemi ve ayrımcılığın hızlı bir şekilde geniş kitlelere yayılmasına olanak tanımaktadır. Günümüzde ülkeler dijital ırkçılığın artan bir toplumsal sorun haline geldiğini ve bir güvenlik sorunu olarak ele alınması gerektiğini tespit etmektedir. Türkiye'nin çeşitli etnik köken ve ırka sahip bireylere ev sahipliği yapması, dijital ırkçılığın ülke genelindeki etkilerini incelemek adına önemli bir vaka olarak incelenebileceğini göstermektedir.

İlgili çalışmada, büyük veri setlerini analiz ederek örüntüleri ve ilişkileri keşfetmeye olanak tanıyan yöntemlerden olan makine öğrenmesi metotları ile dijital ırkçılık kavramı incelenmiştir. Çalışmada dijital ırkçılığın tespitinde kullanılan makine öğrenmesi metotlarının etkinliği karşılaştırılmaktadır. Türkiye'de, sosyal medya platformlarından eski adıyla Twitter yeni adıyla "X" platformundan 2020-2022 yılları arasında paylaşılan ve ırkçı ve yabancı düşmanlığı içeren tweetler, çalışma için veri seti olarak kullanılmıştır. Toplanan veriler üzerinde Denetimli Makine Öğrenme Algoritmalarından olan "Karar Ağaçları, Lojistik Regresyon, Naive Bayes, Rastgele Orman ve Destek Vektör Makinası" algoritmaları ırkçılık ve yabancı düşmanlığı içeren içeriklerin sınıflandırılmasında kullanılmıştır.

Çalışma kapsamında her bir algoritmanın doğruluk, hassasiyet, özgüllük ve F1 skoru gibi performans metrikleri incelenmiştir. Elde edilen sonuçlar, Rastgele Orman algoritmasının ırkçı ve yabancı düşmanlığı içeren ifadelerin tespitinde diğer yöntemlere göre daha yüksek performans sergilediğini göstermektedir. İlgili çalışma, ırkçılıkla mücadelede etkili stratejiler geliştirmek, toplumda farkındalık yaratmak ve ırkçılıkla mücadelede kaynakların daha etkili kullanılması adına makine öğrenmesi algoritmalarının kayda değer katkılar sunabileceğini göstermesi bakımından önem taşımaktadır.

**Anahtar Kelimeler:** Makine Öğrenmesi Algoritmaları, Dijital Irkçılık, Sosyal Medya, X Platformu, Türkiye

**Avrupa Birliğinde Yenilenebilir Enerji ile Enerji İthalat Bağımlılığı Arasındaki İlişki:  
MMQR ve Nedensellik Analizinden Kanıtlar**

**İbrahim Ürkmez<sup>1\*</sup>**

<sup>1</sup>Ege Üniversitesi, İktisadi ve İdari Bilimler Fakültesi, İktisat bölümü, 35000, İzmir, Türkiye

\*Sorumlu yazar e-mail: ibrahimurkmez@gmail.com

**Özet**

*Bu çalışma yenilenebilir enerji tüketimi ile enerji ithalat bağımlılığı arasındaki ilişkiyi Avrupa Birliğinin 1995-2020 yılları arası yıllık panel verisini kullanarak incelemektedir. Değişkenler arasında eş bütünleşme ilişkisi bulunmuş olup yenilenebilir enerji tüketiminin enerji ithalat bağımlılığını azalttığı belirlenmiştir. Diğer yandan Değişkenler arasındaki ilişkiyi daha iyi anlamak için literatürden farklı olarak MMQR (Methods of Moments of Quantile Regression) kullanılmıştır. Bu yöntem normal dağılım varsayımını gerektirmez ve aykırı değerlere karşı dirençlidir. MMQR sonuçları yenilenebilir enerji tüketiminin enerji ithalat bağımlılığını azalttığı ve enerji ithalat bağımlılığının farklı kantil seviyelerinde bu etkinin farklılaştığını ortaya koymaktadır. Özellikle yüksek kantil seviyelerinde yenilenebilir enerjinin etkisi belirgin şekilde artmaktadır. Ayrıca analizde kontrol değişkenleri olarak kullanılan ekonomik büyüme ve efektif döviz kuru da istatistiki olarak anlamlı bulunmuştur. Ekonomik büyümenin artırıcı, efektif döviz kurunun ise azaltıcı etkiye sahip olduğu belirlenmiştir. Juodis vd., (2021) tarafından geliştirilen nedensellik analizi sonuçları ise, yenilenebilir enerji tüketiminden enerji ithalat bağımlılığına doğru tek yönlü bir nedenselliğin varlığını doğrulamaktadır. Dolayısıyla nedensellik ve MMQR sonuçları birbirini destekleyici niteliktedir. Bu sonuçlar, yenilenebilir enerji kullanımının çevresel tahribatı engelleme ve ötesinde ülkelerin ulusal enerji arz güvenliği, enerji ithalat bağımlılığının azaltılması, sürdürülebilir ekonomik kalkınma ve enerji kaynaklarının çeşitlendirilmesinde de önemli bir rol oynadığını göstermektedir. Bu sonuçlardan hareketle yenilenebilir enerji kaynaklarının kullanımının yaygınlaştırılması, yenilenebilir enerji teknolojilerinin geliştirilmesine yönelik kamusal teşvik ve uluslararası düzeyde enerjide iş birliğinin güçlendirilmesi Avrupa Birliğinin enerji bağımsızlığı ve arz güvenliğine giden yolda önemli adımlar olarak ön plana çıkmaktadır.*

**Anahtar Kelimeler:** Yenilenebilir enerji tüketimi, Enerji ithalat bağımlılığı, MMQR, Nedensellik Analizi, Avrupa Birliği

## Türkiye’de Yer Alan Lisanslı Güneş Panellerine İlişkin Nokta Verilerinin Mekansal İstatistiklerle Analizi

**Günseli Aytac Cankurtaran<sup>1\*</sup>, Özlem Türkşen<sup>2</sup>**

<sup>1</sup> Ankara Üniversitesi, Fen Bilimleri Enstitüsü, İstatistik ABD, 06100, Ankara, Türkiye

<sup>2</sup> Ankara Üniversitesi, Fen Fakültesi, İstatistik Bölümü, 06100, Ankara, Türkiye

\*Sorumlu yazar e-mail: ozlemturksen@gmail.com

### Özet

Günümüzde enerji ihtiyacı, nüfus artışı, hızlı teknolojik gelişmeler, ekonomik büyüme ve küreselleşme gibi etkenlere bağlı olarak artmaktadır. Güneş enerjisi, enerji tüketimine cevap verebilmek amacıyla kullanılan alternatif enerji kaynaklarından biridir. Kullanımı hızla artan güneş panelleri, enerji verimliliği konusunda oldukça önemli bir yere sahiptir. Bu çalışmada, Türkiye’de yer alan güneş panellerine ilişkin nokta verilerin mekansal istatistiklerle analizi yapılmıştır. Enerji Piyasası Düzenleme Kurumu tarafından lisans verilen işletmelerin güneş panellerine ilişkin nokta verileri ve öznitelik değerleri dikkate alınmıştır. Mekansal istatistikler, güneş paneli nokta verilerine üç temel başlıkta uygulanmıştır: (i) Mekansal Betimsel İstatistikler (Mekansal Ortalama, Standart Uzaklık, Standart Sapma Elipsi), (ii) Mekansal Örüntü Analizi (Kuadrat Analizi, En Yakın Komşuluk Yaklaşımı) ve (iii) Mekansal Otokorelasyon (Moran’ın I İndeksi, Variogram, Kriging). Mekansal istatistik analizlerinde RStudio programı kullanılmıştır. Keşfedici mekansal veri analizi ile nokta verilere ilişkin mekansal analizler yapılarak, mekansal otokorelasyon analizi ile Türkiye’de yer alan güneş panellerinin kurulu gücünün mekansal dağılımının rastgele olduğu görülmüştür. Kriging uygulanarak veri setinde yer almayan nokta verilere ilişkin kurulu güç değerleri minimum hata ile tahmin edilmeye çalışılmıştır.

**Anahtar Kelimeler:** Mekansal nokta analizi, Mekansal betimsel istatistikler, Mekansal örüntü analizi, Mekansal otokorelasyon, Güneş paneli.



**Makine Öğrenmesinde Özellik Seçimi Yöntemleri Kullanılarak Sınıflandırma Algoritmalarının Performans Karşılaştırması**

**Aylin Ucan<sup>1\*</sup>, Doğan Yıldız<sup>1</sup>, Nihat Tak<sup>2</sup>**

<sup>1</sup>Yıldız Teknik Üniversitesi

<sup>2</sup>Marmara Üniversitesi

\*Sorumlu yazar e-mail: aynucn@gmail.com

**Özet**

Özellik seçimi, makine öğrenmesi ve veri ön işleme süreçlerinde kritik bir rol oynar. Doğru özelliklerin seçilmesi, gereksiz bilgilerin filtrelenmesini, modelin daha iyi genelleştirilmesini sağlar ve özellikle yüksek boyutlu verilerde de modelin karmaşıklığını azaltmaya yardımcı olur. Böylece sınıflandırma ve tahminleme problemlerinin analizinde daha doğru ve güvenilir sonuçlar elde edilebilir. Bu çalışmada uygulama aşamasında kronik böbrek hastalığı veri seti kullanılmıştır. Özyinelemeli, Rastgele orman ve Boruta özellik seçimi yöntemleri kullanılarak belirlenen önemli özellikler ile üç farklı yeni veri seti elde edilmiştir. Daha sonra bu veri setleri makine öğrenmesi alanında yaygın olarak kullanılan sınıflandırma tekniklerinden Destek Vektör Makineleri, k-En Yakın Komşular ve Sade Bayes sınıflandırıcıları ile analiz edilmiştir. Analiz sonuçlarında elde edilen yüzdesel doğruluk değerleri karşılaştırılmıştır. Uygulama aşamasında elde edilen yüzdesel doğruluk değerlerine göre; özyinelemeli özellik seçimi ile oluşturulan veri setinin, destek vektör makineleri sınıflandırma yöntemi kullanılarak yapılan analizi sonucunda en yüksek doğruluk değerini verdiği gözlemlenmiştir. **Anahtar Kelimeler:** Özellik seçimi, Rastgele orman, Özyinelemeli özellik seçimi, Boruta, Sınıflandırma

## Earthquake Magnitude Prediction in Morocco Region Using Machine Learning Techniques

Elif Özceylan<sup>1\*</sup>, Aslıhan Sağıroğlu<sup>1</sup>

<sup>1</sup> Istanbul Arel University, Engineering Faculty, Computer Engineering Department, 34537, Istanbul, Türkiye

<sup>2</sup> Istanbul Arel University, Engineering Faculty, Industrial Engineering Department, 34537, Istanbul, Türkiye

\*Corresponding author e-mail: elifozceylan@arel.edu.tr

### Abstract

*Natural disasters are small or large scale natural events where human control is weak. Earthquakes are one of the natural disasters with the highest loss of life and damage. With today's technologies, early warning systems are being developed so that earthquakes can be known in advance and measures can be taken. Earthquake prediction studies are very important for the development of these systems. In this study, 6 different machine learning algorithms were trained for earthquake magnitude classification and the best performing model was selected. For this purpose, a data set was created by organizing the earthquake data between 2.0 and 10.0 magnitudes between 1981-2023 in Morocco at 24 hours intervals. Forward looking earthquake magnitude classification was performed on this data set. The study was performed on a data set with 12 input features and 1 output feature. For the classification process, mild earthquakes that occurred in the specified date range were evaluated and these earthquakes were labeled according to 3 different classes (less than 3.0, 3.0-3.9 and greater than 3.9). The algorithms used for earthquake magnitude classification in the study are random forest, k-neighbors, adaboost, logistic regression, naive bayes and decision tree. The success of the models were measured using 4 performance metrics (accuracy, recall, precision and f1 score). The model with the best results was determined as random forest.*

**Keywords:** Machine learning, Earthquake magnitude classification, Morocco earthquake, Time series prediction.

## An Ensemble Approach for Telecom Customer Churn Prediction Model

Seymanur Usta<sup>1\*</sup>, Fatma Noyan Tekeli<sup>1</sup>

<sup>1</sup> Yildiz Technical University, Faculty of Arts and Sciences, Department of Statistics, 34220, Turkey

\*Corresponding author e-mail: seymanurustaa@gmail.com

### *Abstract*

*In recent years, mobile communication has become the most important communication tool. In an environment of rapid technological developments and increasing competition, retaining customers is a competitive advantage for telecom companies. Since the cost of customer retention is much lower than attracting new customers, the problem of customer churn has become a major problem in various fields and especially in the Telecom Industry. In this research, a customer churn prediction model is proposed using nested ensemble techniques that combine the advantages of stacking and voting methods. This paper applied a nested ensemble model to the Telco Customer Churn dataset. This method combines various ensemble learning algorithms and basic learning algorithms in a composite model, allowing for leveraging the advantages of each. In the first layer, a stacking model was employed, followed by the utilization of both stacking and voting models in the second layer. Additionally, traditional algorithms including Naïve Bayes, Support Vector Machine, Random Forest, and Logistic Regression were employed as the base-level algorithms for the ensemble models within the framework. The implementation and comparison of the proposed system demonstrate that its performance increases accuracy by 0.04 compared to the current best method.*

**Keywords:** Customer churn, nested ensemble, ensemble learning



**Evaluation of Portfolio Performance Ratio for Achieving Above-index Returns: A Case Study on Istanbul Stock Exchange (xu030)**

**Mertcan Kurtcu<sup>1\*</sup>, Başak Bulut Karageyik<sup>1</sup>, Uğur Karabey<sup>1</sup>**

1 Hacettepe University, Faculty of Science, Department of Actuarial Sciences, 06800,  
Ankara, Turkey

\*Corresponding author e-mail: mertcankurtcu@hacettepe.edu.tr

***Abstract***

*In the realm of stock market investments, achieving returns surpassing market indices is a coveted objective. This study proposes a new ratio aimed at achieving above-index returns in the stock market, with its performance assessed through iterative analysis using past data and considering its potential application in future datasets. This ratio investigates performance assessment that is affected by currency fluctuations, with a focus on attaining the best feasible portfolio allocation. The analysis employs the XU30 index's real data spanning from 2018 to 2024 as a benchmark for comparison. The findings contribute to the ongoing discourse on quantitative analysis methodologies in financial markets and offer practical implications for investors seeking enhanced returns.*

**Keywords:** Asset Allocation, Portfolio Optimization, Performance Measurement Ratio, XU30



## Analysis of Artificial Intelligence Methods in Classifying Heart Attack Risk: Black-box Models vs. Glass-box Models

Ebru Geçici<sup>1</sup>, Eyüp Ensar Işık<sup>1\*</sup>, Mısra Şimşir<sup>1</sup>, Mehmet Güneş<sup>1</sup>

<sup>1</sup> Yildiz Technical University, Faculty of Mechanical Engineering, Industrial Engineering Department, 34349, İstanbul, Türkiye

\*Corresponding author e-mail: eisik@yildiz.edu.tr

### *Abstract*

*Artificial Intelligence (AI) is becoming increasingly involved in human life daily, and the diversity of its application areas is increasing. The healthcare sector is one of the areas where AI has been widely used recently. For example, in the healthcare sector, AI helps doctors diagnose diseases and provide preliminary information, and it is also used to predict and classify illnesses that individuals may experience in the future. Classification of heart attack risk, the subject of this study, is among the studies to which AI can be applied. While carrying out these studies, techniques such as machine learning, artificial neural networks, or deep learning are used, and high-accuracy results can be obtained. Despite this, the fact that many of the methods used are defined as black-box methods, that is, where the results obtained from the model cannot be explained retrospectively, causes AI to be entirely still not trusted. Thus, studies on explainable AI (XAI) methods aiming to provide local explanations for complex models created globally have increased rapidly in recent years. Explaining the models and results will increase confidence in AI applications. Based on this, methods defined as glass-box may be preferred. However, in this case, the prediction accuracy is expected to be lower compared to models with a complex structure. In this context, it is crucial to choose a model that provides the balance between prediction accuracy and explainability, especially in AI applications in critical sectors such as the healthcare sector. In addition, although it is essential to explain the models created in general, it is also of great importance to be able to provide individual explanations for the predictions made, especially in applications in the field of health. In this study, we will try to determine whether patients are at risk of experiencing a heart attack, considering their characteristics such as age and gender, as well as disease history values that may affect the risk of heart attacks, such as chest pain type, cholesterol, and sugar levels. In addition to logistic regression, naive Bayes, and decision tree models, black box methods such as multi-layer perceptrons and gradient boosting will be used for prediction. The methods used will be examined and compared in terms of explainability as well as prediction accuracy. In addition, the individual explanatory power of the models is another performance indicator to be examined. The results obtained in this context will guide healthcare stakeholders in choosing the most appropriate model among the models created to assist them in their decision-making processes.*

**Keywords:** Artificial Learning, Explainable Artificial Intelligence, Classification, Healthcare Industry

## Bulanık Kümeleme Yöntemleri Yapay Zekâ Uygulamalarında Neden Önemli?

**Baki Yıldız<sup>1\*</sup>, Nihat Tak<sup>1</sup>**

<sup>1</sup> Marmara Universty, İstanbul, Türkiye

\*Sorumlu yazar e-mail: bakiyildizz@outlook.com

### Özet

*Bu çalışma, insanların yaşayış biçimlerini ve psikolojilerini anlamak için kümeleme yöntemlerinin tarihsel gelişimini ve günümüzdeki yapay zeka uygulamalarını ele alıyor. İlk olarak, insan zihninin bilgiyi kategorilere ayırarak işleme eğilimini ardından kümelemenin psikolojide ve sosyolojideki kullanımını incelenecektir. Daha sonra, kümeleme yöntemlerinin tarih boyunca nasıl geliştiği, matematiksel kümeleme teorisinin doğuşu, İstatistik ve bilgisayar bilimleriyle olan etkileşimi gözden geçirilecektir. Ayrıca, bulanık kümeleme kavramının ortaya çıkışı ve insan davranışlarının karmaşıklığını modellemek için nasıl kullanılabileceği de ele alınacaktır. Yapay zeka uygulamalarının çıktı üretme konusunda neden bulanık kümelemeye ihtiyaç duyduğu, değişen koşullara göre çıktuların hangi bağlamda farklılaşabileceği hakkında bulanık kümelemenin önemine vurgu yapılacaktır. Sunumun hedefi istatistik, psikoloji, sosyoloji, bilgisayar bilimleri ve veri bilimi gibi alanlarda çalışan veya ilgi duyan herkesi kapsamaktadır. R programlama dilinde bulanık kümeleme fonksiyonları bulanık bazı kütüphaneler kullanılarak k-means (K - ortalamalar) ve fuzzy c-means (Bulanık C – ortalamalar) yöntemleriyle veri setlerine klasik ve bulanık kümeleme işlemleri uygulanmıştır. Uygulama verisi olarak "kaggle" dan elde edilen NBA ve Hava Kirliliği veri setleri kullanılmıştır.*

**Anahtar Kelimeler:** Kümeleme Teorisi, Bulanık Kümeleme, K-means, Fuzzy C-means, Yapay Zekâ, İnsan Davranışı, Sosyoloji, Veri Bilimi, Veri Analizi



**Asymptotic Results for a Modification of Renewal-reward Process with Normal Distributed Interference of Chance and Delay**

**Aynura Poladova<sup>1\*</sup>, Zulfıye Hanalıođlu<sup>2</sup>, Tahir Khanıyev<sup>3</sup>**

<sup>1</sup> TOBB University of Economics and Technology, Faculty of Engineering, Department of Industrial Engineering, 06560, Ankara, Turkey

<sup>2</sup> Karabuk University, Faculty of Business Administration, Department of Actuarial Sciences, 78050, Karabuk, Turkey

<sup>3</sup> Azerbaijan State University of Economics, The Center of Digital Economics, AZ1001, Baku, Azerbaijan

\*Corresponding author e-mail: apoladova@etu.edu.tr

***Abstract***

*This study considers a modification of renewal-reward process  $(X(t))$  with a truncated normal distributed interference of chance and delay. The ergodicity of the process  $X(t)$  is proven under some weak conditions. Exact expressions for the ergodic distribution and its moments of this process are also obtained. The article analyzes the asymptotic behavior of all moments of the ergodic distribution of the process using Laplace and Laplace-Stiltıjes transforms. As a result of the analysis, two-term asymptotic expansions have been revealed for the moments of the ergodic distribution of the process  $X(t)$ . To demonstrate the accuracy of the asymptotic results, a special example is considered.*

**Keywords:** *Renewal-Reward Process, Normal Distributed Interference of Chance, Moments of Ergodic Distribution, Asymptotic Expansion*

## Bayesian Hierarchical Analyses for Entrepreneurial Intention Of Students

**Mesfin Mulu Ayalew**<sup>1\*</sup>

<sup>1</sup> Bahir Dar University

\*Corresponding author e-mail: m2mulu@gmail.com

### **Abstract**

*In recent years, entrepreneurship has become an important issue due to national economic development and the contribution of society. Data with a hierarchical structure received more attention and occur frequently in social science, public health and epidemiological researches. In such research, binary outcomes are common. Multilevel logistic regression models allow one to account for the clustering of subjects within clusters of higher-level units when estimating the effect of subject and cluster characteristics on subject outcomes. Traditional logistic regression is inappropriate when data are hierarchically structured. Therefore, this study presents multi-level Bayesian logistic analysis for entrepreneurial intention of students using classical and Bayesian approach. The descriptive result revealed that about 57.4% of the students had an entrepreneurial intention while 42.6% do not have an intention. The results also showed that entrepreneurial education/training and entrepreneurial attitudes significantly predicts students' entrepreneurial intention at 5% level of significance. The model results indicate that the effects of the selected variable on entrepreneurial intention vary across university. By failing to take into account the clustering within university (level 2), Bayesian multilevel effects are not taken into consideration in modeling, the  $\beta$  coefficients in multilevel logistic model using classical approach are distorted somewhat in both directions either in over or under direction. This study also evaluates and compares the behavior of maximum likelihood and Bayesian estimators to investigate the relationship between covariates and the response. Both point and interval estimation performances were investigated. The results revealed that lower standard errors of the estimated coefficients in the Bayesian logistic regression approach as compared to classical approach. Moreover, the results revealed that the length of the Bayesian credible interval is smaller than the length of the maximum likelihood confidence interval for all factors. In order to identify the most plausible method between Bayesian method and maximum likelihood estimation of the data, AIC, BIC and DIC are adopted in this paper. The result of the study depicts that the Bayesian method performs better and more efficient than maximum likelihood estimation. The study recommends that the government as well as the universities should design programs that facilitate entrepreneurship to change the mindset, attitude, and intention of those students who do not have knowhow about entrepreneurship as a future career.*

**Keywords:** Multilevel analysis, Hierarchical models, Bayesian approach, Cluster data, Entrepreneurial intention, Students

## CQI-8 Level Process Audit (LPA) in a Factory in the Tire Industry

Akın Bahattin Şen<sup>1</sup>, Esra Aktas<sup>2\*</sup>

<sup>1</sup> Karabük University, Department of Industrial Engineering, 78050, Karabük, Türkiye

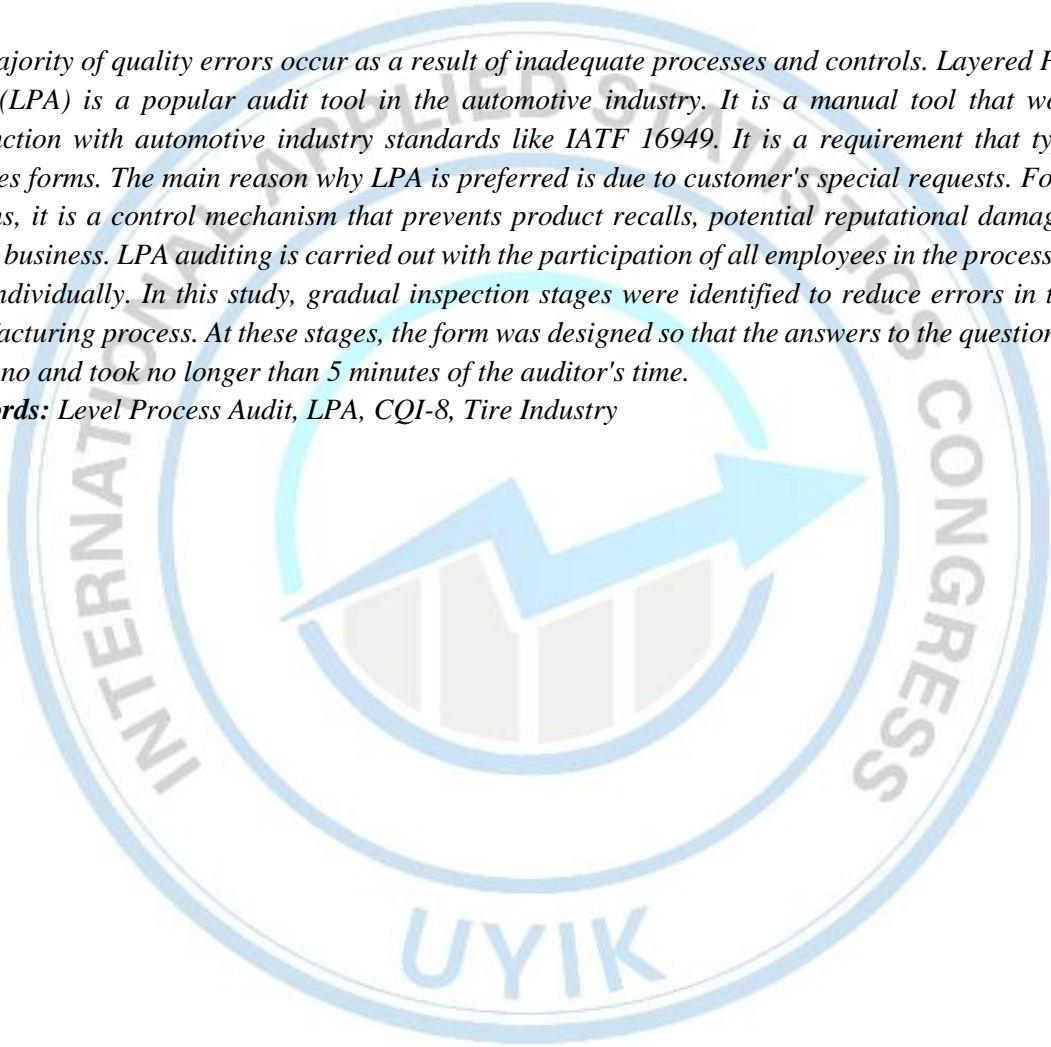
<sup>2</sup> Gümüşhane University, Department of Occupational Health and Safety, 29000, Gümüşhane, Türkiye

\*Corresponding author e-mail: esraaktas29@gmail.com

### *Abstract*

*The majority of quality errors occur as a result of inadequate processes and controls. Layered Process Audit (LPA) is a popular audit tool in the automotive industry. It is a manual tool that works in conjunction with automotive industry standards like IATF 16949. It is a requirement that typically includes forms. The main reason why LPA is preferred is due to customer's special requests. For these reasons, it is a control mechanism that prevents product recalls, potential reputational damage, and repeat business. LPA auditing is carried out with the participation of all employees in the process rather than individually. In this study, gradual inspection stages were identified to reduce errors in the tire manufacturing process. At these stages, the form was designed so that the answers to the questions were yes or no and took no longer than 5 minutes of the auditor's time.*

**Keywords:** Level Process Audit, LPA, CQI-8, Tire Industry





## Çok Kriterli Karar Verme Yöntemi ile Elektrikli Otobüs Seçimi

Sinem Besirli Tapu<sup>1</sup>, Adnan Corum<sup>1\*</sup>

<sup>1</sup>Bahcesehir University

\*Sorumlu yazar e-mail: dnan.corum@bau.edu.tr

### Özet

*Bu çalışma, ulaşım alternatiflerinden olan toplu taşıma, günümüz koşulları, küresel ısınma da göz önüne alındığında öncelikli bir tercih haline gelmiştir. Fosil yakıtların ulaşımında kullanılması ile oluşan, küresel ısınma sebebi olan sera gazı etkisinden uzaklaşmak, fosil yakıtlı araçlara alternatif olarak sıfır emisyonu sahip olan elektrikli araçlara yönelmek, aynı zamanda hem toplu taşımayı hem de elektrikli araç kavramını bir araya getiren elektrikli otobüsler ön plana çıkmaya başlamıştır. Bu çalışmada uzman görüşleri ile belirlenen kriterler dahilinde çok kriterli karar verme yöntemlerinden analitik hiyerarşi proses kullanılarak, kriter önceliklendirmesi, uzman görüşlerinden faydalanılarak yapılmış, tutarlılık oranları kontrolleri sonucu en verimli ulaşım alternatiflerinden olan elektrikli otobüs seçimi belirlenen kritere göre yapılmıştır.*

**Anahtar Kelimeler:** AHP, Elektrikli Otobüs Seçimi, Batarya Teknolojisi, Otonom Elektrikli Otobüs, Hidrojenli Otobüs

**Karesel Tablolarda MDR Tekniđi ve Simetri Modellerinin Karşılaştırması**

**Gökçen Altun**<sup>1\*</sup>

<sup>1</sup> Ankara Hacı Bayram Veli University, Faculty of Economics and Administration, Department of Econometrics, Ankara, Turkey

\*Sorumlu yazar e-mail: gokcenefendioglu@gmail.com

**Özet**

*Karesel olumsuzluk tabloları bağımlı örneklemelerde ortaya çıkan, satır ve sütun değişkenleri aynı düzeylere sahip olan çapraz tablolarıdır. Bu tablolarının çözümlenmesinde bazı özel modeller kullanılır. Bu modeller çoğunlukla simetri modelleridir. Multifactor Dimensionality Reduction (MDR) tekniđi ise bir çok etkenli boyut indirgeme yöntemidir. MDR parametrik olmayan bir yöntem olması, herhangi bir matematiksel model varsayımı gerektirmemesi gibi özellikleri bakımından oldukça kullanışlıdır. Özellikle sağlık verilerinde kullanılan bu teknik teorik ve pratik alanda yapılan çalışmalarla kendini ispat etmiştir. Karesel tablo çözümlenmesinde kullanılan Simetri, Marjinal Homojenlik modelleri tabloların yorumlanmasına ve sayısal sonuçlarla desteklenmesine olanak sağlamaktadır. Bu çalışmada karesel formda olan veri kümeleri hem MDR tekniđi ile incelenmiş hem de modeller aracılığı ile analiz edilmiş ve sonuçlar karşılaştırılmıştır.*

**Anahtar Kelimeler:** Karesel tablo, MDR tekniđi, Simetri modelleri

**On Function-on-Function Partial Quantile Regression**

**Müge Mutis<sup>1\*</sup>, Ufuk Beyaztaş<sup>2</sup>, Filiz Karaman<sup>1</sup>, Hanlin Shang<sup>3</sup>**

<sup>1</sup>Yildiz Technical University, Department of Statistics, 34000, Istanbul, Turkey

<sup>2</sup>Marmara University, Department of Statistics, 34000, Istanbul, Turkey

<sup>3</sup>Macquarie University, Department of Actuarial Studies and Business Analytics, 2000, Sydney, Australia

\*Corresponding author e-mail: muge.mutis@yildiz.edu.tr

***Abstract***

*We present two innovative functional partial quantile regression algorithms designed to accurately and efficiently estimate the regression coefficient function within the function-on-function linear quantile regression model. Our algorithms utilize functional partial quantile regression decomposition to effectively project the infinite-dimensional response and predictor variables onto a finite-dimensional space. Within this framework, the partial quantile regression components are approximated using a basis expansion approach. Consequently, we approximate the infinite-dimensional function-on-function linear quantile regression model using a multivariate quantile regression model constructed from these partial quantile regression components. To evaluate the efficacy of our proposed techniques, we conduct a series of Monte Carlo experiments and analyze an empirical dataset, demonstrating superior performance compared to existing methods in finite-sample scenarios. Our techniques have been implemented in the ffpqr package in R.*

**Keywords:** *Basis expansion functions, Function-on-function linear quantile regression, Functional partial least squares regression, Quantile covariance, Quantile regression*



## Çanakkale'de Rüzgâr Enerji Santrali Kurulum Yerlerinin Mekânsal Analizi

**Mehmet Burak Bartan<sup>1\*</sup>, Özlem Türkşen<sup>2</sup>**

<sup>1</sup>Ankara Üniversitesi, Fen Bilimleri Enstitüsü, İstatistik ABD, 06100, Ankara, Türkiye

<sup>2</sup>Ankara Üniversitesi, Fen Fakültesi, İstatistik Bölümü, 06100, Ankara, Türkiye

\*Sorumlu yazar e-mail: mehmetburakbartan@gmail.com

### Özet

*Sürdürülebilirlik, olumsuz etkiler ve arz güvenliği gibi faktörler enerji kaynakları konusunda büyük önem taşıyor. Yenilebilir enerji kaynakları, doğal olarak sürdürülebilir ve sınırsız biçimdeki kaynaklardır. Yenilebilir enerji kaynaklarından biri olan rüzgarın etkin kullanımı konusunda enerjinin artırılması amacıyla yönlendirilmiş enerji santrali (RES) yerlerinin biçimsel olarak uygun belirlenmesi gereklidir. Bu başarıyı elde eden yer alan RES'lerin en yoğun olduğu illerden biri olan Çanakkale'de RES kurulumu üzerine mekansal analiz yapılmıştır. Analizde kullanılan veriler Orman ve Su İşleri Bakanlığı, Yenilenebilir Enerji Genel Müdürlüğü, Enerji Piyasaları Denetleme Kurumundan vektör olarak elde edilirken, Global Wind Atlas, CORINE, Openstreetmap web sitelerinden ise raster veri tipinde temin edilmiştir. Yapılan kapsamlı analiz çalışmaları dikkate alınarak RES'lerin kurulum yerlerine ilişkin olası kesintiler, korunan alanlara uzaklık, yerleşim yerlerine uzaklık, göller ve barajlar, akarsuya uzaklık gibi kiralarda birlikte, enerji hattına ve trafoya uzaklık, rüzgar kapasitesi faktörü, rüzgar hızı gibi teknik kısıtlamalar olarak belirlendi. Çanakkale ili üzerinde kısıtlamalara göre uygun olmayan alanlara, ArcGIS programı aracılığıyla görselleştirilip eleme yöntemiyle çıkarılmıştır. Mekansal analiz sonucunda kaydedilen alanlar nokta veriye dönüştürülerek Çok Ölçümlü Karar Verme Yöntemleri uygulanıp RES kurulumu için uygun alanlarda kaydedilen önem derecelerine göre sıralanmıştır.*

**Anahtar Kelimeler:** Vektör Veri, Raster Veri, Mekânsal Veri Analizi, Çok Ölçümlü Karar Verme, Rüzgâr Enerji Santrali (RES)

## Ham Petrol Fiyatlarının Makroekonomik Göstergeler Üzerindeki Etkileri: Favar Yaklaşımı

**Fulya Gezer<sup>1\*</sup>**

<sup>1</sup> Ankara Hacı Bayram Veli University, Faculty of Economics and Administrative Sciences,  
Department of Econometrics, 06500, Ankara, Türkiye

\*Sorumlu yazar e-mail: fulya.gezer@hbv.edu.tr

### Özet

*Sims (1980) tarafından tanımlanan VAR modeller, makroekonomik değişkenler arasındaki dinamik ilişkileri modellemek için popüler bir araçtır. Geleneksel VAR modellerde, çok sayıda değişken, çok sayıda gecikme ile birleştiğinde, aşırı parametrelendirmeye ve serbestlik derecelerinin tükenmesine yol açacağı için örneklem dönemi boyunca yalnızca az sayıda değişkenin ortalama etkilerinin araştırılması amaçlanmaktadır. Ancak, ihmal edilen değişken yanlılığından kaçınmak ve makroekonomik değişkenler arasındaki karmaşık ilişkileri modellemek için daha fazla değişken gerekli olabilmektedir. Bernanke, Boivin ve Eliasız (2004), VAR yaklaşımını kullanırken seyrek bilgi kümesi sorunlarının üstesinden gelmek için çok sayıda makro değişkenleri barındırabilen FAVAR yaklaşımını önermişlerdir. FAVAR yaklaşımı, büyük veri setinden elde edilen bilgilerden yararlanmak için faktör analizini standart VAR analizi ile birleştirmektedir. Bu çalışmada, Türkiye için petrol fiyatındaki değişimlerin makroekonomik göstergeler üzerindeki etkileri hem VAR model hem de FAVAR model ile analiz edilerek araştırılmış ve elde edilen sonuçlar karşılaştırılmıştır.*

**Anahtar Kelimeler:** VAR, FAVAR, Petrol fiyat şokları

## Aykırı Değer Tespitinde Kategorik Veri Kümeleme

**Oğuz Kaan Kılıç<sup>1\*</sup>**

<sup>1</sup>Gazi Üniversitesi, Ankara, Türkiye

\*Sorumlu yazar e-mail: oguzkaankilic@yahoo.com

### Özet

Teknolojinin gelişimi, yıllar içerisinde veriyle ilgili pek çok kavram ve yöntemin geliştirilmesini sağlamıştır. Bunlardan birisi de özellikle son yıllarda popülerliği giderek artan Veri Madenciliği (VM) alanıdır. Dünyada her gün çeşitli kaynaklardan milyonlarca veri üretilmektedir. Bu verilerin nasıl kullanılacağı ve değerlendirileceği VM'nin bir konusu haline gelmiştir. VM' de amaç geçmiş verilerden çıkarılan bilgiler ışığında gelecekle ilgili kararların en doğru şekilde alınmasıdır. VM sayesinde büyük veri yapılarındaki örüntüler ve ilişkiler ortaya çıkarılır ve bunlardan kritik bilgiler elde edilebilir. VM; İstatistik, Matematik, Yapay Zeka, Bilgi Teknolojileri, Makine Öğrenmesi gibi farklı disiplinlerin bir arada kullanılmasını içermektedir. Yapılan çalışmanın amacına bağlı olarak, bu disiplinler bazen tek başına bazen de çeşitli kombinasyonlar halinde birlikte kullanılabilirler. Bu disiplinlerin varlığı sayesinde VM içerisinde pek çok tekniğin kullanılmasını da mümkün kılmaktadır. Sınıflandırma, Kümeleme, Regresyon, Karar Ağaçları, Sinir Ağları gibi istatistiksel yöntemler VM içerisinde yaygın olarak kullanılırlar. Bu istatistiksel yöntemlerin uygulanabilmesi için içerisinde uygun miktarda veriden oluşan en az bir adet veri setine ve bununla yapılmak istenen bir amaca ihtiyaç duyulmaktadır. Veri setleri genellikle nümerik, kategorik veya her ikisinin bir arada bulunduğu verilerden oluşmaktadır. Ancak günümüzde veri setlerinde bulunan verilerin sayısı artmış, bunların sürekli olarak takip edilmesi zorlaşmıştır. Buldukları veri setlerindeki standartlardan büyük ölçüde sapma gösteren veri tiplerine "Aykırı Değer" denilmektedir. Son yıllarda VM alanında karşılaşılan problemlerden birisi de aykırı değerlerin tespit edilmesi olmuştur. Veri setleri içerisinde bulunan aykırı değerlerin tespit edilmeleri doğru kararların alınabilmesi adına önemli bir durum haline gelmiştir. Bugüne kadar yapılan çalışmalarda, genellikle nümerik veriler içeren veri setleri üzerinde aykırı değerlerin tespit edilmesi çalışması yapılmıştır. Aykırı değer tespitinde kategorik verilerden oluşan veri setleri için geliştirilen istatistiksel teknikler ise az sayıdadır. Ancak günümüzde veri setlerini oluşturan verilerin birçoğu kategoriktir. &nbsp;Bu çalışmada kümeleme algoritmaları yardımıyla kategorik verilerde aykırı değer tespitinde bulunulacaktır.

**Anahtar Kelimeler:** Veri Madenciliği; Kategorik Veri; Aykırı Değer; Kümeleme Algoritmaları



## Ranking of European Airports According to Sentiment Scores

**Serhan Karadeniz<sup>1\*</sup>, Beyza Özkök<sup>2</sup>**

<sup>1</sup>Beykoz University, School of Civil Aviation, Aviation Management Department, 34805, İstanbul, Türkiye

<sup>2</sup>Yıldız Technical University, Faculty of Economics and Administrative Sciences, Department of Business Administration, 34220, İstanbul, Türkiye

\*Corresponding author e-mail: serhankdeniz@gmail.com

### ***Abstract***

*The aviation sector is characterized by fierce competition and rapid expansion. Effective management of airports requires a deep understanding of passenger sentiments and responsive actions. Serving as crucial infrastructure for air travel, airports play a pivotal role across various stages of the transportation value chain, contributing significantly to their development. Airline companies, recognizing that passengers satisfied with service quality tend to spend more, have embarked on a quest to improve their services. This study endeavors to employ natural language processing techniques to analyze customer feedback for major European airports with annual passenger traffic exceeding 20 million. A comprehensive review of 9,607 passenger evaluations spanning 21 airports was conducted. The analysis yielded a sentiment score ranking for these airports, shedding light on customer perceptions and expectations. Remarkably, Athens International Airport emerged as the top-ranked airport in Europe based on sentiment scores, whereas London Stansted Airport received the lowest ranking. The frequent repetition of words such as "Security", "Staff", "Time", "Check", "Departure", "Queue", "Hour", "Minute" in frequency analysis corroborates this situation. It has been observed that the majority of the most frequently occurring words are those that connote negativity. Furthermore, frequent word analysis revealed recurring themes such as 'Delay,' 'Positive Aspects,' and 'Manchester Passenger Dissatisfaction' through topic modeling. By leveraging these insights, the study aims to derive actionable recommendations from passenger reviews, underscoring the significance of qualitative methodologies in airport management.*

**Keywords:** Airports, Sentiment Analysis, Topic Modelling, Feedback, Service Quality

## Data Mining in Dietary Pattern Analysis

Gonca Yildirim<sup>1\*</sup>

<sup>1</sup>Toros University, Faculty of Health Science, Nutrition and Dietetics, 33140, Mersin, Türkiye

\*Corresponding author e-mail: gncyildirim@gmail.com

### *Abstract*

*People typically eat a range of foods that interact with one another rather than one food in isolation. As a result, when doing statistical analyses on a single nutrient or nutrient group, significant associations may emerge by chance. Dietary pattern describes real-life nutritional behavior, including food consumption habits, dietary components, and interactions between these components, in which meals are taken in a variety of distinctive combinations. Dietary pattern analysis is a method of dietary analysis that considers the cumulative and interactive effects of dietary components, reflecting the complexity of the human diet. It has long been used in nutritional epidemiological research to generate evidence for disease risk and prevention and to establish nutritional guidelines. Dietary pattern is evaluated either theoretically by grouping according to a priori criteria related to nutritional health, or posteriori by reducing it to fewer variables with statistical methods. Hybrid analysis, is a method that combines both theoretical and predictive variables to tailor it for a specific purpose. Here, it is aimed to determine the potential use of data mining (DM), considered one of the hybrid methods in comprehensive diet pattern analysis. Non-systematic literature searching was conducted using the keywords dietary pattern, meal pattern, nutrition pattern, nutritional data analysis, and data mining. Based on the gathered information, DM emerges as a notable approach in dietary pattern research, considering health outcomes when identifying nutritional patterns. DM is used to model an output variable based on one or more input variables such as a biomarker or an index that measures diet quality in order to discover patterns and relationships in nutritional data. Unlike traditional statistical approaches such as multiple regression, DM allows multiple nonlinear relationships and interaction effects to be captured efficiently. It can derive nutritional patterns using analytical modelling, classification and extrapolation of information from collected nutritional data and make accurate decisions based on associations of pattern-based risk factors. Current research on dietary pattern analysis uses methods such as classifiers, artificial neural networks and decision trees. These methods can be used to understand the extent to which the dietary patterns of healthy and unhealthy individuals differ as well as the apparent heterogeneities in the dietary behavior of the population. It can predict the impact of factors such as eating habits, frequency of eating, number of portions and types of food consumed on the emergence of obesity and chronic diseases as a pattern. It can help determine the dietary history information needed to develop dietary recommendations. Additionally, DM techniques can provide a more comprehensive analysis by integrating various data sources including demographic information, lifestyle habits, genetic information, health records along with dietary pattern. DM may fill a methodological gap and provide new insights by introducing new perspectives to dietary pattern analysis. However, translating long and complex rules into simple health information during the DM process requires significant professional knowledge.*

**Keywords:** Dietary pattern analysis, Data mining, Nutritional epidemiology

**Examination of Hotel Reviews Using Text Mining and Natural Language Processing Methods**

**Orkun Enes Balaban<sup>1\*</sup>, Deniz Özönur<sup>1</sup>**

<sup>1</sup>Gazi University, Graduate School of Natural and Applied Sciences, Department of Statistics, 06500, Ankara, Türkiye

<sup>2</sup>Gazi University, Faculty of Science, Department of Statistics, 06500, Ankara, Türkiye

\*Corresponding author e-mail: orkun\_enes06@hotmail.com

***Abstract***

*Customer satisfaction is critical to the profitability of the business. In this study, text mining and natural language processing techniques, which are rarely applied to Turkish data in the literature, were used to analyze the comments made by hotel customers. The comments of the users on the Tripadvisor site regarding 33 hotels with 5 stars and less than 5 stars in the Manavgat, Alanya, and Kemer regions of Antalya were examined. By applying text mining and natural language processing algorithms to the collected data, feature extractions were made, classification performances were compared, sentiment analysis was performed using the NRC sentiment word dictionary, and text link analysis was performed. According to the findings, the comments in the data set include eight different emotions in the emotion dictionary. The words "exist" and "not exist" were chosen for text link analysis. Text link analysis results show that the words "exist" and "not exist" reflect both positive and negative expressions. Finally, different classification algorithms were applied to Turkish comments obtained from users according to different feature extraction methods used in the literature. The performances of the classification algorithms were obtained and the travel type label was predicted.*

**Keywords:** *Text mining, Natural language processing, Sentiment analysis, Classification, Customer reviews*



Yapay Öğrenme ile Kredi Ödenebilirliğinin Tahmini: Bir Veri Bilimi Yaklaşımı

**Burak Yüksel<sup>1\*</sup>, Tuna Çakar<sup>2</sup>, Özden Gebizoğlu Özvural<sup>1</sup>**

<sup>1</sup> Koç Finansman A.Ş.

<sup>2</sup> Mef Üniversitesi

\*Corresponding author e-mail: byuksel@kocfinans.com.tr

**Özet**

*Bu çalışma, kredi ödenabilirliğini tahmin etmek için yapay öğrenme tabanlı bir veri bilimi modeli geliştirmeyi amaçlamaktadır. Kredi sağlayıcılarının, borç alıcıların mali durumlarını değerlendirmesinde kritik bir faktör olan ödenabilirlik, gelir ve varlık durumlarına odaklanan metriklerle analiz edilmiştir. Araştırmada, kredi kartı limitleri, risk değerlendirmeleri ve ödeme performansı gibi farklı veri kaynaklarından oluşturulan geniş bir veri seti kullanılmıştır. Veri ön işleme ve öznelik mühendisliği yöntemlerinin uygulanmasının ardından Lineer Regresyon, Rastgele Orman, XGBoost gibi algoritmalar kullanılarak veri-güdümlü tahmin modelleri geliştirilmiştir. Elde edilen bulgular, ödeme gücünü etkileyen önemli öznelikleri ortaya koymuş ve XGBoost modeli en iyi performansı göstermiştir. Bu çalışma, akademik literatüre doğrudan katkıda bulunmayı ve sektörel çalışmalara somut şekilde katkıda bulunmayı hedeflemektedir.*

**Anahtar Kelimeler:** kredi skorlama, alternatif veri kaynakları, kredi ödenabilirliği, yapay öğrenme

## Estimating Air Pollution in Istanbul Through Machine Learning Techniques

**Taylan Valunya<sup>1\*</sup>, Coşkun Parim<sup>1</sup>, Filiz Karaman<sup>1</sup>**

<sup>1</sup>Yildiz Technical University, Faculty of Art & Science, Statistics, Istanbul, Türkiye

\*Corresponding author e-mail: taylanvalunya@hotmail.com

### ***Abstract***

*Effectively mitigating air pollution and its adverse effects on ecosystems necessitates routine monitoring of air pollutant levels alongside meteorological data. This task presents notable challenges, particularly in densely populated urban areas and regions with concentrated industrial activities. This study focuses on employing machine learning techniques to estimate the concentration of Particulate Matter (PM10), a key air pollutant, using hourly data collected between 2018 and 2020 from a monitoring station situated in Başakşehir, Istanbul—one of Türkiye's and the world's largest metropolises. In addition to PM10, other air pollutants including SO<sub>2</sub> (Sulfur dioxide), NO (Nitric oxide), NO<sub>2</sub> (Nitrogen dioxide), NO<sub>x</sub> (Nitrogen oxides), and O<sub>3</sub> (Ozone) are considered, alongside meteorological variables such as air temperature, wind direction, wind speed, relative humidity, and air pressure. The dataset is chronologically divided into 70% for training and 30% for test. Subsequently, feature selection techniques are applied to identify the most relevant variables. Various machine learning algorithms are then employed to estimate PM10 concentrations. The performance of these models is evaluated using metrics such as R<sup>2</sup>, MSE, and MAE. Ultimately, this study compares the performance of different machine learning models to determine the most effective approach and variables for estimating PM10 concentrations.*

**Keywords:** PM10, Air Temperature, Wind Direction, SO<sub>2</sub>, Machine Learning

## Makine Öğrenme Algoritmaları ile Müzikte Duygu Sınıflandırması

Filiz Kanbay<sup>1</sup>, Güller Keskin<sup>1\*</sup>

<sup>1</sup>Yıldız Teknik Üniversitesi, Fen Bilimleri Enstitüsü, 3400, Türkiye, İstanbul

\*Sorumlu yazar e-mail: gulleryesilbudak10@gmail.com

### Özet

Finans, sağlık, eğitim gibi birçok alanda sınıflandırma, kümeleme tahmin gibi amaçlarla kullanılan makine öğrenmesi müzik konusunda da birçok çalışmaya konu olmuştur. Bu çalışmada UCI machine learning Repository sitesinden 50 öznitelik, 4 sınıf etiketi 400 birimden oluşan “ Turkish Music Emotion” adlı kayıp verisi bulunmayan veri seti kullanılarak sınıflandırma için matematiksel modellemeler oluşturulmuştur. Bu amaçla KNN, Naive Bayes, Karar ağaçları, Rastgele orman, Boosting(AdaBoost, XGBoost) sınıflandırma algoritmaları incelenmiştir. Algoritmaların hiperparametreleri için, kurulan matematiksel model başarılarının maksimize edilmesi amacı ile ızgara taraması yapılmıştır. Yapılacak işlemler için Anaconda ortamında, Jupiter Notebook uygulaması ile Python araçları kullanılmıştır. İncelenen algoritmaların model başarıları özetlenmiştir.

**Anahtar Kelimeler:** Makine öğrenim algoritmaları, Müzikte duygu sınıflandırması, Model başarı ölçütü.





## Makine Öğrenmesi Yöntemleri ve Performans Analizi

**Elif Aksoy<sup>1\*</sup>, Filiz Kanbay<sup>1</sup>**

<sup>1</sup>Yıldız Teknik Üniversitesi, Fen Bilimleri Enstitüsü, İstanbul, Türkiye

\*Sorumlu yazar e-mail: elif.aksoy3@std.yildiz.edu.tr

### Özet

Günümüzde finans, sağlık, ticaret ve eğitim gibi birçok alanda makine öğrenmesi yöntemleri ve veri analizi ile birçok araştırma yapılmaktadır. Bu çalışma öğrencilerin eğitim başarısını etkileyen demografik bilgileri modellemeyi hedeflemektedir. Bu amaçla UC Irvine Machine Learning Repository sitesinden 32 özniteliğe ve 18 sınıf etiketine sahip Portekizce ve Matematik derslerine ait sırasıyla 649 ve 395 birim içeren “Öğrenci Performansı” adlı veri setinin matematik dersi ile ilgili sonuçlar ele alınmıştır. Pythonda jupyterLab ortamı kullanılarak Naive Bayes, K- En Yakın Komşu Algoritması, Karar Ağaçları, Rastgele Orman, Destek Vektör Makineleri ve Adaboost algoritmaları ile matematiksel modellemeler oluşturulmuştur. Kullanılan matematiksel modellerin hiperparametreleri Izgara Taraması (Gridsearch) ile belirlenmiş ve elde edilen model başarıları özetlenmiştir. **Anahtar Kelimeler:** Makine öğrenmesi, Karar Ağaçları, Rastgele Orman Algoritması



## Üniversite Öğrencilerinin Saldırganlık Düzeylerini Etkileyen Faktörler

**Burçin Öner<sup>1\*</sup>, Kubra Taşçı<sup>2</sup>**

<sup>1</sup>Bilecik Şeyh Edebali University, Bozuyuk Vocational High School, Banking and Insurance Programme, 11300, Bilecik, Türkiye

<sup>2</sup>Ondokuz Mayıs University, Faculty of Science, Department of Statistics, 55200, Samsun, Türkiye

\*Sorumlu yazar e-mail: burcin.oner@bilecik.edu.tr

### Özet

*Bir toplumun ekonomik, sosyal ve kültürel sorunlarının ifadesi, aile içinde aile üyeleri arasında öfke veya saldırganlık olarak kendini gösterebilir. Bu bağlamda öfke ve saldırganlık günümüz toplumlarının karşılaştığı önemli sorunlardır. Bu çalışma, Samsun Ondokuz Mayıs Üniversitesi özelinde üniversite öğrencilerinin saldırganlık düzeylerini etkileyen faktörleri belirlemeyi amaçlamaktadır. Bu amaç doğrultusunda araştırmanın evrenini 2022-2023 eğitim-öğretim yılında Ondokuz Mayıs Üniversitesi'nde (OMÜ) önlisans, lisans ve yüksek lisans programlarına kayıtlı öğrenciler oluşturmaktadır. Araştırma verileri G-Power 3.1.9.7 güç analizi programıyla belirlenen 570 birimlik örneklemden oluşmaktadır. Bu öğrencilerin öfke ve saldırganlık düzeylerini ölçmek amacıyla "Buss-Perry Saldırganlık Anketi Türkçe Formu" kullanıldı. Bu ölçek her biri öfke ya da saldırganlığa ilişkin farklı ifadeleri kapsayan 29 maddeden oluşmaktadır. Ayrıca veri toplamak amacıyla araştırmacı tarafından geliştirilen 20 sorudan oluşan "Demografik Bilgi Formu" kullanılmıştır. Öğrencilerden alınan 570 yanıt formu incelendikten sonra eksik bilgi içeren 9 form örneklemden çıkarıldı ve 561 yanıt formu analize bırakıldı. Verilerin analizinde IBM SPSS İstatistik 26.0 olarak bilinen istatistik paket programı kullanıldı. Saldırganlık düzeylerini etkileyen faktörlerin belirlenmesi amacıyla Faktör Analizi yöntemi kullanılmıştır. Temel Bileşenler yöntemi ve Varimax faktör döndürme yöntemi kullanılarak uygun bir çarpanlara ayırma modeli önerildi. Analiz ve değerlendirmeler üniversite öğrencilerinin saldırganlık düzeylerini etkileyen altı faktörü ortaya çıkardı. Bu faktörler; öfke kontrol bozukluğu, saldırgan davranışlar, kıskançlık ve güvensizlik, tartışmacı kişilik, şüpheli ve öfkeli kişilik, dürüst ve açık sözlü kişilik olarak modellenmiştir.*

**Anahtar Kelimeler:** Saldırganlık, Ölçek, Faktör, Faktör Analizi, Varimax Döndürme

**The Evaluation of the Environmental Performance of Eastern European Countries with the Integrated Entropy and Waspas Method**

**Ayşe Elif Yazgan**<sup>1\*</sup>

<sup>1</sup>Necmettin Erbakan University, Faculty Of Applied Sciences, Finance And Banking Department, 42090, Konya, Türkiye

\*Corresponding author e-mail: [ae yazgan@erbakan.edu.tr](mailto:ae yazgan@erbakan.edu.tr)

***Abstract***

*The success of countries in sustainable development depends on the simultaneous adoption of economic, social and environmental factors. In this direction, countries that use their natural resources efficiently, take and implement measures against environmental pollution, and strengthen their environmental performance by realizing effective environmental management will be in a stronger position in the future compared to other countries. With the increase in environmental awareness in recent years, countries have been developing various policies to solve their environmental problems. In order to evaluate these policies efficiently and to see the situation for countries, performance evaluation should be carried out regularly. In this study, the Environmental Performance Index (EPI) is used to assess the environmental performance of countries. EPI is published regularly at two-year intervals by the Joint Research Center of the World Economic Forum and the European Commission under the leadership of Yale and Columbia Universities. The Index is a performance-oriented composite index prepared to measure countries' progress in achieving environmental targets set by taking into account their current environmental policies. By 2022, the index has 3 policy objectives, 11 criteria and 40 indicators. Accordingly, in this study, the environmental performance of 19 Eastern European countries was analyzed based on the Environmental Performance Index values of 2022 by using ENTROPI and WASPAS (Weighted Aggregated Sum Product Assessment) methods from Multi-Criteria Decision Making (MCDM) techniques and the relevant countries were ranked in terms of environmental performance according to the analysis results. Data on the criteria were obtained from the Yale University website. In the study, firstly, the criteria were weighted by ENTROPI method and it was determined that the three most important criteria are water & sanitation, climate change mitigation and ecosystem services. Finally, the environmental performance of Eastern European countries was analyzed according to the WASPAS method. Latvia, Romania and Estonia were found to be the three best performing countries. Turkey ranked 11th among 19 countries.*

**Keywords:** *Environmental Performance, Entropy, Waspas, MCDM, Eastern European Countries*



**PCA Analysis of Data Series from Biodegradation of Alternative Organic Materials Mixtures for Renewable Energy Profit**

**Ilirjan Malollari<sup>1\*</sup>, Eglantina Kalluci<sup>2</sup>, Redi Buzo<sup>3</sup>, Terkida Prifti<sup>1</sup>**

<sup>1</sup>Department of Industrial Chemistry, Faculty of Natural Sciences, University of Tirana, Albania

<sup>2</sup>Department of Applied Mathematics, Faculty of Natural Sciences, University of Tirana, Albania

<sup>3</sup>Department of Biochemistry, University F.S. Noli, Korce, Albania

\*Corresponding author e-mail: ilir.malo@gmail.com

***Abstract***

Worldwide energy demand and concerns about greenhouse gas emissions have fueled international interest in untapped renewable energy sources such as degradable organic materials. In this context, anaerobic digestion offers a useful energy production technology. Organic and food waste constitute a substrate with high energy potential, which can be successfully converted by this suitable technology, such as biochemical fermentation under anaerobic conditions (anaerobic digestion) to produce biogas. This thesis aims to develop an integrated modelling platform in which an anaerobic digestion process can be connected to the operations of other units that serve it. This platform will help maintain the digester's physico-chemical conditions and transform digestion products into valuable fuels and nutrient sources. Anaerobic digestion of food waste, specifically various organic waste from the cultivation of industrial plants (straws), animal manure, dry food waste, etc., was chosen as the research subject due to their growing popularity and the availability of validation data. Like many other organic substrates, food waste is potentially a good source of renewable energy in the form of biogas through anaerobic digestion. Five alternatives of mixtures with different compositions of organic matter and plant and animal waste have been formulated to highlight the main potential components that dominate the process of methanisation of waste for energy benefit. Our research underscores the importance of high efficiency in the operation of a biogas plant that treats food waste. We propose an adequate methodology with alternatives and options, including the application of sophisticated mathematical methods like PCA analysis, non-linear regression, and multi-dimensional. The results obtained from these methods are instrumental in the design, control, and operation of the system, thereby directly impacting the efficiency of biogas plants. In the present study, a simulation model of a biogas plant was used, combining the standardised platform ADM1 and the computer simulation software Aspen Plus to simulate anaerobic digestion with relevant modifications and improvements to match the actual results of organic waste digestion and food. While using food waste, there is a tendency to accumulate intermediate products of volatile fatty acids, particularly propionic acid, which eventually causes a decrease in pH and digestion failure.

**Key words:** PCA Analysis, Anaerobic Biodegradation, Alternative Mixtures, Renewable Energy

## Lineer Olmayan Kesirli Diferansiyel Denklemlerin Varyasyonel İterasyon Metodu ile Çözümü

Eray Yeşilyurt<sup>1\*</sup>

<sup>1</sup>Ege Üniversitesi, Fen Fakültesi, Matematik Bölümü, 35100, İzmir, Türkiye

\*Sorumlu yazar e-mail: erayyesilyurt.34@gmail.com

### Özet

*Bu çalışma, lineer olmayan kesirli diferansiyel denklemlerin Varyasyonel iterasyon metodu kullanılarak elde edilen çözümlerin etkinliğini göstermek amacıyla yapılmıştır. Özellikle mühendislik ve fizik bilimlerinin ilgilendiği birçok problemin en iyi şekilde modellenmesini sağlayan lineer olmayan kesirli diferansiyel denklemlerin çözümleri için güvenilir ve etkin metod arayışları günümüzde artarak devam etmektedir. Çalışmada öncelikle lineer olmayan kesirli diferansiyel denklemlerin çözümlerinde faydalanılan özel fonksiyonlar tanımlanmıştır. Riemann-Liouville ve Caputo türev operatörlerinin tanımları incelenmiştir. Çalışmamızda yer alan uygulama örneklerinde başlangıç koşullarını içeren lineer olmayan kesirli diferansiyel denklemler ele alınmıştır. Bu denklemlerin çözümlerinde daha kullanışlı bir tanım olan Caputo türev operatörü kullanılmıştır. Metodun etkinliğini göstermek üzere incelediğimiz örneklerde lineer olmayan kesirli diferansiyel denklemlerin 2. dereceden türevleri için elde ettiğimiz analitik çözümler ile 1.25, 1.50, 1.75 ve 2. dereceden türevleri için Varyasyonel iterasyon metodu kullanarak elde ettiğimiz yaklaşık çözümler kıyaslanmıştır. Metod ile elde ettiğimiz yaklaşık çözümler kesin çözümlerle büyük ölçüde benzer sonuçlar vermiştir. Çalışma sonucunda, başlangıç değerlerine sahip lineer olmayan kesirli diferansiyel denklemlerin çözümlerini elde etmek için Varyasyonel iterasyon metodunun uygulanabilirliği gösterilmiştir.*

**Anahtar Kelimeler:** Varyasyonel iterasyon metodu, Riemann-Liouville, Caputo

**Approximate Solutions of Nonlinear Fractional Differential Equations by Variational Iteration Method**

**Eray Yesilyurt<sup>\*</sup>, Fadime Dal<sup>1</sup>**

<sup>1</sup>Ege University, Faculty of Science, Department of Mathematics, 35100, İzmir, Türkiye

<sup>\*</sup>Corresponding author e-mail: 91220001479@ogrenci.ege.edu.tr

***Abstract***

*Nonlinear differential equations serve as crucial mathematical modeling tools in various physical, engineering, and mathematical problems. However, the analytical solutions of these equations are often challenging or even impossible to obtain. Therefore, numerical or approximate solution techniques are used. The Variational Iteration Method (VIM) stands out as a frequently used technique for approximating solutions of nonlinear differential equations. VIM is a method utilized to find approximate solutions of differential equations that are difficult to solve analytically. Its fundamental principle lies in expressing the solution of the equation as a series. This series can be considered as a combination of a fundamental function series and a series of coefficients. In the initial step, determining the fundamental function series is essential. Subsequently, the coefficients in this series are determined to satisfy the given conditions of the equation. This process is iteratively repeated until an approximate solution is obtained. In our study, the Variational Iteration Method has been applied to obtain solutions of nonlinear differential equations with initial conditions. The approximate solutions calculated using the Wolfram Mathematica program are presented with tables and figures. The Variational Iteration Method proves to be an effective technique for approximating solutions of nonlinear differential equations. It can be applied in cases where analytical solutions are not feasible, offering a wide range of applications in various physical, engineering, and mathematical problems*

**Keywords:** Variational Iteration Method, Nonlinear differential equations



**Determining the Best Probability Distribution Models for the Long-term Temperature and Rainfall Data Observed at the Adana Meteorological Station in Türkiye**

**Serin Değerli Şimşek<sup>1\*</sup>, Evren Turhan<sup>1</sup>, Mahmut Çetin<sup>2</sup>**

<sup>1</sup>Adana Alparslan Türkeş Science and Technology University, Faculty of Engineering, Civil Engineering Department, 01250, Adana, Türkiye

<sup>2</sup>Cukurova University, Faculty of Agriculture, Department of Agricultural Structures and Irrigation, 01250, Adana, Türkiye

\*Corresponding author e-mail: sdegerli@atu.edu.tr

***Abstract***

*When designing and managing water resources, it is important to estimate a meteorological variable corresponding to a certain probability value. Thus, water engineering planning studies will greatly benefit from future temperature and rainfall forecasts. The calculations in this study were conducted by analysing the 52-year average monthly rainfall and temperature data (between 1970 and 2021) of the Adana Regional station situated within the Seyhan Basin, Türkiye. The Normal, Log-normal, and Gumbel probability distribution models were used to get the expected values for recurrence periods of 2, 5, 10, 25, 50, 100, 200, 500, and 1000 years. To this end, Kolmogorov-Smirnov goodness-of-fit test was applied to determine the best-fitted probability distribution. Gumbel distribution offered the most accurate predictions for temperature and precipitation values in the current region, according to the goodness-of-fit test results. It can be said that the projected extreme temperature level, which corresponds to the 1000-year return period (T1000), exceeds the T2 values by 3°C. Regarding rainfall values, it can be inferred that the maximum value can be approximately 2.5 times the average rainfall amount. Maximum rainfall and temperature estimates for all seasons were obtained with Log-normal distribution. The predicted temperature values showed minimal variance for all distributions. However, significant disparities were noted in the Normal and Log-normal distribution results for rainfall values. Notably, the goodness-of-fit test results appeared similar in spite of these variations. Furthermore, to improve computation accuracy, data were plotted for both distributions on probability papers. The visual inspection revealed that the temperature and rainfall data fit the Log-normal probability distribution more closely, compared to the Normal distribution. Consequently, the order of preference for the probability distributions utilized in the Adana region can be ranked as Gumbel-Lognormal-Normal.*

**Keywords:** *Probability Distribution Models, Kolmogorov-Smirnov goodness-of-fit test, Rainfall, Temperature, Adana-Türkiye*

**Developing Grade/tonnage Curves and Estimating Confidence Intervals for Long-term Temperature Data Observed in Adana Province, Türkiye**

**Serin Değerli Şimşek<sup>1\*</sup>, Mahmut Çetin<sup>2</sup>, Evren Turhan<sup>1</sup>**

<sup>1</sup> Adana Alparslan Türkeş Science and Technology University, Faculty of Engineering, Civil Engineering Department, 01250, Adana, Türkiye

<sup>2</sup> Cukurova University, Faculty of Agriculture, Department of Agricultural Structures and Irrigation, 01250, Adana, Türkiye

\*Corresponding author e-mail: sdegerli@atu.edu.tr

***Abstract***

*Meteorological data are of great importance in hydrologic desing studies and have been consistently measured for only the past few decades with the advent of automatic meteorological devices. Even though the available data represents only the last century, it is possible to evaluate the behavior of the general population with confidence intervals. In this study, monthly average temperature values measured for the Adana region between 1970 and 2021 have been obtained to evaluate the seasonal changes in temperature data. In turn, sample mean and standard deviation values were estimated for each season, i.e., spring, summer, autumn, and winter. The data's compatibility with the normal distribution was visually examined by using probability paper. Then confidence intervals for the population were predicted for the mean and standard deviation values of each season. In addition, selection curves, i.e., grade/tonnage curves, have been developed to figure out what proportion of the study area is likely to exceed the specified value, i.e., cutoff value, and what is the average value within that proportion. In this context, it can be said that the average temperature values lie around 10°C for winter, 17°C for spring, 27°C for summer, and 21°C for autumn months, with a 90% confidence level. Considering the maximum and minimum temperature values in the data set as the cutoff values for the seasons, it's evident that the average temperature for values surpassing 26°C in summer is expected to be 27.7°C. Similarly, for spring and autumn, the average temperatures for values exceeding 16°C and 20°C in summer are expected to be 17.9°C and 21.5°C, respectively. The study yields valuable insights into average temperature values that have not been previously observed and those anticipated in the future, leveraging 52 years of monthly average temperature data. Given the unlikelihood of observing entire population, conducting analyses on average values within specific intervals, as demonstrated in this study, would be statistically beneficial.*

**Keywords:** Confidence interval, Normal distribution, Grade-tonnage curves, Adana province, Türkiye

**Application of Statistical Techniques for Determination of Relationships Between Water Quality Parameters of Kasap Stream in Lake Van Basin**

**Ayşenur Gümüş<sup>1\*</sup>, Adnan Aldemir<sup>2</sup>**

<sup>1</sup>Van Yüzüncü Yıl University, Faculty of Engineering, Department of Chemical Engineering, 65080, Van, Türkiye

<sup>2</sup>Van Yüzüncü Yıl University, Faculty of Engineering, Department of Industrial Engineering, 65080, Van, Türkiye

\*Corresponding author e-mail: aysenurr.turan@hotmail.com

***Abstract***

*Surface water quality (SWQ) that describes the physical, chemical, and biological transport and degradation processes of pollutants and their impact on aquatic ecosystems can support policy decision-making for environmental management. Lake Van which is the Turkey's largest lake is the system encompasses lakes, ponds, rivers and streams in a closed basin with water from many different sources. The data in this study were used to perform water quality analysis based on the obtained parameters from Kasap Stream. A total of 22 water quality parameters were used to determine water quality at the discharge into Lake Van. Monitoring sampling and analysis of Kasap Stream were carried out by the Regional Directorate of State Hydraulic Works (Turkey). These variables were evaluated with Turkish Surface Water Quality Regulation (TSWQR, 2015). As a result, Kasap Stream has Class I water quality in terms of seasonal conditions and water parameters. Among the parametric analysis methods, trend distribution, normality, correlation, matrix table, regression and normal distribution of the data set were examined and the relationships between parameters were interpreted statistically. According to the results, except of the Na, K, salinity all of the parameters were within the normal range, water quality parameters were high correlated, and matrix relations with regression equations were related to the other parameters. It was evaluated that the TSS, Na, K, Ca, Mg, Cl, SO<sub>4</sub>-2 (R<sup>2</sup>=1.00), and pH (R<sup>2</sup>=0.9595), PO<sub>4</sub>-3(R<sup>2</sup>=0.9927), DO (R<sup>2</sup>=0.9919) are in a high agreement with obtained water quality data.*

**Keywords:** Van Lake basin, Kasap stream, water quality, regression, correlation



**Deney Tasarımı Yaklaşımı ile Tüketicilerin Duyusal Nitelik ve Eğilimlerinin Belirlenmesi**

**Merve Aydoğan<sup>1\*</sup>, Hülya Bayrak<sup>1</sup>**

<sup>1</sup> Gazi Üniversitesi, Fen Bilimleri Enstitüsü, İstatistik Bölümü, Ankara, Türkiye

\*Sorumlu yazar e-mail: merveaydogan19@gmail.com

**Özet**

*Gıda endüstrisindeki önemli gelişmeler sayesinde üreticiler arasında rekabet artmış ve tüketicilere ürün beğendirme, tüketici beğenisini ölçme gibi amaçlar ortaya çıkmıştır. Duyusal analiz gıdaların; farklı özelliklerini dokunma, tatma, koklama, görme ve işitme duyularının tepkilerine cevap veren, analiz eden, test eden ve üzerinde yorum yapabilmeyi sağlayan bir tanımdır. Duyusal analiz çalışmalarında ürünleri karşılaştırmak ve belirleyici olan duyusal faktörleri saptamak için istatistiksel yöntemler kullanılır. Duyusal analizde önemli bir husus olan duyusal yorgunluğun meydana getirdiği güvenilirlik kaybı dengeli tamamlanmamış blok tasarımlar kullanılarak azaltılır. Bu çalışmada dengeli tamamlanmamış blok tasarımlar ve Durbin sıra sayıları testleri tanıtılarak duyusal analizdeki yeri aktarılmıştır. Ayrıca permütasyon testleri hakkında bilgi verilmiştir. Yapılan bir çalışmada farklı kıyma türleri panelistlere tattırılmış ve elde edilen verilere istatistiksel yöntemler uygulanarak kıyma türleri arasındaki farklar tespit edilmiştir.*

**Anahtar Kelimeler:** *Duyusal Analiz, Dengeli Tamamlanmamış Blok Tasarımlar, Durbin Sıra Sayıları Testi, Permütasyon Testleri*

## Elektrikli Araçlarda Kullanılan Fren Sistemi Parçalarının İstatiksel Proses Kontrol ve 6 Sigma Uygulamaları

**Orkun Tosun<sup>1\*</sup>, Anıl Akdoğan<sup>2</sup>**

<sup>1</sup>Yıldız Teknik Üniversitesi, Fen Bilimleri Enstitüsü, Makine Mühendisliği Anabilim Dalı, 34349, İstanbul, Türkiye

<sup>2</sup>Yıldız Teknik Üniversitesi, Makine Fakültesi, 34349, İstanbul, Türkiye

\*Sorumlu yazar e-mail: orkuntosun1@gmail.com

### Özet

Sınırların ortadan kalktığı küreselleşen dünyada, pazardaki birçok yerli ve yabancı rakip arasında yer alan şirketlerin başarısı, müşterilerin istek ve ihtiyaçlarını doğru anlayıp bunlara hızlı cevap vermeleri ile mümkündür. Rekabet avantajı elde etmek için şirketlerin müşterilerine kaliteli ürünler sunması gerekmektedir. Ürünün kaliteli olması yeterli değil, mümkün olan en düşük maliyetle de üretilmesi gerekmektedir. Firmalar mümkün olan en düşük hata oranıyla üretim yaparak maliyetlerini düşürebilirler. Altı Sigma metodolojisi süreçte gerekli iyileştirmeleri yaparak, milyonda 3,4 hata ile mükemmelliği hedefleyen, müşteri ihtiyaçlarını belirlemeye önem veren bir yöntemdir. Bu çalışmamızda, elektrikli araçlarda kullanılan fren sistemi parçalarının üretimi sonucu karşılaşılan bir müşteri şikayetinin; altı sigma metodolojisi kullanılarak, istatiksel proses kontrol ve kalite iyileştirme uygulaması ele alınmaktadır.

**Anahtar Kelimeler:** Altı sigma metodolojisi, İstatiksel proses kontrol, Kalite iyileştirme, Elektrikli Araçlar, Fren Sistemi İmalatı

## Modeling Life Satisfaction Based on Subgroups in Panel Data

**Saban Kızılarşlan<sup>1\*</sup>, Ceren Camkıran<sup>2</sup>**

<sup>1</sup>Van Yüzüncü Yıl University, Faculty of Economics and Administrative Sciences,  
Department of Econometrics, 65080, Van, Türkiye

<sup>2</sup>Marmara University, Faculty of Economics, Department of Econometrics, 34722, Istanbul, Türkiye

\*Corresponding author e-mail: sabankizilarşlan@yyu.edu.tr

### **Abstract**

*Life satisfaction is directly influenced by the income levels of individuals or, at the macro level, by the economic growth of nations. It is well-established that income level has an augmentative effect on life satisfaction. However, empirical studies indicate that this augmentative effect is not continuous. The Easterlin Paradox posits that the relationship between life satisfaction and income follows a logarithmic function, suggesting that the augmentative effect of income on life satisfaction is stabled at higher income levels. Particularly in macro-level analyses utilizing panel data, the heterogeneous characteristics of countries complicate the deduction of common interpretations. In this study, a clustering-based modeling approach was utilized to overcome the challenges posed by heterogeneity in panel data. The relationship between life satisfaction and economic growth was examined using panel data from 74 countries for the years 2010 to 2022. Additionally, socioeconomic factors such as inflation, unemployment, and urbanization rate were included as control variables in the model. The countries in dataset were stratified into homogeneous subgroups within which separate models were estimated, thereby revealing heterogeneous parameters between clusters. Upon analysis, it was determined that the countries were divided into two clusters, and the effects of variables significantly differed between them. Accordingly, predicted values of life satisfaction have increasing trend in first cluster while decreasing trend in the other. To explore the source of these differences, the clustering process was reconducted focusing on economic growth and inflation, and consistent results were obtained. This circumstance revealed that the divergent cluster outcomes for life satisfaction essentially stem from the differences in economic growth rates and inflation levels of the countries.*

**Keywords:** Panel clustering, Life satisfaction, Economic growth



**Evaluation of Financial Performance of Businesses in BIST Information Technologies Index with MOORA-Ratio Methods**

**Almina Çam<sup>1\*</sup>, Münevver Turanlı<sup>2</sup>**

<sup>1</sup>Istanbul Commerce University, Faculty of Humanities and Social Sciences, Statistics, 34445, Istanbul, Türkiye

<sup>2</sup>Istanbul Commerce University, Faculty of Humanities and Social Sciences, Statistics, 34445, Istanbul, Türkiye

\*Corresponding author e-mail: [almina.cam@istanbulticaret.edu.tr](mailto:almina.cam@istanbulticaret.edu.tr)

***Abstract***

*Informatics is a field of study that covers a wide range of topics, including information and communication technologies. The term "information technology sector" is used to describe a sector that deals with the development, use, marketing, and management of information technology (IT). The BIST IT Index is an index that measures the performance of companies operating in the IT sector on the Borsa Istanbul. The overall performance of the IT sector in Turkey and the movements of stocks provide information to investors in this sector with the BIST IT Index. In this study, the MOORA-Ratio method was employed to assess the financial performance of the companies included in the BIST IT Index. It is concluded that the most optimal enterprises are LINK, MIATK, and SMART, respectively.*

**Keywords:** *Financial Performance, Multicriteria Decision, MOORA-Ratio Methods, BIST Information Technologies Index*

## Hisse Senedini İstatistiksel Yöntemlerle Tahmin Etme

**Arda Osmanliođlu<sup>1\*</sup>, Orhan Yavuz Seçkin<sup>1</sup>, Batuhan Açıkğöz<sup>1</sup>, Ceyhun Kopuz<sup>1</sup>**

<sup>1</sup>Marmara Üniversitesi, İstanbul, Türkiye

\*Sorumlu yazar e-mail: ardaosmanlioglu@gmail.com

### Özet

*Hisse senetlerinin detaylı bir şekilde incelenmesi ve kurulan finansal tahmin modelleri ile (Arch, Garch, Var, dinamik regresyon, Arima...vb.) hisse senedinin forecast fiyat tahmini yapılması, hisse senedine dair en iyi tepki veren modellerin seçilmesi ve tahmin oranlarının doğruluđuna ait bir çalışma olacaktır. Hisse senedi alımları için finansal serilerinin kullanımına dikkat çekilecektir. Bu çalışmada modeller için R studio ve Python kullanılırken; Veri görselleştirme için Power bi ve Tableau kullanılacaktır. Projemiz dikkat çekici ve günlük hayatta kullanılabilir etkili bir projedir.*

**Anahtar Kelimeler:** Zaman serileri modelleri, finansal modeller



## Weather Forecasting with Machine Learning

**Burcu İnan<sup>1\*</sup>, Asude Begüm Tiryaki<sup>1</sup>, Buse Karakaya<sup>1</sup>, Ercan Öztemel<sup>1</sup>**

<sup>1</sup>Marmara University, Faculty of Engineering, Industrial Eng., 34854, Istanbul, Türkiye

\*Corresponding author e-mail: burcuiran@gmail.com

### *Abstract*

*Weather conditions are phenomena that affect every aspect of life. Especially with the impact of global warming, sudden and abnormal weather events threaten sustainable living. Being able to accurately predict the weather in advance is important for taking precautions against potential adversities. Particularly in the field of agriculture, weather conditions can vary significantly even within a distance of 1 km. However, it is not feasible with today's technology to produce prediction data for every point on the Earth's surface. In this study, data provided by the ECMWF model with a grid resolution of 9x9 km<sup>2</sup> is used to make temperature predictions for intermediate points using machine learning, aiming to increase resolution. This way, temperature differences in narrow areas can be detected. Machine learning models including Random Forest, Support Vector Regression, and Multilayer Perceptron learner models were used for this prediction. As a result, all three models of Random Forest, Support Vector Regression, and Multilayer Perceptron made predictions within a tolerance range of +2 degrees. Hybrid models were created to further improve the prediction by averaging and weighted averaging to reduce the error rate.*

**Keywords:** *Machine Learning, Multilayer Perceptron, Random Forest Regression, Support Vector Regression, Weather Forecasting,*



## Makine Öğrenme Yöntemleri ile Telekomünikasyon Müşteri Kaybı Analizi

Elif Arı<sup>1\*</sup>, Alanur Mercan<sup>1</sup>, Ceyda Salihoğlu<sup>1</sup>

<sup>1</sup>Marmara Üniversitesi, Fen Edebiyat Fakültesi, İstatistik Bölümü, 34180, İstanbul, Türkiye

\*Sorumlu yazar e-mail: elif\_ari01@hotmail.com

### Özet

Müşteri bilgilerini inceleyerek ayrılma olasılığı olan çifte ait profilleri, terk etme olasılığı yüksek müşterilerin önceden tahmin etme müşteri kaybı analizi olarak adlandırılmaktadır. Müşteri kaybı tahmini, hizmetlerin iptal edilmesi muhtemel abonelerin açıklanmasında önemli rol oynar. Bu planlamacı yaklaşımı yalnızca müşteri hacmini artırmakla kalırken, aynı zamanda müşteri kaybının kaybının geliri de güvencesi”nde yer alıyor. Bununla birlikte, risk dünyasındaki belirli beklentileri ve endişelerini anlayıp bu durumu ele alarak bunu öngörmelerine ve hafifletmelerine de olanak tanımaktadır. Hızla büyüyen ve rekabet ortamının her geçen gün artması, kalıpların farklılaştığı operatör değiştirdiği ve bu sayede her yerde dolar zararına yol açan telekomünikasyon sektöründe, müşteri kaybı analizi daha da önem kazanmaktadır. Bu bağlamda kayıp analizinin amacı sadece müşteri kaybetmeye bakmanın ötesindedir. Sayılarınızın ardındaki temel kökenlerdeki ayrılıklarla ayrıntıları. Sonuçta başarılı kayıp analizi, işletme müşterinizin kaybının başlaması için gereken değer olan değerli bilgilerin boyutunun kaybolması. Bu etkili da telekomünikasyon sektöründe müşteri kaybı tahmin etmek için çeşitli sınıflama yöntemleri yoluyla bir analizin gerçekleştirilmesi planlanmıştır. Analiz, 7043 müşteriden oluşan ve onun müşterisi için 21 adet özellik ile yönetimini terk edip bırakmamasına süt sınıfı bilgisi içeren bir veri seti üzerinde gerçekleştirilmiştir.

**Anahtar Kelimeler:** Makine Öğrenmesi, Churn Analizi, Telekomünikasyon

**Locally Sparse and Robust Partial Least Squares in Scalar-on-Function Regression**

**Sude Gurer<sup>1\*</sup>, Han Lin Shang<sup>2</sup>, Abhijit Mandal<sup>3</sup>, Ufuk Beyaztaş<sup>1</sup>**

<sup>1</sup>Marmara Üniversitesi

<sup>2</sup>Macquarie University

<sup>3</sup>University of Texas at El Paso

\*Corresponding author e-mail: sudegurer4@gmail.com

***Abstract***

*We present a novel approach for estimating the scalar-on-function regression model, leveraging a functional partial least squares methodology. Our proposed method involves computing the functional partial least squares components through sparse partial robust  $M$  regression, facilitating robust and locally sparse estimations of the regression coefficient function. This strategy delivers a robust decomposition for the functional predictor and regression coefficient functions. After the decomposition, model parameters are estimated using a weighted loss function, incorporating robustness through iterative reweighting of the partial least squares components. The robust decomposition feature of our proposed method enables the robust estimation of model parameters in the scalar-on-function regression model, ensuring reliable predictions in the presence of outliers and leverage points. Moreover, it accurately identifies zero and nonzero sub-regions where the slope function is estimated, even in the presence of outliers and leverage points. We assess our proposed method's estimation and predictive performance through a series of Monte Carlo experiments and an empirical dataset- the oriented strand board furnish data. Comparative evaluations with existing methods demonstrate the favorable performance of our proposed method. Notably, our robust procedure exhibits superior performance in the presence of outliers while maintaining competitiveness in their absence. Our method has been implemented in the `robfppls` package in R.*

**Keywords:** *Dimension Reduction, Functional Linear Regression, Robustness, Sparse Estimation*

## Python ile Web Sitelerinden Veri Çekme

Yasemin Arslan<sup>1\*</sup>

<sup>1</sup>Marmara University, Faculty of Science, Statistics, 34707, Istanbul, Türkiye

\*Sorumlu yazar e-mail: yaseminarslan20@marun.edu.tr

### Özet

*Süt ürünlerinin satıldığı bir online alışveriş sitesindeki süt ürünlerinin bilgilerini fiyatlarını düzenli aralıklarla çekmek daha sonrasında piyasa analizi ,pazar araştırması, rekabet analizi , gelecek ayların fiyat tahmini gibi analizlerde güncel verileri kullanmak. Bu proje için Python programı kullanıyorum. Yazdığım bu kod sayesinde websitesinin URL'si ve belli parametreler girilerek her tür websitede ki verilerin çekilmesini sağlamak mümkündür. Burada analiz yapabilmek için veriyi kendimiz elde ediyoruz bu yöntemle.*

**Anahtar Kelimeler:** Web Kazıma, Otomatik Veri Çekme, Python, Selenium Paketi, Güncel Veri, Sistematik Veri Çekme





Fuzzy Esnek Küme Yöntemi Kullanılarak Tıbbi Karar Verme

Zeynep Keskin<sup>1\*</sup>, Rahmet Savaş<sup>1</sup>

<sup>1</sup>İstanbul Medeniyet Üniversitesi, Mühendislik ve Doğa Bilimleri Fakültesi, Matematik Bölümü,  
34000, İstanbul, Türkiye

\*Sorumlu yazar e-mail: zeynepkeskin867@gmail.com

**Özet**

*Bu çalışmada, tiroit kanseri şüphesi olan hastalar için belirlenen öznel değerlerine göre 3 farklı uzman doktor görüşünün Bulanık Esnek Küme (FSS) yöntemi ile optimize edilerek belirlenen hastalığa sahip olma riski en yüksek olan hasta veya hastalar hakkında nihai optimal karar verilmesi gösterilecektir. Bu yöntem ile hem doktorlar hem de hastalar için zaman ve enerji tasarrufu sağlamak hedeflenmektedir. Tiroit kanseri teşhisinde kullanılan kan ve ultrasonografi değerleri Bulanık Küme yönteminde (FSS) birer parametre olarak alınarak, karar vermede Roy-Maji yaklaşımı uygulanır. Bunun sonucunda tiroit kanserine yakalanma riski en yüksek olan hasta veya hastalar hakkında nihai optimal karar verilmiş olur.*

**Anahtar Kelimeler:** Bulanık Esnek Küme, Optimal karar verme, Bulanık Küme, Tiroit kanseri

**Dermai: Her Zaman Erişilebilir Dermatolojik Çözümler**

**Umay Yentür<sup>1\*</sup>, Ekin Beykın<sup>1</sup>**

<sup>1</sup> Marmara Üniversitesi

\*Sorumlu yazar e-mail: umay.yentur@gmail.com

**Özet**

*DERMAI, günün her saatinde ve hızlıca erişilebilen bir çözüm sunarak, cilt sorunları ve dermatolojik endişeleri olan kişilerin yaşamlarını kolaylaştırır. Ayrıca, sağlık hizmetlerine daha geniş bir erişim sağlar, böylece insanlar cilt sağlıkları için gereken adımları hızla atabilirler. Yeni nesil doktorunuzla tanışın: Kullanıcı dostu arayüzüyle evinizdeki doktorunuz, fotoğrafınızı çekin ve hızlı teşhis alın, 7/24 hizmetten yararlanın, teşhis sonrası doktorlarımızla görüşme talep edebilirsiniz. Amacımız hızlı ve etkili teşhis sağlamak, ulaşılabilirlik artırmak ve acil durumlar için hızlı çözümler sunmaktır. Uygulama nasıl kullanılır? Fotoğrafınızı çekin veya galeriden seçin, DERMAI tarafından teşhis konulsun, sonrasında doktorunuza soru sorun veya randevu alın. Modelimizin çalışma şekli, convolutional layer ile başlar, pooling layer ile devam eder, flattening layer ile veriler düzenlenir ve fully-connected layer ile öğrenme işlemi tamamlanır. Gelecek planlarımız arasında hastalık çeşitliliğini artırmak ve bölgesel analizle daha iyi sonuçlar elde etmek bulunmaktadır.*

**Anahtar Kelimeler:** Dermatoloji, Teşhis, Görüntü İşleme, Yapay Zekâ, Derin Öğrenme

## Robust Function-on-Function Regression: A Penalized Tau-Based Estimation Approach

Ufuk Beyaztaş<sup>1\*</sup>

<sup>1</sup> Marmara University, İstanbul, Türkiye

\*Corresponding author e-mail: ufuk.beyaztas@marmara.edu.tr

### *Abstract*

*This study introduces a novel penalized estimation method tailored for function-on-function regression models, combining the robustness of the Tau estimator with penalization techniques to enhance resistance to outliers. Function-on-function regression is essential for modeling intricate relationships between functional predictors and response variables across diverse fields. However, traditional methods often struggle with outliers, leading to biased estimates and diminished predictive performance. Our proposed approach addresses this challenge by integrating robust Tau estimation with penalization, promoting both robustness and parsimony in parameter estimation. Theoretical foundations of the penalized Tau estimator within function-on-function regression are discussed, along with empirical validations through simulation studies and empirical data applications. By incorporating penalization, our method not only ensures robust estimation of regression parameters but also promotes model simplicity, offering enhanced interpretability and generalization capabilities in functional data analysis.*

**Keywords:** Functional Data, Penalization, Regression Tau Estimator



**Moment-based Approximations for Stationary Characteristics of a Stochastic Control Model of Type (s,s) with Asymmetric Triangular Distributed Interference of Chance**

**Tahir Khanıyev<sup>1,2\*</sup>, Feyrouz Baghezza<sup>3</sup>, Aslı Bektaş Kamışık<sup>4</sup>, Tulay Yazır<sup>3</sup>**

<sup>1</sup>TOBB University of Economics and Technology, Faculty of Engineering, Department of Industrial Engineering, 06560, Ankara, Türkiye

<sup>2</sup>Azerbaijan State University of Economics, The Center of Digital Economics, AZ1001, Baku, Azerbaijan

<sup>3</sup>Karadeniz Technical University, Faculty of Science, Department of Mathematics, 61080, Trabzon, Türkiye

<sup>4</sup>Recep Tayyip Erdoğan University, Faculty of Arts and Sciences, Department of Mathematics, 53020, Rize, Türkiye

\*Corresponding author e-mail: tahirkhaniyev@etu.edu.tr

**Abstract**

*In this study, a semi-Markovian inventory model of type (s,S) is expressed by a modification of a renewal-reward process  $X(t)$  with asymmetric triangular distributed interference of chance. Approximation formulas are presented for stationary characteristics of the process based on the first three moments of demand random variables. Various asymptotic expansions for different modifications of this model can be found in the literature. All of these studies assume that the distribution function of the demand random variables is known. They require determining the asymptotic expansion of the renewal function generated by them. However, obtaining a renewal function for many distribution families may be challenging or the renewal function's mathematical structure difficult to apply. Another issue with utilizing the asymptotic expansion method is that the remaining terms after the first two or three terms are usually represented by small oh (o) or big oh (O) notations. In this case, it is not possible to precisely observe how the remaining terms converge to zero. However, understanding the manner in which the remaining terms converge to zero is crucial for the application. For this reason, our aim was to obtain simple and compact approximations for stationary characteristics of a stochastic control model of type (s,S) with asymmetric triangular distributed interference of chance. To achieve this goal approximation formula for the renewal function proposed by Kambo et. al. (2012) is used. We have derived approximate formulas for the ergodic distribution and for  $n^{\text{th}}$  order moments of the ergodic distribution of the process  $X(t)$  following Kambo's approach. Reference: Kambo, N.S., Rangan, A. & Hadji, E.M. (2012). Moment based approximation to the renewal function. Communication in Statistics-Theory and Methods, 41(5), 851-868.*

**Keywords:** Inventory model of type (s,S), Moment-based approximations, Asymmetric triangular distribution, Ergodic distribution, Discrete interference of chance.

**Lindley Nadarajah-haghighi Distribution**

**Selen Çakmakyapan<sup>1\*</sup>**

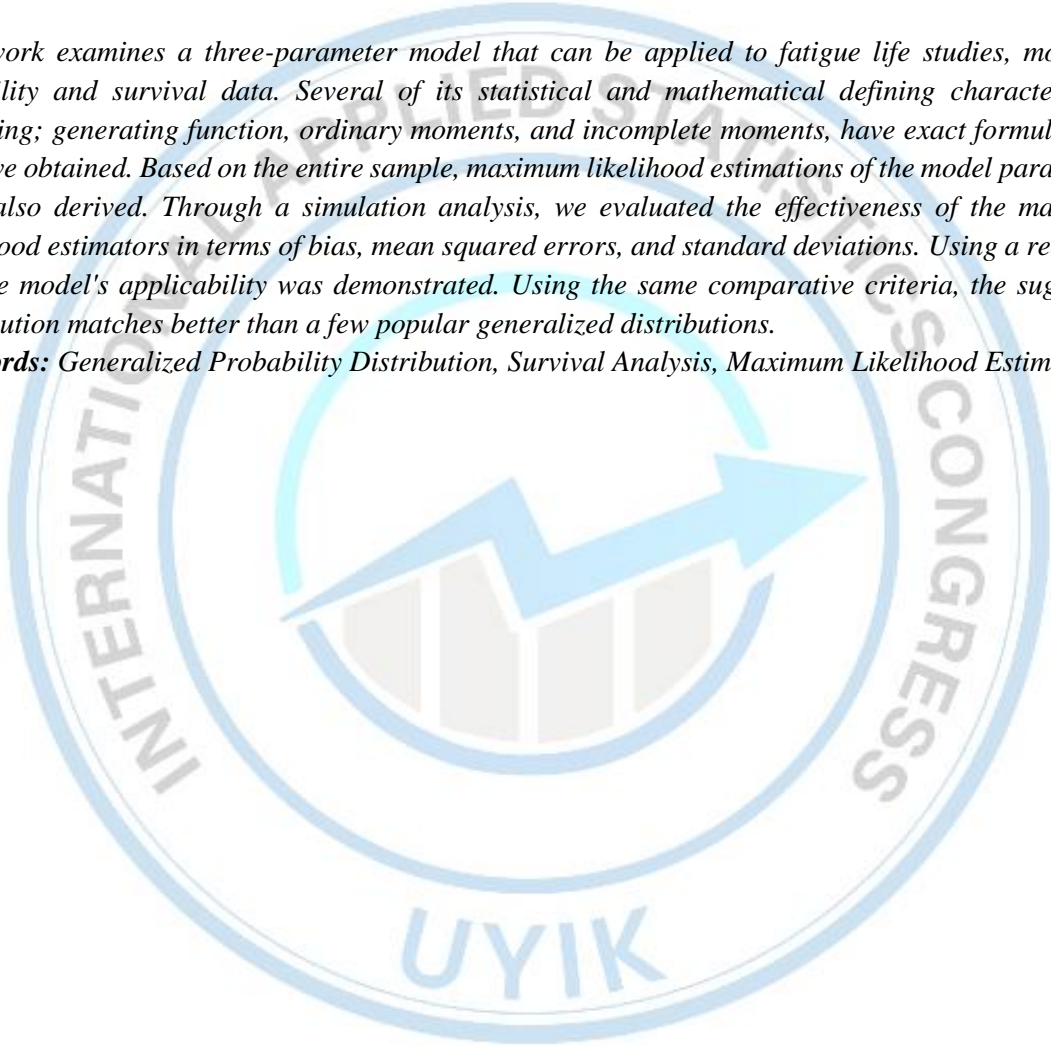
<sup>1</sup>Istanbul Medeniyet University, Faculty of Engineering and Natural Sciences, Department of Statistics,  
34700, İstanbul, Türkiye

\*Corresponding author e-mail: selen.cakmakyapan@medeniyet.edu.tr

***Abstract***

*This work examines a three-parameter model that can be applied to fatigue life studies, modeling reliability and survival data. Several of its statistical and mathematical defining characteristics, including; generating function, ordinary moments, and incomplete moments, have exact formulas that we have obtained. Based on the entire sample, maximum likelihood estimations of the model parameters were also derived. Through a simulation analysis, we evaluated the effectiveness of the maximum likelihood estimators in terms of bias, mean squared errors, and standard deviations. Using a real data set, the model's applicability was demonstrated. Using the same comparative criteria, the suggested distribution matches better than a few popular generalized distributions.*

**Keywords:** *Generalized Probability Distribution, Survival Analysis, Maximum Likelihood Estimation*



**Estimation for the Multicomponent Stress-Strength Reliability under Continuous Bernoulli Distribution**

**Sümevra Sert<sup>1\*</sup>, Coşkun Kuş<sup>1</sup>**

<sup>1</sup>Selçuk University, Faculty of Science, Department of Statistics, 42250, Konya, Türkiye

\*Corresponding author e-mail: sumeyra.sert@selcuk.edu.tr

***Abstract***

*The topic of multicomponent stress-strength reliability has recently become a focal point of interest. Generally, stress and strength distributions are selected from the  $(0, \infty)$  range. In this research, we investigate multicomponent stress-strength reliability within the  $(0,1)$  domain utilizing the continuous Bernoulli distribution. This study assesses confidence intervals using both maximum likelihood estimation (MLE) and bootstrap techniques via simulations, emphasizing coverage probability and mean length. Furthermore, a numerical example is included for explanatory purposes. **Keywords:** Bootstrap, Continuous Bernoulli distribution, Confidence interval, Stress-strength reliability.*





**Bibliometric Analysis of Published Studies on Poisson Processes**

**Senol Celik**<sup>1\*</sup>

<sup>1</sup>Bingöl University, Faculty of Agriculture, Department of Animal Science, Bingöl, Türkiye

\*Corresponding author e-mail: senolcelik@bingol.edu.tr

***Abstract***

*In this study, 814 publications produced by Poisson Counting processes between 1990-2024 were accessed from the Web of Science database and bibliometric analyses were performed with the data obtained. In the obtained data set, 79 of the 2405 authors in 324 journals contributed as a single researcher. The publication status of the journals in the data set was evaluated. In addition, the effect of bibliographies was analyzed. Looking at the distribution of publications by years, the highest number of articles was reached in 2022, 2017 and 2021, respectively. In these years, 46, 41 and 41 articles were published respectively. When keywords were analyzed, "humans", "animals", "poisson distribution", "computer simulation", "models statistical", "models neurological", "stochastic processes", "neurons", "action potentials", and "algorithms" were the most frequently used concepts. Physical Review. E, Statistical, Nonlinear, and Soft Matter Physics, Bimetrics, and Statistics in Medicine were found to be among the most influential journals in the field. The authors who produced the most articles were Zhang X, Li Y, Mino H and Zhang Y, respectively. In addition, Departamento De Medicina Veterinária Preventiva Brazil, China The First Affiliated Hospital of Xiamen University and University Of California School Of Medicine, USA were found to be at the forefront of the studies on this subject. With this study, it is aimed to provide a guide for researchers by describing the articles published on Poisson Processes from different perspectives.*

**Keywords:** *Bibliometrics, Poisson processes, collaboration.*

## Climate Change Performance: Analysis of Factors Affecting CO<sub>2</sub> Emissions

Gülçin Yangın<sup>1\*</sup>, Serpil Kılıç Depren<sup>1</sup>

<sup>1</sup>Yıldız Technical University, Department of Statistics, 34220, İstanbul, Türkiye

\*Corresponding author e-mail: gulcn.yangin@gmail.com

### *Abstract*

*Carbon dioxide (CO<sub>2</sub>) emissions are the cause of global warming and climate change and are the most important problem of our time. A scoring system has been developed to reduce the negative effects of climate change, raise awareness in this regard, and improve the transparency of climate policies. This system, which was designed by the German environmental and development organization Germanwatch e.V., is called the Climate Change Performance Index (CCPI). Annually, the report is presented to the United Nations (UN) Climate Change Conference, having been created using this scoring system that takes into account various criteria. Within the scope of this study, data from 62 countries included in the CCPI report is gathered. Hence, the study comprehensively examines by using annual data from 2002 to 2020, using machine learning algorithms to investigate the effect of 10 explanatory variables on CO<sub>2</sub> emissions. The findings reveal that (i) the most accurate prediction algorithm is XGBOOST by performance criteria; (ii) renewable energy consumption emerges as the most impactful factor in the model, with migration, trade, Gross Domestic Product (GDP), and health expenditures, respectively; (iii) an increase in renewable energy consumption correlates with a reduction in CO<sub>2</sub> emissions. Conversely, higher migration levels are associated with an increase in CO<sub>2</sub> emissions. To effectively reduce CO<sub>2</sub> emissions, it is crucial to emphasize the adoption of renewable energy sources and manage population growth.*

**Keywords:** CO<sub>2</sub> Emissions, Machine Learning, Climate Change, Renewable Energy, Neural Network.

## The Emerging Trends of Statistical Analysis for Language and Literature Research: A Developing Country Perspective

Saima Iram<sup>1\*</sup>, Almas Khanum<sup>1</sup>, Maria Ameen<sup>1</sup>, Hammad Niazi<sup>1</sup>

<sup>1</sup>Government College University, Department of Urdu, Lahore, Pakistan

\*Corresponding author e-mail: drsaimairam@gmail.com

### Abstract

*The science of gathering, evaluating, summarizing, presenting, and understanding data for presentation and interpretation is known as statistics. Its a valuable tool for qualitative or quantitative data analysis in the domain of language and literature research. Therefore, we may think of statistical analysis in language and literature research as a methodical, tested way to examine numerical data in order to optimize our comprehension of what the numbers are trying to tell us. Language and literature scholars can find patterns, correlations, and insights in textual data that may not be readily visible through qualitative analysis alone by using statistical tools. The main goal of application of statistical examination in language and literature is to offer factual, objective data that either validates or invalidates ideas, interpretations, or hypotheses on language and literary phenomena. Researchers can use statistical analysis to provide a systematic framework for quantitative examination of language and literature, from analyzing word frequency in a novel to exploring the connection between literary themes and linguistic traits. This might involve investigating literary components like story structure, characterisation, and symbolism in addition to examining language characteristics like syntax, semantics, and speech patterns. Researchers may evaluate and quantify a variety of features of language and literature using statistical approaches, which makes their research more thorough and repeatable. In statistical study of language and literature, a number of fundamental methods are frequently used, including text mining and natural language processing (NLP) approaches, correlation analysis, descriptive and inferential statistics, stylistic analysis, and more. The objectives of this research paper are to provide a clear idea about how relevant are statistical analysis in language studies and literature. Statistics can aid in decision-making and provide context for results, but they can also be used to make accurate predictions about the future that would likely occur if decisions were carried out. However, these predictions would be useless without the use of statistical tools. This study will help to understand basic research concepts applied in the field of language and literature. Moreover, this study aims to provide an introduction to statistical methods used in the field of language and literature with reference to Pakistan. Further, this research study aimed to map out some of the linguistic and literary research questions which these methods can be applied to. All stakeholders involved in the language and literary fields may access and understand the clear information produced by statistics. This research will demonstrate how statistical methods may be quite helpful while investigating authorship attribution and textual authenticity, exploring patterns of language variation and change over time or across different genres, examining the impact of cultural, social, and historical factors on linguistic and literary phenomena, By employing statistical analysis, researchers in language and literature can enhance their understanding of textual data, generate new research questions, and contribute to interdisciplinary scholarship that bridges the gap between quantitative analysis and qualitative interpretation.*

**Keywords:** Statistical methods, Statistical analysis, Urdu literature, Pakistan



**Evaluation of Family and Romantic Relationships of Young Adults with Boarding School Experience within the Framework of Attachment Theory: A Phenomenological Study**

**Merve Nur Güngör<sup>1\*</sup>, Makbule Kalı Soyer<sup>1</sup>**

<sup>1</sup>Marmara University, İstanbul, Türkiye

\*Corresponding author e-mail: merve.ngungor@gmail.com

**Abstract**

*This study aims to evaluate the family and romantic relationships of young adults with boarding school experience within the framework of attachment theory. Boarding schools, where thousands of students continue their education every year, are opportunities for families and students considering transportation, economic opportunities and quality of education. However, spending the adolescence period, which is one of the critical periods of development, separated from their families and under the authority of the institution may leave some negative effects on students. Many researchers working with students who experienced boarding at an early age have revealed these traumatic effects and the sum of these effects has been named boarding school syndrome. This study will focus on the effects of boarding school experience on individuals and its effects on their family and romantic relationships. The study was designed with a qualitative research method that allows in-depth examination of the perceptions and experiences of the participants. The phenomenological approach, which helps to discover and make sense of phenomena, was preferred as the research approach. The study was conducted with 15 young adults between the ages of 23 and 38 who had boarding school experience and had attended at least one of the secondary or middle school levels. The data were collected using a Semi-Structured Interview Technique, which provides flexibility to the researcher, and a Semi-Structured Interview Form. In the analysis of the data, the content analysis method, which enables the explanation and interpretation of the collected data, was preferred and MAXQDA-24, a qualitative data analysis program, was used. The codes and categories created were organized in diagrams with the application and themes were reached from there. Accordingly, a total of 13 different themes were identified in the study. Seven different themes were reached regarding how young adults with boarding school experience perceive boarding. These themes are "Boarding as a Career Step", "Boarding as a Teacher of Life", "Growing up in a Boarding School", "Boarding as an Escape from the Family", "The Biggest Gain of Boarding is Friendships", "The Cruel Face of Boarding", "Boarding as a Risk". Regarding the effects of boarding school on the participants, 2 different themes, namely "Me After Boarding School" and "Traumatic Experience", were reached. From the data obtained from the participants, the themes of "Loss of Safe Base" and "Changing Family Relations" were reached regarding the reflection of the boarding school experience on family relationships. Regarding the reflection of this experience on romantic relationships, the themes of "Attachment Patterns in Romantic Relationships" and "Meaning Attributed to Relationship" were reached. The themes were discussed within the framework of the relevant literature.*

**Keywords:** Boarding, Boarding School Experience, Attachment Theory

**The Mediating Role of Gender and Income in The Effect of Generation Z Financial Behaviors on Conscious Consumption**

**Emine Nihan Cici Karaboğa<sup>1</sup>, Gamze Sekeroğlu<sup>2\*</sup>, Esra Kızıloğlu<sup>2</sup>**

<sup>1</sup> Necmettin Erbakan University, Faculty of Applied Science, Department of Manament Information Systems, 42080, Konya, Türkiye

<sup>2</sup> Selcuk University, Faculty of Economics and Administrative Sciences, Department of International Trade and Finance, 42130, Konya, Türkiye

\*Corresponding author e-mail: enihancici@erbakan.edu.tr

**Abstract**

*Consumption is increasing day by day due to reasons such as the acceleration of technological transformation and the increase in human population. Understanding the reasons for this increase and producing solutions has become the main subject of consumer-related studies as the world's scarce resource levels have fallen to dangerous levels. In this context, the main purpose of this research is to examine the effect of financial literacy of Generation Z on simple consumption and rational consumption, which are the dimensions of conscious consumption. While examining this effect, it is also aimed to see the effect of gender and income levels as mediating variables. Survey method, which is a quantitative research method, was preferred for this research. The survey questionnaire consists of financial literacy, conscious consumption scale and demographic questions. The target group was determined with the judgmental sampling method, taking care to have Generation Z participants within the universe predicted for the study. The data obtained through this survey were analyzed and interpreted by applying the structural equation model with the R programming language. Since the data collection process of the research is ongoing, a clear projection regarding the results could not be formed.*

**Keywords:** Financial literacy, conscious consumption, r programming language

**Evcil Hayvanlara Dönük Pazarlama Literatürünün Gelişiminin Bibliyometrik Analiz ile İncelenmesi**

**İpek Deveci Kocakoç<sup>1</sup>, Pınar Özkan<sup>2</sup>**

<sup>1</sup> Dokuz Eylül Üniversitesi, İ.İ.B.F., Ekonometri Bölümü, 35140, İzmir, Türkiye

<sup>2</sup> Dokuz Eylül Üniversitesi, İ.İ.B.F., İşletme Bölümü, 35140, İzmir, Türkiye

\*Sorumlu yazar e-mail: ipek.deveci@deu.edu.tr

**Özet**

*Evcil hayvan sahipliği son yıllarda özellikle pandemiyle birlikte çok yaygınlaşmıştır. Her geçen gün sayısı artan bu kitlenin ihtiyaçları beraberinde yeni bir pazar yaratmıştır. Bu pazarın ihtiyaçlarını anlamak ve yönetmek çeşitli zorluklar içermektedir. Bu çalışmanın temel amacı evcil hayvanlara dönük pazarlama araştırmaları alanının bibliyometrik analizini yapmaktır. Bu amaçla Vos veri tabanında yer alan makaleler "pet consumption" ve "pet market" ile ilgili çeşitli anahtar kelimeler için taratılmış ve 3488 adet makale üzerinden veri seti oluşturulmuştur. Bu çalışmanın alandaki çalışmaların evrimini ortaya koyarak, önemli dergileri, makaleleri ve yazarları belirlemesi, ana araştırma akışlarını inceleyerek gelecekteki araştırmalar için fırsatları ve alanları ortaya koyması beklenmektedir. Çalışmada temel bibliyografik analizler için Vosviewer paket programının yanı sıra, konu dağılımını ve eğilimlerini belirlemek için Latent Dirichlet Allocation (LDA) ve trend analizi için Python dili ile yazılmış kodlar kullanılmıştır. LDA analizi ile evcil hayvan pazarlaması alanındaki metinlerdeki gizli konuları keşfetmek ve bu konuların içeriğini anlamak amaçlanmıştır. Analiz sonucunda "Dijital Hayvan Pazarlaması", "Hayvan Sağlığı ve Beslenmesi", "Ürün Geliştirme ve İnovasyon", "Tüketici Davranışları ve Marka Analizi" olmak üzere dört temel konu başlığı belirlenmiştir.*

**Anahtar Kelimeler:** Evcil Hayvan, Pazarlama, Tüketim, Bibliyometrik analiz, LDA



## İklim Değişikliğinde Gençlerin Farkındalığı ve Yeşil Mutabakat Eylem Planı Üzerine Bir Nicel Araştırma

**Özgür Danışman<sup>1\*</sup>, Aslıhan Kabasakal<sup>2</sup>, Ahmet Cem İşeri<sup>2</sup>**

<sup>1</sup>Dokuz Eylül Üniversitesi, Fen Fakültesi, İstatistik Bölümü, 35390, İzmir, Türkiye

<sup>2</sup>Dokuz Eylül Üniversitesi, Edebiyat Fakültesi, Sosyoloji Bölümü, 35390, İzmir, Türkiye

\*Sorumlu yazar e-mail: ozgur.danisman@deu.edu.tr

### Özet

İklim değişikliği ve beraberinde getirdiği sorunlar küresel ölçekte uyarı veren konuların başında gelmektedir. Yeşil Mutabakat Eylem Planı ülkelerin gündemlerinde olan, tüm çevresel unsurları dikkate alan ve iklim değişikliği konusuna son derece kapsayıcı şekilde yaklaşan bir belge olarak karşımıza çıkmaktadır. Yeşil mutabakat Eylem Planı'nda da karşımıza çıkan iklim değişikliği sorunlarıyla mücadele adımlarının ancak geniş tabanlı bir farkındalık oluşturulmasıyla gerçekleşebileceği öngörülebilmektedir. Gelecekte toplumu yüksek oranda etkileyebilecek çevresel sorunların, bugünden tedbirlerinin alınması, farkındalık kazanılması, gelecekteki olası büyük sorunlara tedbirli olunması açısından önem arz etmektedir. Araştırmanın hedef kitlesi olan eğitilmiş gençlerin değişen yaşam dinamiklerine adaptasyon yeteneklerinin yüksek olması, teknolojik gelişmelere en yakın kesim olması, eğitim sürecindeki gençlerin toplumla daha fazla etkileşim içerisinde olması, edindikleri meslekler sonrası sosyal ve ekonomik yaşam içinde aktif yer alacak olmaları gibi unsurları çalışma açısından önem taşımaktadır. Bu nedenle, somut sonuçlara ulaşabilmek ve hedef kitle özelinde tutum değişikliği oluşturabilecek farkındalık düzeyine erişilebilmek için araştırma evreninin belirli bir uzmanlığa odaklanmasına karar verilmiş ve Dokuz Eylül Üniversitesi Edebiyat Fakültesi lisans öğrencileri araştırma evreni olarak seçilmiştir. İzmir Dokuz Eylül Üniversitesi Edebiyat Fakültesi'nde yürütülen çalışma, gelecek nesilleri yönlendirme misyonuna sahip gençlerin katılımıyla gerçekleştirilmiştir. Yazarlar tarafından geliştirilen anket çalışmasına 104 kişi katılım sağlamıştır. Çalışma, niceliksel araştırma yöntemleri kullanılarak yürütülmüş olup, Dokuz Eylül Üniversitesi Edebiyat Fakültesi lisans öğrencileri evreninden seçilmiş örneklem üzerinden gerçekleştirilmiştir. Soru formundaki 23 soru için bir puanlama sistemi geliştirilmiştir. Puanlama sistemi, bireylerin farkındalık düzeyini ölçmeye odaklıdır. Anket uygulamasıyla hedef kitlenin konu hakkında farkındalık düzeyleri, ilgi düzeyleri, en yoğun kullandıkları dijital mecralar belirlenmiştir ve bunlara bağlı olarak çalışmanın iyiliği yönünde anket sonuçları analiz edilmiş, konuya ilişkin literatür taramaları yapılmıştır. Analiz aşamalarında örneklem grubunun demografik özellikleri tanıtarak, farkındalık düzeylerinin demografik değişkenlere göre farklılaşmaları araştırılmıştır. Farkındalık düzeylerinin belirlenmesinde kullanılan soru grubunun güvenilirliğini ölçen Cronbach's Alfa güvenilirlik katsayısı 0.904 elde edilmiştir.

**Anahtar Kelimeler:** İklim Değişikliği, Yeşil Mutabakat Eylem Planı, Dijital Farkındalık, Anket Analizi, Güvenilirlik

**Material Technology in Activity Therapy for the Elderly in Youth and Sports Clubs**

**Mürsel Akdenk<sup>1,2\*</sup>**

<sup>1</sup>Istanbul Esenyurt University; School of Physical Education and Sports: Istanbul-Türkiye.

<sup>2</sup>International University of Dublin; Sports Science Faculty; Medical Exercises Department; Integrated Professional Doctor Education Student: Dublin-Northern Ireland.

\*Corresponding author e-mail: murselakdenk06@gmail.com

***Abstract***

*Until today; In Youth and Sports Clubs in Turkey; Moreover, therapy work was not included; and studies such as Activity Therapy for the Elderly were never brought to the agenda. Based on this, it was not possible to use the terms Material Technology in Activity Therapy for the Elderly. In this field study; On the one hand; From the Elderly Activity Therapy Coaching Undergraduate Program; On the other hand, it is aimed to provide information and documents about the Turkey and Australia Model in Developments in Some Numerical Data and Applications, thanks to the relevant programs. Today; In every country and Turkey; There is an urgent need for innovative and useful studies in every field in carrying out different education and training programs in Youth and Sports Clubs in Turkey. Based on this; in relevant clubs; Child; adolescent; youth; There are adult and elderly members. Strange; Special Therapy Programs are included under the leadership of Youth and Sports Coaches. Even; "In Turkey; With the Law on Sports Clubs and Sports Federations dated April 26, 2022, the Youth Clubs Model is being removed from the system; 70 million young people, around 15 million elderly people, and around 22 million retirees are excluded from Sports and Activity Therapy. Key Words: 1-Youth and Sports Leadership; 2-Activity Therapy for the Elderly; 3-Youth Sports and Activity Therapy Education, Research and Application Center for the Elderly.*

**Keywords:** Youth and Sports Leadership, Activity Therapy for the Elderly, Youth Sports and Activity Therapy Education, Research and Application Center for the Elderly

## Topluluk Öğrenmesi Yöntemleri ile Sigorta Suistimallerinin Tespit Edilmesi

**Kübra Akıllı<sup>1\*</sup>, Selay Giray Yakut<sup>1</sup>**

<sup>1</sup>Marmara Üniversitesi, Finansal Bilimler Fakültesi, Aktüerya Bilimleri Bölümü, İstanbul, Türkiye

<sup>2</sup>Marmara Üniversitesi, İktisat Fakültesi, Ekonometri Bölümü, İstanbul, Türkiye

\*Sorumlu yazar e-mail: kubra.akilli@marmara.edu.tr

### Özet

Sigortacılık sektörü, güven ilişkisine dayalı doğası nedeniyle suistimale elverişli olan bir sektördür. Sigorta suistimali, bir sigorta sürecinde hileli bir sonuç elde etme amacıyla gerçekleştirilen tüm eylemleri kapsamaktadır. Türkiye’de farklı sigorta branşlarında farklı türde sigorta suistimallerine rastlanılsa da, en fazla suistimal araç sigortalarında yapılmaktadır. Makine öğrenmesi, doğru tahminlerde bulunulması ve tahmin performansının artırılması amacıyla örnek veriler veya geçmiş deneyimleri kullanan hesaplama yöntemleri, topluluk öğrenmesi ise belirli bir sınıflandırma veya regresyon görevi için birden fazla makine öğrenmesi modelini eğiten ve bu modellerin çıktılarını bir araya getiren makine öğrenmesinin bir öğrenme türü olarak tanımlanmaktadır. Bu çalışmada, Türkiye’deki sigorta sektöründe önemli bir paya sahip olan kasko sigortasına ait maddi hasar dosyalarında yapılan suistimallerin, dengeli olmayan verilerdeki sınıf dengesizliği sorununun bir çözümü olan SMOTE yöntemi kullanılarak, topluluk öğrenmesi yöntemlerinden Bagging, Random Forest, AdaBoost, Gradient Boosting ve XGBoost yöntemleri yardımıyla tespit edilmesi amaçlanmaktadır. Bu amaç doğrultusunda, Türkiye’de tüm sigorta şirketlerinin verilerini barındıran Sigorta Bilgi ve Gözetim Merkezi bünyesinde 2015 yılında faaliyete başlayan Sigorta Sahteciliklerini Engelleme Bürosundan (SİSEB) temin edilen son 5 yıla ait, kasko sigortasındaki maddi hasar dosyalarına ilişkin bilgileri içeren ve 1.272 adet suistimal tespit edilen ve 1.047.302 adet suistimal tespit edilmeyen toplam 1.048.574 adet ham veri ile veri kümesi oluşturulmuştur. Ham veri, veri ön işleme aşamasından geçirilerek ve suistimal olup olmadığına göre etiketlenilmiş sınıflar arasındaki dengesizliğin önüne geçilmek amacıyla SMOTE yöntemi kullanılarak analize hazır hale getirilmiştir. Topluluk öğrenmesi yöntemleri, kasko sigortasındaki suistimalin tespiti için uygulanmış ve bu yöntemlerin performansları doğruluk oranı başta olmak üzere farklı ölçütler kullanılarak değerlendirilmiştir. Yöntemlerin doğruluk oranları; Bagging yönteminde %85.2, Random Forest yönteminde %86.1, AdaBoost yönteminde %89.99, Gradient Boosting yönteminde %89.65 ve XGBoost yönteminde %90.18, Cohen Kappa İstatistikleri; Bagging yönteminde %69.58, Random Forest yönteminde %71.42, AdaBoost yönteminde %79.34, Gradient Boosting yönteminde %78.63 ve XGBoost yönteminde %79.58, ROC eğrisi altında kalan alanı ifade eden AUC değerleri; Bagging yönteminde 0.919, Random Forest yönteminde 0.935, AdaBoost yönteminde 0.949, Gradient Boosting yönteminde 0.940 ve XGBoost yönteminde 0.940 olarak elde edilmiştir. Sonuç olarak çalışmada kullanılan tüm topluluk öğrenmesi yöntemlerinin, kasko sigortasındaki suistimalin tespitinde yüksek performans sergilediği, AUC değerine göre AdaBoost yönteminin ve doğruluk oranı, Cohen Kappa istatistiği ölçütüne göre ise XGBoost yönteminin diğer yöntemlere göre daha iyi performans gösterdikleri belirlenmiştir.

**Anahtar Kelimeler:** Sigorta suistimali, Makine öğrenmesi, Topluluk öğrenmesi



## Girişimcilerin E-İhracat Eğilimleri: Engeller ve Çözüm Önerileri

**Abdullah Sağlam<sup>1\*</sup>, Abdullah Önden<sup>2</sup>**

<sup>1</sup>Yalova Üniversitesi, İktisadi ve İdari Bilimler Fakültesi, Uluslararası Ticaret ve Finansman, 77200, Yalova, Türkiye

<sup>2</sup>Yalova Üniversitesi, İktisadi ve İdari Bilimler Fakültesi, Uluslararası Ticaret ve Finansman, 77200, Yalova, Türkiye

\*Sorumlu yazar e-mail: abduallah.saglam@yalova.edu.tr

### Özet

*E-ticaret, teknolojinin gelişimi ve internetin de ortaya çıkmasıyla geleneksel ticaretten farklı yeni bir ticaret yöntemi olarak ortaya çıkmıştır. Gelişen teknoloji ve artan imkanlar, e-ticaretin ticaret yapabilme becerilerini iyice geliştirmiş ve bu da e-ticaretin toplam ticaret hacmi içindeki payını her geçen gün artırmıştır. Bu nedenle, e-ticaret dikkatlice incelenmesi gereken bir ticaret yöntemi haline gelmiştir. E-ticaretin gelişimiyle birlikte alt kategoriler de oluşmuştur. E-ihracat da bunlardan biridir. E-ihracat, artık sınırların öneminin azaldığı küresel bir dünyada ticaretin uluslararası boyutta gerçekleştirilmesini ve ürün ve hizmetlerin yurtdışına ihraç edilmesini sağlamaktadır. Girişimciler, e-ihracat sayesinde yerel pazarlardan çok daha büyük pazarlara ulaşma fırsatları bulmuşlardır. Müşteri portföylerini genişletmek ve kârlarını artırmak isteyen girişimciler, klasik ihracattan daha kolay ve pratik bir yöntem olan e-ihracatı hedef ülkelere veya pazaryerlerine yönelik olarak tercih etmektedirler. Ancak, girişimciler, e-ihracata başlarken ve devam eden süreçlerde engellerle karşılaşmaktadırlar. Bu araştırmanın temel amacı; yeni girişimcilerin e-ihracata başlarken ya da e-ihracat sürecinde karşılaşılabilecekleri ulusal veya uluslararası engellerini belirlemek ve bunlara çözüm önerileri sunmaktır. Böylece bu çalışma ile yeni girişimcilerin e-ihracat engellerine bakış açıları incelenecek ve değerlendirilecektir. Araştırmanın amacı doğrultusunda, girişimcilerin karşılaşılabilecekleri e-ihracat engelleri, araştırmaya dahil olan girişimci adayları kapsamında incelenmiş ve bu engelleri algılama düzeylerinin tespit edilmiştir. Araştırmada veri toplama aracı olarak anket yöntemi kullanılmıştır. Kullanılan anket formu, gelecekte girişimcilik faaliyetinde bulunması muhtemel olan 1137 kişiye internet aracılığıyla gönderilmiş ve anketi yanıtlamaları istenmiştir. Bu kişilerin 436 tanesi ankete geri dönüş sağlamıştır. Yapılan inceleme ve değerlendirmeler sonucunda, yanıtlanan 5 anketin analize uygun olmadığı görülmüştür. Ayrıca, 87 katılımcı gelecekte bir girişimcilik faaliyetinde bulunmayacaklarını belirtmiştir. Bu nedenle, araştırmaya 344 yeni girişimcinin yanıtladığı anketler dahil edilmiş ve gerçekleştirilen istatistiksel analizlerde bu anketlerden elde edilen veriler kullanılmıştır. Araştırma verilerinden elde edilen bulgulara göre, girişimci adaylarını gerçekleştirmeyi planladıkları e-ihracat süreçlerinde pazarlama ve ürün, ülke kuralları, pazar ve lojistik faktörlerinden kaynaklanan engeller algıladıkları tespit edilmiştir. Araştırma sonucunda; girişimci adaylarının algıladıkları e-ihracat engellerinin bağımsız değişkenlere göre faktör bazında farklılık gösterdiği belirlenmiştir. Bu bağımsız değişkenler arasında girişimci adaylarının cinsiyeti, yaşları, eğitim durumları, günümüzdeki meslekleri, girişimlerini kuracakları il ve faaliyet gösterecekleri sektör, girişimin büyüklüğü ve hedef uluslararası pazarlar bulunmaktadır. Bağımsız değişkenlerin, genel e-ihracat engelleri algısı, pazarlama ve ürün, ülke kuralları, pazar ve lojistik alt boyutlarında farklılık gösterdiği belirlenmiştir.*

**Anahtar Kelimeler:** Girişimcilik, E-ihracat, E-ihracat engelleri, Uluslararası ticaret

**Yatırım Araçlarının Enerji Değişimlerinin Faz Düzlemleri Aracılığıyla İncelenmesi**

**Burak Baran<sup>1</sup>, İstem Köymen<sup>1\*</sup>, İpek Deveci<sup>1</sup>**

<sup>1</sup> Dokuz Eylül Üniversitesi, İİBF, Ekonometri Bölümü, İzmir, Türkiye

\*Sorumlu yazar e-mail: istem.koymen@deu.edu.tr

**Özet**

*Bu çalışmada, Türkiye'deki insanların son yıllarda artan enflasyon nedeniyle yatırım yapma eğilimi ele alınmaktadır. Araştırma, yatırım araçlarının ekonomik dönemlere göre değişen davranışlarını anlamak için ikinci dereceden faz düzlemlerini kullanmaktadır. Bu düzlemler, enerji değişimlerinin ve sistemdeki dinamiklerin zaman eksenini boyunca görsel olarak incelenmesine olanak tanır. İki boyutlu faz düzlemi, bir yatay ve bir dikey eksen üzerinden potansiyel ve kinetik enerji ilişkisini yansıtır. Potansiyel enerji ivme ve kinetik enerji hızla ilgilidir. Sistemin iki durum arasında hareket ettiği harmonik davranış orijini çevreleyen bir döngü gösterir. Bu döngünün hareketinin orijin etrafında saat yönünde olması gereklidir. Döngünün yarıçapı büyüdükçe sistem daha fazla enerjiye sahip olur, bu da incelenen değişkenin hareketlerinin büyüklüğünü gösterir. Yatırım araçları olarak dolar, euro, BİST-100 endeksi ve çeşitli kripto paralar incelenmiştir. Dönem olarak ise pandemi sürecinin önemli etkisi de düşünülerek 2020-2023 yılları baz alınmıştır. Çalışma sonucunda özellikle pandemi sürecinde kripto paraların enerji değişimlerinin çok daha yüksek olduğu döngülerin genişliğinden görülmektedir. Diğer yatırım araçlarındaki dalgalanmalar ise çok daha küçüktür. Aynı zamanda faz düzlemleri benzer olan yatırım araçlarının benzer dalgalanmalar içerdiği de söylenebilir. Bu durumda özellikle gümüş ve altın, dolar ve Euro ve kripto paralar da kendi içlerinde benzer davranışlar göstermektedir. Bu bulgular, yatırımcıların tercihlerine yönelik bilgiler sunarak, daha bilinçli yatırım kararları alınmasına katkıda bulunabilir.*

**Anahtar Kelimeler:** Faz Düzlemi, Enerji Değişimi, Veri Analizi, Yatırım Araçları

## Karbondioksit Emisyonu ve Yenilenebilir Enerji Arzı Arasındaki İlişkinin Türkiye için İncelenmesi

Ayşe Nur Destebasi Abbas<sup>1\*</sup>, Turker Simsek<sup>1</sup>

<sup>1</sup>Tokat Gaziosmanpasa University, Economics and Administrative Sciences, Economics,  
60100, Tokat, Türkiye

\*Corresponding author e-mail: ayse.destebasi@gop.edu.tr

### Özet

Yenilenebilir enerji kaynakları, iklim değişikliğinin beklenenden hızlı bir biçimde artması nedeniyle bugün daha önemli bir konumdadır. Beklenenden hızlı bir sıcaklık artışı nedeniyle 2016 yılında birçok ülkenin katılımıyla Paris İklim Sözleşmesi imzalanmıştır. Sözleşmede ülkelerin 2053 yılına kadar net sıfır emisyon hedefine ulaşmak için enerji kaynaklarının tamamının yenilenebilir olması gerektiği öngörülmektedir. Türkiye, bu sözleşme kapsamında yenilenebilir enerji kaynaklarını artırma yolunda önemli adımlar atmaktadır. Ancak, mevcut çabalar karbondioksit emisyonlarını (CO<sub>2</sub>) azaltma konusunda yeterli görünmemektedir. Çalışmada, Türkiye'nin Paris İklim Sözleşmesi çerçevesindeki sera gazı emisyonlarını azaltma hedefi, karbondioksit emisyonu ve yenilenebilir enerji kaynakları üzerinden analiz etmek amaçlanmaktadır. Bu amaç doğrultusunda 1990-2020 yılları arasında kişi başına düşen CO<sub>2</sub> emisyonu, yenilenebilir enerji arzı ve kişi başına düşen reel gayri safi yurtiçi hasıla (GSYİH) verileri kullanılmıştır. Kişi başına düşen CO<sub>2</sub> verileri Dünya Bankası, yenilenebilir enerji arzı ve kişi başına düşen reel GSYİH ise Ekonomik İşbirliği ve Kalkınma Örgütü (OECD) veri tabanından temin edilmiştir. Analizler, Eviews 10 ve Stata/MP 18.0 paket programları kullanılarak gerçekleştirilmiştir. ARDL sınır testi yaklaşımı, hata düzeltme ve Toda Yamamoto Nedensellik analizleri kullanılmıştır. Test sonuçları, kişi başına düşen CO<sub>2</sub>, yenilenebilir enerji arzı ve kişi başına düşen reel GSYİH arasında uzun dönem ilişki olduğunu ortaya koymuştur. Kısa dönemdeki sapmaların yaklaşık olarak 0,72 dönemde (bir yıldan kısa bir zamanda) düzeldiği belirlenmiştir. Ayrıca, kişi başına düşen CO<sub>2</sub>'den yenilenebilir enerji arzına ve yenilenebilir enerji arzından CO<sub>2</sub>'ye doğru nedensellik ilişkileri tespit edilmiştir. Bulgular doğrultusunda Türkiye'nin yenilenebilir enerji kaynaklarına yönelmesi 2053 net sıfır emisyon hedeflerini gerçekleştirmek için önem arz etmektedir. Süreci desteklemek için fosil yakıtların tüketiminin hızla azaltılmasına yönelik sürdürülebilir politikaların arttırılması ayrıca etkili olacaktır. Özetle fosil yakıt kaynaklarının payının azaltılırken, buna oranla yenilenebilir enerji kaynaklarının payının arttırılması çalışmanın nihai önermesidir.

**Anahtar Kelimeler:** CO<sub>2</sub> emisyonları, Yenilenebilir Enerji Arzı, ARDL Sınır Testi, Hata Düzeltme, Toda Yamamoto Nedensellik.



**Effect of Different Growing Mediums on Nutritional Values and Plant Development of Edible Flowers**

**Güzella Yılmaz Vural<sup>1\*</sup>**

<sup>1</sup>Tokat Gaziosmanpaşa University, Faculty of Agriculture, Department of Horticulture, Tokat, Türkiye

\*Corresponding author e-mail: guzella.yilmaz@gop.edu.tr

***Abstract***

*The study was conducted to determine the differences in nutritional values and plant development of edible flowers with high commercial value, which have recently been frequently used in the field of gastronomy when grown in different growing environments. In the study, Calendula (Calendula officinalis L.), Electric Flower (Spilanthes oleracea), Red Nasturtium (Tropaeolum majus L.) and Yellow Nasturtium (Tropaeolum majus L.) were used. Plants are propagated by seeds. When the plants had 2-3 leaves, they were taken from the peat medium in which the seeds were planted and transplanted into the prepared growing media. The experiment was carried out in 3 different growing media: soil, peat and biochar added soil. After the plants were transplanted, fertilizer was applied to the pots containing only the soil mixture. Biochar used in the growing medium with added biochar is material enriched with liquid animal manure. As a result of the study, according to the measurement results for plant growth, it was determined that plants grown in pots containing peat or biochar had better growth and development compared to plants grown in pots containing soil. To determine the nutritional values of the flowers, the P, K, Mg, S, Ca, Fe, Zn, Mn, Cu, B, Mo, Cd, Co, Cr, Ni and Pb contents of the plants were determined. It has been determined that nutrients beneficial to human health are found at higher levels in plants grown in biochar-added and peat growing media. Differences have been observed in the amounts of elements called heavy metals, which have a negative effect on plant growth and development and are also harmful to human health, depending on the growing media and plant species. Each of the growing media had negative effects for some heavy metals and positive effects for some heavy metals.*

**Keywords:** Edible Flower, Nutrient Elements, Biochar

## Blockchain for Information Centres and Libraries: Systematic Review and Meta Analysis

**Faiza Bashir<sup>1\*</sup>, Nosheen Fatima Warraich<sup>2</sup>**

<sup>1</sup>Higher Education Department, Government of the Punjab, Lahore, Pakistan

<sup>2</sup>Institute of Information Management, University of the Punjab, Lahore, Pakistan

\*Corresponding author e-mail: faizavirgo@yahoo.com

### **Abstract**

*Disruptive technologies change the face of libraries and information centres during the last two decades. Blockchain technology is among one of the top emerging technologies transforming every sector of society. Blockchain technology presents a big opportunity for libraries to leverage this technology and make the most of it by putting it into the appropriate context. Blockchain technology also has the potential to become a strong tool for information and record management. The general task in libraries has been impacted by this technology; in particular, the acquisition of document kinds has expanded to include electronic and digital items. Keeping track of these resources is likewise getting harder every day. Technology offers the ideal answer to those problems. The purpose of this study is to show how blockchain technology is relevant to libraries and LIS professionals, as well as to highlight potential advantages and potential problems associated while using blockchain technology. Review of the previous literature shows that LIS professionals doesn't seem to be much aware about the features and capabilities of this technology. There might be reasons behind this phenomenon that people don't realize that how important blockchain technology for LIS domain. An established technique that offers a transparent, auditable, and repeatable trail of the decisions, processes, and conclusions of the reviewers is the systematic review and meta-analysis of academic literature (Bryman and Cramer, 2012). This research study will be conducted using the Preferred Reporting Items for Systematic Reviews and Meta-Analyses 2020 checklist.*

*The results of this meta-analysis and literature review, it is anticipated that it will provide the basic understanding and fundamental features of this emerging technology for LIS domain. Moreover, the results will map out the obstacles associated with this technology.*

**Keywords:** Blockchain, Library and Information Professionals, Libraries, SLR, Meta Analysis

**The Role of Business Systems Leveraging on the Supply Chain Performans with the Effect of Information Sharing as The Mediator: The Case of Manufacturing Firms**

Nurdan Çolakoğlu<sup>1</sup>, Özlem Akçay Kasapoğlu<sup>2</sup>, Aslıhan Sağıroğlu<sup>1\*</sup>

<sup>1</sup>Arel University, Faculty of Engineering, Industrial Engineering Department, 34800, Istanbul, Türkiye

<sup>2</sup>Istanbul University, Faculty of Business, Operations Management Department, 34800, Istanbul, Türkiye

\*Corresponding author e-mail: aslihansagioglu@arel.edu.tr

**Abstract**

*In this uncertain world, doing business is like walking in a foggy forest. Supply chain disruptions with the changing global trade routes, increasing risks and making the companies focusing more on their resiliency and responsiveness. Integration in supply chain and information sharing all though the chain became more important than ever while planning is getting harder in this uncertain environment. Sharing information helps the companies to proactively identify and mitigate risks. Business Sytems leveraging ensures that integration of hardware, software and standards are succesfully done to able to let the data flow through the organization easily for making the information sharing possible. Business sytems leveraging is the level that the members althrough the supply chain willing to combine their sytems. When companies leverage their business systems, they are better able to perform and coordinate these activities, including procurement, manufacturing, and shipping, lowering the related costs and increasing the efficiency. Supply chain members conjoint their business sytems to improve their information sharing. It is known that lack of information sharing might cause bullwhip effect in supply chain. Members share information in the supply chain to able to predict or pull the demand better so that they can improve the operational execution and support the inventory related decisons that should be organized in houlistic approach. Information sharing in supply chain helps to decrease the inventory by improving the coordination in supply chain. Mediator effect of information and the business sytems leverage help the companies to deal with uncertainty and increase their competitive advantage. Increased visibility of material usage reduces the distortion of actual demand, allowing companies to run more efficiently and it is found that supply chain integration has a positive impact on supply chain resilience. In this paper we asked two hunderdand seventy manufacturing companies and their understanding on their supply chains. Structural equation modeling (SEM) is used to analyze the survey data and it is found that business systems levaraging effecting the supply chain management performans with the mediator effect of information sharing, even effecting the supply cahin performance more. This paper contributes to the supply chain literature by providing theoretical understanding and emprical results of how business sytems leverage and information sharing in the supply chain can work together to boost supply chain performance.*

**Keywords:** Business Levarage, Information Sharing, Supply Chain Performance



**Statistical Inference of Process Capability Index  $C_{pm}^*$  for the Chen Distribution with Application**

**Kadir Karakaya**<sup>1\*</sup>

<sup>1</sup>Selçuk University, Faculty of Science, Department of Statistics, 42130, Konya, Türkiye

\*Corresponding author e-mail: kkarakaya@selcuk.edu.tr

**Abstract**

*Quality control engineers use the process capability index to monitor the capability of a process. The process capability index indicates whether the products meet the required specifications. Classic indices like  $C_{pm}$  are commonly used when measurements follow the normal distribution. However, the distribution of measurements may not always follow a normal distribution, thus requiring alternative process capability indices. One alternative to the  $C_{pm}$  index is the  $C_{pm}^*$  index introduced by Karakaya (2024). The  $C_{pm}^*$  index is quantile-based, can be applied to both normal and non-normal measurements, and serves as a generalized form of the conventional  $C_{pm}$ . This study examines the  $C_{pm}^*$  index based on the Chen distribution. The maximum likelihood estimation of  $C_{pm}^*$  is studied, and interval estimation is conducted using the approximate confidence interval based on the Fisher Information principle. The performance of point and interval estimations is evaluated through Monte Carlo simulation. The usability of the  $C_{pm}^*$  in the field of engineering is also demonstrated using a real data analysis.*

**Keywords:** *Chen Distribution, Maximum Likelihood Estimation, Process Capability Index, Ball-size data*

**Otoregresif Kesirli Bütünleşik Hareketli Ortalama (ARFIMA) Modelinin Belirlenmesi:  
Türkiye, Hindistan ve Brezilya Ülkeleri Üzerine Uygulama**

**Semanur Sarıcam<sup>1\*</sup>, Barış Aşıkil<sup>2</sup>**

<sup>1</sup>Marmara Üniversitesi, Fen Fakültesi, İstatistik, İstanbul, Türkiye

<sup>2</sup>Mimar Sinan Güzel Sanatlar Üniversitesi, Fen-Edebiyat Fakültesi, İstatistik, İstanbul, Türkiye

\*Sorumlu yazar e-mail: [semanur.saricam@marmara.edu.tr](mailto:semanur.saricam@marmara.edu.tr)

**Özet**

*Bu çalışmanın amacı, Türkiye, Hindistan ve Brezilya ülkelerine ait petrol kiralalarının otoregresif kesirli bütünleşik hareketli ortalama modeli ile incelenmesidir. Bu çalışma için, petrol kiralalarına ait 1970-2016 yıllarını kapsayan veriler dahil edilerek ARIMA ve ARFIMA modelleri kullanılmıştır. İlk olarak, petrol kiralalarına ait Türkiye, Hindistan ve Brezilya serilerinin durağanlığını test etmek için klasik birim kök yöntemleri kullanılmıştır. Serilerin uzun hafızaya sahip olup olmadığı Hurst'ün R/S istatistiği ile belirlendikten sonra  $p, q \leq 2$  için olası tüm ARIMA ve ARFIMA modelleri denenmiştir. En uygun model belirlendikten sonra ileriye yönelik tahminlere gidilmiştir.*

**Anahtar Kelimeler:** Uzun hafıza, ARIMA modeli, ARFIMA modeli, Petrol kiralaları

## Anomaly Detection for Retail Stores' Rental Payments: A Forecasting Approach

Nuran Senözgel<sup>1\*</sup>, İbrahim Emiroğlu<sup>1</sup>

<sup>1</sup>Yildiz Technical University, Faculty of Chemistry and Metallurgy, Mathematical Engineering, 34220, Istanbul, Türkiye

\*Corresponding author e-mail: nuran.senozgel@std.yildiz.edu.tr

### *Abstract*

*It is important to detect in advance any incorrect payments that may occur in the rents paid by retail companies for their stores because both underpaid and overpaid rents can harm the company. Rental payment methods of retail companies can be divided into two: fixed and sales-based. In sales-based rent payments, anomaly situations can be detected by predicting store sales amounts and comparing them with actual sales. Along with detecting anomaly, it is also important to find the cause. The time series forecasting method can be used for many fields of study. In this study, the time series forecasting method was used to determine whether there is an anomaly in the rent payments of retail stores, whose rent is determined based on monthly sales, were selected. From the monthly sales data of the selected stores between 2021 and 2023, the years 2021 and 2022 were used for training the prediction model, while the year 2023 was used for testing. As a statistical method, monthly estimates of sales in the store were made using The Autoregressive Integrated Moving Average (ARIMA) method. In determining the (p, d, q) values for the ARIMA model, different p, d, and q values were tried for the best estimate. As a result, the anomaly was not detected between the estimated sales and actual sales of the selected stores.*

**Keywords:** Time Series Forecasting, Statistical Method, ARIMA Model, Anomaly Detection



## A Novel Two-layer Feature Selection Method

Deniz Inan<sup>1</sup>, Burak Arkanoz<sup>1</sup>, Nuriye Sancar<sup>2\*</sup>

<sup>1</sup>Department of Statistics, Marmara University, Istanbul, Turkey

<sup>2</sup>Department of Mathematics, Near East University, Nicosia, North Cyprus via Mersin, Turkey

\*Corresponding author e-mail: nuriye.sancar@neu.edu.tr

### *Abstract*

*Feature selection plays a critical role in the prediction performance of the model during the modeling process. It enables the model to provide more robust predictions by reducing the complexity of the model through effective variable selection and preventing the risk of overfitting. In this study, a metaheuristic optimization-based two-layer feature selection method was designed. The performance of the suggested feature selection method was compared with existing methods with various performance evaluation criteria on the real data set and simulated data. According to the comparison results, the suggested feature selection method has shown better performance than other methods.*

**Keywords:** Feature Selection, Two-layer Method, Metaheuristic Optimization Method



## Gene Selection Using Binary Tuna Swarm Optimization

**Eda Özkul<sup>1\*</sup>, Özge Tezel<sup>1</sup>**

<sup>1</sup>Karadeniz Technical University, Faculty of Science, Department of Computer Sciences, 61080,  
Trabzon, Türkiye

\*Corresponding author e-mail: eda.ozkul.gs@gmail.com

### *Abstract*

*Gene selection is a feature selection process that is widely used in machine learning, data mining and pattern analysis. Gene selection problem has a large number of genes which include relevant, redundant and noise. Developments in bioinformatics show that reducing the number of genes is an important factor for more effective and faster diagnosis of diseases. In this problem, computational complexity is reduced by selecting small number of genes. However, it is necessary to choose the relevant genes in order to maintain high level of accuracy. In this purpose, researchers have proposed several feature selection (FS) methods to select the relevant genes. In this study, the binary tuna swarm optimization algorithm (BTSSO) is proposed and applied to gene selection problem. Thus, BTSSO select the most relevant genes for a disease from microarray data. The performance of the proposed method is demonstrated by applying various classifiers to the selected gene subsets and different evaluation criteria such as accuracy, recall, precision, F1-score and confusion matrix are used. The experimental results demonstrate that the proposed method can reduce the dimensionality of the microarray dataset, identifying the most informative gene subset, and improving classification accuracy.*

**Keywords:** *Gene Selection, Tuna Swarm Optimization, Binary Optimization, Feature Selection.*

## Binary Chernobyl Disaster Optimizer for 0-1 Knapsack Problems

**Özge Tezel<sup>1\*</sup>, Eda Özkul<sup>1</sup>**

<sup>1</sup>Karadeniz Technical University, Faculty of Science, Department of Computer Sciences, 61080, Trabzon, Türkiye

\*Corresponding author e-mail: ozge\_tzl@hotmail.com

### *Abstract*

*The Chernobyl Disaster Optimizer (CDO) has recently been introduced metaheuristic algorithm inspired by the explosion in the 4th reactor of the Chernobyl nuclear power plant in 1986. Although the original CDO demonstrates excellent performance in solving continuous problems, it cannot be applied directly to the binary problems such as the 0-1 knapsack problem. The 0-1 Knapsack problem (0-1 KP) is one of the well-known NP-hard combinatorial optimization problem that is a challenging problem to solve efficiently using conventional techniques. The objective of this problem is to identify the optimal subset of items from a given set, with its own specific profit and weight, that maximizes profit while remaining within the capacity of the knapsack. Different methods have been proposed to solve the 0-1 knapsack problem. In this paper, the binary CDO algorithm is proposed to solve the 0-1 Knapsack problems and called as BCDO. Original CDO is adapted to 0-1 KP using S shaped transfer function. Several experiments were performed to compare the performance of the BCDO to several competing optimizers when solving 25 benchmark knapsack instances with different dimensions. The experimental results show the superiority of the proposed binary CDO algorithm.*

**Keywords:** 0-1 Knapsack Problem, Chernobyl Disaster Optimizer, Binary Optimization, Combinatorial Optimization, Transfer Function.



## Evaluation of Machine Learning Algorithms Based on Particle Swarm Optimization and Elastic Net Feature Selection for Heart Disease Prediction

Nimet Yapıcı Pehlivan<sup>1\*</sup>, Muhammed Nurullah Kutlu<sup>2</sup>, Özlem Akarçay Pervin<sup>3</sup>  
Halil Osman Erbek<sup>1</sup>

<sup>1</sup>Selçuk University, Science Faculty, Department of Statistics, 42250, Konya, Türkiye

<sup>2</sup>Selçuk University, Institute of Science and Technology, Department of Statistics, 42250, Konya, Türkiye

<sup>3</sup>KTO Karatay University, Vocational School of Commerce and Industry, Department of Computer Programming, 42010, Konya, Türkiye

\*Corresponding author e-mail: nimet@selcuk.edu.tr

### *Abstract*

*High-dimensional data, which has attracted great attention in recent years with the development of artificial intelligence and machine learning techniques. When a large number of features in high-dimensional data, unnecessary and irrelevant features may cause the model to overfit and increase the error rate of the machine learning algorithm. To solve these problems, "dimensionality reduction" techniques are carried out. The most commonly used approaches to dimensionality reduction are "feature selection (FS)" and "feature extraction (FE)". Feature selection (FS) process aims to obtain a subset of relevant features from the original dataset to speed up machine learning algorithms and also improve prediction accuracy. Feature selection (FS) methods are generally classified into three categories as filter, wrapper and embedded methods. Particle Swarm optimization (PSO), one of the meta-heuristics algorithms, fall into the category of the wrapper FS methods. Elastic Net is one of the best-known embedded FS approaches which are a combination of filter and wrapper methods combining the FS process and the learning process into a single optimization problem.*

*In this study, the most relevant features are first determined by applying PSO and Elastic Net feature selection methods. Then, various machine learning algorithms such as K-nearest neighbor, Support Vector Machine, Decision Tree, Random Forest, and Logistic Regression are performed to classification aim. A comparative analysis is performed through different performance metrics, accuracy, precision, recall, F-score, and Matthew correlation coefficient to evaluate the performances of the feature selection based machine learning algorithms for heart disease prediction.*

**Keywords:** *Feature selection methods, Machine learning algorithms, Multi-criteria decision-making (MCDM) methods, Performance metrics.*

**Üretim İşletmelerinde Çalışan Eğitimi için Kullanılacak Sanal Gerçeklik Gözlüğü Seçim Probleminin Geliştirilmiş Bulanık Swara ve Bulanık Copras Yöntemleri ile Değerlendirilmesi**

**Hakan Aşan<sup>1\*</sup>, Ejder Ayçin<sup>2</sup>**

<sup>1</sup>Dokuz Eylül Üniversitesi, İzmir, Türkiye

<sup>2</sup>Kocaeli Üniversitesi, Kocaeli, Türkiye

\*Sorumlu yazar e-mail: hakan.asan@deu.edu.tr

**Özet**

Üretim işletmelerinde özellikle operasyonel seviyede personel değişimi sıklıkla gözlenmektedir. Her yeni personelin makine ve ekipmanların kullanımını öğrenmede eğitime ihtiyacı bulunmaktadır. Yeni çalışanların bu eğitimi makineler yardımıyla uygulamalı olarak alması, işletmenin süreçlerinin yavaşlamasına hatta durmasına neden olabilmektedir. Ayrıca yeni personel alımı dışında, işletmenin hali hazırdaki çalışanları için de sürekli eğitim çalışmaları yapılmaktadır. Çalışan eğitim programları için yeni teknolojilerden birisi olan sanal gerçeklik uygulamalarından destek alınması, karşılaşılan birtakım sorunları ortadan kaldıracaktır. Sanal gerçeklik teknolojisi, verilecek eğitimin aslına benzer bir sanal dünyada yapılmasını ve kullanıcıların daha etkileşimli, akılda kalıcı bir eğitim almalarını sağlayacaktır. Bu çalışmada üretim işletmelerinde personel eğitimi amacıyla kullanılması planlanan sanal gerçeklik gözlüklerinin seçimine yönelik, bulanık çok kriterli karar verme yöntemlerinin kullanıldığı bir araştırma yapılmıştır. Öncelikle üretim işletmelerindeki personel eğitiminde dikkate alınacak hususlar gözetilerek gözlük seçimine ait kriterler belirlenmiştir. Bu kriterlerin önem ağırlıkları uzman görüşüne dayalı bir yöntem olan Geliştirilmiş Bulanık SWARA yöntemi ile hesaplanmıştır. Ardından sanal gerçeklik gözlük alternatifleri Bulanık COPRAS yöntemi ile değerlendirilmiştir. Bulanık çok kriterli karar verme yöntemlerinin kullanıldığı bu uygulamanın, karar vericilere sanal gerçeklik gözlüğü seçiminde yardımcı olacak bir model önerisi olacağı tespit edilmiştir.

**Anahtar Kelimeler:** Sanal Gerçeklik, Gözlük, Geliştirilmiş Bulanık SWARA, Bulanık COPRAS

## Emerging Technologies for Educational Purposes: A Case Study of Urdu Literature Students

Almas Khanum<sup>1\*</sup>, Saima Iram<sup>1</sup>, Maria Amin<sup>1</sup>, Hammad Niazi<sup>1</sup>, Safeer Haider<sup>1</sup>

<sup>1</sup>Government College University, Department of Urdu, Lahore, Pakistan

\*Corresponding author e-mail: dr.almaskhanum@gcu.edu.pk

### Abstract

*During the last two decades technologies change the whole scenario of education. During Covid-19 world has witnessed the dramatic change of behaviour towards technologies for educational purpose. During the lockdown education has shifted for traditional mediums to online. Situation is similar in Pakistan for students as well. Urdu literature students incorporate technology as educational medium. The influence of emerging technologies on education is a crucial aspect to explore, particularly in developing countries such as Pakistan. The main objective of this present study is to explore the use of emerging technologies for education and research among Urdu literature students. Moreover, challenges and benefits associated with technological advancement on literature students is another objective of the study. Additionally, this study will map out the core technologies used among Pakistani students. A quantitative questionnaire survey of study will be use adopt to fulfil the study's aims. The population for this research will be consist of four main public universities in Lahore with the aid of the convenient sampling approach, from classmates of BA (HONS), MA, as well as M.Phil in Lahore. This research has the potential to shed light on the role of technology for literature education and in promotion of sustainable societies and to provide insights into how Urdu literature learning integrate educational technologies in Pakistan. Overall, the first study on the topic in Pakistan is an important step towards building a better understanding of the relationship between Urdu literature students and emerging technologies, and how this can be leveraged to promote sustainable behavior and attitudes among Pakistani students.*

**Keywords:** Emerging Technologies, Urdu Literature, Developing country, Education, Pakistan



## Kredi Kartı Kullanıcılarının Sadakat Puanlarının RFMD Tabanlı Hesaplanması ve Makine Öğrenimi Uygulamaları

**Bezza Nur Aydoğan<sup>1\*</sup>, Öyküm Esra Yiğit<sup>2</sup>**

<sup>1</sup>Yıldız Teknik Üniversitesi, Fen Bilimleri Enstitüsü, Veri Bilimi ve Büyük Veri Bölümü, 34220, İstanbul, Türkiye

<sup>2</sup>Yıldız Teknik Üniversitesi, Fen-Edebiyat Fakültesi, İstatistik Bölümü, 34220, İstanbul, Türkiye

\*Sorumlu yazar e-mail: bezzanur.aydogan@live.co.uk

### Özet

Piyasalar rekabetçi hale geldikçe ve sürekli değiştikçe her müşterinin kendine özel bir değeri olmuştur. Kuruluşlar müşterilerin sadakatini koruyarak rekabet avantajlarını artırmaya çalışmakta ve dolayısıyla belirli ihtiyaçlar/talepler doğrultusunda müşterileri elde tutmak adına müşteri sadakati kavramına oldukça önem vermektedir. Bu çalışmada, özel bir katılım bankasının kredi kartı müşterilerine ait sadakat skorunu hesaplamada RFM (recency, frequency ve monetary) tabanlı bileşik bir prosedür önerilmektedir. Önerilen prosedürde öncelikle uzman kişilerden elde edilen anket sonuçları değerlendirilmiş ve entropi ve çok kriterli karar verme tekniklerinden bulanık-AHP yöntemi ile ağırlıklar bulunmuştur. Yaklaşık 5000 adet müşteri verisine ait RFMD niteliklerine, k-means algoritması ile kümeleme yapılmış ve ardından her kümenin sadakat skoru hesaplanmıştır. Kümeleme sonucunda her bir müşteriye ait sadakat skoru hesaplanmış ve bu skorun belirlenen eşik değerin altında/üstünde olmasına göre müşterilere sadakatsiz/sadakatli olacak şekilde 0/1 etiketleri atanmıştır. Müşterilerin sadakat etiketini etkileyen faktörler lojistik regresyon, rastgele orman, destek vektör makineleri gibi makine öğrenmesi tekniklerinde sıklıkla kullanılan sınıflandırma algoritmaları ile modellenmiş ve kurulan modellerin performansları farklı performans metrikleri kullanılarak karşılaştırılmıştır. Bu çalışma ile önerilen prosedür ile sadakat skoru bazlı segmentleri belirlemenin ve tahmin etmenin bankanın kampanya içeriklerini özelleştirmesine katkı sağlayacağı düşünülmektedir.

**Anahtar Kelimeler:** RFMD Modeli, Entropi, Bulanık-AHP, Makine Öğrenmesi, Müşteri Sadakati

## Genetic Literacy from the Big Data Analytics Perspective

Gülşah Keklik<sup>1\*</sup>

<sup>1</sup>Istanbul Technical University, Eurasia Institute of Earth Sciences, 34469, İstanbul, Türkiye

\*Corresponding author e-mail: gulsahkeklik@gmail.com

### *Abstract*

*Data is a unit of information that can be recorded, reorganised and analysed. Big data analytics is where advanced analytical techniques work on large data sets. Big data sets are collected in areas such as social networks, digital signals, health, science and other similar areas, and almost every data set has the potential to be big data. Reading and understanding big data, exploring its methods and techniques, applications and solutions is possible with advanced data literacy. Computer scientists, mathematicians, statisticians, geneticists, bioinformaticians and other academics are working to access large amounts of information. Genetic literacy measures an individual's knowledge of genetic principles and their ability to apply this genetic knowledge to their treatments. Many patients, medical students and health care providers have problems due to their lack of knowledge in the use of genetic technologies. With the increase in the genetic literacy rate of individuals, the participation in tests for the diagnosis and treatment of genetic disorders increases in direct proportion. In this study, it is aimed to examine the concept of genetic literacy from the perspective of big data analytics with applied samples (through the disciplines such as bioinformatics and biostatistics).*

**Keywords:** *Big data analytics, Bioinformatics, Biostatistics, Data literacy, Genetic literacy.*

**Veri Analitiği Destekli Pazar Analizi: Havacılık Sektöründe Resmî Tatil Dönemlerinde Gelir Artışı**

**Sevval Hazan Aşık<sup>1\*</sup>, Öyküm Esra Yiğit<sup>2</sup>**

<sup>1</sup>Yıldız Teknik Üniversitesi, Fen Bilimleri Enstitüsü, Veri Bilimi ve Büyük Veri Bölümü, 34220, İstanbul, Türkiye

<sup>2</sup>Yıldız Teknik Üniversitesi, Fen- Edebiyat Fakültesi, İstatistik Bölümü, 34220, İstanbul, Türkiye

\*Sorumlu yazar e-mail: sevalhazan.asik@gmail.com

**Özet**

Özel dönemlerin, özellikle resmi tatil dönemlerinin, havacılık sektöründe gelir ve satışlar üzerindeki önemi büyüktür. Bu dönemler, havayolu şirketleri için önemli bir gelir kaynağı oluştururken, sektörün genel performansını da belirleyici şekilde etkiler. Tatil dönemlerindeki artışlar, havayolu gelirlerinde belirgin yükselişlere neden olabilir ve bu nedenle sektör temsilcileri için stratejik bir odak noktası haline gelir. Bu dönemlerin analizi, havacılık şirketlerinin gelirlerini artırmak için doğru stratejiler geliştirmelerine ve gelecekteki tatil dönemlerini daha etkin bir şekilde yönetmelerine yardımcı olabilir. Bu çalışma, resmi tatil dönemlerinin havacılık sektöründeki gelir üzerindeki etkisini analiz etmeyi ve bu etkinin büyüklüğünü belirlemeyi amaçlamaktadır. Bu çalışmada, lineer ve lineer olmayan regresyon yöntemleri kullanılarak tarih, yolcu sayısı, lokasyon, seyahat noktaları ve birim fiyatı gibi çeşitli değişkenler modele girdi olarak alınmıştır. Özellikle İstanbul çıkışlı yerel yolcuların seyahat tercihlerinin O&D (origin & destination) analizleri tüm pazarlar üzerinde yapılmıştır. Analizlerde kullanılacak olan veri setleri, sektörün tarih boyunca nasıl değiştiğini anlamaya ve gelecekteki resmi tatil dönemlerinin havayolu gelirlerini nasıl etkileyebileceğini öngörmeye olanak tanımaktadır. Bu çalışmanın sonuçları, resmi tatil dönemlerinin havacılık sektöründe satışlarda belirgin artışlarla sonuçlandığını göstermektedir.

**Anahtar Kelimeler:** Gelir Yönetimi, Pazar Analizi, Lineer Regresyon, Non-Lineer Regresyon, Havacılık Endüstrisi, Veri Analitiği



## Advanced Technology-Assisted Mental Health Monitoring and Intervention System: An İot-Based Approach

Elif Erdal<sup>1\*</sup>

<sup>1</sup>Tokat Gaziosmanpasa University, Engineering and Architecture Faculty, Mechatronics  
Engineering, 60030, Tokat, Türkiye

\*Corresponding author e-mail: erdalselif@gmail.com

### *Abstract*

*In the rapidly evolving landscape of healthcare technology, the integration of Internet of Things (IoT) devices has emerged as a promising avenue for revolutionizing the management of mental health disorders. This research proposes the conceptualization and development of an innovative IoT-based device tailored to capture and analyze data pertaining to the human mind, with a specific focus on patients diagnosed with panic attacks, and dementia. This device serves as a visionary tool, envisioned to transcend the boundaries of traditional healthcare by providing real-time insights into patients' mental states and facilitating proactive interventions. The IoT device under development is designed to capture a myriad of data points related to patients' cognitive and emotional states. Leveraging sensors and data collection mechanisms, the device monitors physiological indicators such as heart rate variability, skin conductance, and sleep patterns, alongside behavioral cues such as activity levels and speech patterns. This comprehensive dataset forms the foundation for sophisticated machine learning algorithms that analyze patterns and trends, offering valuable insights into patients' mental health status. One of the key features of the IoT device is its ability to provide real-time monitoring of patients' mental health status. In the event of an emergency, such as a severe panic attack or cognitive decline in dementia patients, the device triggers automatic notifications to designated caregivers or healthcare providers. This immediate response capability ensures timely interventions and enhances patient safety. In addition to real-time monitoring, the IoT device generates weekly reports summarizing patients' mental health trends and fluctuations. These reports serve as valuable tools for healthcare professionals, enabling them to track longitudinal changes in patients' conditions and tailor treatment plans accordingly. Furthermore, the device facilitates data analysis at scale, leveraging big data techniques to identify correlations, predict exacerbations, and optimize therapeutic interventions. In conclusion, the development of an IoT-based device for monitoring mental health represents a significant step forward in the field of healthcare technology. By offering real-time insights, proactive interventions, and comprehensive data analysis capabilities, this device has the potential to revolutionize the management of mental health disorders, enhancing patient outcomes and quality of life. As the research progresses, further refinements and advancements in device functionality are anticipated, paving the way for a future where technology seamlessly integrates with healthcare to deliver personalized, effective, and accessible mental healthcare solutions.*

**Keywords:** IoT, Mental Health, Real-Time Monitoring, Big Data Analysis, Proactive Intervention

**İklim Değişikliği Göstergelerinden Olan Aylık Maksimum Sıcaklık Değişiminin  
Fonksiyonel Veri Analizi ile İncelenmesi: Antalya İli Örneği**

**İsmail Kaya<sup>1</sup>, İstem Köymen<sup>2\*</sup>**

<sup>1</sup>Amasya Üniversitesi, Suluova Meslek Yüksekokulu, Mülkiyet Koruma ve Güvenlik Bölümü,  
Amasya, Türkiye

<sup>2</sup>Dokuz Eylül Üniversitesi, İİBF, Ekonometri Bölümü, İzmir, Türkiye

\*Sorumlu yazar e-mail: istem.koymen@deu.edu.tr

**Özet**

*İklim değişikliğinin en temel göstergelerinden biri yıllar boyunca aylık maksimum sıcaklıktaki artıştır. Bu amaçla aşırı hava olaylarının son yıllarda ülkemizde en belirgin olduğu il olan Antalya ili ele alınmış ve 1985-2023 yılı aylık verileri 9 istasyon bazında incelenmiştir. Tüm yıllar birlikte incelendiğinde sıcaklık eğrilerinin düzenli bir artış gösterdiği görülmekle birlikte iniş çıkışların büyüklüğünün de belirgin bir şekilde yıllar geçtikçe arttığı görülmektedir. Fonksiyonel veri analizi ile çalışmada elde edilen 9 istasyona ait eğrilerin türevlenebilir fonksiyonlar olması sıcaklık eğrilerindeki hızı ve ivmeyi veren birinci ve ikinci türev fonksiyonlarının da incelenbilmesine imkan vermiş ve sıcaklık eğrilerindeki iniş ve çıkışların boyutları da istasyonlar bazında çok daha kolay karşılaştırılabilir duruma gelmiştir. Bununla birlikte fonksiyonel kümeleme analizi ile bu yıllar boyunca birlikte değişim gösteren istasyonlardan oluşan 4 temel küme belirlenmiş ve bu doğrultuda kümelenmenin altında yatan iklimsel nedenler ortaya konularak iklim eylem planlarında iklim değişikliğine ilişkin ortak öneriler geliştirilmiştir.*

**Anahtar Kelimeler:** İklim Değişikliği, Aylık Maksimum Sıcaklık Verileri, Fonksiyonel Veri Analizi, Fonksiyonel Kümeleme Analizi

## Modelling of Count Data in Circular Statistics

**Feridun Tasdan**<sup>1\*</sup>

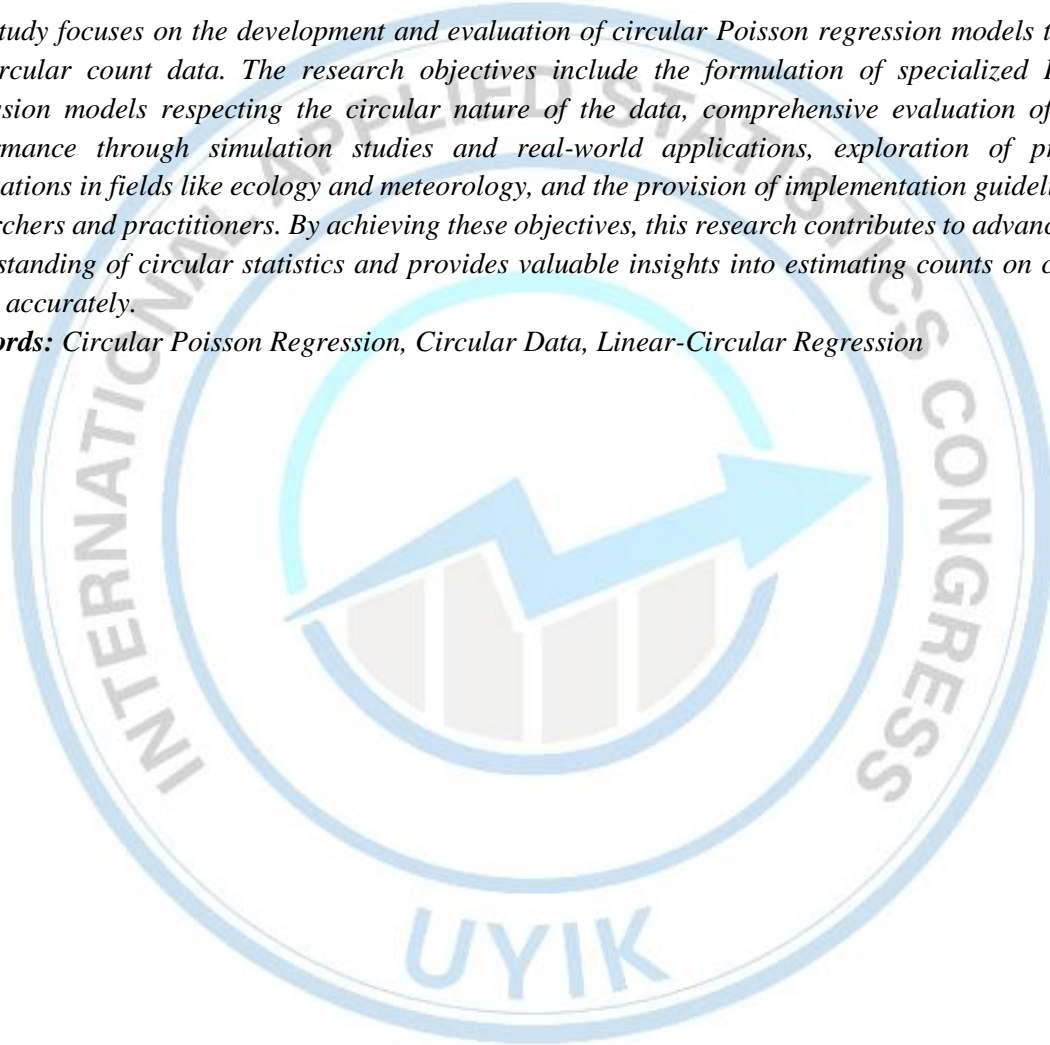
<sup>1</sup>Western Illinois University, Department of Mathematics and Philosophy Macomb, IL 61455

\*Corresponding author e-mail: f-tasdan@wiu.edu

### ***Abstract***

*This study focuses on the development and evaluation of circular Poisson regression models tailored for circular count data. The research objectives include the formulation of specialized Poisson regression models respecting the circular nature of the data, comprehensive evaluation of model performance through simulation studies and real-world applications, exploration of practical applications in fields like ecology and meteorology, and the provision of implementation guidelines for researchers and practitioners. By achieving these objectives, this research contributes to advancing the understanding of circular statistics and provides valuable insights into estimating counts on circular scales accurately.*

**Keywords:** *Circular Poisson Regression, Circular Data, Linear-Circular Regression*





## Modelling Climate Change Impact on Soil Loss in Tokat

**Saniye Demir<sup>1\*</sup>, Halis Şimşek<sup>2</sup>**

<sup>1</sup>Department of Soil Science, Tokat Gaziosmanpaşa University, Taşlıçiftlik, 61100, Turkey,

<sup>2</sup>Department of Agricultural & Biological Engineering, Purdue University, West Lafayette, IN, 47906,  
USA

\*Corresponding author e-mail: saniye.140100@gmail.com

### ***Abstract***

*Understanding the potential impact of climate change requires implementing effective planning strategies in hillside terrain and mountainous areas. Many studies have been carried out with erosion models in the Tokat region, much less with the WEPP model. Thus, keeping this in view, the study aims to estimate the possible impact of projected climate change scenarios on soil loss and erosion vulnerability using the Statistical Downscaling Model (SDSM), MarkSim Weather Generator, and Water Erosion Prediction Project (WEPP) model. The present study downscaled four climate scenarios on the near future, noted the 2020 s (2010), mid-future, 2035 s, and 2065, far-future, and 2095 s under GFDL-CM3 with four Representative Concentration Pathway (RCP), 2.5, 4.5, 6.5 and 8.5 scenarios. Both GFDL-CM3 and RCP scenarios predicted an increase in temperature and annual rainfall depth during the 21st century. The calibrated WEPP model was used to simulate future soil loss. The findings of the study showed a possibility for climate change to increase the rate of soil loss unless conservation strategies or proper land use plans are implemented.*

**Keywords:** WEPP, Soil erosion, Tokat, Calibration

## Robust Regression Analysis of CO<sub>2</sub> Emission Dataset for Turkey

Elgiz Askeroğlu<sup>1\*</sup>, Fatma Zehra Doğru<sup>2</sup>

<sup>1</sup> Giresun University, Institute of Science, Department of Statistics, Giresun, Türkiye

<sup>2</sup>Giresun University, Faculty of Arts And Sciences, Department of Statistics, Giresun, Türkiye

<sup>1\*</sup>Corresponding author e-mail: elgiz\_askeroglu@hotmail.cm

### *Abstract*

*While the Industrial Revolution reduced the number of people working in the industry, it increased people's prosperity, products, and technology. However, despite all the positive effects of the Industrial Revolution, its negative aspects are being discussed by scientists. One of the negative effects is the emission of carbon dioxide (CO<sub>2</sub>). The goal of this study is to investigate the impact of industrialization on CO<sub>2</sub> emission in Turkey during the period 1973-2021 by employing robust regression and classical regression methods. To apply the regression method, CO<sub>2</sub> emission per capita is chosen as the dependent variable, while independent variables include energy consumption per capita, carbon footprint, the percentage of GDP contributed by sectors one, two, and three, oil consumption per capita, and gross domestic product. Regression estimation methods are applied using the CO<sub>2</sub> emission dataset, with a model comparison based on mean squared error. Furthermore, the study examines regression assumptions such as heteroscedasticity, normality, autocorrelation, and multicollinearity. If multicollinearity is detected, model selection methods are applied to eliminate unnecessary variables. Following variable elimination, all regression estimation methods are reapplied to identify the optimal model for the carbon emission dataset. Additionally, autocorrelation and heteroscedasticity are addressed and rectified if identified. Through this comprehensive analysis, the study aims to provide insights into the relationship between industrialization and CO<sub>2</sub> emission in Turkey over the specified period.*

**Keywords:** CO<sub>2</sub> Emission, Robust Regression, Generalized Least Squares Regression, Least Squares Regression.

**Süt Sığırlarında Panel Veri Analizi ile Laktasyon Eğrilerinin Modellenmesi**

**Emine Berberoğlu<sup>1\*</sup>, Şenay Sarıca**

<sup>1</sup>Tokat Gaziosmanpaşa University, Faculty of Agriculture, Department of Animal Science, 60250,  
Tokat, Türkiye

\*Sorumlu yazar e-mail: emine.berberoglu@gop.edu.tr

**Özet**

*İneğin süt veriminin değerlendirilmesinde laktasyon veya 305 günlük süt veriminin yanında laktasyon eğrisinin şekli, ele alınan önemli bir bilgidir. Laktasyon eğrisini tahminlemede kullanılan modellere alternatif olarak zaman serisi modelleri de kullanılmaktadır. Bazı araştırmacılar Box Jenkins yöntemlerini denetim günü kayıtlarını tanımlayan seriye kolayca uygulamışlardır. Böylece zaman serisi modeli her bir ineğin mevcut birkaç denetim günü kayıtları ile güncel laktasyonunu tahmin etmede kullanılmıştır. Ekonometrik analizlerde herhangi bir konuda hem zamana göre hem de birimlere göre analiz yapılması gerektiğinde, genellikle bu analizler zamana ve birime göre ayrı ayrı yapılmaktadır. Zamana göre yapılan analizler zaman serileri analizi olmakta, birimlere göre yapılan analizler ise yatay kesit analizi olmaktadır. Zaman serileri ve yatay kesit analizinin birleştirilmesini ve uygun modellerin test edilmesini sağlayan yöntem panel veri analizi denilmektedir. Bu çalışmada, zamana ve laktasyon sırasına göre panel veri analizi ile laktasyon eğrileri tahminlenmiştir.*

**Anahtar Kelimeler:** Laktasyon Eğrisi, Panel Veri Analizi, Süt Verimi, Modelleme



**Long-Term Analysis of Sunspot Cycles with Markov Chain Modeling**

**Danish Hassan Hassan<sup>1\*</sup>**

<sup>1</sup>Department of Applied Sciences, National Textile University Karachi Campus, Pakistan

\*Corresponding author e-mail: danishhassan@ntu.edu.pk

***Abstract***

*Study of sunspot cycles has been the exclusive topic for space scientists to understand the long term behavior of weather of space. All other influential activities of sun like solar flares, solar flux, solar irradiance and Coronal Mass Ejection are connected with the sunspot activity. The aim of research work was to apply the first order Markov chain process on each cycle of sunspots including complete time series data from 1754 to 2014. Using the Markov process the transition matrix (stochastic matrix) for each sunspot cycle is obtained. For this purpose, four states were selected according to the range of sunspots time series monthly data. The entire probability matrix shows the transition probability between the states. Many sunspot cycles indicated the maximum probability in the diagonal of transition matrix and some sunspot cycles demonstrated partially. The return periods for sunspots transition between the states were calculated. The study may be helpful to recognize the variation in sunspot cycles by the transition matrices. The obtained return periods also be useful to study the behavior of future sunspot.*

**Keywords:** Sunspot cycles, First order Markov chain, Transition Matrix, Return period.

## Cereal Crop Planting Trends and Price Dynamics: Insights from Turkey

**Mehrshad Radmehr**<sup>1\*</sup>

<sup>1</sup>Cyprus International University

\*Corresponding author e-mail: mradmehr@ciu.edu.tr

### **Abstract**

*Many countries, including Turkey have experienced a persistent increasing price level, particularly food prices. This research explores the determinants of food price escalation with a specific emphasis on Turkey's agricultural landscape, land utilization practices, and consumer price dynamics. Despite Turkey's increased production of barley and sunflower relative to wheat since 2021, wheat sowing has experienced a notable decline, posing challenges for domestic wheat supply chains. This trend is particularly significant considering the Turkish population's heavy reliance on wheat-based products. Moreover, the reduction in wheat sowing, despite its significance in Turkish cuisine, underscores challenges in meeting domestic demand. The reliance on wheat imports, primarily from Ukraine and Russia, reduced self-sufficiency in wheat production by 15% between 2021 to 2022. This inflation in food price highlights vulnerabilities exacerbated by geopolitical instability. Furthermore, the analysis highlights the implications of underutilized land on crop yields and subsequent consumer price dynamics. By assessing the degree of land underutilization and its effect on crop production efficiency, the study offers insights into potential strategies to enhance agricultural productivity and mitigate food price volatility. This research underscores the importance of addressing inefficiencies in utilization of inputs and crop production to bolster food security. By examining the critical factors, policymakers can develop targeted interventions to promote sustainable agricultural development, ensure affordability and accessibility of food for all segments of the population.*

**Keywords:** Cereal Sown, Land Utilization, Food Price, Equilibrium.

**Measurement of Efficiency of Product Groups of A Retail Company Using Data Envelopment Analysis**

**Osman Nuri Çelik<sup>1\*</sup>, Gulgonul Bozoglu Batı<sup>1</sup>**

<sup>1</sup>Yalova University, Faculty of Economics and Administrative Sciences, Business Administration Department, 77100, Yalova

\*Corresponding author e-mail: n.osmancelik@gmail.com

***Abstract***

*The retail sector, which conducts the flow of goods and services from producers to consumers, holds considerable significance today due to the increasing customer volume. The intensification of competition and technological advancements have compelled businesses to efficiently process production inputs to achieve their goals of increasing survival periods and profit margins. Additionally, ensuring the loyalty and satisfaction of existing customers, attracting potential customers, establishing brand image, and maintaining high product and service quality have become increasingly important with the prominence of customer-oriented retailing. Consequently, businesses are inclined to utilize and develop mathematical methods to track the entire process from input to output formation. In this context, this study focuses on a company that has been a leader in the international retail sector for years, where effective and ineffective decision-making units are first homogenized using Cluster Analysis method and then effectiveness identified using Data Envelopment Analysis. The aim is to examine, improve, and enhance the efficiency of identified ineffective decision-making units. In the analysis conducted with 20 decision-making units, 6 input variables, and 1 output variable, it is determined which product models possess high efficiency and which ones fail to achieve the targeted efficiency, with the underlying reasons mathematically ranked.*

**Keywords:** Key words: Retail, Efficiency, Productivity, Cluster Analysis, Data Envelopment Analysis



## Application of Ensemble Methods for Financial Time Series Forecasting

Cansu Gelmedi Posacı<sup>1\*</sup>, İdil Yavuz<sup>2</sup>

<sup>1</sup>Dokuz Eylül University, Graduate School of Natural and Applied Sciences, Statistics,  
35390, Izmir, Turkey

<sup>2</sup>Dokuz Eylül University, Department of Statistics, 35390, Izmir, Turkey

\*Corresponding author e-mail: cansugelmedi@gmail.com

### *Abstract*

*Time series data consists of data points that are measured or observed over a specified time interval. When analyzing this type of data, various components such as patterns, trends, seasonal variations, and randomness are identified to make predictions. Time series analysis is employed in various fields including finance, economics, business, marketing, meteorology, climate science, energy research and social science. In the finance sector, time series are particularly analyzed to make short-term and long-term forecasts. Predicting a company's stock or the value of a commodity is frequently needed. Similar to other learning settings, also in time series forecasting, ensemble methods like bagging (Bootstrap Aggregating) and boosting are utilized to enhance the accuracy and reliability of predictions. In this study, we investigated the impact of resampling-based approaches on the performance of forecasting financial time series. We analysed data for 10 different stocks collected for a period of 2 years. We compared the performance of Simple Exponential Smoothing and Holt's Linear model with their respective resampling-based bagged counterparts. Performance metrics such as symmetric mean absolute percentage error (sMAPE), mean absolute percentage error (MAPE), and mean absolute scaled error (MASE) were employed to evaluate the models. Our findings show that resampling based ensemble approaches provide significant improvement of forecast accuracy for both short and long term horizons for the chosen stocks.*

**Keywords:** *Bootstrap Aggregation, Simple Exponential Smoothing, Holt's Linear Model, Forecast,*

**Different Estimation Methods in Multinomial Logistic Regression**

**Ekrem Bozbey<sup>1\*</sup>, Nurkut Nuray Urgan<sup>2</sup>**

<sup>1</sup>Tekirdag BILSEM(Art and Science Center), Department of Mathematics, 59100, Tekirdag, Türkiye

<sup>2</sup>Namık Kemal University, Faculty of Art and Science, Department of Mathematics, 59030, Tekirdag, Türkiye

\*Corresponding author e-mail: krmbzby@gmail.com

***Abstract***

*Logistic regression analysis is a type of regression in which a categorical response variable is estimated with the help of one or more explanatory variables. Explanatory variables can be continuous, discrete, or a mixture of these. Logistic regression analysis is frequently used in classification problems as a supervised machine learning method. "Binary (two-category) logistic regression" analysis is applied to data where the response variable has two categories, and "Multinomial (multi-category) logistic regression" analysis is applied to data with three or more categories. Response variables can be nominal or ordinal. In this study, in the Multinomial Logistic Regression analysis performed on two different real data sets, the correlations between the explanatory variables were examined and the prediction accuracy rates of the models established with Maximum likelihood, Ridge, Lasso, Elastic net and Principal component analysis (PCA) methods were compared for each data set. Additionally, the performances of 5 different models were compared when the  $N/p$  ratio was reduced in a controlled manner ( $N$ : Number of observations,  $p$ : Number of explanatory variables) with random samples taken from each data set.*

**Keywords:** *Multinomial logistic regression, Ridge, Lasso, Elastic net, Principal components analysis*

**Impact of Covid-19 on Annuity: Lee-carter and Temporary Mortality Jump Model**

**Çiğdem Lazoğlu\*, Uğur Karabey<sup>1</sup>**

<sup>1</sup>Faculty of Science, Department of Actuarial Sciences, Hacettepe University, Ankara, 06800, Türkiye

\*Corresponding author e-mail: cigdemkobal@hacettepe.edu.tr

***Abstract***

*Mortality, a crucial factor in annuity valuation, has been scrutinized using various models in literature. However, these models often prove inadequate in unforeseen circumstances such as pandemics. Hence, temporary mortality jump models should be incorporated into mortality analyses. This study uses the commonly employed Lee-Carter model to investigate mortality. On the other hand, a temporary mortality jump model is introduced to capture the evolving mortality trends, notably observed during the COVID-19 pandemic in 2019. The comparison indicated that the temporary mortality jump model better captured the effects of the pandemic than the Lee-Carter model. Lastly, the study examines the repercussions of mortality jumps on annuity valuations. It underscores the significance of pandemic-related mortality data in ensuring accurate and risk-conscious annuity assessments.*

**Keywords:** Lee-Carter Mortality Model, Temporary Mortality Jump Model, Annuity





Estimation of Point Availability for a Repairable System under Multi-Samples

**Ömer Altındağ<sup>1\*</sup>**,

<sup>1</sup>Bilecik Şeyh Edebali University, Department of Statistics and Computer Sciences, 11230, Bilecik, Türkiye

\*Corresponding author e-mail: omer.altindag@bilecik.edu.tr

**Abstract**

Let's consider a system which can be repaired when it fails. Such systems are called as repairable systems. For repairable systems, the system may be in two different states: either it is functioning, or it is being repaired. Point availability, which corresponds to probability that the system is functioning at an arbitrary time, is an important measure of a repairable system to evaluate its functionality. Let  $X_1, X_2, \dots$  be non-negative random variables representing consecutive operating/failure times of a repairable system, and  $Y_1, Y_2, \dots$  be non-negative random variables representing consecutive repair times of the repairable system. Assume that the failure times  $X_1, X_2, \dots$  are independent and identically distributed with common distribution function  $F$ , and the repair times  $Y_1, Y_2, \dots$  are independent and identically distributed with common distribution function  $G$ . Also assume that the random variables  $X_1, X_2, \dots$  and  $Y_1, Y_2, \dots$  are mutually independent, and both  $F$  and  $G$  are continuous in  $[0, \infty)$ . Let's define point availability for an arbitrary time  $t \geq 0$  as "A(t)=Probability{The system is functioning at time t}". It is known that A(t) is the solution of the integral equation:

$$A(t) = \bar{F}(t) + \int_0^t A(t-s)dH(s), t \geq 0.$$
 Here,  $\bar{F}(t) = 1 - F(t)$ ,  $H(t) = F * G(t)$  and "\*" denotes Stieltjes convolution. The point availability can be also expressed as:

$$A(t) = \bar{F}(t) + \int_0^t F(t-s)dM(s), t \geq 0.$$
 Here,  $M(t) = \sum_{k=1}^{\infty} H^{k*}(t)$  and  $H^{k*}(t)$  is k-fold Stieltjes convolution of  $H(t)$ . When the parametric forms of  $F$  and  $G$  are completely known, the point availability  $A(t)$  can be calculated analytically or be computed numerically. However, either the forms of  $F$  and  $G$  is often unknown, or the forms are known but their parameters are unknown. In such cases, the point availability  $A(t)$  must be estimated statistically based on the samples of failure and repair times  $X_k$ 's and  $Y_k$ 's. For a repairable system, the failure and repair times of a single system are generally not sufficient. In this case, to obtain sufficient samples, it is necessary to observe the failure and repair times of multiple identical systems, which corresponds to making statistical inference from multi-samples. It should be noted that the multi-samples of failure and repair times may include both complete and censored observations. In this study, we estimate the point availability based on multi-samples of failure and repair times of a repairable system. We derive maximum likelihood estimator for  $A(t)$  and obtain its asymptotic distribution by assuming that both  $F$  and  $G$  are exponential distribution functions. We also conduct a Monte Carlo simulation to observe small sample properties of the estimator.

**Keywords:** Point availability, Multi-samples, Censored data, Maximum likelihood estimation

## Biased Estimators in the Generalized Linear Models

Merve Kandemir Çetinkaya<sup>1\*</sup>, Selahattin Kaçiranlar<sup>2</sup>

<sup>1</sup>Revenue Administration, Audit and Coordination Directorate, 06450, Ankara, Turkey

<sup>2</sup>Çukurova University, Faculty of Science and Education, Statistics, 01330, Adana, Turkey

\*Corresponding author e-mail: kandemirmerve@gmail.com

### Abstract

Generalized linear models (GLM) applications have become very popular in recent years. However, if there is a high degree of relationship between the independent variables, the problem of multicollinearity arises in these models. It is observed that the jackknifing procedure has not been applied to the TPE in GLMs so far. Therefore, the aim of this letter is to propose a new Jackknifed two-parameter estimator (JTPE) and a new modified Jackknifed two-parameter estimator (MJTPE) in the case of Poisson, negative binomial and gamma distributed response variables in order to reduce the bias and overcome the multicollinearity problem. To apply this idea, let  $s_{-i}$ ,  $Z_{-i}$  and  $W_{[-i]}$  denote respectively, the vector  $s$  with its the  $i$ th row deleted, the matrix  $Z$  with the  $i$ th row deleted, and the matrix  $W$  with the  $i$ th both row and column deleted and the JTPE is obtained by using the Sherman–Morrison Woodbury theorem. After algebraic simplifications, the MJTPE is obtained by using the JTPE. We examined bias vectors, covariance matrices and matrix mean squared error (MMSE) of the Jackknifed ridge estimator (JRE), modified Jackknifed ridge estimator (MJRE), Jackknifed Liu estimator (JLE), modified Jackknifed Liu estimator (MJLE), Jackknifed Liu-type estimator (JLTE) and modified Jackknifed Liu-type estimator (MJLTE) given in the literature. According to bias vectors and covariance matrices, the superiority of JTPE has been demonstrated theoretically. The generalization of some estimation methods for ridge and Liu parameters with the minimum simulated mean squared error (SMSE) in GLMs ggplot plots are provided. These parameters are placed into JRE, JLE, JLTE and JTPE. Our aim here is select the best parameter from biasing parameters that have been suggested numerous in the literature and is find the best jackknifed estimator by using the best parameter. Thus, we get minimum bias estimator by using biasing parameters with the minimum SMSE value. Also, the superiority of JTPE and MJTPE are assessed by the SMSE via Monte Carlo simulation study where the response follows a Poisson, negative binomial and gamma distribution with the log link function. We finally consider the benefits of new estimators by using real datasets. The purpose of the jackknife procedure is to reduce the bias, hence it is proved both theoretically and numerically that the JTPE and the MJTPE has a lower bias than that of the JRE, the JLE and JLTE. Likewise, the MJTPE has a lower bias than that of the MJRE, the MJLE and MJLTE. Moreover, some estimators of the biasing parameter  $k$  and  $d$  are proposed so that the performance of the new method becomes better than the others in terms of both SMSE and the biases values. One can always find some values of the biasing parameter so that the JTPE and the MJTPE have a lower MSE and bias.

**Keywords:** Generalized linear models, Jackknifed estimator, Multicollinearity, Two-parameter estimator, Monte Carlo

**Estimation in  $\alpha$ -Series Processes under Multiple Homogeneous Samples**

**Ömer Altındağ<sup>1\*</sup>, Mahmut Kara<sup>2\*</sup>, Halil Aydoğdu<sup>3</sup>**

<sup>1</sup>Bilecik Şeyh Edebali University, Department of Statistics and Computer Sciences, 11230, Bilecik, Türkiye

<sup>2</sup>Van Yüzüncü Yıl University, Department of Econometrics, 65080, Van, Türkiye

<sup>3</sup>Ankara University, Department of Statistics, 06100, Ankara, Türkiye

\*Corresponding author e-mail: omer.altindag@bilecik.edu.tr

**Abstract**

Counting processes are basic examples of stochastic processes modelling the number of events randomly occurred in a specified period. One of the well-known counting processes is homogenous Poisson process (HPP) in which the inter-arrival times of randomly occurred consecutive events are independent and identical exponentially distributed. For most data sets representing the inter-arrival times of certain events, the independency condition may hold but exponential distribution assumption may be restrictive. So, it can be assumed that they have a general distribution. In such a case, the counting process turns out to a renewal process (RP) in which the inter-arrival times are independent and identically distributed with a general distribution function  $F$ . The RP has been widely used in the fields of applied probability such as reliability analysis, warranty analysis, risk analysis etc. If a data set representing the inter-arrival times of consecutive events doesn't hold identically distributed feature, the non-homogenous Poisson process (NHPP), in which the inter-arrival times are neither independent nor identically distributed, may be used. The non-identical property of inter-arrival times of NHPP allows to model data sets having trend properly. However, the dependency between inter-arrival times of consecutive events may result some difficulties in modelling the data set. To overcome the difficultness of dependency, direct monotonic counting process models, in which the inter-arrival times are assumed to be independent but may be stochastically monotone, should be considered. Such processes are commonly used in stochastic modelling of repairable systems, deteriorating systems etc. An important model of monotonic counting process is  $\alpha$ -series process (ASP). Let  $X_1, X_2, \dots$  be non-negative random variables representing the inter-arrival times of consecutive events, then the process  $\{X_k, k = 1, 2, \dots\}$  said to be an ASP with trend parameter  $\alpha \in \mathbb{R}$  if the random variables  $k^\alpha X_k, k = 1, 2, \dots$  are independent and identically distributed with a general distribution function  $F$ . Estimation of trend parameter  $\alpha$  as well as other parameters such as mean and variance of  $X_k$  is of great importance. In this study, we consider parametric estimation in ASPs by assuming the inter-arrival times are exponentially distributed under multiple homogeneous samples which may yield complete and censored observations. We derive maximum likelihood estimators for the parameters of interest and investigate their statistical properties.

**Keywords:**  $\alpha$ -series process, Multi-samples, Censored data, Maximum likelihood estimation



## A Robust Approach Using M-estimation for Dynamic Panel Autoregressive Model

**Beste Hamiye Bevaztas**<sup>1\*</sup>

<sup>1</sup> Istanbul Medeniyet University, Faculty of Engineering and Natural Sciences, Department of Statistics, 34700, Istanbul, Turkey

\*Corresponding author e-mail: beste.sertdemir@medeniyet.edu.tr

### *Abstract*

*Generalized method of moments estimators used for dynamic panel models may produce biased and/or inefficient estimates when the series exhibits high persistence and/or when the variance of the individual effects differs from that of the variance of the error term. To overcome this problem, we propose a weighted M-estimator to estimate the parameters of the panel autoregressive models efficiently in the presence of high persistence. In the proposed estimator, Huber's loss function is first applied to the data to obtain the residuals, which are then used to robustly estimate the variance. Parameter estimates are updated via a weighted M-estimate where the robust variance estimates are used as weights. This step is repeated till obtaining the optimal tuning parameter with minimum variances of the estimators. Several Monte-Carlo experiments and an empirical data analysis are used to evaluate the performance of the proposed method.*

**Keywords:** Panel autoregressive models, Linear dynamic panel data, M-estimation, Generalized method of moments.

## Recent Applications of Agriculture 4.0 and Smart Farming Ecosystems

Ömer Sefa Yüksel<sup>1\*</sup>, İlker Kara, Seda Sahin<sup>3</sup>

<sup>1</sup>Msc. Student, Department of Electrical and Computer Engineering, Çankırı Karatekin University, 18100, Çankırı, Türkiye

<sup>2</sup>Assoc. Prof. Dr., Eldivan Health Services Vocational School, Çankırı Karatekin University, 18100, Çankırı, Türkiye

<sup>3</sup>Asst. Prof. Dr., Department of Computer Engineering, Çankırı Karatekin University, 18100, Çankırı, Türkiye

\*Corresponding author e-mail: o.sefayuksel@gmail.com

### *Abstract*

*The digitisation of agriculture which is called as Agriculture 4.0, has brought significant benefits while simultaneously escalating cybersecurity risks. With the rapid adoption of smart farming technologies and infrastructure, the agricultural sector has become an attractive target for cyberattacks. This is essential for protecting the agriculture sector in the era of digital transformation, ensuring the resilience and sustainability of the food supply chain against emerging cyber risks. Agriculture plays a vital role in contemporary society and is often regarded as one of the most pivotal innovations in our century. Farmers can use trend analysis to predict future weather patterns and crop harvests in the upcoming days by using Agriculture 4.0 technologies. IoT in agriculture will assist farmers in maintaining crop quality and soil fertility, hence increasing output volume and quality. The data acquired is used to leverage technological breakthroughs, allowing for better decision-making. By recording data from sensors, IoT devices will provide real-time information about the status of crops. Using predictive analytics may get information to make better harvesting decisions. In this study, the recent studies which Agriculture 4.0 and smart farming ecosystems with cybersecurity are presented and explained. The importance of this study is a general search in the field of intelligent agriculture and It supports useful information for future studies.*

**Keywords:** Agriculture 4.0, Cybersecurity, IoT applications, Smart farming

## Weibull Dağılımına Uyum İyiliği Testlerinde Parametre Tahminlerinin Etkisi

**Fatih Yılmaz<sup>1\*</sup>, Ahmet Pekkör<sup>1</sup>**

<sup>1</sup> Necmettin Erbakan Üniversitesi, Fen Fakültesi, İstatistik Bölümü, Konya, Türkiye

\*Sorumlu yazar e-mail: yilmazoglu@gmail.com

### Özet

Birçok disiplinde Weibull dağılımı ile modelleme yaygın olarak kullanılmaktadır. Uyum iyiliği testleri ve parametre tahmin yöntemleri de bu modelleme sürecinde aktif bir rol oynamaktadır. Bu çalışmada En Küçük Kareler (EKK), En Çok Olabilirlik (EÇO) ve Momentler (M) parametre tahmin yöntemleri ile literatürde sıklıkla Weibull dağılımı için kullanılan 10 uyum iyiliği testi incelenmiştir. Bu incelemelerde Monte-Carlo simülasyonundan faydalanılmıştır. Simülasyonlarda Weibull dağılımına alternatif dağılımlara göre farklı parametre tahmin yöntemleri ile farklı uyum iyiliği testlerinin güç performansları hesaplanmıştır. Güç performanslarının değerlendirilmesinde çok ölçütlü karar verme (TOPSİS) yaklaşımından yararlanılmıştır. TOPSİS yönteminin karar matrisleri, uyum iyiliği testleri ve parametre tahmin yöntemleri sırasıyla alternatifleri ve eşit ağırlıklı olarak ölçütleri oluşturmuştur. Farklı örneklem büyüklüğü ve alternatif dağılımlara göre karar matrisleri incelendiğinde parametre tahmin yöntemlerinin uyum iyiliği testlerinin performanslarına büyük ölçüde etki ettiği görülmüştür. **Anahtar Kelimeler:** Uyum iyiliği testleri, Parametre tahmini, Weibull dağılımı, Çok ölçütlü karar verme



## Survival Data Modeling for Inventory Management

**Tuğba Demircioğlu<sup>1\*</sup>, Müjgan Tez<sup>2</sup>**

<sup>1</sup>Istanbul, Türkiye

<sup>2</sup>University of Marmara, Faculty of Sciences, Department of Statistics, 34722, Isanbul, Türkiye

\*Corresponding author e-mail: tugbademircioglu@gmail.com

### ***Abstract***

*E-commerce, which has increased its influence with the digitalizing world and the pandemic, has started to be seen as a main line of business in the retail sector. One of the most effective methods of increasing the sales figures in e-commerce is the campaigns made in certain periods. Inventory management is of vital importance in the retail industry in order to respond to the high sales volumes expected during the campaign period. In this research, survival analysis methods were applied to the nine-month e-commerce sales data of a large chain market operating in the retail sector in Turkey. Between January 2022 and October 2022, each campaign limited by stocks was observed during the follow-up period determined at the beginning of the research. Variables affecting the stock depletion time and stock depletion time of the campaigned products were modeled with survival analysis methods. In this context, Kaplan-Meier, Cox proportional hazard regression method, LASSO for variable selection and random survival forests, one of the survival tree methods, which is an ensemble machine learning method, were used. The model that gives the most accurate predictions of survival was determined according to Harell's C-index, which is accepted as a common evaluation criterion in survival analysis.*

**Keywords:** *Survival analysis, Cox proportional hazards model, Machine learning, Random survival forests, Ineventory management*

## Combining Information Criterion with ROC Curve for Model Selection

Aylin Göçoğlu<sup>1\*</sup>, Neslihan Demirel<sup>2</sup>, Hamparsum Bozdoğan<sup>3</sup>

<sup>1</sup>Dokuz Eylül University, The Graduate School of Natural and Applied Sciences, Department of Statistics, 35390, Izmir, Türkiye

<sup>2</sup>Dokuz Eylül University, Faculty of Science, Department of Statistics, 35390, Izmir, Türkiye

<sup>3</sup>University of Tennessee, Department of Business Analytics and Statistics, 37996, Knoxville, Tennessee, USA

\*Corresponding author e-mail: a.gocoglu@gmail.com

### *Abstract*

*Performance metrics serve as evaluative tools for assessing the precision of a model in its classification endeavors. Nevertheless, the absence of a singular option is evident, as each performance metric accentuates distinct facets within the classification process. Therefore, the choice of metric is contingent upon the specific needs and features of the data. Model selection procedures based on information criteria offer a superior alternative to classical approaches. The use of information criteria provides a more robust and theoretically grounded framework for selecting models, taking into account both goodness of fit and model complexity, thus leading to more reliable and interpretable results. Building upon this understanding, ICOMP-ROC is introduced as a novel approach that integrates performance measures with information criteria. By combining these two essential components, ICOMP-ROC offers a comprehensive framework for evaluating model performance and complexity, thereby facilitating more informed model selection decisions. We evaluated the effectiveness of the proposed method using both a simulation study and a real dataset. To find the best method, several classification algorithms are compared by using ICOMP-ROC and other measures. The results indicate that traditional performance measures can sometimes be confusing when selecting the optimal classifier. However, ICOMP-ROC consistently and reliably identified the best classifier across all scenarios, demonstrating its accuracy in both simulation studies and real dataset.*

**Keywords:** Information complexity, ROC curve, Model selection, ICOMP-ROC

**Plsregs: An R Package for Partial Least Squares Algorithms**

**Mehmet Emin Şahin<sup>1\*</sup>, Sude Gürer<sup>2</sup>, Selay Sıla Döner<sup>1</sup>**

<sup>1</sup>Marmara University, Faculty of Sciences, Department of Statistics, 34722, Istanbul, Türkiye

\*Corresponding author e-mail: m.eminsahin5334@gmail.com

***Abstract***

*In this study, we present the development of an R package for implementing the partial least squares (PLS) method, widely recognized for its utility in dimension reduction, regression, and prediction tasks. Our package incorporates various PLS algorithms, including SIMPLS, Bidiag1, Bidiag2, and KernelPLS, enabling users to fit regression models and make predictions on response variables based on new sets of predictors. By encompassing these diverse algorithms, our package empowers practitioners to accurately and efficiently model their datasets and derive precise predictions.*

***Keywords:*** Dimension reduction, Krylov subspace, Prediction





Sıralı Küme Örneklemesinde Ortalama Tahminine Yeni Bir Yaklaşım: Alt-tahmin Ediciler

Eda Gizem Kocyiğit<sup>1\*</sup>

<sup>1</sup>Dokuz Eylül University, Faculty of Science, Department of Statistics, 35390, İzmir, Türkiye.

\*Sorumlu yazar e-mail: eda.kocyiğit@deu.edu.tr

**Özet**

*Bu çalışma, sıralı küme örnekleme (SKÖ) ile ortalama tahminine yönelik yeni bir yaklaşım sunmaktadır. Klasik ortalama tahmin ediciler, örnekleme mevcut olan yardımcı değişken bilgilerini özel olarak kullanan alt tahmin ediciler olarak yeniden oluşturulmuştur, böylece tahmin sürecinde önceden popülasyon parametresine olan ihtiyaç ortadan kaldırılmıştır. Bunun yerine, SKÖ metodolojisindeki sıralama için yalnızca yardımcı değişkene dayanan yeni alt oran tahmincileri sunulmuştur. Önerilen tahmin edicilerin etkinliğini değerlendirmek için, hata kareler ortalaması ve yan formülleri elde edilmiş ve belirli koşullar altında önerilen tahmin edicilerin hem RSS klasik ortalama tahmin edicisinden hem de oran tahmin edicisinden daha iyi performans gösterdiğini ortaya koyulmuştur. Simülasyon ve gerçek veri çalışmaları önerilen tahmin edicilerin performansının SKÖ içindeki ortalama tahmin edicilere kıyasla daha iyi olduğunu desteklemektedir. Önerilen tahmin edicilerin göreceli etkinliklerinin, değişkenler arasındaki korelasyon ve örneklenen kümelerin boyutları ile arttığını gözlemlenmiştir.*

**Anahtar Kelimeler:** Sıralı küme örnekleme, ortalama kestiricisi, yardımcı değişken, örnekleme teorisi

## Hava Yolu Şirketlerinin Finansal ve Operasyonel Durumlarının Çok Kriterli Karar Verme Yöntemleri ile Değerlendirilmesi

**Özgür Hamza Deniz<sup>1\*</sup>, Selçuk Alp<sup>2</sup>**

<sup>1</sup>Yıldız Teknik Üniversitesi, Fen Bilimleri Enstitüsü, Endüstri Mühendisliği, 34349,  
İstanbul, Türkiye

<sup>2</sup>Yıldız Teknik Üniversitesi, Fen Edebiyat Fakültesi, İstatistik Bölümü, 34220, İstanbul,  
Türkiye

\*Sorumlu yazar e-mail: ozgurhamzadeniz@gmail.com

### Özet

Ulaşım; insanları, eşyaları ve hizmetleri birbirine bağladığı gibi; toplumların gelişimi, iletişimi ve ekonomik faaliyetleri için oldukça önemlidir. Dünya genelinde milyarlarca insan her gün ulaşım sistemlerini kullanmaktadır ve yıllık yaklaşık 4,5 milyar insan hava yolu ile ulaşım sağlamaktadır. Hava taşımacılığının; küresel ticaret, turizm ve bölgesel gelişimi için önemi, hava yolu şirketlerinin geleceğini anlamayı önemli hale getirmektedir. Bu çalışmada hava yolu şirketlerinin finansal ve operasyonel performansları değerlendirilerek, seçilen hava yolu şirketleri performanslarına göre sıralanmıştır. Çalışmada değerlendirme kriterlerinin ve bu kriterlerin önem derecelerinin belirlenmesinde hava yolu şirketinde görev almakta olan 4 finans uzmanı ve 3 uçuş operasyon yöneticisinin görüşleri alınmıştır. Değerlendirme kriterlerinin önem derecelerinin hesaplanması ve hava yolu şirketlerinin performanslarının ölçülmesinde Analytical Hierarchy Process (AHP), Best Worst Method (BWM) ve Full Consistency Method (FUCOM) yöntemleri kullanılmıştır. TPOP (Technique of Precise Order Preference) yöntemi ile, bu üç farklı yöntemin sonuçları birleştirilerek tek bir sonuç elde edilmiştir. AHP yöntemi ile yapılan kriter ağırlıklandırma çalışmasında Faiz, Vergi, Amortisman, ve Kira Öncesi Kar (EBITDAR) 0,1724 kriter ağırlığı ile belirlenen 21 kriterden en çok öneme sahip kriter olurken Uçulan Ortalama Parkur Uzunluğu (Km) 0,0029 kriter ağırlığı ile en az öneme sahip kriter olmuştur. AHP yöntemi ile yapılan çalışmada en başarılı hava yolu şirketi 0,2335 tercih puanı ile Turkish Airlines, en az başarılı hava yolu şirketi ise 0,1171 tercih puanı ile Air France olmuştur. BWM yöntemi ile yapılan kriter ağırlıklandırma çalışmasında Operasyonel Kar 0,1928 kriter ağırlığı ile en çok öneme sahip kriter olurken Uçulan Ortalama Parkur Uzunluğu Km 0,0027 kriter ağırlığı ile en az öneme sahip kriter olmuştur. BWM yöntemi ile yapılan çalışmada en başarılı hava yolu şirketi 0,2202 tercih puanı ile International Airlines Group, en az başarılı hava yolu şirketi ise 0,1193 tercih puanı ile Air France olmuştur. FUCOM ile yapılan kriter ağırlıklandırma çalışmasında Faiz, Vergi, Amortisman, ve Kira Öncesi Kar (EBITDAR) 0,2182 kriter ağırlığı ile en çok öneme sahip kriter olurken Uçulan Ortalama Parkur Uzunluğu Km 0,0037 kriter ağırlığı ile en az öneme sahip kriter olmuştur. FUCOM yöntemi ile yapılan çalışmada en başarılı hava yolu şirketi 0,2380 tercih puanı ile Turkish Airlines, en az başarılı hava yolu şirketi ise 0,1200 tercih puanı ile Air France olmuştur. TPOP yöntemi ile bu üç farklı çok kriterli karar verme yöntemi sonuçlarını kullanılarak elde edilen nihai çalışmada, değerlendirilen 6 hava yolu şirketi arasından Turkish Airlines en başarılı şirket olmuştur. Turkish Airlines'ı sırası ile; Delta Airlines, International Airlines Group, Ryan Air, Lufthansa Group, Air France takip etmiştir.

**Anahtar Kelimeler:** Çok Kriterli Karar Verme, TPOP, Hava Yolu Ulaşımı

## Virtual Water and Linkage with Water Accounting

Doaa Doa<sup>1\*</sup>

<sup>1</sup>Ministry of Water Resources

\*Corresponding author e-mail: doaa\_sg\_eg@yahoo.com

### *Abstract*

*The concept of virtual water and use of the statistical methods to determine the actual amount of embedded water closely linked to water accounting practices. Water accounting involves tracking the availability, distribution, and use of water resources within a specific region or country. By integrating virtual water analysis with water accounting frameworks, researchers can gain a more comprehensive understanding of water usage patterns and resource management strategies. Virtual water assessments provide valuable insights into the hidden water embedded in the production and trade of goods and services. By quantifying the virtual water footprint of different sectors of the economy, researchers can identify water-intensive industries and assess the overall water efficiency of a country's economy. This information can then be integrated into water accounting frameworks to improve water resource management practices and inform policy decisions. Furthermore, incorporating virtual water analysis into water accounting allows for a more holistic evaluation of water sustainability and resilience. By considering both the direct water consumption within a country and the virtual water transfers associated with international trade, policymakers and stakeholders can develop more effective strategies for water conservation, allocation, and risk mitigation. In summary, linking virtual water analysis with water accounting practices enhances the understanding of water usage dynamics, facilitates informed decision-making in water resource management, and contributes to the development of sustainable water policies at the national and global levels. ENG.Doaa Mohamed PhD.Student.*

**Keywords:** virtual water, water accounting, resilience



## Zaman Pencerele Araç Rotalama Problemi: Saha Ekiplerinde Bir Uygulama

**Ahmet Yıldız<sup>1\*</sup>**, Kezban Albayrak<sup>1</sup>

<sup>1</sup>Kırıkkale Üniversitesi, Mühendislik Fakültesi, Endüstri Mühendisliği Bölümü, 71450, Kırıkkale, Türkiye

\*Sorumlu yazar e-mail: yaldizahmet@gmail.com

### Özet

Günümüzde artan rekabet sonucunda gerek hizmet sektöründe gerekse üretim sektöründe lojistik maliyetlerinin azaltılması büyük önem arz etmektedir. Bu konuda önemli bir yer tutan unsurlardan biri de dağıtım maliyetidir. Üretilen ürünün ya da hizmetin müşterilere en kısa yoldan ulaştırılması söz konusu maliyetin optimize edilmesi noktasında temel unsurlardan biridir. Bu çalışmada Telekom sektöründe faaliyet gösteren bir şirkette Araç Rotalama Probleminin bir çeşidi olan Zaman Pencerele Araç Rotalama Problemi (ZARP) ele alınmıştır. Şirketin abonelerine sunduğu geniş bir hizmet türü portföyü bulunmaktadır. En önemlileri de DSL ve Fiber altyapısında sunulan Ses ve İnternet hizmet türleridir. Yeni kurulum, nakil siparişlerine ait işler, randevulu ise müşterinin istediği zaman aralığında, randevusuz ise belirli sla süreleri içerisinde saha ekipleri tarafından tamamlanması gerekmektedir. Araç rotalama ile hem şirket maliyetleri optimize edilmiş hem de zamanında yapılan iş dolayısıyla da müşteri deneyiminin artırılması sağlanmış olacaktır. Bu çalışmada geliştirilen modelin sonuçları şirketin mevcut ekip rakamları ile kıyaslanarak modelle birlikte oluşan fayda ortaya konulmaya çalışılacaktır. Aynı zamanda da literatürde birçok çeşidi olan ve çoğu gerçek hayatta karşılaşılan problemleri çözmeyi amaçlayan Araç Rotalama Problemleri için literatüre özgün bir çalışma kazandırılması hedeflenmiştir.

**Anahtar Kelimeler:** Araç Rotalama, Zaman Pencerele Araç Rotalama, En Kısa Yol, Dağıtım, Lineer Programlama

## Measuring Innovation Performance of Brics-T Countries with Integrated Entropy and Waspas Method

Ayşe Elif Yazgan<sup>1\*</sup>

<sup>1</sup>Necmettin Erbakan University, Faculty of Applied Sciences, Finance and Banking Department, 42090, Konya, Türkiye

\*Corresponding author e-mail: aeyazgan@erbakan.edu.tr

### *Abstract*

*Today, businesses have to innovate continuously in order to exist in the market, sustain their activities and compete. At the same time, countries have to ensure social welfare and sustain economic growth. In this framework, innovation has an important role in sustaining economic growth and increasing social welfare. The Global Innovation Index, announced by the World Intellectual Property Organization, offers the opportunity to make comparisons between countries by comprehensively addressing the innovation performance of countries with a large number of criteria. Thanks to this index, countries will be able to reach a competitive level in international platforms by obtaining information about their development and innovative levels and by producing policies regarding the criteria they need to improve. Accordingly, in this study, the innovation performance of the BRICS-T countries between 2019-2023 was analyzed by using ENTROPI and WASPAS (Weighted Aggregated Sum Product Assessment) methods together among the Multi-Criteria Decision Making (MCDM) techniques and the relevant countries were ranked in terms of innovation performance according to the results of the analysis. The criteria used in the Global Innovation Index to determine innovation performance in research are institutions, human capital and research, infrastructure, market sophistication, commercial sophistication, knowledge and technology outputs and creative outputs. Data on these criteria are taken from the website of the World Intellectual Property Organization. In the study, firstly, the identified criteria were weighted by the ENTROPI method; among these criteria, it was determined that the knowledge and technology outputs criterion was the most important criterion and the institutions criterion was the least important criterion in all relevant years. Finally, the innovation performance of BRICS-T countries was analyzed based on the WASPAS method. As a result of the analysis, it was observed that China had the highest innovation performance and South Africa had the lowest innovation performance in all relevant years.*

**Keywords:** *Innovation Performance, Entropy, Waspas, MCDM, BRICS-T Countries*

## Çok Kriterli Karar Verme Yöntemleri Kullanılarak Bazı Orta Doğu Ülkelerinin Yaşam Kalitesine Göre Değerlendirilmesi

Efe Sarıbay<sup>1</sup>, Sıla Topsakal<sup>1</sup>, İlayda Arslan<sup>1\*</sup>

<sup>1</sup>Dokuz Eylül Üniversitesi, İktisadi ve İdari Bilimler Fakültesi, Ekonometri Bölümü, 35160, İzmir, Türkiye

\*Sorumlu yazar e-mail: ilayda4815@gmail.com

### Özet

Refah seviyesini belirleyen önemli bileşenlerden biri yaşam kalitesidir. Yaşam kalitesi refah düzeyi veya refaha erişim kolaylığıyla ilişkilendirilir. Bu çalışmada Orta Doğu ülkelerinin yaşam kalitesi, Çok Kriterli Karar Verme Yöntemlerinden (ÇKKV) ARAS, EDAS ve TOPSIS yöntemleri kullanılarak analiz edilmiştir. Çalışmada Orta Doğu ülkelerinin yaşam kalitesi değerlendirilirken Numbeo isimli internet sitesinin Şubat 2024 verilerinden yararlanılarak; satın alma gücü, güvenlik, sağlık, yaşam maliyeti, trafikte harcanan süre, kirlilik gibi kriterler ele alınmıştır. Çalışmada, Orta Doğu ülkelerinden Bahreyn, Birleşik Arap Emirlikleri, Filistin, Irak, İran, İsrail, Katar, Kıbrıs, Kuveyt, Lübnan, Suriye, Suudi Arabistan, Umman, Ürdün, Yemen ülkelerinin verileri kullanılmıştır. Bu çalışmadaki amaç ülkelerdeki yaşam kalitesini belirli kriterlere göre değerlendirerek, yaşam kalitesinin düşük olduğu ülkeleri tespit edip iyileştirmeye yönelik adımların atılmasını sağlayarak ülkelerin yaşam kalitesi düzeyini artırmayı amaçlamaktadır. Yapılan değerlendirme sonucunda ARAS ve TOPSIS yöntemleri kullanılarak gerçekleştirilen uygulamanın sonuçlarına göre en yüksek yaşam kalitesine sahip ülkenin Umman, EDAS yöntemine göre ise Katar olduğu tespit edilmiştir.

**Anahtar Kelimeler:** Yaşam Kalitesi, Çok Kriterli Karar Verme, ARAS, EDAS, TOPSIS



**Avrupa Ülkelerinin Temel Gıda Fiyatları Açısından Çok Boyutlu Ölçekleme Analizi ve Hiyerarşik Kümeleme Analizi Kullanılarak Karşılaştırması**

**Efe Sarıbay<sup>1</sup>, Sıla Topsakal<sup>\*</sup>, İlayda Arslan<sup>1</sup>**

<sup>1</sup> Dokuz Eylül Üniversitesi, İktisadi ve İdari Bilimler Fakültesi, Ekonometri Bölümü, 35160, İzmir, Türkiye

\*Sorumlu yazar e-mail: silatopsakal@hotmail.com

**Özet**

2000'li yılların başlarından itibaren tüm dünyada olduğu gibi Avrupa kıtası ülkelerinde de tarımsal girdi maliyetlerindeki artış, küresel iklim değişikliği, doğal afetlerin etkisi, stokçuluğun artması, savaş ve terör olayları ve daha birçok sebepten dolayı temel gıda fiyatlarındaki artış çok çarpıcı bir düzeyde gerçekleşmiştir. Bu çalışmada 45 Avrupa ülkesinin 12 temel gıda fiyatlarının 09 Mayıs 2024 tarihli verileri kullanılmıştır. Bu ülkelerin kendi aralarında temel gıda fiyatları açısından sınıflandırılması ve benzerliklerinin/farklılıklarının ortaya konulması amaçlanmıştır. Ayrıca temel gıda ürünlerinin de kendi aralarında sınıflandırılması ve benzerliklerinin/farklılıklarının ortaya konulması amaçlanmıştır. Çok değişkenli istatistiksel analiz tekniklerinden Çok Boyutlu Ölçekleme Analizi ve Hiyerarşik Kümeleme Analizi kullanılarak verilerin analizi gerçekleştirilmiştir. Bu analizlerin sonucunda birbirine benzer ekonomik yapıya sahip olan, benzer coğrafi konuma sahip ülkelerdeki temel gıda fiyatlarının da birbirine yakın olduğu sonucu görülmüştür. Temel gıdalar bakımından karşılaştırma yapıldığında ise hayvansal gıdaların bir araya gelerek küme oluşturduğu ve diğer temel gıdalardan ayrıştığı görülmüştür.

**Anahtar Kelimeler:** Gıda Fiyatları, Çok Boyutlu Ölçekleme Analizi, Hiyerarşik Kümeleme Analizi

## Evaluation of Food Dryer Selection Criteria Using the Analytic Hierarchy Process

Abdurrahman Yıldız<sup>1\*</sup>

<sup>1</sup>Kütahya Dumlupınar University, Engineering Faculty, Industrial Engineering Department, 43100,  
Kütahya, Türkiye

\*Corresponding author e-mail: abdurrahman.yildiz@dpu.edu.tr

### **Abstract**

*Drying of foods such as vegetables and fruits is a preservation method used since ancient times. With this method, food can be used for a longer period of time. From previous periods until recently, the drying process was generally carried out in the form of natural drying / sun drying. In fact, this method is still one of the preferred methods due to its low cost. However, sun drying has some disadvantages due to the fact that the drying time is long, it requires the use of large areas, and since the process is generally carried out in unprotected areas, the dried product is exposed to the effects of natural creatures (insects, birds, etc.) along with pollutants such as dust etc. With the development of technology, drying machines have begun to be used, which eliminate most of these disadvantages. With the increase in production and demand, the use of drying machines is becoming widespread, and even household drying machines are produced as a micro-level use example. In this study, the criteria that can be used in the selection process for a food dryer are evaluated with the Analytic Hierarchy Process. Analytic Hierarchy Process is a Multi-Criteria Decision Making method in which criteria are compared with pairwise comparisons, taking into account the evaluations of the decision maker. At the end of the method steps, the weights of the criteria are determined. The determined weights can be used as input to the decision problem created to choose among alternatives. Criteria created for evaluation are Price (K1), Heater position (K2), Tray (Shelf) spacing (K3), Number of Trays (Shelf) (K4), Tray (Shelf) material (K5), Tray (Shelf) structure (K6), Temperature Range (K7), Timer and Automatic Shut-Off (K8), Air filter type (K9), Ease of cleaning (K10) and Noise (K11). As a result of the evaluations made with the Analytic Hierarchy Process, the criterion with the highest weight was Heater location (K2) with 21.8%, Price (K1) 18.8%, Number of Trays (Shelves) (K4) 13.3%, Trays (Shelf) spacing (K3) with 12.4% and Temperature Range (K7) with 10.1% were determined as the criteria with the highest weight. The weight of other criteria was below 10%. The determined criterion weights can be used as input in the Multi-Criteria Dryer selection problem. Additionally, other criteria may participate in the evaluation.*

**Keywords:** Multi Criteria Decision Making, Weighting Methods, Food Dryer, Analytic Hierarchy Process

**Determination of Shell Food Drying Machine Selection Criteria Weights Using the Best-Worst Method**

**Abdurrahman Yıldız**<sup>1\*</sup>

<sup>1</sup>Kütahya Dumlupınar University, Engineering Faculty, Industrial Engineering Department, 43100, Kütahya, Türkiye

\*Corresponding author e-mail: abdurrahman.yildiz@dpu.edu.tr

***Abstract***

*Rapid drying of shelled foods such as walnuts and hazelnuts is of great importance in terms of being able to supply higher quantities to the market and industry, as they provide high returns and are mostly processed as industrial products. For this reason, the traditional drying method, natural/sun drying, has begun to be replaced by drying machines due to the length of time. However, drying machines are machines that require accurate and consistent analysis during the purchasing process due to their high prices. Even though the basic working principle is the same, they are machines with different features than vegetable and fruit drying machines. They are larger in size than fruit and vegetable drying machines and are designed for mass drying of large amounts of products. In this study, the criteria that can be used in choosing a food dryer for drying shelled foods such as walnuts and hazelnuts are evaluated with the Best-Worst Method and the criterion weights are determined. This method, introduced by Rezai in 2015, allows for fewer pairwise comparisons than some other Multi-Criteria Decision Making Methods. The method is based on comparing the most important and least important criteria with other criteria. This is an approach that reduces the amount of pairwise comparisons. As a result of the method operations, the weight values of the evaluated criteria are found. The criteria to be used for evaluation are Price (K1), Capacity (K2), Energy Source (K3), Body Structure (K4), Fan Speed (K5), Resistance Power (K6), Temperature Range (K7), Mixing Function (K8), Time Setting (K9), Ease of Transport (K10). In order to apply the Best-Worst Method, Price (K1) was chosen as the most important criterion and Body Structure (K4) was chosen as the least important criterion. As a result of the application of the method, the weight values of the criteria were found. The weight values found can be used as an input for the Multi-Criteria Shell Food Dryer selection problem.*

**Keywords:** Multi Criteria Decision Making, Weighting Methods, Shell Food Drying Machine, Best-Worst Method



## Optimal Reinsurance Using Promethee Method

**Başak Bulut Karagevik**<sup>1\*</sup>

<sup>1</sup>Hacettepe University, Faculty of Science, Department of Actuarial Sciences, 06800,  
Ankara, Turkey

\*Corresponding author e-mail: basakbulut@hacettepe.edu.tr

### ***Abstract***

*Reinsurance is a strategy used by insurance companies to increase financial stability by sharing the risks they carry. However, determining the optimal reinsurance is a complex process and involves various factors. This study investigates the use of the PROMETHEE (Preference Ranking Organization Method for Enrichment Evaluations) method to determine optimal reinsurance levels, which play an important role in the risk management strategies of insurance companies. PROMETHEE is one of the multi-criteria decision-making methods for solving decision-making problems and is based on the prioritization of different criteria. The study describes how PROMETHEE can be applied to determine the level of reinsurance, taking into account the various risks faced by insurance companies as well as their financial objectives. The research results show that the PROMETHEE method is an effective tool in the process of determining the reinsurance strategies of insurance companies. This method provides a flexible integration of various criteria and offers decision-makers the possibility to evaluate and optimize different scenarios. The scope of the numerical application part, an application on insurance data using the PROMETHEE method, is examined for analyzing insurance data and evaluating the performance of various reinsurance levels*

**Keywords:** *Optimal reinsurance, multi-criteria decision analysis, PROMETHEE*

## Sigortacılık Sektöründe Müşteri Ürün Eğilim Modellemesi

İbrahim Furkan Akyüz<sup>1\*</sup>, Birsen Eygi Erdoğan<sup>1</sup>

<sup>1</sup>Marmara Üniversitesi, Fen Bilimleri Enstitüsü, İstatistik Programı, 34722, İstanbul, Türkiye

\*Sorumlu yazar e-mail: ibrahimfurkanakyuz@gmail.com

### Özet

Günümüz dünyasında değişen tüketim alışkanlıkları ile beraber müşteri hareketlerini anlamak ve pazarlama faaliyetlerine yön vermek oldukça önemli hale geldi. İşletmeler, kaynaklarında var olan müşteri verileri üzerinde doğru analizler yaparak iş verimliliklerine katkıda bulunabilirler. Bu verimlilik yöntemlerinden birisi, işletmelerin satış faaliyetleri alanına katkıda bulunması adına, müşterilerin eğilimli oldukları ürünleri bulmak adına yapılan analizler ve modellemelerdir. Bu fikirden yola çıkarak, sigortacılık sektöründen toplanan gerçek bir veri ile müşterilerin bir sigorta ürününü satın alma eğiliminde etkili olan faktörler araştırılmıştır. Toplanan veri, istatistiksel yöntemlerle analiz edilerek incelenmiş olup modelleme aşamasından önce veri ön işleme, özellik mühendisliği, özellik seçimi, veri ölçeklendirme gibi uygulamalardan geçirilerek modellemeye en uygun hale getirilmiştir. Hazırlanan veri ile makine öğrenmesi algoritmaları yardımıyla sınıflandırma modelleri denenmiş ve en başarılı algoritma ve parametre seçilerek bir sınıflandırma modeline karar verilmiştir. Bu sınıflandırma modeli, müşteri verisinin bir sigorta ürününü satın alıp almayacağını tahmin eden bir model yaklaşımına sahip olmuştur.

**Anahtar Kelimeler:** Modelleme, Eğilim, Sınıflandırma

**Comparing Forecasting Models: Sample Size Effects on Forecast Accuracy with  
Application Financial Data**

**Döne Gül Doğrusöz<sup>1\*</sup>, Esin Firuzan<sup>1</sup>**

<sup>1</sup>Dokuz Eylul University, Faculty of Sciences, Department of Statistics, 35390, Izmir

\*Corresponding author e-mail: donegulkandemir@gmail.com

***Abstract***

*Forecasting is necessary for businesses and organizations, enabling informed decision-making and risk management by leveraging historical data patterns to predict future trends. In the time series data, where accuracy is important, researchers prioritize precision and reliability in their forecasting attempt. To address this concern, our study focuses on the dynamic impact of sample size on forecast accuracy. We applied ARIMA and ETS models, which are traditional statistical methods, to the BIST100 closing data between 03.01.2022 and 29.12.2023 with incremental increases in the sample size. Dataset divided into training and testing subsets. For each data set, unit root tests for stationarity control, Levene test for variance homogeneity and normality tests were performed. When heterogeneity assumption does not satisfied, transformations were applied to ensure homogeneity before estimation. Reviewing the results, as the sample size increases, ARIMA and ETS methods may yield different outcomes. Methods may give inconsistent results depending on anomalies or breaks in the series or outlier observations.*

**Keywords:** *Time Series Analysis, Forecasting Accuracy, Financial Data, Data Size Importance*



**The Effect of Interspecific Hybrid Eggplant Rootstocks on Early Yield**

**Sevtap Doksöz Boncukcu<sup>1\*</sup>**

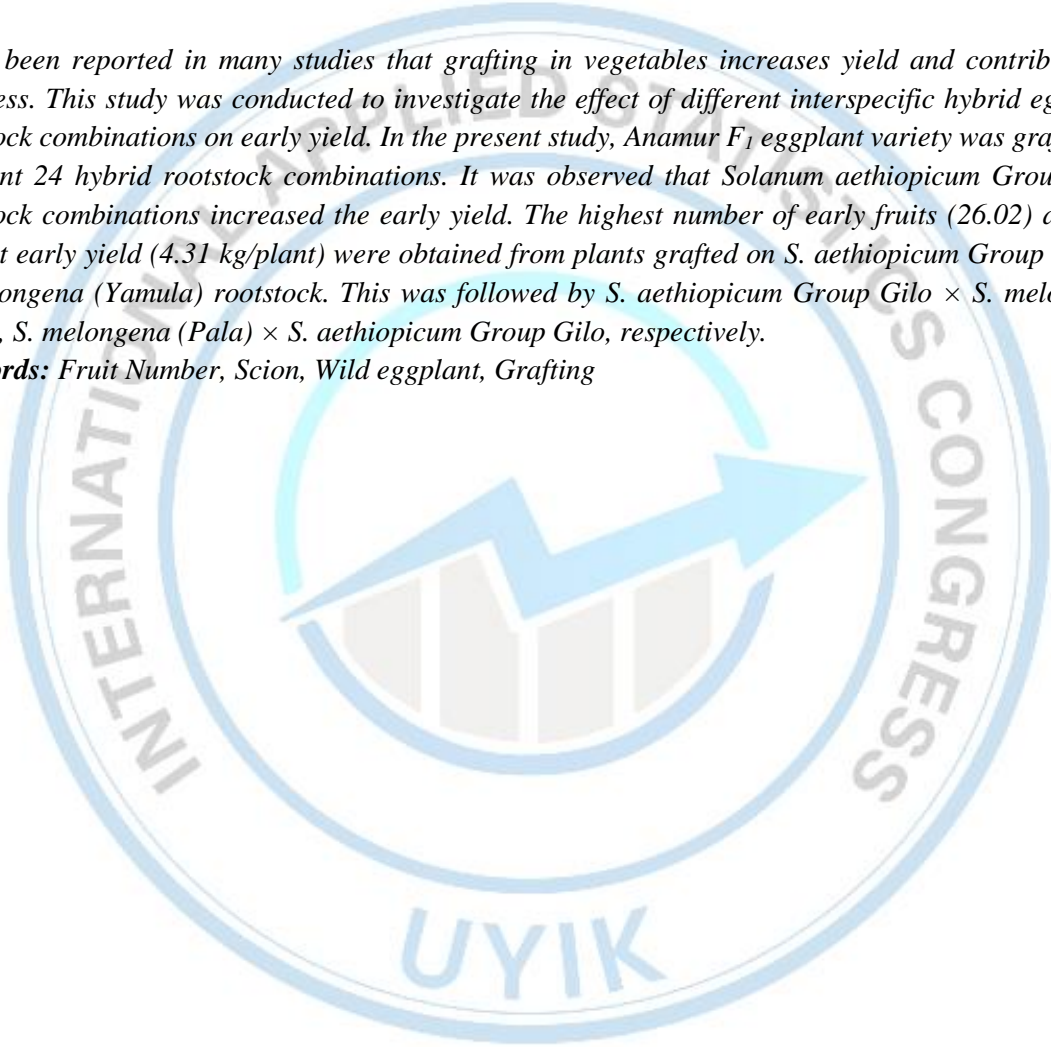
<sup>1</sup>Tokat Gaziosmanpasa University, Faculty of Agricultural, Horticulture Department, 60250, Tokat, Türkiye

\*Corresponding author e-mail: sevtap.doksoz@gop.edu.tr

***Abstract***

*It has been reported in many studies that grafting in vegetables increases yield and contributes to earliness. This study was conducted to investigate the effect of different interspecific hybrid eggplant rootstock combinations on early yield. In the present study, Anamur F<sub>1</sub> eggplant variety was grafted on different 24 hybrid rootstock combinations. It was observed that Solanum aethiopicum Group Gilo rootstock combinations increased the early yield. The highest number of early fruits (26.02) and the highest early yield (4.31 kg/plant) were obtained from plants grafted on S. aethiopicum Group Gilo × S. melongena (Yamula) rootstock. This was followed by S. aethiopicum Group Gilo × S. melongena (Pala), S. melongena (Pala) × S. aethiopicum Group Gilo, respectively.*

**Keywords:** Fruit Number, Scion, Wild eggplant, Grafting



**Simultaneous Selection for Early Maturity and High Yield in Advanced Sesame Lines**

**Hossein Zeinalzadeh-Tabrizi<sup>1\*</sup>, Sadollah Mansouri<sup>2</sup>**

<sup>1</sup>Kyrgyz-Turkish Manas University, Faculty of Agriculture, Department of Horticulture and Agronomy, 720038, Bishkek, Kyrgyzstan

<sup>2</sup>Agricultural Research, Education and Extension Organization (AREEO), Seed and Plant Improvement Institute (SPII), Department of Oilseed Crops, 31585-4119, Karaj, Iran

\*Corresponding author e-mail: h.zeynelzade@manas.edu.kg

***Abstract***

*The ongoing efforts of sesame breeders to select early-mature and high-yielding inbred lines play a crucial role in advancing sesame cultivation in Iran. These improved varieties offer benefits such as shorter growing seasons, increased yields, and reduced environmental impact, ultimately supporting the sustainable development of sesame farming and enhancing the livelihoods of farmers. 13 advanced inbred lines and a check variety (Oltan) were studied to identify early-mature and high-yielding inbred lines simultaneously in completely randomized block design trials with three replications at Karaj, Moghan, and Mashhad locations during cropping years 2016–2017. Two traits, including growth period and seed yield, were determined as criteria for the selection of genotypes. GGE biplot analysis of sesame genotypes showed that the first two components explained 92.4% of the total variations of these two traits. Based on specific GGE biplots for each location, lines G8, G6, and G1 with the least growth period and higher seed yield were identified. These findings can significantly contribute to the development of improved sesame cultivars that meet the demands of Iranian farmers and enhance the productivity and profitability of sesame production.*

**Keywords:** Concurrent selection, earliness, GGE biplot, sesame, yield

**Determination of the Effects of Different GA<sub>3</sub> and Micronutrient Combinations on Gerbera Plant Growth and Development**

**Onur Sefa Alkac<sup>1\*</sup>, Muhammed Esad Tuncel<sup>1</sup>**

<sup>1</sup>Tokat Gaziosmanpasa University, Faculty of Agriculture, Department of Horticulture, 60250, Tokat, Türkiye

\*Corresponding author e-mail: onur.alkac@gop.edu.tr

**Abstract**

*Gerbera is one of the world's leading flowers in the flower industry as a cut flower and potted plant and is among the top five cut flowers in the world. Therefore, increasing the quality and yield of this species is important. This study aimed to determine the best GA<sub>3</sub> and micronutrient concentration for gerbera cultivation by applying different levels of GA<sub>3</sub> and micronutrients to gerbera leaves and stems. The study tested 17 different GA<sub>3</sub> and micronutrient combinations in two growing seasons (two years). Flower stem length (cm), flower stem thickness (mm), flower diameter (mm), plant height (cm), branch weight (g), spad, root length (cm), root wet weight (g), yield (number of plants), number of tillering (number of plants) and vase life (days) parameters were analyzed. Variance analyses and Duncan tests ( $p < 0.05$ ) of the parameters examined in the study were performed in the SPSS 26.0 statistical package program. In this study carried out in two growing seasons, similar results were recorded in flower stem length, flower stem thickness, flower diameter, and flower stem length values ranged between 39.82-54.66 cm, flower stem thickness 3.46-7.25 mm, and flower diameter 89.07-112.37 mm, regardless of the growing season. Plant height and SPAD values ranged between 41.92-57.00 cm, 42.07-58.70 cm, and 13.16-21.15 g, respectively, in the 2nd growing season. Root length data ranged between 22.17-29.50 cm, root wet weight 23.75-48.20 g, and yield 1-10.33 pieces. Tillering number ranged between 24.33-49.00, and vase life ranged between 9.13-13.60 days. The combination of GA<sub>3</sub> and micronutrient applications generally increased flower quality and yield. In determining the most appropriate concentrations, it is recommended in this study to start with low concentrations at the beginning and to increase GA<sub>3</sub> and micronutrient ratios as the plant grows and develops.*

**Keywords:** *Gerbera jamesonii, Plant Growth Regulator, Gibberellic Acid, Yield, Quality*



**The Physiological Mechanism of Salinity Stress in Four Tall Fescue Cultivars**

**Shiva Sadighfard<sup>1\*</sup>, Gürkan Demirkol<sup>1</sup>**

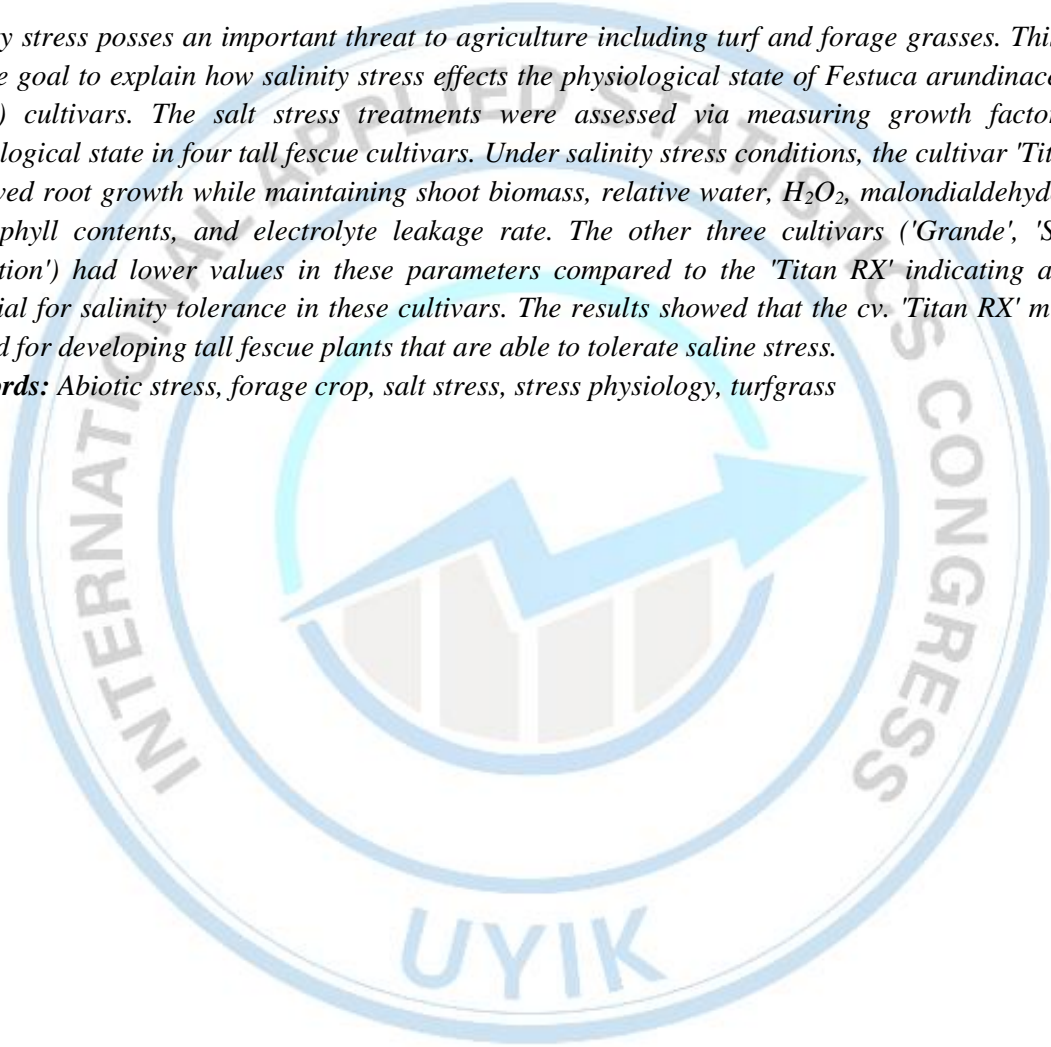
<sup>1</sup>Tokat Gaziosmanpaşa University, Department of Field Crops, 60240, Tokat, Türkiye

\*Corresponding author e-mail: shiva.sadighfard@gop.edu.tr

***Abstract***

*Salinity stress poses an important threat to agriculture including turf and forage grasses. This study has the goal to explain how salinity stress effects the physiological state of Festuca arundinacea (tall fescue) cultivars. The salt stress treatments were assessed via measuring growth factors and physiological state in four tall fescue cultivars. Under salinity stress conditions, the cultivar 'Titan RX' improved root growth while maintaining shoot biomass, relative water, H<sub>2</sub>O<sub>2</sub>, malondialdehyde, total chlorophyll contents, and electrolyte leakage rate. The other three cultivars ('Grande', 'Starlet', 'Rendition') had lower values in these parameters compared to the 'Titan RX' indicating a lower potential for salinity tolerance in these cultivars. The results showed that the cv. 'Titan RX' might be utilized for developing tall fescue plants that are able to tolerate saline stress.*

**Keywords:** Abiotic stress, forage crop, salt stress, stress physiology, turfgrass



**Determination of Plant Protection Problems of Tea Production in the Province of Rize**

**İnci Yüksek<sup>1</sup>, Dürdane Yanar<sup>1\*</sup>, Esen Oruç<sup>2</sup>, Yalçın Tahtalı<sup>3</sup>, Yusuf Yanar<sup>1</sup>**

<sup>1</sup>Tokat Gaziosmanpaşa University, Faculty of Agriculture, Department of Plant Protection, 60240, Tokat, Türkiye

<sup>2</sup>Tokat Gaziosmanpaşa University, Faculty of Agriculture, Department of Agricultural Economics, 60240, Tokat, Türkiye

<sup>3</sup>Tokat Gaziosmanpaşa University, Faculty of Agriculture, Department of Animal Science, 60240, Tokat, Türkiye

\*Corresponding author e-mail: [durdane.yanar@gop.edu.tr](mailto:durdane.yanar@gop.edu.tr)

**Abstract**

*Survey was conducted to determine the plant protection problems encountered during tea production, plant protection practices used to deal with these problems and approach to organic tea production by tea producers in Central, Çayeli, Pazar, and Ardeşen districts of Rize. Total of 320 farmers participated to the survey (80 farmers per district) and the questionnaire consisting of 52 questions. According to the results of the survey, it has been determined that the tea producers generally do not have an important plant protection problem, however two important pests threaten tea production in the region in recent years. One of these pests is the vampire butterfly (*Ricania simulans*), which was determined to have entered our country from Georgia. The other is the brown marmorated stink bug (*Halyomorpha halys*). Besides, it has been observed that our producers have prejudices about the transition to organic tea production and they stated that they do not want to switch to organic agriculture. It is thought that it would be beneficial to organize seminars and training programs in order to change the prejudices of tea producers about organic farming.*

**Keywords:** Plant protection issues, Questionnaire, Tea, Rize, Organic farming

**Kuşburnu (*Rosa Canina*) Bitkisinin Aşı ile Çoğaltılmasında İklimlendirme Süresinin Fidan Gelişimine Etkileri**

**Adil Koray Yıldız<sup>1\*</sup>, Aysen Koç<sup>2</sup>**

<sup>1</sup>Yozgat Bozok Üniversitesi, Kenevir Araştırmaları Enstitüsü, Yozgat, Türkiye

<sup>2</sup>Yozgat Bozok Üniversitesi, Ziraat Fakültesi, Bahçe Bitkileri Bölümü, Yozgat, Türkiye

\*Sorumlu yazar e-mail: adilkorayyildiz@gmail.com

**Özet**

*Kuşburnu (*Rosa spp.*), Rosaceae familyasına ait, çalı formunda bir bitkidir. Türkiye'de doğal olarak yayılış gösteren kuşburnu, peyzaj düzenlemelerinin yanı sıra meyvesi ile gıda endüstrisinde hammadde olarak kullanılmaktadır. Marmelat ve çayı yapılmaktadır. Ayrıca çekirdeğinden elde edilen yağ kozmetik sektöründe kullanılmaktadır. Türkiye'de ilk defa 2012 yılında tescillenen Yıldız çeşidi, dikenlerinin az olmasıyla ön plana çıkmaktadır. Bu çeşit dikensiz olması sebebiyle aşı ile çoğaltma yöntemleri için uygun bir aday olarak değerlendirilir. Aşılanan kalemlerin uygun iklimlendirme ortamlarında muhafazasının aşının tutmasına etkisi olduğu düşünülmektedir. Bu çalışma, Yıldız kuşburnu çeşidinin *Rosa multiflora* anaçları üzerine yonga göz aşısı ile aşılanması sonucunda elde edilen fidanların, iklimlendirme ortamında farklı sürelerde bekletilmeleri sonrasında gelişim performanslarını değerlendirmeyi amaçlamaktadır. Araştırmada, aşılanan kalemler %85 bağıl nem ve 25°C sıcaklıkta bir iklimlendirme odasında 0, 7, 14, 21 ve 28 gün bekletilmiş ve en iyi sonuçlar yedi gün sürede elde edilmiştir. Bu grup, %93,33 aşı tutma oranı ve %83,33 fidan yaşama oranı ile dikkat çekmiştir. Bulgular, aşı sonrası iklimlendirme süresinin Yıldız Kuşburnu çeşitlerinin çoğaltılmasında kritik bir faktör olduğunu göstermektedir ve yedi gün süreyle iklimlendirme, ideal bir süre olarak önerilmektedir.*

**Anahtar Kelimeler:** *Rosa canina*, Yıldız kuşburnu, aşı yöntemleri, iklimlendirme süresi, fidan gelişimi



**Etlik Piliçlerde Farklı Modellerle Büyüme Eğrilerinin Tahmini ve Karşılaştırılması**

**Emine Berberoğlu<sup>1\*</sup>, Şenay Sarıca**

<sup>1</sup>Tokat Gaziosmanpaşa University, Faculty of Agriculture, Department of Animal Science, 60250, Tokat, Türkiye

\*Sorumlu yazar e-mail: emine.berberoglu@gop.edu.tr

**Özet**

*Literatürdeki matematiksel hayvan büyüme modelleri doğrusal modeller şeklinde değildir. Bu fonksiyonlarda bulunan parametrelerin tahmini için farklı matematik modeller vardır. Bu matematiksel modellerdeki bilinmeyen parametrelerin tahmin edilmesi ve bu yöntemlerin uygulanması için istatistiksel programlardan yararlanılmaktadır. Doğrusal olmayan bu matematiksel büyüme modellerinde birden fazla parametre olabilmektedir. Bu ve diğer nedenlerden dolayı parametrelerin tahmin edilmesinde matematiksel sayısal işlemlerin sayısı oldukça fazladır. Bu çalışmada Gompertz modeli ve yapay sinir ağları ile büyüme eğrileri tahminlenmiştir. ve karşılaştırılmıştır. Yöntemlerin karşılaştırılmasında; belirleme katsayısı ( $R^2$ ), ortalama mutlak sapma (OMS), ortalama mutlak yüzde hata (OMYH), ve hata kareler ortalaması (HKO) istatistikleri kullanılmıştır. Elde edilen sonuçlara göre; en büyük  $R^2$  değerine sahip olan yöntemin incelenen modeller içerisinde en iyi model olduğu saptanmıştır.*

**Anahtar Kelimeler:** Gompertz modeli, Yapay sinir ağları, Broyler

**Bahçe Bitkilerinde Antosiyanin Tahmini için Makine Öğrenimi Tabanlı Geliştirilen  
Yöntemler ve Karadut Örneği**

**Osman Nuri Öcalan<sup>1\*</sup>, Onur Saraçoğlu<sup>1</sup>**

<sup>1</sup>Tokat Gaziosmanpaşa Üniversitesi, Ziraat Fakültesi, Bahçe Bitkileri Bölümü

\*Sorumlu yazar e-mail: osmannuri.ocalan@gop.edu.tr

**Özet**

*Bitkiler stres koşullarına maruz kaldığında, geri dönüşü olmayan hasarlar meydana gelebilir ve bu da verimi olumsuz yönde etkiler. Bu nedenle bitkilerde antosiyanin birikimi gibi stres belirtilerini mümkün olduğunca erken tespit etmek önemlidir. Günümüzde antosiyanin analizi, incelenen numuneyi tahrip eden invaziv yöntemler kullanılarak gerçekleştirilmektedir. Bu yöntemler aynı zamanda pahalı ve zaman alıcıdır. Bu çalışmada, bahçe bitkilerinde antosiyanin içeriğini belirlemek amacıyla daha önce denenmiş makine öğrenimi yöntemleri incelenmiş ve bir örnek olarak karadut meyvelerinde antosiyanin içeriğini belirlemek için makine öğrenimi yöntemleri uygulanmıştır. Çalışmada, farklı olgunluk düzeyinde (açık pembeden siyaha kadar) yaklaşık 872 adet meyve hasat edildikten sonra, her bir meyvenin; pH, suda çözümlü kuru madde (SÇKM), bireysel renk ( $L^*$ ,  $a^*$ ,  $b^*$ ) ve antosiyanin miktarı değerleri belirlenmiştir.  $L$ ,  $a$ ,  $b$ , SÇKM ve pH değerleri bağımsız değişken, antosiyanin içeriği ise bağımlı değişken olarak kullanılmıştır. Elde edilen veriler makine öğrenimine aktarılarak antosiyanin değerleri tahmin edilmeye çalışılmıştır. Kullanılan makine öğrenimi algoritmaları: MultilayerPerceptron (MLPNN), Sequential Minimal Optimization (SMO), K-nearestneighbor (IBk) ve RandomForest algoritmalarıdır. Geliştirilen modellerin performans değerlendirme kriterleri olarak korelasyon katsayısı ( $r$ ), ortalama mutlak hata (Mean absolute error-MAE), ortalama hata kareleri karakökü (Root Mean Square Error-RMSE), bağıl mutlak hata (Relative Absolute Error-RAE) ve bağıl hata kareleri karakökü (Root relative squared error-RRSE) kullanılmıştır. Çalışma sonucunda, antosiyanin tahmininde en başarılı algoritma RandomForest algoritması olarak belirlenmiştir.*

**Anahtar Kelimeler:** RandomForest, Yapay sinir ağı, MLPNN, SMO, IBk

**Naşı Armudu Kurutma Sürecinin Görüntü İşleme Metodu ile Analizi**

**Adil Koray Yıldız<sup>1\*</sup>, Burcu Aksüt<sup>2</sup>**

<sup>1</sup>Yozgat Bozok Üniversitesi, Kenevir Araştırmaları Enstitüsü, Yozgat, Türkiye

<sup>2</sup>Tokat Gaziosmanpaşa Üniversitesi, Ziraat Fakültesi, Yozgat, Türkiye

\*Sorumlu yazar e-mail: adilkorayyildiz@gmail.com

**Özet**

“Asya Armudu” veya “Japon Armudu” olarak da bilinen Naşı armudu (*Pyrus pyrifolia*), Asya kökenli, sulu ve tatlı bir meyvedir. Meyvelerde tüketimi genişletmek ve raf ömrünü uzatmak amacıyla kurutma işlemleri yaygın olarak kullanılmaktadır. Naşı armudu tatlı aroması nedeniyle kurutulmuş tüketilmesi tercih edilen meyvelerdendir. Bu çalışma, Naşı armudunun kurutma sürecinde meydana gelen fiziksel değişikliklerin, özellikle renk ve şekil değişimlerinin, görüntü işleme yöntemleri kullanılarak analizini detaylandırmaktadır. Kurutma işlemi sırasında, armut dilimlerinin homojen bir şekilde incelenebilmesi için, her bir dilim dairesel ve 5 mm kalınlığında kesilmiştir. Kurutma işlemi, üç farklı sıcaklıkta (50°C, 60°C, 70°C) nem tayin cihazında gerçekleştirilmiş, her bir sıcaklık için kuruma süreleri ve nem oranları kaydedilmiştir. Görüntü işleme süreci, kurutma işlemi boyunca nem tayin cihazının üzerine yerleştirilen sabit bir kamera ile yapılmıştır. Bu kamera, belirli zaman aralıklarında armut dilimlerinin görüntülerini kaydetmiştir. Alınan görüntüler, sabit ışık altında ve değişmeyen kamera ayarları ile elde edilerek görüntülerin homojenliği sağlanmıştır. Görüntüler, armut dilimlerinin kurutma süreci boyunca gösterdiği renk değişikliklerini ve şekil bozulmalarını detaylı bir şekilde kaydetmek için analiz edilmiştir. Bulgulardan elde edilen istatistik analizleri sonucunda, kurutma sürecinin başlangıcından sonuna kadar armut dilimlerindeki renk tonlarında ve genel görünümde önemli değişiklikler olduğunu anlaşılmıştır. Bu değişiklikler, kurutma sürecinin etkinliği ve kuru ürün kalitesi üzerine doğrudan etkileri açısından değerlendirilmiştir. Çalışmanın sonuçları, kurutma sürecinin armut dilimlerindeki renk ve şekil değişikliklerine olan etkisini detaylı olarak ortaya koymuştur. Bulgular, kurutma parametrelerinin optimizasyonu için önemli bilgiler sağlayarak, gıda sanayisinde kalite kontrol ve ürün standardizasyonu açısından değerli katkılarda bulunabilir. Özellikle, renk değişimleri üzerine yapılan detaylı analizler, tüketici tercihleri ve pazarlanabilirlik açısından kritik öneme sahiptir. Ayrıca, elde edilen verilerin gelecek çalışmalarda, kurutma süreçlerinin daha da iyileştirilmesi için bir temel oluşturabileceği ve farklı meyve türleri için benzer yöntemlerin uygulanabilirliğini araştırmak açısından faydalı olabileceği öngörülmektedir.

**Anahtar Kelimeler:** Görüntü İşleme, Renk değişimi, Kurutma



**Financial Connectedness Among the Sectors Listed in BİST**

**Selim Yildirim<sup>1\*</sup>, Ekrem Meriç<sup>2</sup>**

<sup>1</sup>Anadolu University, Faculty of Economics and Administrative Sciences, Department of Economics,  
26479, Eskişehir, Türkiye

<sup>2</sup>Anadolu University, Faculty of Economics and Administrative Sciences, Department of Management,  
26479, Eskişehir, Türkiye

\*Corresponding author e-mail: selimy@anadolu.edu.tr

***Abstract***

*This study examines the financial connectedness and risk transmission among Sectors as they are listed in BİST (Borsa İstanbul). In this study, connectedness is defined within the framework of network theory. Network theory studies netlike structures where nodes or vertices are connected by edges. Network theory to visualize and analyze the correlations between different assets or asset classes. This helps in identifying clusters of highly correlated assets, which might be riskier during periods of market stress. Moreover, network theory lets financial markets and institutions be modeled as interconnected networks where nodes represent entities (such as banks, firms, or countries) and edges represent financial relationships or transactions (like lending, borrowing, or trade linkages). By studying how different parts of the financial system are connected, analysts and policymakers can better predict and prevent financial instabilities that could lead to broader economic issues. Using daily data over the period from January 04, 2010 to May 29, 2024, we investigate financial connectedness among the sectors in three periods, namely pre-, during, and post-COVID19. The empirical results show a strong association between the aggregated financial movements pre-, and post-COVID-19 periods, with obvious weakening through the COVID19 period.*

**Keywords:** *Financial Connectedness, Network Analysis, Sectoral Indices in BIST*

## Spatial Analysis of Poverty in Turkey

Özlem Kiren Gürler<sup>1\*</sup>

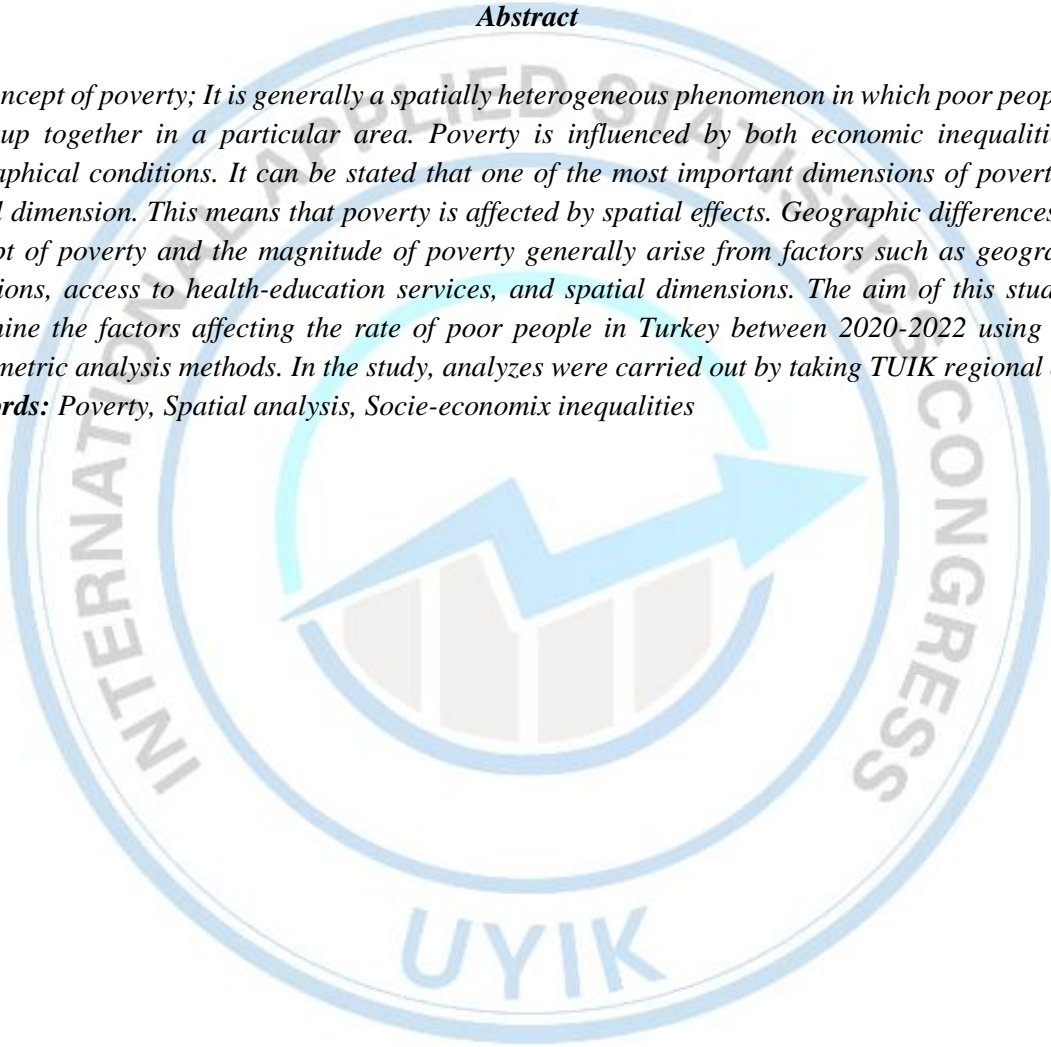
<sup>1</sup>Dokuz Eylül University, Faculty of Economics and Administrative Sciences, Department of Econometrics, 35400, İzmir, Türkiye

\*Corresponding author e-mail: ozlem.kiren@deu.edu.tr

### *Abstract*

*The concept of poverty; It is generally a spatially heterogeneous phenomenon in which poor people tend to group together in a particular area. Poverty is influenced by both economic inequalities and geographical conditions. It can be stated that one of the most important dimensions of poverty is its spatial dimension. This means that poverty is affected by spatial effects. Geographic differences in the concept of poverty and the magnitude of poverty generally arise from factors such as geographical conditions, access to health-education services, and spatial dimensions. The aim of this study is to determine the factors affecting the rate of poor people in Turkey between 2020-2022 using spatial econometric analysis methods. In the study, analyzes were carried out by taking TUIK regional data.*

**Keywords:** Poverty, Spatial analysis, Socie-economix inequalities



## A Statistical Review of Regional Disparities in the Turkish Higher Educational System

**Erkan Abdulgaffar Agaoglu<sup>1\*</sup>**

<sup>1</sup>Yalova University, Department of Industrial Engineering, Yalova, Turkey

\*Corresponding author e-mail: agaoglu\_ag@yahoo.com

### ***Abstract***

*We base the methodology of this paper upon bench marking “Economics” and “Business Administration” departments” “Economics” and “Econometrics” departments”; “Econometrics” and “Statistics” departments; and “Industrial Engineering” and “Management Engineering” departments of all universities. The study cross checks the regional attraction clusters for the above domain. All institutions of the Higher Education are categorized according to the “Public” and “Foundation” institutions of higher education, with 4-year and 2-year institutions. The model is run with entrance scores, and percentages of seats filled up by ÖSYM. “Logit and Probit” is re-run for additional independent variables belonging to regional characteristics, such as Population(X1), Turkish State Planning Organization Prosperity Index of the State(X2), the percentage of seats filled by ÖSYM(X3), and Scores of the departments as independent variables. Results indicate an increasing tendency of student preferences for populated regions, with an increasing impact for larger “Economic Prosperity Regions”, thus rendering plenty of evidence for “Regional Disparities”. The regional implications of the model give very important repercussions for Strategic Planning dilemma within the Turkish Higher Education System. Strong descriptive statistics results are encouraging, reflecting prospects for further platforms, which may include cross cultural studies with full coverage of vocational education departments. The study also depicts important repercussions of “Business Education” and “Economics Education” under two different platforms. Similar lessons have been drawn from the example of Industrial Engineering and Management Engineering through quality control charts for the two higher education groups, presented under a separate coverage. We predict the existence of plenty of regionality bottlenecks, further amplified as the competition in the higher education industry is extremely “Imperfect” due to the presence of two groups with conflicting competitive edges. Any policy orientation what-so-ever, needs to concentrate upon the dilemma of regional disparities, and take corrective actions before any long term macro-based strategy can be designated for regional development. We expect the lessons drawn up here to become a major theme for any other research intending to cover “Inventorial”, and or any macro-economic modeling attempts.*

**Keywords:** Higher Education, Business and Economics Education, Early Warning Models, Regional Planning of the Higher Education



**The State of Strategic Planning Process within Turkish Higher Educational System. An Evaluation&nbsp; of the Paradox Through Statistical Quality Control Systems**

**Erkan Abdulgaffar Agaoglu<sup>1\*</sup>**

<sup>1</sup>Yalova University, Department of Industrial Engineering, Yalova, Türkiye

\*Corresponding author e-mail: agaoglu\_ag@yahoo.com

***Abstract***

*The number of privately owned foundation universities has approached to a level of 50% within the Turkish higher educational system. The student population of these universities is estimated to approach 20% of the total university student population. By the end of 2019 total number of universities have exceeded a size of 200, with individual proportions of half count. Although the phenomenon is relatively very new and expanding on a very rapid pace, it serves as an extremely important academic learning exercise. Here we focus on lessons to be drawn from the managerial and strategic implications of these rapid developments. The study also attempts to build up a platform for future cross cultural research. We use data from the departments of “Faculties of Administrative and Economic Sciences” which are subjected to the same examination typology. Secondly, almost all universities have these faculty departments, hence missing data can be avoided. Within this perspective and back ground characteristics, this study is expected to serve as the very first of its nature in the Turkish literature of higher education. The methodology of this research process is based upon the bench marking of all Business Administration departments of the Turkish Universities, being separated as Turkish Speaking and English Speaking departments of public and foundation universities. The motive behind this full population sample will help us to initiate an inventory perspective as well as plenty of conflicting behavioral aspects of the student placement preferences, thus rendering enormous potential of retrieving policy issues. within the Turkish Higher Education System. Further strength of this study is that it would enable cross checking of the regional attraction clusters for the above domain. When repeated for all departments existing in the system, the overall setup of this prototype single full population sample module would be able to render enormous potentiel for further research in our higher education system. Firstly, we interpret data profile cited above through comprehensive Descriptive Statistics, and later through a “Chi-Square” Analysis for frequency groupings of candidate placements; further elaborated through “Logit & Probit” analysis, by the assignment of dummies to the grouping of Foundation and Public Universities. The model is run with entrance scores, and percentages of seats filled up by ÖSYM. The modeling is replicated through “Quality Control Charts” serving as a discriminating tool. The outputs we receive through the Demand-Supply patters of this modeling approach reflects the strategic planning aspects of SWOT-PEST MATRIX prperties inherited within our higher educational clusters. The study indicate that the bottlenecks exist, and such a bottleneck exists when the competition in the higher education industry is “Imperfect” due to the presence of two groups with conflicting competitive and marketing edges. Any policy orientation what-so-ever, needs to concentrate upon this dilemma, and take corrective actions before any long term macro-based strategy can be designated; for example, beyond 2023, which stays as the “100th Anniversary of the Turkish Republic”. The findings are expected to become a basic theme theme for any other research intending to cover “Inventorial”, and or any “European Union Perspective” of the Turkish Higher Educational System.*

**Keywords:** Turkish Higher Education System; Econometric Methods; Strategic Planning of the Higher Education, Early Warning Models.

## Türkiye'deki Ekonomik Büyüme Üzerine Gecikmesi Dağıtılmış Otoregresif Sınır Testi Yaklaşımı

**Sinem Geçgel Karagöl<sup>1\*</sup>, Barış Aşıkil<sup>1</sup>**

<sup>1</sup>Mimar Sinan Güzel Sanatlar Üniversitesi, Fen Edebiyat Fakültesi, İstanbul, Türkiye

\*Sorumlu yazar e-mail: sinem\_gecgel89@hotmail.com

### Özet

*Bu çalışmanın amacı, Türkiye'de 1960-2014 dönemleri arasında, ekonomik büyüme, elektrik tüketimi ve enflasyon arasındaki ilişkinin kısa ve uzun dönemdeki etkilerinin araştırılmasıdır. Genişletilmiş Dickey-Fuller (ADF) ve Phillips-Perron (PP) birim kök testlerinden faydalanılarak değişkenlerin birinci düzeyde durağan oldukları tespit edilmiştir. Böylece değişkenler üzerinde uzun dönem ilişkisinin belirlenmesi için Pesaran vd. (2001) tarafından geliştirilen Gecikmesi Dağıtılmış Otoregresif (ARDL) Model yaklaşımı yapılmıştır. Uzun dönemde ARDL sınır testi katsayılarının incelenmesinden sonra kısa dönem dinamiklerine ilişkin hata düzeltme modeline (HDM) bakılarak katsayılar üzerinden yorum yapılmıştır. Model üzerinde yapısal kırılma olup olmadığını araştırmak için CUSUM ve CUSUM Kare testleri kullanılmış ve modelde yapısal kırılma olmadığı sonucuna ulaşılmıştır. Bunun yanında, hata terimiyle ilgili varsayımların sağlanıp sağlanmadığı incelenmiştir. ARDL sınır testi yaklaşımı ile uzun dönemde Türkiye'deki enflasyon ve elektrik tüketiminin ekonomik büyümeyi olumlu veya olumsuz etkileyeceği üzerinde durulmuştur.*

**Anahtar Kelimeler:** Ekonomik Büyüme, Enflasyon, Elektrik Tüketimi, ARDL Sınır Testi, Gecikmesi Dağıtılmış Otoregresif Model.

## Time Series Forecasting with Fuzzy Long-Short Term Memory Functions

Nurefşan Kalender<sup>1</sup>, Özge Çağcağ Yolcu<sup>2\*</sup>

<sup>1</sup>Uskudar University, Graduate School of Science, Department of Computer Engineering, 34672, Istanbul, Türkiye

<sup>2</sup>Marmara University, Faculty of Science, Department of Statistics, 34722, Istanbul, Türkiye

\*Corresponding author e-mail: ozge.cagcag@marmara.edu.tr

### Abstract

*Producing accurate and reliable predictions about the future is essential for determining correct and realistic strategies and making informed decisions. Therefore, the literature on time series forecasting models represents a highly active field of study. Time series forecasting models can be categorized into two main types: probabilistic and non-probabilistic models. Probabilistic models encompass classical time series models, while non-probabilistic models can be categorized into two main groups: computational-based, which rely on various types of artificial neural networks, and fuzzy-based models. Although computational approaches based on artificial neural networks are quite successful in identifying and adapting to patterns in time series, especially non-linear ones, they do not offer an approach to uncertainty, which is the fundamental element of time series. Approaches based on fuzzy set theory offer an effective approach by considering the uncertainty inherent in time series during analysis process. Neither of these two families of prediction models requires the stringent assumptions inherent in classical probabilistic models. Prediction models based on fuzzy set theory have been developed as an analytical process for modelling the fuzzy relationships inherent in time series data. While some approaches use rule-based methods for modelling these relationships, others incorporate artificial neural networks. Fuzzy regression functions (FRFs) presented a simple and rule-free approach. In FRF, the time series is fuzzified, like other fuzzy time series approaches. What sets FRFs apart is their utilization of membership values, along with specific functions of memberships in addition to the real-valued lagged variables, as inputs in multiple linear regression models. Although this approach has some advantages, it introduces a linear model between inputs and output. However, the relationship between inputs and outputs may not always be linear. In addition, the multiple linear regression model used with the FRF approach has some strict assumptions based on residuals, and these assumptions, which make the reliability of the predictions seriously questionable when not met, are not examined in the literature. The time series forecasting model introduced in this study is designed to address the inherent uncertainty of time series data and to model non-linear relationships. Model inputs consist of memberships obtained by fuzzifying time series using fuzzy C-Means clustering method, some functions of memberships, and real-valued lagged time series. Fuzzy relationships for each fuzzy set are identified by a separate Long Short-Term Memory (LSTM) deep neural network specifically designed for each fuzzy set. These LSTMs designed for each fuzzy set are called Fuzzy Long-Short Term Memory Functions (F-LSTM-Fs). The forecasts generated by each F-LSTM-Fs are adjusted according to the membership of the corresponding time series point in the relevant fuzzy set, resulting in the final predictions. The forecasting performance of the proposed model based on F-LSTM-Fs is evaluated through its application to various real-world time series.*

**Keywords:** LSTM, Fuzzy C- Means, Nonlinear Fuzzy Relationships, Forecasting, Time Series



**Type-1 Fuzzy Svr Functions Approach Based on The Fuzzy C-medoids Clustering Algorithm for Time Series Forecasting**

**İbrahim Cimşit<sup>1</sup>, Ali Zafer Dalar<sup>2\*</sup>**

<sup>1</sup>Giresun University, Institute of Science, Department of Statistics, 28200, Giresun, Türkiye

<sup>2</sup>Giresun University, Faculty of Arts And Sciences, Department of Statistics, 28200, Giresun, Türkiye

\*Corresponding author e-mail: ali.zafer.dalar@giresun.edu.tr

***Abstract***

*This research introduces a novel method for time series forecasting that combines Type-1 Fuzzy Support Vector Regression Functions (T1FSVRFs) with the Fuzzy C-medoids (FCMdd) clustering algorithm, diverging from the commonly used Fuzzy C-means (FCM) method. Unlike FCM, which calculates cluster centers as the mean of all points, FCMdd determines centers (medoids) from actual data points within each cluster. This enhances both the robustness and the accuracy of forecasts. Our approach transforms time series data into a fuzzy series, assigning a membership degree to each data point. These degrees are then used as inputs for Support Vector Regression (SVR), which predicts target values for each cluster. The forecasts from each cluster are weighted by the membership values at respective time points to produce the final forecast. We initially expand the applicability of the Euclidean-based FCMdd by incorporating various distance metrics, exploring their impact on forecast accuracy and reliability. Preliminary results using our Type-1 Medoids Fuzzy Support Vector Regression Functions (T1MddFSVRFs) indicate improvements in model performance due to these enhancements. This study not only underscores the potential of incorporating FCMdd into forecasting models but also opens new research avenues for its application across various time series datasets.*

**Keywords:** *Time series forecasting, Fuzzy C-medoids clustering algorithm, Type-1 fuzzy functions, Distance metrics, Support vector regression.*

**A Novel Hierarchical Time Series Forecasting Model Based on Fuzzy Svr Functions**

**İbrahim Cimsit<sup>1\*</sup>, Ali Zafer Dalar<sup>2</sup>, Ufuk Yolcu<sup>3</sup>**

<sup>1</sup>Giresun University, Institute of Science, Department of Statistics, 28200, Giresun, Türkiye

<sup>2</sup>Giresun University, Faculty of Arts And Sciences, Department of Statistics, 28200, Giresun, Türkiye

<sup>3</sup>Marmara University, Faculty of Science, Department of Statistics, 34722, Istanbul, Türkiye

\*Corresponding author e-mail: ibrahimcimsit@gmail.com

***Abstract***

*Hierarchical time series structure data across multiple levels, facilitating the integration of detailed data from lower levels into upper levels for the creation of overall forecasts. There are three primary approaches used in forecasting hierarchical time series (HTS): bottom-up, top-down, and middle-out. The bottom-up approach aggregates base forecasts from the lowest level to form higher-level predictions. Conversely, the top-down approach refines top-level forecasts into detailed predictions at lower levels, while the middle-out approach adjusts predictions both upwards and downwards from a middle level. This study proposes a new approach that employs Type-1 Fuzzy Support Vector Regression Functions (T1FSVRFs) as the base model to enhance the performance of HTS forecasting. The inputs for the T1-FSVRF that will produce the base forecasts include memberships determined by Fuzzy C-Means (FCM) along with their functions, and the lagged variables of the respective level of the HTS. A number of Support Vector Regressions (SVRs) will be developed according to the determined number of fuzzy clusters, with each SVR receiving inputs from the memberships and functions of the relevant fuzzy cluster. The outputs (predictions) of each structured SVR will be weighted according to the membership values of the corresponding fuzzy cluster, transforming them into the final outputs (forecasts) of the T1FSVRFs. Base forecasts generated by the T1FSVRFs for the lowest level time series within the hierarchy will be reconciled using a bottom-up approach to achieve the final forecasts. This entire forecasting process will be tuned over validation sets to minimize errors through hyperparameters such as distance metrics, fuzziness parameter, and the number of lagged variables. The performance of the T1FSVRFs on the test set will be comparatively evaluated based on the best hyperparameter combination achieved.*

**Keywords:** Hierarchical time series, Forecasting techniques, Fuzzy C-means clustering, Distance metrics, Support vector regression, Type-1 fuzzy functions.

## Comparative Study of ARIMA Model and Deep Learning Models in Energy Demand Forecasting

Nuriye Sancar<sup>1</sup>, Sahar S. Tabrizi<sup>2,3</sup>, Nadire Çavuş<sup>4</sup>, Besir Demir<sup>5</sup>

<sup>1</sup>Department of Mathematics, Near East University, Nicosia, North Cyprus via Mersin, Türkiye

<sup>2</sup>Atolla, Diyarbakır, Türkiye

<sup>3</sup>Department of Computer Engineering, Faculty of Electrical and Computer Engineering, University of Tabriz, Tabriz, Iran

<sup>4</sup>Department of Computer Information Systems, Near East University, Nicosia, North Cyprus via Mersin, Türkiye

<sup>5</sup>Department of Electronics Engineering, Gebze Technical University, Kocaeli, Türkiye

\*Corresponding author e-mail: nuriye.sancar@neu.edu.tr

### Abstract

*This study aims to compare the forecasting capabilities of deep learning (DL) models versus traditional statistical Time-Series models for energy demand. The effectiveness of AI-driven approaches, such as the "Flex2X" system have been investigated in optimizing energy consumption in commercial buildings. Using data from existing systems and external sources like weather conditions, we compare the performance of DL models, including Long Short Term Memory (LSTM) and convolutional neural networks (CNNs) against the ARIMA model in forecasting energy demand and optimizing usage. The forecasting performances of the models used in this study were compared according to various evaluation metrics such as RMSE, MAE, and MAPE. In this study, LSTM has exhibited successful forecasting performance for energy demand among other models. The improved LSTM model will be applied to Energy Management Systems for future studies.*

**Keywords:** ARIMA, LSTM, CNNs, Energy Management System, Time series



A New Time Series Prediction Model Based on Single-valued Neutrosophic Sets

Yusuf Ağaç<sup>1\*</sup>, Ufuk Yolcu<sup>2</sup>

<sup>1</sup>Marmara University, Institute of Science and Technology, Department of Statistics, 34722, Istanbul, Türkiye

<sup>2</sup>Marmara University, Faculty of Science, Department of Statistics, 34722, Istanbul, Türkiye

\*Corresponding author e-mail: yusufagac@gmail.com

**Abstract**

*In recent years, there has been a noticeable increase in the use of fuzzy logic and fuzzy set-based approaches, artificial neural networks-based approaches, and hybrid approaches combining them. These methods have been successfully applied to time series forecasting as they do not require the stringent assumptions of probabilistic models. Approaches based on fuzzy sets generally use cluster index numbers or membership values as model inputs in addition to the real-value time series observations. Moreover, in recent studies, intuitionistic fuzzy sets and their degree of non-membership based on the degree of hesitation that arises due to their nature are used as model inputs, as well as memberships and real-time series observation values. Incorporating membership degrees, which measure the degree of belonging of observations with fuzzy sets, as well as non-membership degrees, into the model inputs, has had a beneficial impact on the predictive performance of these models. Moreover, Neutrosophic Sets (NSs) examine three membership types: truth, indeterminacy, and falsity. Therefore, NSs offer a deeper and more realistic approach to uncertainty. Also, Single-Value Neutrosophic Sets (SV-NSs), a subset of NSs, generate three types of memberships ranging between 0 and 1. This study introduces a time series prediction model that employs three types of memberships generated by SV-NSs, along with their transformations, in conjunction with real-valued time series observations as inputs. The proposed model utilizes cascaded forward neural networks (C-FFNNs) to create the functional structure that transforms inputs into outputs. A C-FFNN is built for each of the three types of memberships, and the predictions generated by each are transformed into final predictions by weighting them with their respective weights. Thus, employing different C-FFNN for truth, indeterminacy, and falsity memberships enables the modelling of both linear and non-linear Neutrosophic relationships that may exist between inputs and outputs simultaneously. The effectiveness of the proposed time series prediction model is discussed comparatively through its applications to various time series.*

**Keywords:** Single-Valued Neutrosophic Set, Cascaded Feed-Forward Neural Network, Neutrosophic Relationships, Prediction, Time Series

**A Comparative Study on Hyperparameters Optimization for Support Vector Machine  
and K-Nearest Neighbors**

**Abdullah Yalcinkaya<sup>1\*</sup>, Özlem Kaymaz<sup>1</sup>**

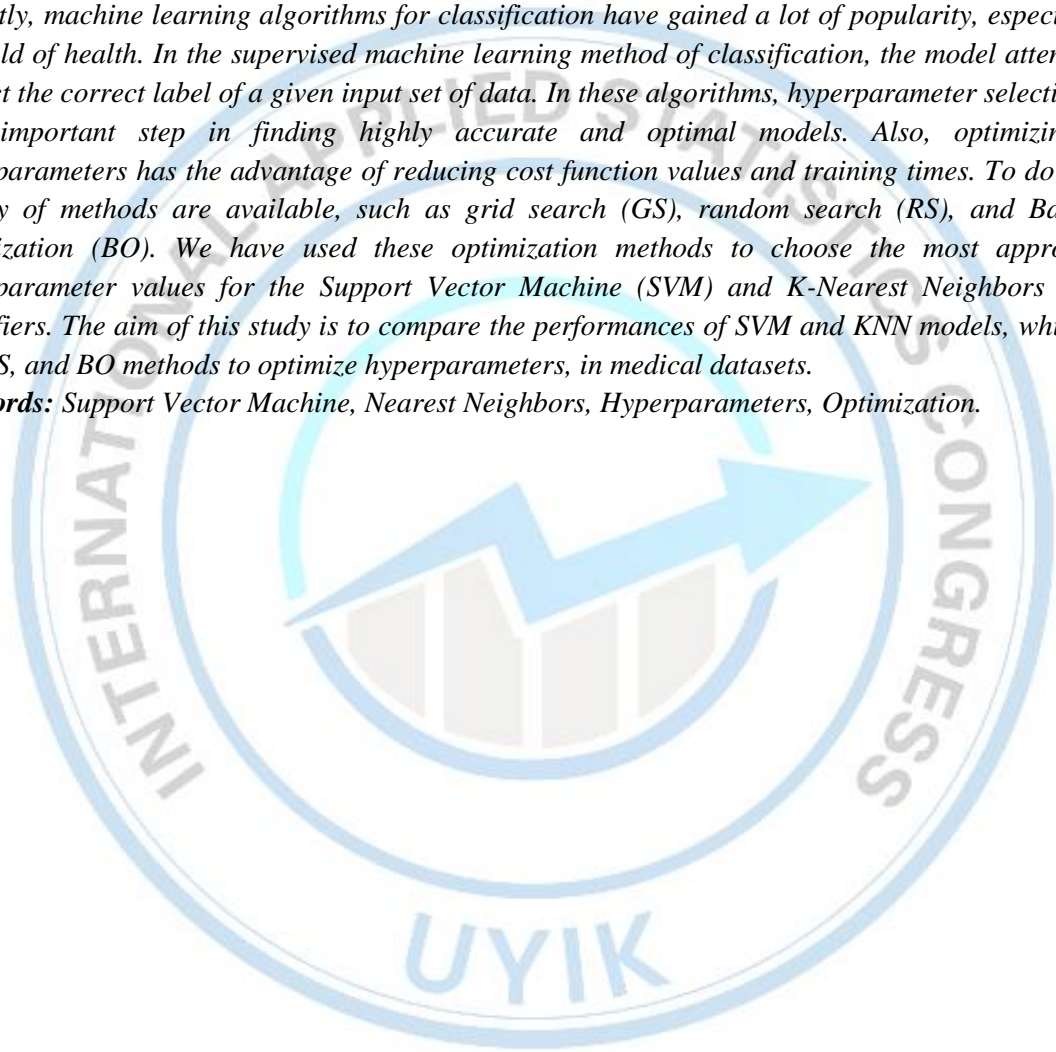
<sup>1</sup>Ankara University, Faculty of Science, Department of Statistics, 06100, Ankara, Türkiye

\*Corresponding author e-mail: ayalcinkaya@ankara.edu.tr

***Abstract***

*Recently, machine learning algorithms for classification have gained a lot of popularity, especially in the field of health. In the supervised machine learning method of classification, the model attempts to predict the correct label of a given input set of data. In these algorithms, hyperparameter selection is a very important step in finding highly accurate and optimal models. Also, optimizing the hyperparameters has the advantage of reducing cost function values and training times. To do this, a variety of methods are available, such as grid search (GS), random search (RS), and Bayesian optimization (BO). We have used these optimization methods to choose the most appropriate hyperparameter values for the Support Vector Machine (SVM) and K-Nearest Neighbors (KNN) classifiers. The aim of this study is to compare the performances of SVM and KNN models, which use GS, RS, and BO methods to optimize hyperparameters, in medical datasets.*

**Keywords:** Support Vector Machine, Nearest Neighbors, Hyperparameters, Optimization.



**Investigating the Effectiveness of Mathematics Education in Computer Engineering and Software Engineering Programs, and Its Contributions to Education and Business Life**

**Talha Ceylan<sup>1\*</sup>, Abdullah Yalçınkaya<sup>1</sup>**

<sup>1</sup> Ankara University, Faculty of Science, Department of Statistics, 06100, Ankara, Turkey

<sup>1\*</sup>Corresponding author e-mail: talhacey@gmail.com

***Abstract***

*Mathematics education provides people with skills such as analytical thinking, problem-solving, and making logical and consistent decisions, both in their education and daily lives. In the first years of the undergraduate education level of the Computer Engineering (CE) and Software Engineering (SE) programs of universities in Turkey, mathematics education is intensively provided, including courses such as Calculus, Linear Algebra, Probability and Statistics, and Differential Equations. In this study, our aim is to investigate the quality, adequacy, and necessity of mathematics education provided in CE and SE programs in Turkey, its impact on the success of students in CE and SE programs, as well as its effect on performance both in their education and professional lives. For this purpose, we have administered a survey to the students and graduates of the CE and SE programs. We have asked some questions to the participants about the success and necessity of the mathematics courses they took and the teaching performance of the instructors who taught mathematics courses. The data set obtained from the survey was organized and then analyzed using statistical methods.*

**Keywords:** *Mathematics Education, Courses, Computer Engineering, Software Engineering, Survey*



**Crime and Deterrence in Criminal Records and Statistics**

**Filiz Tepecik**<sup>1\*</sup>

<sup>1</sup>Anadolu University, Law Faculty, Economics, 26470, Eskişehir, Türkiye

\*Corresponding author e-mail: ftepecik@anadolu.edu.tr

***Abstract***

*The General Directorate of Criminal Records and Statistics registers data from the prosecutor's office and court levels of the criminal justice system. The criminal justice system process begins with the Public Prosecutor's Office and law enforcement officers becoming aware of the crime. If the prosecutor is convinced that a crime has been committed and can prove it, a public case is filed. In the next step, any criminal cases before the judge result in acquittal or conviction. This response of the criminal justice system to crime (trial and conviction) can be considered as the cost (price) of crime and constitutes the deterrence of the system. In this study, the relationship between crime and the deterrence of the criminal justice system will be examined, and data including offenses against person between 2009 and 2023, as well as economic explanatory variables, be analyzed through panel data analysis.*

**Keywords:** *Deterrence, Economic Explanatory Variables, Crimes Against Persons, Criminal Record Data.*



**Inappropriate Applications of Statistical Methods in Agricultural Research: Challenges of Violating Assumptions in Variance Analysis, Regression Analysis, and Mean Comparison Methods**

**Hossein Zeinalzadeh-Tabrizi**<sup>1\*</sup>

<sup>1</sup>Kyrgyz-Turkish Manas University, Faculty of Agriculture, Department of Horticulture and Agronomy, 720038, Bishkek, Kyrgyzstan

\*Corresponding author e-mail: h.zeynelzade@manas.edu.kg

***Abstract***

*Statistical methodologies are indispensable in agricultural research for extracting meaningful insights from data. However, several challenges arise when handling agricultural datasets, including outliers, missing data, and the adoption of inappropriate mean comparison methods. This paper delves into these challenges, discussing strategies for dealing with outliers and missing data, as well as the utilization of advanced methods such as Restricted Maximum Likelihood (REML) and Best Linear Unbiased Prediction (BLUP). Additionally, the paper addresses the repercussions of improper mean comparison methods and the importance of ensuring the normality of error distributions. Furthermore, issues related to the homogeneity of variance in experimental errors and additivity test are explored. The paper also examines techniques for data transformation to meet statistical assumptions effectively. Moreover, it emphasizes the significance of adhering to assumptions in regression analysis, such as linearity, independence of errors, homoscedasticity, and normality of residuals. Furthermore, the paper discusses the importance of detecting multicollinearity and autocorrelation in regression analysis. Additionally, this paper will also provide descriptions of software packages corresponding to these challenges. By navigating through these challenges and adopting appropriate strategies, researchers can enhance the robustness and reliability of statistical analyses in agricultural research, thus advancing knowledge and innovation in the field.*

**Keywords:** Assumption Adherence, Advanced Statistical Methods, Data Transformation, Homogeneity of Variance, Normality Assumptions

**Evaluation of Videos on Wisdom Tooth Extraction on YouTube: A Methodological Study**

**Hasan Küçükolbaşı<sup>1\*</sup>, Uğur Dolunay<sup>1</sup>, Yunus Akdoğan<sup>2</sup>**

<sup>1</sup>Selcuk University, Faculty of Dentistry, Department of Oral and Maxillofacial Surgery, 42130, Konya, Türkiye

<sup>2</sup>Selcuk University, Faculty of Science, 42150, Konya, Türkiye

\*Corresponding author e-mail: hkolbasi@gmail.com

***Abstract***

*In this study, the aim was to evaluate the content of YouTube™ videos related to wisdom tooth extraction. In March 2024, the first 60 websites obtained by searching the keyword "wisdom tooth extraction" in Turkish on YouTube™ were independently evaluated by two observers. Inclusion criteria encompassed videos being in Turkish, relevant to the subject matter, featuring verbal narration, and devoid of advertisements. During the assessment process, factors such as views, likes, dislikes, comment count, upload time, engagement index, view count, and uploader source were considered. The content analysis comprised delineating topics including the definition of third molar extraction, indications, contraindications, advantages, complications, procedure, postoperative care requirements, prognosis, and cost. Under these headings, a scoring system ranging from 0 to 9 has been implemented, with evaluations categorized into inadequate (0-3), moderate (4-6), and excellent (7-9). To evaluate interobserver agreement, the kappa score was employed, while the Kolmogorow-Smirnov test was utilized to ascertain data normality. In the data analysis, Kruskal-Wallis and Spearman correlation tests were employed, considering a significance level of  $p < 0.05$ .*

**Keywords:** Data analysis, Wisdom tooth, YouTube



**The Estimation of Seismic Hazards in Eastern Turkey and Its Surrounding Area by  
Statistical Approaches**

**Dilek Şefika Kepekçi<sup>1\*</sup>, Gulten Polat<sup>2</sup>, Fatma Figen Altınoğlu<sup>3</sup>**

<sup>1</sup>Geophysics Department Boğaziçi University, Kandilli Observatory and Earthquake Research  
Institute, 34684, İstanbul, Türkiye

<sup>2</sup>Department of Civil Engineering, Yeditepe University, 26 Ağustos Yerleşkesi, Kayışdağı Cad.  
34755, İstanbul, Türkiye

<sup>3</sup>Department of Geological Engineering, Faculty of Engineering, Pamukkale University, 20017,  
Denizli, Türkiye

\*Corresponding author e-mail: dkepekci@gmail.com

***Abstract***

*The Eastern Anatolian region of Turkey is one of the most seismically and tectonically active regions in the world. In this study, a complete set of 19933 earthquake data in the depth range from 1 to 30 km from 12 December 1905 to 30 September 2022 was collected and analysed by using the Gutenberg–Richter (GR) earthquake frequency magnitude relationship approach to determine b-value and completeness magnitude ( $M_c$ ). The size scaling b- and a-values for the overall catalogue were estimated as  $0.82 \pm 0.01$  and 5.452, respectively. The  $M_c$  for the entire investigated region was estimated to be equal to 1.9. The observed low b-values were most likely related to differential crustal stress and strain produced by large faults located in the study region. It means that the region is prone to destructive and massive earth-quakes with high magnitudes. Statistical seismic hazard analysis methods including Gutenberg-Richter Law (GR) and Generalized Poisson Regression (GPR) were also used to detect earthquake occurrence intervals and recurrence periods. The results indicated that the GPR model is consistent with the GR model for intermediate-magnitude earthquakes. However, this coherence between the models is not valid for big earthquakes ( $M_w \geq 7$ ). According to the GR and GPR models, the return period of a magnitude 7 earthquake is 106.83 and 94.0347 years, respectively. The models used in the study confirm the expected and Pazarcık and Elbistan earthquakes on 6 February, 2023 because this region had not produced a magnitude 7 earthquake since 1893.*

**Keywords:** *Seismicity, Generalized Poisson Regression Model, Generalized Negative Binomial Regression Model, b-value, Eastern Anatolia*

## Türkiye’de Yer Alan Lisanslı Güneş Panellerine İlişkin Nokta Verilerinin Mekansal İstatistiklerle Analizi

Günseli Aytac Cankurtaran<sup>1\*</sup>, Özlem Türkşen<sup>2</sup>

<sup>1</sup> Ankara Üniversitesi, Fen Bilimleri Enstitüsü, İstatistik ABD, 06100, Ankara, Türkiye

<sup>2</sup> Ankara Üniversitesi, Fen Fakültesi, İstatistik Bölümü, 06100, Ankara, Türkiye

\*Sorumlu yazar e-mail: gunseliaytac@hotmail.com

### Özet

Günümüzde enerji ihtiyacı, nüfus artışı, hızlı teknolojik gelişmeler, ekonomik büyüme ve küreselleşme gibi etkenlere bağlı olarak artmaktadır. Güneş enerjisi, enerji tüketimine cevap verebilmek amacıyla kullanılan alternatif enerji kaynaklarından biridir. Kullanımı hızla artan güneş panelleri, enerji verimliliği konusunda oldukça önemli bir yere sahiptir. Bu çalışmada, Türkiye’de yer alan güneş panellerine ilişkin nokta verilerin mekansal istatistiklerle analizi yapılmıştır. Enerji Piyasası Düzenleme Kurumu tarafından lisans verilen işletmelerin güneş panellerine ilişkin nokta verileri ve öznitelik değerleri dikkate alınmıştır. Mekansal istatistikler, güneş paneli nokta verilerine üç temel başlıkta uygulanmıştır: (i) Mekansal Betimsel İstatistikler (Mekansal Ortalama, Standart Uzaklık, Standart Sapma Elipsi), (ii) Mekansal Örüntü Analizi (Küme Analizi, En Yakın Komşuluk Yaklaşımı) ve (iii) Mekansal Otokorelasyon (Moran’ın I İndeksi, Variogram, Kriging). Mekansal istatistik analizlerinde RStudio programı kullanılmıştır. Keşfedici mekansal veri analizi ile nokta verilere ilişkin mekansal analizler yapılarak, mekansal otokorelasyon analizi ile Türkiye’de yer alan güneş panellerinin kurulu gücünün mekansal dağılımının rastgele olduğu görülmüştür. Kriging uygulanarak veri setinde yer almayan nokta verilere ilişkin kurulu güç değerleri minimum hata ile tahmin edilmeye çalışılmıştır.

**Keywords:** Mekansal nokta analizi, Mekansal betimsel istatistikler, Mekansal örüntü analizi, Mekansal otokorelasyon, Güneş paneli.

**An Dynamic Efficiency Measurement of Health Service for Turkey**

**Eda Kocak<sup>1\*</sup>, Fazıl Gökğöz<sup>2</sup>**

<sup>1</sup>Erzincan Binali Yıldırım University, Faculty of Economics and Administrative Sciences,  
Department of Management, 24100, Erzincan, Türkiye

<sup>2</sup>Ankara University, Faculty of Political Sciences, Department of Management, 06590, Ankara,  
Türkiye

\*Corresponding author e-mail: eda.kocak@erzincan.edu.tr

***Abstract***

*This paper aims to measure the efficiency of public hospitals in Turkey in 2018-2019, using Dynamic and Network Data Envelopment Analysis (DN DEA) model. Hospitals have two internal organizations: the medical-care division and administration division. The network model allows us to find both the total efficiency of hospitals and the efficiency measure of two sub-activities, which are linked by intermediate variables. Dynamic approach, on the other hand, presents the efficiency change between periods. In analysis is used input oriented VRS model. The slack-based measure approach was applied to the solution of the model. The variables of the research, namely its inputs, outputs, links and carry overs that is used to attach one year with another, were established from the variables commonly used in health efficiency. Modelling was done using Python 3.8 programming language for efficiency measurement with DN DEA. According to the results of the DN model application, in 2019 there was an increase in the average total efficiency and efficiency scores in the medical-care division and the administration division activities of hospitals compared to the previous year. Projections are presented for the ineffective hospitals to reach the efficiency of the hospitals at the effective border.*

**Keywords:** *Dynamic and network DEA, Slack-based measure, Python programming, Hospital efficiency.*



**Modelling and Prediction of Sheep Numbers in China, India and Australia Using Artificial**

**Senol Celik<sup>1\*</sup>**

<sup>1</sup>Bingöl University, Faculty of Agriculture, Department of Animal Science, Bingöl, Türkiye

\*Corresponding author e-mail: senolcelik@bingol.edu.tr

***Abstract***

*In this study, it is aimed to establish an artificial neural network (ANN) model and predict the number of sheep in China, India and Australia, which have the highest sheep populations in the world. In the study, data for the period 1961-2022 were used. In ANN development, years variable was used as input parameter and number of sheep variable was used as output parameter. Hyperbolic Tangent Function was used as activation function in ANN application. The efficiency of the developed model was determined by the statistics of Mean Square Error (MSE) and Mean Absolute Error (MAE). The ANN method that minimized the Mean Square Error (MSE) and Mean Absolute Error (MAE) values gave better results. MSE values for sheep number modelling in China, India and Australia were 17 805 950 885 523, 2 107 218 234 555 and 31 790 601 834 754, respectively, while MAE values were 3 125 535, 1 179 496 and 4 130 689, respectively. As a result of the prediction obtained by ANN, the number of sheep is expected to be 189 693 574-196 801 351 heads in China, 72 860 052-73 105 600 heads in India and 69 339 798-69 315 496 heads in Australia between 2023-2030. It is expected that the number of sheep will be in an increasing trend in China and in a fluctuating trend in India and Australia in the projected period. ANN method can be considered to be very useful in animal husbandry data.*

**Keywords:** ANN, Activation function, Sheep.

**Statistical Evaluation of Some Micro Elements (Li, Mn, Ni And Ba) Accumulated in Sediments of Turkish Straits Watersheds**

**Cem Tokatlı<sup>1\*</sup>**

<sup>1</sup>Trakya University, İpsala Vocational School, Evrenos Gazi Campus, Department of Laboratory Technology, İpsala / Edirne / Türkiye

\*Corresponding author e-mail: tokatlicem@gmail.com

***Abstract***

*Çanakkale and İstanbul Straits are known as the Turkish Straits and they are two of the most significant international marine habitats located in the north-western Türkiye. There are many fluvial and lacustrine components in the watersheds of both these straits. As many aquatic habitats, they are exposed to a significant pollution stress. This study was carried out to evaluate the lithium, manganese, nickel and barium accumulations in sediments of Çanakkale and İstanbul Straits Basins components from a statistical perspective. Eleven fluvial and four lacustrine ecosystems were defined in the watersheds and sediment samples were collected in dry and wet seasons of 2022 – 2023. Pearson Correlation Index (PCI), Principal Component Analysis (PCA) and Cluster Analysis (CA) were applied to data to categorize the investigated habitats and define the sources of investigated micro elements. According to the results of applied PCI, statistically significant positive correlations were determined among the investigated parameters. According to the results of applied PCA, two factors named as "Agricultural – Domestic factor (F1)" and "Industrial factor (F2)" explained 83% of the total variance. According to the results of applied CA, three clusters, named as "Relatively less contaminated zone (C1)", "Relatively moderate contaminated zone (C2)" and "Relatively more contaminated zone (C3)", were formed.*

**Keywords:** Çanakkale and İstanbul Straits, Micro elements, Statistical evaluation

**The Seismic Hazard Assessment of Yatağan, Turkey Using Statistical Methods**

**Fatma Figen Altınoğlu<sup>1\*</sup>, Gulden Polat<sup>2</sup>**

<sup>1</sup>Department of Geological Engineering, Faculty of Engineering, Pamukkale University, 20017,  
Denizli, Türkiye

<sup>2</sup>Department of Civil Engineering, Yeditepe University, 26 Ağustos Yerleşkesi, Kayışdağı Cad.  
34755, Istanbul, Türkiye

\*Corresponding author e-mail: faltinoglu@pau.edu.tr

***Abstract***

*Seismic hazard analysis to be conducted in a region with high seismic activity, estimating earthquake occurrence intervals and recurrence periods, are important in choosing appropriate settlements and precautions to be taken against earthquakes. Statistical methods are generally preferred for the determination of seismic hazard. Statistical methods such as Gamma, Weibull distributions, Markov, Poisson and Gumbel are a few of them. The western part of Turkey is one of the regions with high earthquake risk. Therefore, this study will contribute to revealing the possibility of exposure of the region to a devastating earthquake and to accelerate the measures to be taken against reducing the damage to the region as a result of the destructive earthquake. In this study, earthquake hazard risk analysis is conducted by taking into account instrumental records of 81366 earthquakes ( $M_d \geq 1$ ) occurred in a circular area with 150 km radius, which is centred in Yatağan (37.34° North Latitude and 28.14° East Longitude) from 1900 to 28 February 2023 taken from Boğaziçi University, Kandilli Observatory and Earthquake Research Institute, Regional Earthquake-Tsunami Monitoring Center catalogue. In order to determine earthquake hazard, Gutenberg-Richter Magnitude-Frequency Relation is calculated by using the constructed earthquake catalogue. Repetition periods of earthquakes of different magnitudes and earthquake hazard for each magnitude value were also calculated with Poisson and Gumbel Extreme Values distribution models. The results obtained from two distribution models based on different assumptions were then compared.*

**Keywords:** SW Turkey, hazard analysis, seismicity, earthquake return period, Poisson model, Gumbel model



**Spatio – Temporal Variations and Statistical Evaluation of Some Macro Elements (Na, Mg, K, Ca) in Sediments of Felent Stream (Sakarya River Basin)**

**Cem Tokatlı**<sup>1\*</sup>

<sup>1</sup>Trakya University, İpsala Vocational School, Evrenos Gazi Campus, Department of Laboratory Technology, İpsala, Edirne, Türkiye

\*Corresponding author e-mail: tokatlicem@gmail.com

***Abstract***

*Felent Stream is the most important branches of Porsuk Stream, which is one of the main fluvial watershed elements of the Sakarya River. It is being used for various purposes such as industrial water supply, irrigation water and receiving environment for domestic wastes of the Kütahya Province. This study was carried out to determine the spatio-temporal variations of sodium, magnesium, potassium and calcium accumulations in sediments of Felent Stream and to assess the sediment quality from a statistical perspective. Five locations (F1 – F5) were selected on the Felent Stream and sediment samples were collected in the dry (end of summer) and wet (end of winter) seasons of 2022 – 2023. Pearson Correlation Index (PCI) and Cluster Analysis (CA) were applied to data to categorize the investigated locations and define the significant relations among the investigated elements. The average concentrations of macro elements in sediments of Felent Stream were found in the order of Ca > Mg > K > Na and the average macro elemental content of sediments increased about four times during the wet season. As a result of applied PCI, statistically significant positive correlations were determined among the investigated parameters and as a result of applied CA, three clusters, named as "Relatively low macro elemental content zone (C1)", "Relatively moderate macro elemental content zone (C2)" and "Relatively high macro elemental content zone (C3)", were formed.*

**Keywords:** Felent Stream, Macro elements, Statistical evaluation

## Microarray Analysis of Multivariate Escherichia Coli Bacteria Datasets with R Programming

Gülşah Keklik<sup>1\*</sup>

<sup>1</sup>Istanbul Technical University, Eurasia Institute of Earth Sciences, 34469, İstanbul, Türkiye

\*Corresponding author e-mail: gulsahkeklik@gmail.com

### Abstract

*Microarray analysis, which allows scientists to understand the molecular systems underlying biological processes, is a tool developed to look at the structure and functioning of genes from a detailed perspective. Thanks to microarray technology, thousands of DNA and protein samples can be rapidly scanned simultaneously as a convenience for clinical diagnostics. In this study, multivariate datasets of Escherichia coli bacteria containing protein localisation regions from the UCI Machine Learning Repository were investigated using the microarray analysis method in R programming. With the help of `marray`, `limma` and `DAAGbio` packages used in microarray analyses in R, some information and findings such as attributes of E. coli bacteria data, spot types, surface properties and background quality control were obtained. In addition, inter-array normalisation was performed and before and after images obtained from box-whisker and correlation graphs were compared. Experimental Bayesian moderated t-statistics and Q-Q plots and volcano plots are analysed.*

**Keywords:** DNA, Escherichia coli, Microarray analysis, Protein, R programming.

**Classification of Provinces According to Trial Statistics with Cluster Analysis**

**Funda Karaman**<sup>1\*</sup>

<sup>1</sup>Hacettepe University, Faculty of Science, Department of Actuarial Science, 06800, Ankara, Türkiye

\*Corresponding author e-mail: fundakaraman@hacettepe.edu.tr

***Abstract***

*The efficiency of the judiciary in disputes arising in reputation-based relational contracts is a factor that increases confidence in the market system. In other words, a country with a properly functioning judicial system is considered to increase its ability to attract foreign investment. According to Council of Europe European Commission for the Efficiency of Justice (CEPEJ) reports, the average duration of a lawsuit private law in Türkiye is longer than rest of member states. In this study, it is tried to determine the province groups showing the same structure with the help of judicial and regional variables for 81 provinces. For this reason, it is deemed appropriate to use the method called 'Cluster Analysis'. As a result of the analysis, the worst provinces according to the judgement statistics are also identified.*

**Keywords:** Turkish private law, Cluster analysis, Court efficiency, Classification.





**Veri Zarflama Analizi ile Etkinlik Ölçümüne İstatistiksel Yöntemlerle Yaklaşım: BİST Sürdürülebilirlik Endeksi Örneği**

**Ece Nur Genç<sup>1\*</sup>, Hülya Yürekli<sup>2</sup>, Öyküm Esra Yiğit<sup>2</sup>**

<sup>1</sup>Yıldız Teknik Üniversitesi, Fen Bilimleri Enstitüsü, İstatistik A.B.D., 34220, İstanbul, Türkiye

<sup>2</sup>Yıldız Teknik Üniversitesi, Fen- Edebiyat Fakültesi, İstatistik Bölümü, 34220, İstanbul, Türkiye

\*Sorumlu yazar e-mail: ecenurgencer@gmail.com

**Özet**

2023 yılı itibarıyla Borsa İstanbul (BİST) yeni yatırımcıların da gelmesiyle tarihi zirvelerine ulaşmış, yapılan yatırımlar ve hareketlilik artmıştır. BİST Sürdürülebilirlik Endeksi (XUSRD); işlem gören, sürdürülebilirlik konusunda bilgilendirmeler yapan, farkındalık yaratan ve bu alanda uygulamalar gerçekleştiren şirketlerin işlem gördüğü bir endeks türüdür. Bu çalışmada 2023 yılında XUSRD’de yer alan şirketler üzerinden yapılan analizler ile şirketlerin performans ölçümü ve finansalları baz alınarak etkinliklerinin ölçülmesi amaçlanmıştır. Şirketlerin bilançoları üzerinden hesaplanan finansallar ile veri zarflama analizinin varsayımı olan homojenlik ilkesini yerine getirebilmek adına hiyerarşik kümeleme analizi kullanılarak kümelemenin etkinlik skorlarında ne denli değişime sebep olduğu incelenmiştir. Kümeleme analizi sonrasında, veri zarflama ile ayrılan herbir grubun belirlenen finansallarına göre etkinlik analizi gerçekleştirilmiştir. Sonrasında, hem ölçeğe göre değişken getir (BCC) hem ölçeğe göre sabit getir (CCR) modellerinin sonuçları lojistik regresyon modeline sokularak, ilgili girdi/çıktı değişkenlerinin etkinlik skorlarını açıklayabilme güçleri tahmin edilmiştir. Kümeleme analizi sonuçları incelendiğinde sürdürülebilirlik endeksinde yer alan şirketlerin finansalları dikkate alınarak dört kümeye ayırılmış olduğu görülmüş, etkinlik analizi ile de 61 şirket için BCC modelinde 30 ve CCR modelinde ise 21 etkin şirket bulunmuştur. Lojistik regresyon analizi ile BCC için %69, CCR için ise %87 oranında tahmin başarısına ulaşılmıştır.

**Anahtar Kelimeler:** Veri Zarflama Analizi, Kümeleme Analizi, Lojistik Regresyon, BİST Sürdürülebilirlik, Etkinlik

## İşletmelerde Müşteri Sadakatine Yönelik Bir Akıllı Erp Uygulaması: Mal Fazlası Hesaplaması

**Hakan Aşan<sup>1\*</sup>, Onur Doğan<sup>1</sup>**

<sup>1</sup>Dokuz Eylül Üniversitesi, İzmir, Türkiye

\*Sorumlu yazar e-mail: hakan.asan@deu.edu.tr

### Özet

İşletmeler müşteri sadakati sağlamak ve alışverişe teşvik etmek için müşterilerine çeşitli ayrıcalıklar, hediyeler, indirimler, bedelsiz ürünler verebilmektedir. En çok tercih edilen yöntem bedelsiz ürün verilmesi diğer adıyla mal fazlasıdır. Müşterilere verilecek mal fazlası miktarı için bir önceki ay satılan malın miktarı, malın toplam fiyatı, beraber çalışılma yılı vb. birçok farklı hesaplama tek başına veya birlikte kullanılmaktadır. Kurumsal kaynak planlaması uygulamalarının da bu konuda sunduğu bazı raporlamalar bulunmaktadır. Ancak genellikle mal fazlası hesaplanması için çeşitli raporlar birleştirilerek manuel bir hesaplama yapılmaktadır. Bu çalışmada mal fazlası hesaplaması için kümeleme algoritması kullanılan akıllı bir model önerilmektedir. Geliştirilen akıllı kurumsal kaynak planlaması uygulaması için öncelikle uzman görüşü ile kriterler belirlenmiş daha sonra bu kriterler kullanılarak kümeleme analizi yapılmıştır. Elde edilen kümelere göre verilecek mal fazlası dağılımı yapılmıştır.

**Anahtar Kelimeler:** Müşteri Sadakati, Kümeleme, Akıllı ERP

**Mitigation of Geological Risk in the Estimation of Hydrocarbon Reserves and Resources of Productive Series in the South Caspian Basin**

**Elvin Ahmedov**<sup>1\*</sup>

<sup>1</sup>Socar

\*Corresponding author e-mail: elvin.ahmadov.h@mail.ru

***Abstract***

*The South Caspian Basin (SCB) is considered one of the unique basins in the world in terms of the volume of hydrocarbon resources, and large-scale geological-geophysical studies have been conducted in this basin. In order to assess the hydrocarbon potential basin, local and foreign companies have been involved to conduct large-scale exploration works. As a result of these studies, 120 structures were discovered in the Azerbaijani part of the SCB, of which 21 structures were identified and involved in development. In general, according to geological, structural-tectonic and lithological-stratigraphic characteristics, the SCB is divided into three parts - Absheron, Baku archipelagos and the Deep Caspian area. The depth of the sea in the basin is determined up to 1000 m. This complicates the process of involving the discovered fields and prospective structures in development. From this point of view, the involvement of new oil and gas fields in the development and the determination of the sequence of directions of exploration works in prospective structures is one of the main priority issues. Evaluation of hydrocarbon reserves and resources of the Productive Series (PS) in the basin with international standards, determination of geological risks, geological justification of ways to reduce risks will create opportunities to determine the directions and sequencing of the next exploration works. All these mentioned confirm the relevance of the research work. The first stage of solving the problem is to analyze the geological, structural-tectonic, lithological-stratigraphic features of the PS in the SCB, taking into account the new data of the exploration, geological-geophysical research conducted by SOCAR and international operating companies and to determine the oil-gas content of the SCB. For this purpose, it is necessary to study the obtained complex geological-geophysical and field data by geological-mathematical methods other than traditional approaches.*

**Keywords:** Field, Hydrocarbon Reserves, Resources Evolution, Risk, Oil and Gas



**Application of Response Surface Methodology for the Optimization of Electrochemical Boron Separation from Aqueous Solution**

**Sevgi Polat**<sup>1\*</sup>

<sup>1</sup>Marmara University, Faculty of Engineering, Department of Chemical Engineering, 34854, İstanbul, Türkiye

\*Corresponding author e-mail: sevgi.polat@marmara.edu.tr

***Abstract***

*Boron exists in nature as boric acid and borate salts, and it can cause pollution by mixing with surface and ground waters and causing environmental pollution. Hence, it is crucial to remove boron in water treatment processes. First, a continuous electrosorption system based on an electrochemical cell was successfully designed to remove boron ions from an aqueous solution. Then, a response surface method involving the Box–Behnken design was used to investigate the effects of three independent variables—flow rate, cell voltage, and boron concentration on the boron adsorption efficiency. The influence of these three independent variables on the removal of boron was evaluated using a second-order polynomial equation. The statistical significance of the model and factors were evaluated using analysis of variance at a 95% confidence level. The experimental design result indicated that flow rate was the most effective parameter in terms of the adsorption efficiency. Acknowledgement: This work was funded by the Scientific and Technological Research Council of Turkey (TUBITAK) with project number 123M952.*

**Keywords:** Boron removal, Box-Behnken design, Electrochemical separation, Optimization

## Iot-based Smart Green-House System with Led Light Control

**Elif Erdal**<sup>1\*</sup>

<sup>1</sup>Tokat Gaziosmanpasa University, Engineering and Architecture Faculty, Mechatronics Engineering,  
60030, Tokat, Türkiye

\*Corresponding author e-mail: erdalselif@gmail.com

### ***Abstract***

*The aim of this study is to develop an intelligent and user-friendly control system to mix color ratios using LED lights for plant growth in a closed vertical greenhouse environment. For this purpose, an experimental test environment and components have been developed to determine the desired light requirements that ensure optimal plant growth in the greenhouse environment. In the study, micro green trials were conducted under D1 (White (6000k-15000k), Green (525nm), Deep Red (665nm), Red (625nm), Pink ( ), UV Purple (365nm), Royal Blue (450nm), Blue (465nm)), D2 (Purple (400-450nm)), D3 (Deep Red (665 nm), Blue (465nm)), and D4 (White led (6000k-6500k)) LED light in a closed vertical greenhouse for 10 days. The appearances of the plants on the 1st, 3rd, 5th, and 10th days were examined. As a result of the trials, while the lengths of parsley, arugula, and lettuce were measured in the D2 trial with the highest purple light, these plants and additionally the length value of radish were measured in the D3 trial with the lowest red and blue light. As can be seen, especially the lengths of the plants vary according to the plant species and the light color to which they are exposed. On the other hand, in terms of leaf width, it was noted that the highest values of all microgreens included in the trial were in the D3 trial where the red and blue light were the highest. The lowest values were observed in the D1 trial with mixed color light. Considering that leaf width is more important than length for microgreens, it can be said that the highest efficiency is achieved with red and blue light. It is important to automate the process of monitoring and ensuring optimum cultivation conditions with minimum human supervision for the system tested in this study. In the future, in addition to this study, it is aimed to create a test environment with mixed color ratios and adjustable LED lighting for high energy efficiency, to improve environmental conditions by adding cameras and soil sensors to the experiments, and to extract data analysis by applying artificial intelligence to the collected data.*

**Keywords:** LED lighting, PPF, Light control, Microgreens, Green-House, IoT

## 2D-QSAR Model Development for D3 Receptor Antagonists

**Lalehan Özalp**<sup>1\*</sup>

<sup>1</sup>Gebze Technical University, Biotechnology Institute, 41400, Kocaeli, Türkiye

\*Corresponding author e-mail: lalehanozalp@marun.edu.tr

### Abstract

*Dopamine (DA) receptors belong to a large rhodopsin-like subfamily of G-protein coupled receptors (GPCRs). D1- and D2-like receptors are two types of DA receptors mediating different physiological functions (Boeckler & Gmeiner, 2006). D3 receptors, belonging to D2-like DA receptors, have drawn attention due to their role in the control of movement (Ayano, 2016; Calabrese et al., 2020; Liu et al., 2011). Additionally, this receptor has been regarded critical since several evidence suggested its potential in the treatment of schizophrenia and Parkinson's disease (Salama et al., 2006). QSAR (quantitative structure-activity relationship) studies have been widely applied to investigate untested compounds for further studies and experiments (Gramatica, 2020). Biological activity and predicted IC50 values are associated by QSAR models. However, there are limitations such as over-estimating the predictive power and sample size. In this study, three different statistical models were applied including multiple linear regression (MLR), multiple non-linear regression (MNL) and artificial neural network (ANN) to overcome these limitations. A set of descriptors were generated and downloaded from ChemDes server (<http://www.scbdd.com/chemdes>). For descriptor selection, stepwise regression was performed (Fig. 1). A dataset consisting of 40 compounds (previously evaluated experimentally) were split into training and test set by ratio of 80% and 20%, respectively. K-means clustering method was performed by using R (R Core Team, 4.1.1) and packages of tidyverse, cluster and factoextra. QSAR models were developed using MLR, MNL and ANN. Based on the results of the constructed 2D-QSAR models, two compounds with the highest activity were selected for further evaluation. Compound 25 and 34 were found to comply with Lipinski's rule of five. This study provided insight into the association between the biological activity of D3 receptor antagonists and molecular structures.*

**Keywords:** D3 Receptor, Qsar, Receptor Antagonists, Biostatistics.



**Bayesci İstatistikler: 1990-2024 Dönemi için İngilizce Olarak Yayınlanan Makalelerin  
Bibliyometrik Analizi**

**Mutlu Altuntas<sup>1\*</sup>, Şenol Çelik<sup>2</sup>**

<sup>1</sup>Sinop Üniversitesi, Fen Edebiyat Fakültesi, İstatistik Bölümü, 57000, Sinop, Türkiye

<sup>2</sup>Bingöl Üniversitesi, Ziraat Fakültesi, Zootekni Bölümü, 12000, Bingöl, Türkiye

\*Corresponding author e-mail: maltuntas@sinop.edu.tr

**Özet**

*Bu araştırmada Web of Science (WoS) veri tabanından 1990-2024 dönemine ait Bayesci İstatistikler konusunda yapılan 5423 tane yayına erişim sağlanmış olup, elde edilen verilerin bibliyometrik analizi yapılmıştır. Veri setinde 229 dergiye ait 7642 yazarın 640 tanesi tek araştırmacı olarak katkıda bulunmuştur. Yayınların yıllara göre dağılımı incelendiğinde, en yüksek makale sayılarının sırasıyla 2016, 2017 ve 2023 yıllarında olduğu tespit edilmiştir. Bu yıllara ait makale sayıları sırasıyla 245, 258 ve 248 olmuştur. 2005-2024 dönemine ait yayın sayısı 100'ün üzerinde seyretmiştir. En sık kullanılan anahtar kelimeler "inference (f=747)", "bayesian analysis (f=625)" ve "models(f=458)" olmuştur. Bunları sırasıyla distributions, regression, model, posterior distributions, prior distributions, likelihood, chain monte-carlo, gibbs sampler ifadeleri izlemiştir. Bayesian Analysis, Statistics in Medicine, Computational Statistics & Data Analysis ve Communications in Statistics-Theory and Methods dergileri alanda en etkili dergiler arasında yer almıştır. En fazla makale üreten yazarlar, Aslam M (f=40), Carlin BP (f=38), Dey DK (f=37) ve Gelfand AE (f=32) olmuştur. En fazla katkı sağlayan kurumlar sırasıyla Duke, Michigan, Minnesota ve Sao Paulo Üniversiteleri olmuştur. Alanda en çok iş birliği yapan ve en güçlü katkıda bulunan ülkelerin ise Amerika Birleşik Devletleri (USA), UK, Çin ve Kanada olduğu saptanmıştır. En yüksek atıf sayısı 53398 ile USA ülkesinden olmuştur. Bu çalışma ile, Bayesci istatistikler konusunda yayınlanan çalışmaların farklı açılardan betimlenerek, araştırmacılar ve uygulama yapanlar için yol gösterici olması hedeflenmiştir. Anahtar kelimeler: Bibliyometri, Bayes, Biblioshiny, Yayın, Dergi. Bayesian Statistics: Bibliometric Analysis of Articles Published in English for the Period 1990-2024. Abstract In this research, 5423 publications on Bayesian Statistics for the period 1990-2024 were accessed from the Web of Science (WoS) database, and bibliometric analysis of the obtained data was performed. In the data set, 640 of 7642 authors from 229 journals contributed as single researchers. When the distribution of publications by years was examined, it was determined that the highest number of articles was in 2016, 2017 and 2023, respectively. The number of articles for these years were 245, 258 and 248, respectively. The number of publications for the period 2005-2024 was over 100. The most frequently used keywords were "inference (f=747)", "bayesian analysis (f=625)" and "models (f=458)". These were followed by the expressions distributions, regression, model, posterior distributions, prior distributions, likelihood, chain monte-carlo, gibbs sampler. Bayesian Analysis, Statistics in Medicine, Computational Statistics & Data Analysis and Communications in Statistics-Theory and Methods journals were among the most influential journals in the field. The authors who produced the most articles were Aslam M (f=40), Carlin BP (f=38), Dey DK (f=37) and Gelfand AE (f=32). The institutions that contributed the most were Duke, Michigan, Minnesota and Sao Paulo Universities, respectively. The United States of America (USA), the UK, China and Canada were found to be the most collaborative and strongest contributors in the field. The highest number of citations was from the USA with 53398. With this study, it is aimed to provide guidance for researchers and practitioners by describing the published studies on Bayesian statistics from different perspectives. Key words: Bibliometrics, Bayes, Biblioshiny, Publication, Journal.*

**Anahtar Kelimeler:** Bibliyometri, Bayes, Biblioshiny, Yayın, Dergi

**Benchmarking: An Overview with an Example to Turkish Universities Under DEA  
Context**

**Ayhan Gölcükcü**<sup>1\*</sup>

<sup>1</sup>Beykent University, Faculty of Engineering - Architecture, Department of Industrial Engineering,  
34475, İstanbul, Türkiye

\*Corresponding author e-mail: ayhangolcukcu@beykent.edu.tr

***Abstract***

*Benchmarking is an important issue originated far past but initially named by Xerox company in 1979. The basis of benchmarking is that companies compare themselves with other actors which are successful and dominates the market and take them as an example. There are numerous examples, and it has its' own literature with many types. Despite this fact, metric benchmarking is appeared as a parallel but separate procedure which is led by operational researchers who are mainly working on DEA, in which different methods are used outside the existing literature. In this study, the gap between classical benchmarking theory and metric benchmarking is filled by an overview and an example will be given by application of DEA to Turkish Universities as a Benchmarking Tool.*

**Keywords:** Benchmarking, DEA, Turkish Universities



**Investigation of Marriage-Divorce Pattern of Turkish Regions Using Mcdm and Machine Learning Approaches**

**Pakize Yiğit<sup>1\*</sup>, Fatma Sevinç Kurnaz<sup>2</sup>, Ozan Evkaya<sup>3</sup>**

<sup>1</sup> İstanbul Medipol Üniversitesi, İstanbul, Türkiye

<sup>2</sup> Yıldız Teknik Üniversitesi, İstanbul, Türkiye

<sup>3</sup>University of Edinburgh, Scotland

\*Corresponding author e-mail: pyigit@medipol.edu.tr

***Abstract***

*The changes in family unity and the resulting demographic structures are significant areas of study in both developed and developing countries. Turkey has great regional differences in terms of socioeconomic and demographic structures, so their association is very crucial to find successful policies. This study aims to investigate the changes in Turkey's socioeconomic changes in recent years, with the increase in divorces and the age of first marriage due to a decrease in fertility. The study aims to find regional differences in Turkey performing a four-stage framework based on CRITIC-GRA (Inter-criteria Correlation (CRITIC) method based Grey Relational Analysis), Kohonen SOM (Self Organizing Maps) and MDS analysis finding marriage divorce and related socioeconomic factors. The data obtains from Turkish Statistical Institute (TURKSTAT) and Turkey Demographic and Health Surveys (TDHS) for 26 regions of Türkiye. Firstly, CRITIC-GRA is used to find the factor's weight. Subsequently, the weights are used for ANN based-SOM clustering Analysis. After obtaining SOM weight vectors, MDS analysis performs the vectors to have better similarities and differences between regions. The study proposes to investigate social changes in a novel methodology.*

**Keywords:** MCDM, SOM, MDS, CRITIC, Grey Relational Analysis



**An Application of Cluster Analysis in the Automotive Sector**

**Nida Oruç<sup>1\*</sup>, Çağrı Can<sup>2</sup>**

<sup>1</sup>Istanbul Topkapı University, Management Information Systems, 34662, Istanbul, Türkiye

<sup>2</sup>Yıldız Technical University, Statistic, 34220, Istanbul, Türkiye

\*Corresponding author e-mail: nidaoruc@topkapi.edu.tr

***Abstract***

*The data used in this study was obtained through Kaggle. The main goal is to make an application under the umbrella of artificial intelligence. The data set contains 8 variables representing various characteristics of cars, as well as a descriptive variable for each car. The aim of this study is to first prepare the data for cluster analysis and then apply this analysis. K-means method was used in cluster analysis. Additionally, the Elbow method was used to determine the appropriate number of clusters. As a result, the data set was divided into 4 clusters. Then, the centers of these clusters were determined. As a result, 4 clusters were obtained. Then, the analysis continued with visualizations. As a result, the results obtained by cluster analysis were compared according to the resulting data. This study can help automakers make strategic decisions and gain competitive advantage.*

**Keywords:** Artificial Intelligence, Cluster Analysis, K-means, Elbow Method



## Classification of Eye Diseases in Fundus Images Using Deep Learning Algorithms

Kübra Buzlu<sup>1</sup>, Yaren Can<sup>1</sup>, Hüseyin Taşkın<sup>1</sup>, Ayşe Berna Altinel<sup>1\*</sup>, Abdulsamet Aktaş<sup>1</sup>

<sup>1</sup>Marmara University, Faculty of Technology, Department of Computer Engineering, 34854, Istanbul, Türkiye

\*Corresponding author e-mail: [berna.altinel@marmara.com.tr](mailto:berna.altinel@marmara.com.tr)

### *Abstract*

*Analysis of fundus images is crucial in preventing blindness by enabling early diagnosis of eye diseases. Additionally, through the analysis of fundus images, the need for specialists can be reduced, and the workload of experts can be eased. By motivating these important goals, in this study we studied on the Ocular Disease Recognition Dataset (ODIR) consisting of 6392 eye fundus images and containing eight different disease categories. The dataset includes images belonging to Age-related Macular Degeneration, Cataract, Diabetes, Glaucoma, Hypertension, Normal, Pathological Myopia, and other diseases. To balance the imbalanced distribution among the classes in the dataset, training data has been increased by adding some suitable synthetic images into corresponding classes. Furthermore, black areas surrounding the fundus images were cropped, and the data was resized to fit the deep learning model to be used. Two different versions of the data were created by applying CLAHE and Gaussian Blur. During the study, the data was tested with InceptionV3, Xception, DenseNet121, and MobileNetV2 models. The experimental results obtained in the study show that, the model trained with DenseNet121 achieved more successful results compared to other models when the training data of the dataset was augmented using traditional methods to have 3500 samples in each class. Experimental results show that 86% F1 score is achieved for Pathological Myopia.*

**Keywords:** Eye Diseases, Medical Image Classification, Fundus Images Analysis, Ocular Disease Recognition Dataset (ODIR), Deep Learning

**Frequency of Use of Partial Least Squares Structural Equation Modelling (pls-sem) in Educational Administration Research**

**Murat Polat**<sup>1\*</sup>

<sup>1</sup>Mus Alparslan University, Faculty of Education, Department of Educational Sciences, 49250, Muş, Türkiye

\*Corresponding author e-mail: m.polat@alparslan.edu.tr

***Abstract***

*As a social science field, it can be said that the tendency to use quantitative statistical methods in educational sciences research, just like in other sub-fields (sociology, psychology, etc.), dates back to quite a long time. Naturally, "educational administration", as one of the sub-disciplines of educational sciences, also has its share of this process. In the literature review studies on the subject, it is seen that many basic and advanced quantitative statistical studies have been carried out methodologically, and structural equation modelling studies are at the forefront. However, Covariance Based (CB) SEM methods are used in the vast majority of structural equation modelling studies especially in the field of educational administration. In this case, it can be argued that useful modelling types such as Partial Least Squares Modelling (PLS-SEM) are still rarely used. Therefore, the main purpose of this study is to determine the frequency of using PLS-SEM approach in educational administration research. Thus, it is envisaged that both the level of awareness of educational sciences researchers on the subject can be increased and a general research map can be created for researchers who will use the PLS-SEM approach. For this purpose, bibliometric scientific mapping technique was applied and Scopus database was used. VOSviewer software was used to analyse the research data.*

**Keywords:** PLS-SEM, Partial Least Squares Structural Equation Modelling, Educational Administration, Educational Management



**Kişi - Örgüt Uyumunun İş Tatmini Üzerindeki Etkisinin İncelenmesi: İnşaat Sektöründe İşgörenler Üzerinde Bir Araştırma**

**Ümran Şengül<sup>1\*</sup>, Selen Erdal<sup>2</sup>**

<sup>1</sup>Çanakkale Onsekiz Mart Üniversitesi, Siyasal Bilgiler Fakültesi, İşletme Bölümü, Sayısal Yöntemler ABD, 17200, Çanakkale, Türkiye

<sup>2</sup>Çanakkale Onsekiz Mart Üniversitesi, Siyasal Bilgiler Fakültesi, Uluslararası İşletmecilik Tezli YL, 17000, Çanakkale, Türkiye

\*Sorumlu yazar e-mail: umransengul@comu.edu.tr

**Özet**

Araştırmanın amacı, inşaat sektöründe çalışanların kişi-örgüt uyumunun iş tatmini üzerindeki etkisini anlamaktır. İş tatmininin olumlu veya olumsuz olması, birçok örgütsel sonucu etkilemektedir. Dolayısıyla, inşaat sektöründeki işletmelerin performansı, çalışan bağlılığı ve genel örgütsel deneyimleri üzerinde önemli bir etkiye sahip olabilecek bu faktörlerin araştırılması önemlidir. Bu araştırma, inşaat sektöründe çalışanların kişi-örgüt uyumunu iş tatmini üzerindeki etkisi açısından incelerken, aynı zamanda işletmelerin performansını artırmak için stratejiler geliştirmeye yönelik önemli bir katkı sağlamayı hedeflemektedir. Bu çalışmada öncelikle kişi-örgüt uyumu ve iş tatmini kavramları açıklanmıştır. Araştırmanın örneklemini Çanakkale ili Merkez ilçesinde faaliyet gösteren iki farklı inşaat firmasının altında çalışan altı farklı taşeron grubu oluşturmuştur. Bu gruplar arasında usta, işçi, firma yöneticisi, mühendis ve şantiye şefleri bulunmaktadır. Örneklemin oluşturulmasında kolayda örnekleme yöntemi tercih edilmiştir. İnşaat firmalarının yöneticilerinden alınan izinler doğrultusunda, 120 anket formu dağıtılarak bu kapsamda 104 anket formu (%86) geri dönmüştür. Geri dönen anket formlarından 100 adedi (%83) değerlendirmeye alınmıştır. Anket uygulamasından elde edilen verilerin SPSS Statistics Programı ile Geçerlilik ve Güvenilirlik Analizleri yapılmıştır. Hipotezler test edilmiştir. Günümüz iş yaşamındaki hızlı değişimlerin bireylerin kariyer hedeflerini ve çıkarlarını etkileyerek iş tatminini ve kişi-örgüt uyumunu ön plana çıkardığı görülmektedir. İş tatmini, bir çalışanın işine, koşullarına ve ortamına duyduğu memnuniyeti ifade ederken, bu memnuniyetin kişinin performansını, motivasyonunu ve iş yaşam kalitesini etkilediği bilinmektedir. Ancak, rekabet, baskı ve talep artışının iş tatmini üzerinde olumsuz etkileri olduğu, bu durumun kişi-örgüt uyumunu zayıflatabileceği gözlemlenmektedir. Çalışmanın amacı, kişi-örgüt uyumunun iş tatmini üzerindeki etkisini incelemektir ve yapılan araştırmaların bu ilişkiyi desteklediği belirtilmektedir. Araştırma, destekleyici uyum, ihtiyaç-arz uyumu, talep-yetenek uyumu, tamamlayıcı uyum gibi uyum alt boyutlarının iş tatmini ile anlamlı bir ilişki içinde olduğunu göstermektedir. Demografik faktörlerin analizi, kişi-örgüt uyumunun iş tatmini üzerindeki etkisinin bazı faktörlere göre değişmediğini ancak yaş ve sektördeki toplam çalışma süresi üzerinde anlamlı farklılık gösterebileceğini ortaya koymaktadır. Bu araştırma, kişi-örgüt uyumunun iş tatmini üzerinde pozitif bir etkisi olduğunu göstermektedir. Bu, çalışanların örgütleriyle uyum içinde olmalarının iş tatmini düzeylerini artıracağını gösterir. Kişi-örgüt uyumunun alt boyutlarına odaklanarak daha detaylı bir inceleme yapmıştır. Bulgulardan çıkarılabilecek sonuçlara göre, iş dünyasındaki liderler ve insan kaynakları uzmanları için önemli bir kılavuz niteliği taşımaktadır.

**Anahtar Kelimeler:** Kişi-örgüt uyumu, İş tatmini, İnşaat

**Examining the Relationship Between Climate Change, Energy Consumption, and the Financial System: The Case of E7 Countries**

**Naime İrem Duran<sup>1</sup>, Özge Demirkale<sup>2\*</sup>**

<sup>1</sup>Ph.D., Asst. Prof., Beykent University, Faculty of Economics and Administrative Sciences, Capital Markets Department, 34700, Istanbul, Türkiye

<sup>2</sup>Ph.D., Asst. Prof., Istanbul Aydın University, Faculty of Economics and Administrative Sciences, Department of Business, Administration, Istanbul, Türkiye

\*Corresponding author e-mail: ozgedemirkale@aydin.edu.tr

***Abstract***

*This study aims to investigate the correlation among climate change, energy consumption, and the financial system, using the E7 countries as a case study. The E7 comprises emerging economies including Brazil, China, India, Russia, Turkey, Indonesia, and Mexico, which are the primary focus of this research. The research delves into the factors impacting CO2 emissions over the long term, spanning from 1992 to 2020. Results reveal a positive correlation between economic growth and fossil fuel usage with CO2 emissions, while a negative correlation is identified between CO2 emissions and variables such as renewable energy consumption, temperature changes, and capital investments. The study underscores the significance of sustainability and environmental policies for the E7 nations. Recommendations include increasing investments in renewable energy sources, encouraging the adoption of carbon-neutral transportation technologies, and supporting initiatives for forest conservation and afforestation. In conclusion, this study provides valuable insights into the relationship between climate change, energy consumption, and the financial system within E7 countries, offering policy recommendations for achieving sustainability.*

**Keywords:** Climate Change, Energy Consumption, Financial System, E7 Countries, Panel ARDL

**Sustainability Reporting and Determination of the Relationship between Short-Term Debt and Profitability of Food Enterprises in BIST Sustainability Index with Panel Data Analysis**

**Ali Uslu<sup>1\*</sup>, Serdar Budak<sup>1</sup>**

<sup>1</sup>Tokat Gaziosmanpaşa University, Turhal Faculty of Applied Sciences, Department of International Trade and Logistic, 60300, Tokat, Türkiye

\*Corresponding author e-mail: ali.uslu@gop.edu.tr

***Abstract***

*Societies have entered a period of rapid economic and technological change and development with the industrial revolution. Instead of manual production, mechanized fabrication production was introduced. In this period, production increased along with productivity. The increase in resource utilization with the increase in production has led to extraordinary consumption of resources. In addition, the wastes generated as a result of production started to pose a problem for living things in the biosphere. The Covid-19 pandemic, Russia-Ukraine war, Israel's invasion of Gaza, civil unrest in the Middle East, and security threats in the Red Sea, an important trade route, have attracted the attention of both companies and society. These developments have highlighted the need to take measures to ensure access to and sustainability of already inadequate production resources. In recent years, stakeholders, managers, investors, government and society have been demanding not only financial information but also non-financial information such as carbon footprint and value added to society. In addition, it has become necessary to use an accounting system that takes into account the factors that adversely affect the environment such as raw materials, water, energy efficiency, waste water, various gases, wastes, waste materials used in the production activities and calculates environmental costs. Environmental costs will also create an additional financial burden on business budgets. Environmental costs will be financed with equity or by borrowing. In the study, the issue of whether short-term debt affects profitability was investigated by panel data analysis using quarterly financial data for the period 2020 Q1 - 2023 Q4 from the independent audit reports obtained from the Public Disclosure Platform and the websites of the food companies included in the BIST Sustainability index. In this context, the dependent variables of the analysis are determined as Equity / Total Assets, Gross profit / Revenue, Operating profit / Revenue, Net profit for the period / Revenue and the independent variables are determined as Short-term liabilities / Equity, Liquidity ratio (Current assets-inventories / short-term liabilities) and Net working capital turnover (Net sales / current assets- Short-term liabilities). Panel Data Analysis is used as the methodology. In this method, horizontal cross-section dependence and unit root tests were conducted and regression models were constructed in line with the results obtained. In this context, it is analyzed whether the independent variables have an effect on the dependent variables. As a result of the Panel Data Analysis conducted with the established models, it was determined that there were statistically significant results between some variables.*

**Keywords:** Sustainability Reporting, Accountant, Panel Data Analysis



**Türkiye için Yüzyıllıklar ve Süper Yüzyıllıkların Tahmini**

**Özer Bakar<sup>1\*</sup>, İsmet Koç<sup>2</sup>, Murat Büyükyazıcı<sup>1</sup>, Dolunay Ezgi Gümüşbaş<sup>3</sup>, Uğur Erensayın<sup>2</sup>,  
İrem Menekşe<sup>1</sup>**

<sup>1</sup>Hacettepe Üniversitesi, Fen Fakültesi, Aktüerya Bilimleri Bölümü, 06800, Ankara, Türkiye

<sup>2</sup>Hacettepe Üniversitesi, Nüfus Etütleri Enstitüsü, 06800, Ankara, Türkiye

<sup>3</sup>Hacettepe Üniversitesi, Fen Fakültesi, İstatistik Bölümü, 06800, Ankara, Türkiye

\*Corresponding author e-mail: ozerbakar@hacettepe.edu.tr

**Özet**

Yüzyıllıklar (centenarians), belirlenen yıl için 100 ve 104 yaş arasındaki, Yarı-süper Yüzyıllıklar (semi-supercentenarians) 105 ve 109 yaş arasındaki, Süper Yüzyıllıklar (supercentenarians) ise 110 ile 110 yaşını aşmış bireyleri ifade eder. Uluslararası İnsan Ölümlülüğü Veritabanı (Human Mortality Database, HMD) barındırdığı ülkelerin resmi istatistik ofislerinden elde ettiği veri ile Kannisto mortalite modeli kullanarak açık yaş aralığındaki ölüm sayılarını her ülke için tekli yaşlarda 110+ açık yaş aralığına kadar yeniden hesaplamaktadır. Türkiye İstatistik Kurumu (TÜİK) tarafından derlenen yıllık ölen kişi sayıları 98+ şeklinde 98 yaş ve sonrası ölen kişi sayıları olarak açıklanmaktadır. Bu çalışmada+ 2009-2020 yılları arasında Türkiye için 98+ açık yaş aralığındaki ölüm sayılarına HMD yöntemi uygulanarak, 110+ açık yaş aralığına kadar tekli yaşlar ve tekli yıllar için ölüm sayıları elde edilmiştir. +Bu çalışma TÜBİTAK 123R017 numaralı “Türkiye için Uluslararası Ölümlülük Veri Tabanının Oluşturulması ve Sürdürülebilirliğinin Sağlanması ve Öncelik Alanlarının Belirlenmesi” projesinden üretilmiştir.

**Anahtar Kelimeler:** Uzun Ömürlülük, Mortalite Modeli, Yaşam Fonksiyonu, Sentetik Kuşak, Ölen Kişi Sayısı.

**Bayesian Estimation of the Inverse Pareto Distributions Based on the Joint  
Progressively Censored Data**

**Kapil Kumar**<sup>1\*</sup>

<sup>1</sup>Department of Statistics, Ch. Charan Singh University, Meerut-250004, India

\*Corresponding author e-mail: kapilstats@gmail.com

***Abstract***

*This study deals with the Bayesian estimation of the inverse Pareto distributions based on the joint progressively censored data. The Bayes estimates of the parameters are derived under the Linex loss function. To compute the Bayes estimate, the Tierney-Kadane (T-K) approximation and Markov chain Monte Carlo (MCMC) methods are used. The highest posterior density (HPD) credible intervals based on the MCMC method are also developed. A numerical study is performed to check the performance of the efficiency of developed estimates. A pair of real data sets is studied for illustration purposes.*

**Keywords:** *Inverse Pareto Distribution, Bayesian Estimation, T-K Approximation, MCMC Method*



## A Deep Dive into the Support Vector Machines and Their Applications in Natural Sciences

**Uğurcan Demir<sup>1\*</sup>, Onur Köksoy<sup>1</sup>**

<sup>1</sup>Ege University, Department of Statistics, 35040, İzmir, Türkiye

\*Corresponding author e-mail: [ugur.can.demir@hotmail.com](mailto:ugur.can.demir@hotmail.com)

### ***Abstract***

*Support Vector Machines (SVMs) have emerged as powerful tools in machine learning, finding extensive applications across various domains due to their ability to handle both classification and regression tasks effectively. In this presentation, we delve into the significance of SVMs and give some important examples. We discuss the mathematical foundation of Support Vector Machines by providing a solid framework for understanding their underlying principles. By exploring the mathematical properties of SVMs, we clarify their core concepts, including margin optimization and the kernel trick. This mathematical exposition equips researchers and practitioners with a deeper comprehension of SVMs, enabling more informed model selection and parameter tuning strategies. We close by giving some applications of Support Vector Machines in natural sciences, where the accurate analysis of complex data plays a pivotal role. We present compelling case studies that illustrate the power of SVMs in real-world scenarios. By harnessing the predictive power of SVMs, researchers in natural sciences can glean valuable insights from complex datasets.*

**Keywords:** *Support Vector Machines, Kernel Trick, Loss Functions, Model Optimization, Statistical Learning Theory*



**Machine Faults Detection with Nonlinear Features for Predictive Maintenance Applications**

**Ahmet Mert Demirbas<sup>1\*</sup>, Derya Yilmaz<sup>2</sup>**

<sup>1</sup>Türk Havacılık ve Uzay Sanayii A.Ş., Department of Flight Test Instrumentation, 06980, Ankara, Türkiye.

<sup>2</sup>Gazi University, Faculty of Engineering, Department of Electrical and Electronics Engineering, 06570, Ankara, Türkiye.

\*Corresponding author e-mail: ahmetmertdemirbas@gmail.com

**Abstract**

*The proper maintenance schemes containing smart technologies have become a great need to ensure continuity in production or service as the need for mechanization and machine diversity in the industry increases day by day. This approach, called predictive maintenance, can also increase productivity by preventing extra costs and loss of time resulting from maintenance performed early or after a problem is detected on the machine with traditional maintenance methods. The aim of this study is to put forward an approach to ensure that any malfunction requiring maintenance on the used equipment is detected before the device breaks down, with the concept of predictive maintenance. Many studies in the literature have shown that physical measurements such as vibration, sound, and temperature provide information about the machine's fault condition, especially for an electric motor. In this study, the MAFAULDA dataset containing three-axis vibration data from two acceleration sensors at different RPM values from an electric motor for the cases of horizontal misalignment, unbalance, bearing and vertical misalignment faults etc. and normal state. In the study, in addition to the features calculated in the time and frequency domain on acceleration data, some features such as average mutual information, Higuchi dimension, Katz dimension and entropy, which are based on nonlinear analysis were used, unlike the literature. The multi-class classification for ten different fault classes was realized with the features obtained from both sensors by using the MATLAB Classification Learner application, and an accuracy of 99.1% was achieved with the Decision Trees classifier. Then, the classification procedure was repeated by reducing the number of sensors to one and the accuracy rate of 96.2% was achieved with the same classifier. When similar studies in the literature were examined, the highest classification accuracy was obtained with a single sensor. The results of this study are important as they show that nonlinear features provide useful information that especially supports the use of fewer sensors.*

**Keywords:** Predictive Maintenance, Classification, Vibration, Electric Motor, Machine Learning.

**Predictive Analytics in E-commerce: A Case Study on Next-item Recommendation  
Using User Interaction Data**

**Burak Tağtekin<sup>1\*</sup>, Halil Akgün<sup>2</sup>, Tuna Çakar<sup>3</sup>**

<sup>1</sup>Insider, Predictive Analytics Department, Istanbul, Türkiye

<sup>2</sup>Insider, Engineering Manager, Istanbul, Türkiye

<sup>3</sup>Mef University, Computer Engineering Department, 34396, Istanbul, Türkiye

\*Corresponding author e-mail: burak.tagtekin@useinsider.com

***Abstract***

*In this study, we aim to predict the next product a user will likely explore based on their historical interactions. This involves using a dataset meticulously crafted from user activities such as viewing product details, adding items to a cart, or making purchases. Notably, the dataset organizes interactions into three main category columns that progress from general to more specific categories, for example, "Men - Tshirt - White Patterned Tshirt". Data is gathered hourly via backend ETL (Extract, Transform, Load) processes orchestrated by Airflow, enabling the capture of session-specific product interactions. Preparatory steps during ETL processes transform raw data into a structured table format, making it suitable for modeling. For modeling, we employ the 'Transformers4Rec' framework, designed for the 'next-item-prediction' task. The model is trained using tools directly from Nvidia's software repository and, upon completion, is served through our custom 'model-serving-api'. It is then packaged with MLflow and stored on Amazon S3 for reuse. The model server API periodically syncs with GUIDs collected based on keywords stored in Redis, ensuring that the synchronized model is readily accessible via its endpoint. From the extracted data, significant interaction counts and engagement ratios were observed, which were critical in training and validating our model. For instance, one sample data showed consistent user interactions across different categories with a notable peak interaction count of 350 and an average engagement ratio reaching 100% in certain categories. Similarly, "Spotlight Australia" provided extensive data with interaction counts reaching as high as 3000 and varying engagement ratios that helped in refining the model's accuracy across diverse product ranges. The goal of this project is to enhance user experience on e-commerce platforms by enabling better understanding and prediction of customer behavior. Implementing this project has the potential to significantly boost customer loyalty and offer personalized shopping experiences, thereby enhancing the efficiency and competitive edge of e-commerce platforms. This approach not only aligns with current technological advancements but also opens new avenues for predictive analytics in retail.*

**Keywords:** *Next-item Prediction, User Interaction Data, Transformers4Rec Framework, Model-Serving API, Predictive Analytics in Retail*

## Design and Implementation of Advanced Recommendation Systems for an Online Video Streaming Platform

**Tunahan Bozkan<sup>1\*</sup>, Ayşenur Yıldız<sup>2</sup>, Erkan Kara<sup>3</sup>, Tuna Çakar<sup>4</sup>**

<sup>1</sup>Mef University, Informatics Technologies Masters Program, 34396, Istanbul, Türkiye

<sup>2</sup>Andromeda Tv Digital Plat. Op. Inc., R&d/design Center Specialist, Istanbul, Türkiye

<sup>3</sup>Andromeda Tv Digital Plat. Op. Inc., R&d Manager, Istanbul, Türkiye

<sup>4</sup>Mef University, Computer Engineering Department, 34396, Istanbul, Türkiye

\*Corresponding author e-mail: bozkant@mef.edu.tr

### *Abstract*

*This study details the design and implementation of sophisticated recommendation systems for an online video streaming platform with 250,000 users, aimed at maximizing user experience. Various recommendation algorithms were evaluated and integrated to deliver personalized movie and series suggestions based on user segmentation, viewing histories, demographic features, and preferences. Three primary recommendation system algorithms were tested: collaborative filtering, content-based filtering, and hybrid methods. Collaborative filtering offered recommendations based on user similarities, while content-based filtering suggested content aligning with the user's past preferences. Hybrid methods aimed to combine these approaches to enhance accuracy in recommendations. Recommendations generated by each algorithm were subsequently utilized as inputs for a meta-level recommendation model. This meta-model synthesized suggestions from different algorithms to produce an optimized final set of recommendations for each user segment. For instance, recommendations for young adults were weighted more heavily on popularity and current trends, whereas those for older segments prioritized content quality and user ratings. The efficacy of these recommendation systems was measured through A/B testing on our user base. Preliminary findings indicate significant improvements in user satisfaction and engagement rates compared to previous models. Customized recommendations tailored to viewer segments have increased user retention and content consumption on the platform. This study underscores the positive impact of complex recommendation systems on user experience and their critical role in enhancing the overall success of the platform.*

**Keywords:** Recommendation Systems, User Experience Optimization, Collaborative Filtering, Content-Based Filtering, Hybrid Recommendation Methods



## Enhancing Sales Forecasting in Retails with Machine Learning Methods

Sezgi Ayhan<sup>1\*</sup>, Zeynep Şahin<sup>2</sup>, Ayşe Kızılay<sup>3</sup>, Tuna Çakar<sup>4</sup>

<sup>1</sup>Mef University, Big Data Analytics Masters Program, 34396, Istanbul, Türkiye

<sup>2</sup>Eve Retail Inc., R&d Manager, 34768, Istanbul, Türkiye

<sup>3</sup>Eve Reatil Inc., Cto, Postal Code, 34768, Istanbul, Türkiye

<sup>4</sup>Mef University, Computer Engineering Department, 34396, Istanbul, Türkiye

\*Corresponding author e-mail: ayhans@mef.edu.tr

### *Abstract*

*This study investigates the application of various supervised machine learning algorithms for sales forecasting at Eve Retails in the post-COVID-19 market landscape. It highlights the importance of robust data collection and processing to effectively navigate changing market conditions and consumer behaviors. The research evaluates multiple algorithms, including ARIMA, SARIMA, Ridge Regression, Polynomial Regression, XGBoost, and LightGBM. Among these, LightGBM emerged as the standout performer based on essential performance metrics, though the anticipated influence of campaign data on the model's predictions was minimal. A significant aspect of this analysis is the use of SHAP analysis, which helped identify the impact of different features on model explainability, notably emphasizing the role of traffic and date data. These insights underscore the subtle factors that influence predictive accuracy in the e-commerce environment. The study emphasizes the critical need for sophisticated forecasting models to enhance various aspects of e-commerce operations, such as inventory management, supply chain logistics, pricing strategies, and customer relationship management. It demonstrates how machine learning models can provide businesses with a competitive edge by enhancing the accuracy of future sales predictions. Overall, this research highlights the vital role of machine learning in improving sales forecasting accuracy within the e-commerce sector, setting a standard for future research and practical applications aimed at enhancing these models for greater reliability and accuracy. The findings offer valuable insights for businesses aiming to utilize data analytics for strategic decision-making in an increasingly digital marketplace.*

**Keywords:** Machine Learning Algorithms, Sales Forecasting, LightGBM Performance, SHAP Analysis, Data-Driven Decision Making

## The Impact of Ai-enhanced Virtual Reality Systems on Shopping Experiences

Elif Gül<sup>1</sup>, Buse Apaydın<sup>1</sup>, Zeynep Şahin<sup>2</sup>, Ayşe Kızılay<sup>3</sup>, Tuna Çakar<sup>4\*</sup>

<sup>1</sup>Eve Retail Inc., Software Engineer, 34768, Istanbul, Türkiye

<sup>2</sup>Eve Retail Inc., R&d Manager, 34768, Istanbul, Türkiye

<sup>3</sup>Eve Reatil Inc., Chief Technology Officer, 34768, Istanbul, Türkiye

<sup>4</sup>Mef University, Computer Engineering Department, 34396, Istanbul, Türkiye

\*Corresponding author e-mail: cakart@mef.edu.tr

### *Abstract*

*This study investigates the transformative potential of artificial intelligence (AI) enhanced virtual reality (VR) systems in the retail sector, focusing particularly on the development processes of AI models. By integrating VR and AI-driven recommendation systems, we explore how these technologies redefine shopping experiences by providing personalized and interactive environments. The study delves into the development and optimization of collaborative filtering models, such as Singular Value Decomposition (SVD), SVD++, and Non-negative Matrix Factorization (NMF), assessing their impact on user satisfaction and shopping efficiency. Initially, our work benchmarks these models using metrics such as Root Mean Square Error (RMSE) and Mean Absolute Error (MAE) to ensure effectiveness in offering tailored shopping recommendations. Key phases in our model development process include data collection, preprocessing, model training, testing, and integration. Special emphasis is placed on the interaction of these models with real-world shopping data, illustrating the refined capability of AI systems to adapt to diverse consumer behaviors and preferences dynamically. Throughout the conference, we will present findings that show substantial enhancements in the engagement and satisfaction of users interacting with VR interfaces, supported by AI recommendations. These results are particularly pronounced when the AI models are fine-tuned with advanced algorithms capable of handling complex datasets. Additionally, the paper discusses the broader implications of these technologies on retail strategies, including increased customer retention and a stronger brand-consumer relationship. In conclusion, the synergy between VR and AI not only elevates the shopping experience but also serves as a powerful tool for retailers to understand and meet consumer demands more effectively. Future research directions will focus on expanding the application of these models to different retail settings and exploring the scalability of the developed systems.*

**Keywords:** Artificial Intelligence in Retail, Virtual Reality Shopping, AI-Driven Recommendation Systems, Collaborative Filtering Models, Consumer Behavior Adaptation

## Modeling Reasons for Customer Churn in the Pay-TV Sector with Supervised Machine Learning

**Önder Genç<sup>1\*</sup>, Yasemin Kurtçu Meşe<sup>2</sup>, Emir Obalı<sup>3</sup>, Veysel Karani Yılmaz<sup>4</sup>, Ebru Öz<sup>4</sup>, Ayşenur Yıldız<sup>5</sup>, Erkan Kara<sup>6</sup>, Tuna Çakar<sup>7\*</sup>**

<sup>1</sup>MEF University, Graduate School of Science and Engineering, Information Technologies, 34396, İstanbul, Türkiye

<sup>2</sup>Andromeda TV Digital Plat. Op. Inc., CVM and Loyalty Director, İstanbul, Türkiye

<sup>3</sup>Andromeda TV Digital Plat. Op. Inc., Subscriber Retention Manager, İstanbul, Türkiye

<sup>4</sup>Andromeda TV Digital Plat. Op. Inc., Inf. Tech. and System Network CTO, İstanbul, Türkiye

<sup>5</sup>Andromeda TV Digital Plat. Op. Inc., R&D/Design Center Specialist, İstanbul, Türkiye

<sup>6</sup>Andromeda TV Digital Plat. Op. Inc., R&D Center Manager, İstanbul, Türkiye

<sup>7</sup>MEF University, Graduate School of Science and Engineering, Information Technologies, 34396, İstanbul, Türkiye

\*Corresponding author e-mail: cakart@mef.edu.tr

### Abstract

*Pay TV services have become a highly competitive industry with the entry of different companies into the market. Increasing service diversity creates a more competitive environment among companies. According to research by Strait Research, the Global Pay TV market, which was measured at 183 million dollars in 2021, is expected to reach 210 million dollars in 2030. Additionally, a study conducted by Netflix emphasized that the value of acquired or existing subscribers is higher. It is of great importance for companies to be able to predict the possibility of customers canceling their subscriptions. The increasing effectiveness of techniques such as machine learning and artificial neural networks in recent years has facilitated forecasting processes and provided significant benefits to companies. In this study, customer abandonment reasons were modeled with various machine learning models, using data from a company that provides Pay TV services. As a result of identifying customers with a high probability of requesting subscription cancellation, analyzing information about recent subscription cancellation requests and frequent cancellation requests, it is aimed to reach customers before they cancel their subscription and to prevent cancellation by recommending appropriate campaigns. Within the scope of the research, supervised learning techniques were used on labeled data. In the study, algorithms such as Random Forest, XG Boost Classifier, K-nearest Neighbors Classifier, Logistic Regression, Ada Boost Classifier, Decision Tree Classifier, Extra Tree Classifier and Linear Discriminant Analysis were applied. Hyperparameter study was conducted using GridSearchCV. The most suitable parameters for the models were determined. Performance metrics were determined and compared for all models. Classification Report results were obtained, and model performances were compared. According to the findings, it was determined that the most appropriate model in terms of data received from the service provider was Decision Tree. This process has the potential to increase the competitiveness of companies in the Pay TV sector by contributing to the development of strategies to prevent customer abandonment. Model results are shared below. In the model results, it was determined that Logistic Regression, Decision Tree and*



*Extra Tree models achieved 90% or more success according to both test and validation data sets. According to the same results, it was seen that the result of the K-Nearest Neighbors model was very low. When the results are evaluated; The Decision Tree model is as follows; Macro Avg. Precision: 94%, Macro Avg. Recall: 93%, Macro Avg. F1-Score: 93%, Weighted Avg. Precision: 99%, Weighted Avg. Recall: 99%, Weighted Avg. F1-Score: 99% and Accuracy: 99%. According to the results, it was decided to work with the Decision Tree model.*

**Keywords:** *Supervised, Machine Learning, Churn, Pay-TV*



## Enhancing E-commerce Sales Forecasting: A Comparative Analysis of Machine Learning Algorithms in the Post-pandemic Era

Ayçelen Pamuk<sup>1\*</sup>, Murat Deniz Parmaksız<sup>2</sup>, Tuna Çakar<sup>3</sup>

<sup>1</sup>Mef University, Informatics Technologies Masters Program, 34396, Istanbul, Türkiye

<sup>2</sup>Insider, Sosyo Plus Information Inf. Tech. Cons. Services Inc., Istanbul, Türkiye

<sup>3</sup>Mef University, Computer Engineering Department, 34396, Istanbul, Türkiye

\*Corresponding author e-mail: pamuka@mef.edu.tr

### *Abstract*

*This study explores the use of various supervised machine learning algorithms for e-commerce sales forecasting in the evolving post-COVID-19 market environment. It emphasizes the significance of robust data collection and processing to adeptly navigate changing market conditions and consumer behaviors. The research assesses multiple algorithms, such as ARIMA, SARIMA, Ridge Regression, Polynomial Regression, XGBoost, and LightGBM. LightGBM distinguished itself as the best performer according to essential performance metrics. However, the anticipated impact of campaign data on the models' predictions was found to be surprisingly minimal. A key component of this analysis is the SHAP analysis, which helped determine the influence of different features on model explainability, particularly highlighting the importance of traffic and date data. These insights point to the nuanced factors affecting predictive accuracy in the e-commerce context. Numerically, the LightGBM model demonstrated superior performance with the lowest error rates and highest predictive accuracy among the models tested. For instance, in comparison metrics, LightGBM achieved an  $R^2$  value of 94.3%, a Root Mean Square Error (RMSE) of 9,945, and a Mean Absolute Percentage Error (MAPE) of 8.52%, suggesting its robust capability in handling the complexities of e-commerce data. The study underlines the critical need for sophisticated forecasting models in e-commerce to enhance inventory management, supply chain operations, pricing strategies, and customer relationship management. It reveals how machine learning models can furnish businesses with a competitive advantage by improving the accuracy of future sales predictions. Conclusively, this research underscores the essential role of machine learning in advancing sales forecasting accuracy in the e-commerce sector, setting a benchmark for future research and practical implementations aimed at refining these models for better reliability and accuracy. The findings offer valuable insights for businesses seeking to leverage data analytics for strategic decision-making in an increasingly digital marketplace.*

**Keywords:** Machine Learning, E-commerce Forecasting, LightGBM, Model Explainability (SHAP Analysis), Post-COVID Market Adaptation.

## Personalized Product Recommendations in E-commerce: An Intelligent System Using ALS, SVD, and NMF

Can Erözden<sup>1</sup>, Halil Akgün<sup>1</sup>, Tuna Çakar<sup>2\*</sup>

<sup>1</sup>Insider, Sosyo Plus Information Inf. Tech. Cons. Services Inc., Istanbul, Türkiye

<sup>2</sup>Mef University, Computer Engineering Department, 34396, Istanbul, Türkiye

\*Corresponding author e-mail: cakart@mef.edu.tr

### Abstract

*In the dynamic domain of e-commerce, personalized recommendation systems represent a crucial technology for enhancing user experience and increasing sales. This study introduces a sophisticated recommendation system that leverages User-Based Collaborative Filtering, employing methods such as Alternating Least Squares (ALS), Singular Value Decomposition (SVD), and Non-negative Matrix Factorization (NMF). The system addresses significant challenges such as the "cold start" problem and integrates diverse algorithms to tailor recommendations based on user behaviors, preferences, and contextual factors. As digital commerce continues to evolve, the demand for personalized shopping experiences has intensified. This study focuses on developing an intelligent recommendation system that not only predicts user preferences based on historical data but also improves engagement through targeted recommendations. Utilizing Apache Spark and MLlib, the system processes and analyzes large-scale user interaction data, thereby enhancing the accuracy and relevance of product recommendations. The recommendation system employs a hybrid approach combining ALS, SVD, and NMF models to analyze user-product interaction data, such as views, carts, and purchases. This data is meticulously prepared, normalized, and utilized to train the machine learning models. The system's effectiveness is evaluated using metrics such as Root Mean Square Error (RMSE) and Mean Absolute Error (MAE), alongside live campaign data to gauge real-world engagement and conversion rates. The results underscore the system's capability to deliver personalized recommendations effectively. For instance, the ALS model achieved an RMSE of 6.44 and an MAE of 4.396, indicating a strong predictive performance. Comparative analysis of different models revealed that SVD and SVD++ models performed best, with the lowest RMSE scores of 4.882 and 4.885 respectively. Live campaign analytics further demonstrated the system's impact on user engagement metrics such as click-through and conversion rates. The study highlights the importance of continuous improvement and adaptation in recommendation systems to cater to evolving user needs and technological advancements. It also addresses potential ethical concerns related to bias and privacy, proposing the need for transparent and responsible algorithmic processes. The discussion suggests avenues for future research, including the integration of more diverse data sources and the exploration of hybrid recommendation models. This research contributes significantly to the field of e-commerce by advancing the development of an intelligent recommendation system that not only meets the personalized needs of users but also enhances their engagement with the platform. Future work will focus on integrating cutting-edge machine learning techniques to further refine the recommendations and ensure the ethical use of consumer data*

**Keywords:** Personalized Recommendation Systems, Collaborative Filtering, User Engagement Metrics, Apache Spark and MLlib, Ethical AI Considerations



**Neural Network-Enhanced Analysis of Advection-Dominance Including Dispersivity in Physical Perspective**

**Hande Uslu Tuna<sup>1\*</sup>, Murat Sari<sup>2,3</sup>, Tahir Cosgun<sup>4</sup>**

<sup>1</sup>Yildiz Technical University, Mathematics Department, İstanbul, Türkiye

<sup>2</sup>Department of Mathematical Engineering, Istanbul Technical University, Maslak, 34469, Istanbul, Türkiye

<sup>3</sup>Istanbul Technical University of Northern Cyprus, 99450, Famagusta, Cyprus

<sup>4</sup>Department of Mathematics, Amasya University, Ipekkoy, 05100, Amasya, Türkiye

\*Corresponding author e-mail: usluh@yildiz.edu.tr

***Abstract***

*The examination of advection and dispersion interactions in natural systems, particularly when advection dominates, is crucial due to the essentiality for accurately modelling physical phenomena in fields such as atmospheric science, environmental engineering, hydrology and so on. Traditional analytical and numerical approaches frequently encounter limitations, including difficulties in accurately modelling intricate behaviours and high computational costs. The ability of neural networks to model complex relationships and to learn from large datasets enables a deeper discovery and better simulation of these interactions. Hence, in this study, the efficiency of employing deep neural networks to a third-order dispersive partial differential equation that incorporates advection and dispersion terms has been explored to show that deep neural networks adeptly capture scenarios within physical processes where especially advection plays a dominant role. Several numerical examples have been provided to verify the effectiveness and efficiency of the proposed approaches in analysing advection-dominated processes. The results have revealed that advection dominance is intricately associated with nonlinear dynamics that physics-informed neural networks have proven effective in explaining the relationships within such complexities.*

**Keywords:** Advection Dominance, Dispersion, Nonlinear Dynamics, Physics Informed Deep Neural Networks

**Boyut İndirgeme Tekniklerinin Eğitim Başarısının Matematiksel Modellemesindeki Etkileri**

**Filiz Kanbay<sup>1</sup>, Zeynep Bakan<sup>1\*</sup>**

<sup>1</sup>Yıldız Teknik Üniversitesi, Matematik Anabilim Dalı, 34220, İstanbul, Türkiye

\*Sorumlu yazar e-mail: zeyno@hotmail.com

Bu çalışma, Yıldız Teknik Üniversitesi Bilimsel Araştırma Proje Koordinatörlüğü'nün FYL-2024-6152 numaralı projesi ile desteklenmiştir.

**Özet**

*Sağlık, medya, bankacılık ve finans alanında sınıflandırma, kümeleme ve tahmin amacıyla kullanılan makine öğrenmesi günümüzde eğitim alanında da kullanılmaktadır. Literatürde makine öğrenmesinin öğrencilerin eğitim başarılarına etki eden faktörlerinin incelendiği birçok çalışma vardır. Bu çalışmada UCI veri tabanı sitesinden "Yükseköğretim Öğrencileri Performans Değerlendirme (Higher Education Students Performance Evaluation)" adlı 33 öznitelikli (31 öznitelik kullanılmıştır), 8 sınıf etiketli 145 bilgi içeren ve kayıp verisi bulunmayan veri seti kullanılarak matematiksel modellemeler kurulmuştur. K- en yakın komşu, naive bayes, rastgele orman, destek vektör makineleri, karar ağacı, boosting makine öğrenmesi sınıflandırma algoritmaları ile kurulan matematiksel modellemeler ile öğrencilerin akademik başarılarını etkileyen faktörler araştırılmıştır. İlgili modelleri kurmak için 31 özniteliğe 0-1 dönüşümü uygulanarak 31 öznitelik 116 alt\_özniteliğe dönüştürülmüş ve 8 sınıf etiketli veri seti 3 ve 2 sınıf etiketine indirgenmiştir. Tüm algoritmalar için 116 alt\_öznitelik ve 3 farklı (8,3,2) sınıf etiketi olmak üzere incelenmiş; sonrasında öznitelik sayısını azaltmanın model performans ölçütü üzerindeki etkilerini belirleme maksadı ile denetimsiz ve denetimli algoritmalar (PCA, NCA) kullanılarak sonuçlar özetlenmiştir.*

**Anahtar Kelimeler:** Makine Öğrenmesi, Sınıflandırma Algoritmaları, Denetimsiz Algoritmalar, Eğitim-Öğretim

**An Empirical Analysis of Stock Price Prediction Using Deep Learning Methods: Lstm, Gru, Gan, and Wgan-gp**

**Cemal Öztürk<sup>1\*</sup>, Abdulkadir Karacı<sup>2</sup>**

<sup>1</sup>Pamukkale University, Faculty of Economics and Administrative Sciences, Department of Economics, 20160, Denizli, Türkiye

<sup>2</sup>Samsun University, Faculty of Engineering, Department of Software Engineering, 55420, Samsun, Türkiye

\*Corresponding author e-mail: cemalo@pau.edu.tr

**Abstract**

*Financial markets are essential due to constantly changing economic conditions and global interactions. Accurately predicting stock prices is crucial for investors and financial analysts. This study aims to conduct an empirical analysis using deep learning methods such as LSTM (Long Short-Term Memory), GRU (Gated Recurrent Unit), GAN (Generative Adversarial Networks), and WGAN-GP (Wasserstein Generative Adversarial Networks with Gradient Penalty) to forecast stock prices. The study's objective is to evaluate the performance and limitations of these methods and determine their applicability in financial forecasting by comparing them with the existing literature. The study contributes to the existing literature and presents new approaches in this context. Google stock is used in the study, and it includes daily closing price data between 22.03.2018 and 21.03.2023. This dataset is used for deep learning models, with 70% for training and 30% for testing. The study conducts stock price forecasts using LSTM, GRU, GAN, and WGAN-GP deep learning models. According to the findings, the LSTM model demonstrates the best performance, while the GAN model exhibits the second-best performance. The GRU model shows performance after LSTM and GAN, whereas the WGAN-GP model has the lowest performance. In these models, significant gaps started to form between the actual prices and predictions in 2020 due to an unexpected event caused by COVID-19. This indicates that such models may struggle to cope with unexpected events. The study reveals that it is possible to make accurate predictions using deep learning models for stock price forecasting; however, their sensitivity to unexpected events needs improvement. In conclusion, the study specifically found that LSTM and GAN models are applicable for short-term and medium-term forecasts. The study recommends testing deep learning models on broader financial datasets and different stock markets and conducting more comprehensive trials for sensitivity analysis and hyperparameter optimization. Furthermore, it emphasizes the need for research on integrating fundamental and technical analysis data, macroeconomic factors, and market sentiment analysis into deep learning models. In this way, future studies aim to contribute to developing more effective and reliable financial forecasting models.*

**Keywords:** Deep Learning, LSTM, GRU, GAN, WGAN, Stock Price Prediction



## Unveiling Airline Customer Sentiments: A Data-Driven Journey with Web Scraping and Logistic Regression Analysis

**Cemal Öztürk**<sup>1\*</sup>

<sup>1</sup>Pamukkale University, Faculty of Economics and Administrative Sciences, Department of Economics, 20160, Denizli, Türkiye

\*Corresponding author e-mail: cemalo@pau.edu.tr

### ***Abstract***

*This study offers an in-depth analysis of airline customer evaluations, utilizing the web scraping method to collect data from the Airline Quality website. The dataset was subsequently analyzed using a logistic regression model, a commonly used statistical tool for predicting binary outcomes. The dataset comprises several categories of evaluations, such as seat comfort, cabin staff service, food & beverages, inflight entertainment, ground service, wifi & connectivity, value for money, and recommendations. The recommended feature, indicating the recommendation status, was transformed into a binary format, and the dataset was balanced to ensure accuracy. The performance of the logistic regression model was evaluated using a confusion matrix analysis, which confirmed an accuracy rate of 94.45%. The findings of this study demonstrate the efficacy of web scraping in creating datasets for academic research and the utility of logistic regression models for analyzing customer evaluations and predicting recommendation likelihood in the airline industry. Overall, this study presents a practical approach to assessing customer satisfaction in the airline industry. This approach can be generalized to broader datasets and other airline companies. The results have significant implications for airline managers and policymakers, who can use this method to identify areas for improvement and enhance customer satisfaction. This research contributes to the literature on customer satisfaction and provides a framework for future studies.*

**Keywords:** Machine learning, logistic regression, web scraping, classification methods.

## Deep Learning for Pneumonia Diagnosis: A Comparative Study and Decision Support Interface Implementation

Sena Göksu Ağaca<sup>1\*</sup>, Elif Çiğdem Keleş<sup>2</sup>

<sup>1</sup>Yeditepe University, Graduate School of Natural and Applied Sciences, Data Science, 27470, Istanbul, Türkiye

<sup>2</sup>Yeditepe University, Faculty of Medicine, Department of Biostatistics and Medical Informatics, 27470, Istanbul, Türkiye

\*Corresponding author e-mail: senagoksu.cansabuncu@std.yeditepe.edu.tr

### Abstract

*Pneumonia is a significant public health issue worldwide, leading to high mortality rates. For a definitive medical diagnosis of pneumonia, lung X-ray images must be examined by a physician. Enhancing the diagnostic process with advanced tools can significantly reduce the time doctors spend on each case, thereby increasing their efficiency. This study leveraged convolutional neural network (CNN) architecture from deep learning techniques using chest radiography data. In the first phase of this study, seven different pre-trained transfer learning models were used: InceptionV3, VGG16, VGG19, ResNet50, ResNet50V2, Efficient Net, and MobileNetV2, using a dataset of more than 30,000 anonymized chest X-ray images from the National Institutes of Health (NIH). Among these models, VGG-19 has the highest result and obtains the following result: Validation AUC (0.91), F1-score (0.77), Precision: (0.77), Recall: (0.77). To enhance the model's robustness and consider the higher incidence of pneumonia in children, data from 5,840 children aged 1 to 5 years from NIH's Generalist Repository Ecosystem Initiative (GREI) were also examined. The same VGG19 model was applied to the pneumonia dataset for children, resulting in a validation AUC:(0.90), precision:(0.91), recall: (0.985), and f1-score: (0.89). Before combining both datasets, due to the presence of high-quality and low-quality images in the DICOM dataset, low-quality images were segregated using clustering algorithms. To create a more comprehensive and high-quality model, only the high-quality DICOM data is combined with the children's X-ray image data, and the VGG-19 model is applied. Various techniques like data augmentation are applied to improve the model's performance and its generalization ability to new data for combined datasets. Final model result was validation AUC:(0.91), Precision:(0.89), Recall: (0.88) and f1-score: (0.88). This study was conducted using the Python language on the "Google Colab" tool. Additionally, with the final model, there is a user-friendly interface that allows users to upload real-time chest X-ray data in PNG format and test whether they have pneumonia or not. The interface created using this method is expected to contribute to this purpose.*

**Keywords:** (Deep learning, Convolutional Neural Network, Transfer Learning, DICOM, Decision Support for Pneumonia)

**Forecasting Stock Volatility Via Hybrid Deep Learning and Garch Family Models a  
Case Study From Bist30**

**Yasemin Ulu**<sup>1\*</sup>

<sup>1</sup>Eastern Michigan University, USA

\*Corresponding author e-mail: yasemin.ulu@gmail.com

***Abstract***

*In this study we construct combination of different Deep Learning and GARCH type models to forecast the volatility of 30 stocks that compose the BIST30, Turkish Stock Market Index covering a period of Covid-19 crises. Specifically, we utilize the Bi-Directional Long-Short Term Memory (BiLSTM) model, Long-Short-Term Memory (LSTM) that utilizes forecast from conventional GARCH models to forecast stock volatility for the BIST30. We find that hybrid models that utilize deep learning and GARCH forecasts perform better in forecasting volatility of the stocks considered.*

**Keywords:** *Deep Learning, Long-Short Term Memory, Bi-Directional Long-Short Term Memory, GARCH*





**Bulanık Regresyon ve Makine Öğrenme Algoritmalarının Risk Yönetimindeki Rolü:  
Sağlık, Tarım ve Proje Yönetimi Alanları için Bir İnceleme**

**Derviş TOPUZ<sup>1\*</sup>**

<sup>1</sup>Niğde Ömer Halisdemir University, Niğde Zübeyde Hanım Vocational School of Health Services,  
Department of Health Services Science, 51200, Niğde, Türkiye

\*Sorumlu yazar e-mail: topuz@ohu.edu.tr

**Özet**

Günümüzün karmaşık ve belirsiz dünyasında, veri analizi ve modelleme yöntemlerinin risk yönetiminde kullanımı giderek önem kazanmaktadır. Özellikle sağlık, tarım ve proje yönetimi gibi alanlarda, belirsizliklerle baş etmek ve doğru kararlar almak kritik öneme sahiptir. Bulanık regresyon, belirsiz verilerle çalışırken kullanılan bir regresyon tekniği olarak öne çıkmaktadır. Makine öğrenme algoritmaları ise büyük veri setlerini analiz etmek ve gelecekteki olayları tahmin etmek için güçlü araçlar sunmaktadır. Bu teknikler, belirsizlikleri ele almak, verimliliği artırmak ve doğru kararlar almak için kullanılabilir. Sağlık alanında hastalık risklerini tahmin etmek, hasta yoğunluğu tahminleri, tedavi etkinliği ile planlaması ve hasta memnuniyeti tahminleri gibi çeşitli alanlarda uygulama alanı bulunmaktadır. Tarım alanında verimliliği artırmak veya proje yönetiminde riskleri azaltmak gibi birçok uygulama alanında bulunmaktadır. Bu çalışmada, bulanık regresyon ve makine öğrenme algoritmalarının sağlık, tarım ve proje yönetimi gibi alanlardaki risk yönetimindeki rolü ile örnek uygulamaları incelenmiştir. Ayrıca bulanık regresyonun temel prensipleri, makine öğrenimi ile ilişkisi ele alınmıştır. Bu tekniklerin gelecekteki risk yönetimi uygulamalarında kullanımının daha da yaygınlaşması beklenmekte ve gelecekteki gelişimleri üzerinde durulmuştur.

**Anahtar Kelimeler:** Makine Öğrenme Algoritmaları, Sağlık, Tarım, Proje Yönetimi, Risk Yönetimi

**Aritma Sisteminin Otomasyonu ile Beraber Devreye Alınması**

**Barkın Adıyeke**<sup>1\*</sup>

<sup>1</sup>İzmir Bakırçay Üniversitesi, İzmir, Türkiye

\*Sorumlu yazar e-mail: 6017020@bakircay.edu.tr

**Özet**

*Projemde kullanmayı düşündüğüm s7-1200 ya da s7-1500 grubundan plc ve gerekli I/O Modülleri, Siemens TIA PORTAL üzerinden çalışma yapılacaktır I/O listesi hazırlanıp gerekli bağlantılar yapıp sistemin devreye alınması amaçlanacaktır.*

**Anahtar Kelimeler:** Devreye alma, plc, I/O



**Perakende Sektöründe Faaliyet Gösteren Bir Firma için Ürün Yerleşim Düzeni  
Belirlenmesi**

**Ayşe Hümevra Akar<sup>1\*</sup>, Salih Tekin<sup>1</sup>**

<sup>1</sup>Tobb Etu University

\*Sorumlu yazar e-mail: aysehumevraakar@etu.edu.tr

**Özet**

*Perakende sektöründe son dönemde yaşanan rekabet nedeniyle mağazaların verimli bir şekilde yönetilmesi ve bu sayede gelirlerin artırılması şirket rekabet gücü açısından son yıllarda önemli hale gelmiştir. Raf alanı tahsisi ve ürün teşhiri, karı en üst düzeye çıkarmak, stok kontrolünü geliştirmek, müşteri memnuniyetini artırmak vb. amacıyla perakende ürünlerinin raflarda verimli bir şekilde düzenlenmesi önem taşımaktadır. Bu çalışmada üretimde maliyeti en aza indirmek amaçlanırken hizmet sektöründe müşterinin memnuniyetinin artırılması hedeflenmektedir. Perakende sektöründe faaliyet gösteren bir süpermarketin gerçek verileri kullanılarak model şekillendirilmiştir. Market sepet verilerinden ilgili ürün grupları tanımlanarak ve bir yakınlık matrisi oluşturulacaktır. Bu matris stokastik simülasyon, blok düzeninin karşılaştırılması için bir temel oluşturacaktır. Simülasyon modeli, anlık satın alma oranlarını ve konum etkilerini dikkate alacak şekilde oluşturulacaktır. Daha sonra mevcut düzeni geliştirmek için buluşsal yöntemler, özellikle hem tek hem de çok amaçlı modeller için yapıcı bir buluşsal yöntem ve tabu araması uygulanacaktır. Çalışmanın iki aşamada gerçekleştirilmesi planlanmıştır. İlk olarak anlık satın alma oranlarını dikkate alarak stokastik simülasyon kullanarak mağaza düzeninin karakterizasyonu ve ikinci olarak mağaza düzeninin, alan gereksinimleri, gelir ve departman yakınlıkları dikkate alınarak Tabu Arama Algoritması ile optimizasyonu.*

**Anahtar Kelimeler:** Optimizasyon, En İyileme, Tabu Araması, Market Yerleşim Sorunu, Simülasyon Modeli, Simülasyon, Perakende Sektörü, Anlık Satınalma, Raf Alan Tahsisi



**A Novel Lifetime Q-distribution: Modeling, Properties, and Parameter Estimation**

**Nurgül Okur<sup>1\*</sup>, Kaoubara Djong-Mon<sup>1</sup>**

<sup>1</sup>Giresun University, Faculty of Sciences and Arts, Department of Statistics, 28200, Giresun, Türkiye

\*Corresponding author e-mail: nurgul.okur@giresun.edu.tr

***Abstract***

*In this paper, a new  $q$ -distribution within the lifetime distribution framework is proposed. Various properties of the distribution are investigated, including its modeling, shape, moments, and moment generating function. The estimation of distribution parameters is examined, followed by a simulation study to assess the effectiveness of different estimation approaches. These findings offer valuable insights into the application and analysis of this newly proposed lifetime  $q$ -distribution.*

**Keywords:**  *$q$ -Calculus,  $q$ -Modelling, Lifetime  $q$ -Distribution.*



**Symbiotic Search Algorithm Integrated Approach for Parameter Estimation of Kemp  
Q-Binomial Distribution**

**Djong-Mon Kaoubara<sup>1\*</sup>, Nurgul Okur<sup>1</sup>**

<sup>1</sup>Giresun University, Faculty of Sciences and Arts, Department of Statistics, 28200, Giresun, Türkiye

\*Corresponding author e-mail: kaoubaradjongmon@gmail.com

***Abstract***

*The present research concentrates on parameter estimation for discrete distributions, specifically the Kemp  $q$ -Binomial distribution. It utilizes the Symbiotic Organisms Search Optimization technique, which is a metaheuristic approach. The study contrasts the application of Maximum Likelihood Estimation and the method of moments for parameter estimation. Furthermore, it systematically examines the implementation methodology of the latter, highlighting variances from conventional approaches.*

**Keywords:** *Q-Discrete Distribution, Q-Logarithmic Distribution, Maximum Likelihood Estimation, Method of Moments, Symbiotic Search Algorithm*



**On the Q-Analogues of a Special Continuous Distribution**

**Nurgül Okur<sup>1\*</sup>, Kaoubara Djong-Mon<sup>1</sup>**

<sup>1</sup>Giresun University, Faculty of Sciences and Arts, Department of Statistics, 28200, Giresun, Türkiye

\*Corresponding author e-mail: nurgul.okur@giresun.edu.tr

***Abstract***

*In this paper, we propose  $q$ -analogues for a recently discovered continuous distribution. Additionally, we meticulously examine its distributional properties, encompassing its modeling, shape, moments, and moment generating function. Furthermore, we investigate the parameter estimation of this distribution and conduct a simulation study to compare the performance of various estimates. Our findings shed light on the characteristics and potential applications of this emerging continuous distribution and its  $q$ -analogues.*

**Keywords:** *Q-Calculus, Q-Modelling, Continuous Q-Distribution.*





**Parameter Estimation for the Q-multinomial Distribution Utilizing Metaheuristic Optimization Algorithm**

**Djong-Mon Kaoubara<sup>1\*</sup>, Nurgül Okur<sup>1</sup>**

<sup>1</sup>Giresun University, Faculty of Sciences and Arts, Department of Statistics, 28200, Giresun, Türkiye

\*Corresponding author e-mail: kaoubaradjongmon@gmail.com

***Abstract***

*This paper tackles the parameter estimation of the q-trinomial distribution, a variant of the q-multinomial distribution proposed by C. Charalambides. It addresses the challenges of maximizing the likelihood function by employing a metaheuristic optimization algorithm. The feasibility of this task is demonstrated through sequential data generation from the q-multinomial distribution.*

**Keywords:** *Q-Discrete Distributions, Q-Multinomial Distribution, Q-Parameter Estimation, Maximum Likelihood Estimation, Metaheuristic Optimization Algorithm*



## Advantages of Finite Element Analysis Applications in Wood Material Production and Use

**Göksu Şirin**<sup>1\*</sup>

<sup>1</sup>Tokat Gaziosmanpaşa University, Almus Vocational School, Department of Forestry and Forest Products, 60150, Tokat, Türkiye

\*Corresponding author e-mail: goksu.sirin@gop.edu.tr

### ***Abstract***

*Wood can be characterized as a natural, cellular, polymer-based, hygrothermal viscoelastic material. Wood is widely employed, due to specific properties. In order to use wood in the most appropriate way, its mechanical behavior must be known. Mechanical properties are complex and usually determined by laboratory experiments. Natural and environmental factors affecting the mechanical behavior of wood, an anisotropic material, can make research difficult. Studies of wood from a micro to a macrolevel are necessary for a more precise definition and understanding of material and mechanical behavior of wood. Today, numerical approaches are used for many practical engineering problems for which exact solutions cannot be obtained. Finite Element Method (FEM) is a numerical method used in engineering to analyze the behavior of materials or systems against external factors. In recent years, FEM has become a common technique used in analyzing physical phenomena and solving problems in the field of solid and fluid mechanics. Continuous improvement of the quality and reliability of computers ensures their widespread use in industrial areas. There are many computer programs that use FEM. The main postulate of FEM is that complex domains can be discretized and represented by an assembly of simpler finite sized elements. Numerical modeling of complex structures and complex materials with FEM is increasingly used in stress analysis and failure modelling. Many studies have been carried out by modeling the anisotropic structure of wood from nanometric level to larger dimensions to analyze its mechanical behavior. According to the data obtained from these studies, the simulation results match well with the actually observed results. Analysts have available to them a broad range of modeling concepts that can be applied to wood components and implemented via FEM. The most important factors are that the capabilities of each modelling concept are known and that an appropriate choice is made for the problem at hand. With computation technique developing, numerical simulation becomes an economical and effective way in investigation on wood mechanical property. The basic premise of modern engineering is that models can be used to extrapolate beyond the range of test data. FEM simulations can enable faster, less costly, and more optimized product development. With the fast development of FEM, new perspectives are emerging on problems with complex geometries and loading conditions. To reduce distortions in materials and improve existing ones, FEM is a powerful adjunct that has to be allied with experimental observation and material characterization.*

**Keywords:** Wood Material, Experimental Analysis, Finite Element Analysis

## Modeling Different Types of Claims in Canadian Automobile Insurance

**Pervin Baylan<sup>1\*</sup>, Neslihan Demirel<sup>1</sup>**

<sup>1</sup>Dokuz Eylul University, Faculty of Science, Department of Statistics, 35390, Izmir, Türkiye

\*Corresponding author e-mail: pervin.baylan@deu.edu.tr

### ***Abstract***

*The use of statistical modeling in actuarial science enables the integration of risk factors into the premium pricing process, thereby enhancing the accuracy of insurance premiums and mitigating the financial risk for insurers. One way of preventing unfairness among the policyholders in the premium computation is to consider the claim costs as well as the number of claims. Allowance for the severity of claims can indirectly be provided by subdividing claims into more than one type of claim as property damage (PD) and bodily injury (BI). This study presents a statistical analysis assessing the impact of various risk factors on incurred losses for different types of claims under third-party liability (TPL) insurance in private passenger vehicle accidents. Using automobile insurance data in Ontario, Canada for the decade years period between 2003 and 2012, the statistical models of PD and BI claims are explored via a subject-specific random intercept effect model by considering the imbalance between the classes of insureds. The results indicate that several risk factors — class, modifier, claims history, and time — have a significant impact on the incurred PD losses. For BI claims, the risk factors that are correlated with change of the incurred losses are class, rate modifier, gender, valuation year, and time, observed their effects under the heterogeneity of residual variances between the class groups. The performance metrics,  $R\text{-squared} = 0.7779$  for the PD claims, and  $R\text{-squared} = 0.7157$  for the BI claims, verify the ability of models to accurately predict the incurred losses. The other metrics also support that these models perform well in the prediction. The statistical modeling employed in this study provides information about the risk characteristics of the policyholders crucial for determining the basic premium. The findings of the analysis can assist insurers in creating risk-mitigation strategies that are more accurate and effective.*

**Keywords:** *Subject-Specific Random Intercept Effect Model, Linear Mixed Model, Third-Party Liability Insurance, Unbalanced Panel Data*



**PID Controller Design and Control for Inverted Pendulum System Using PSO  
Algorithm**

**Daryoush Vakili<sup>1\*</sup>, Sıtkı Öztürk<sup>1</sup>**

<sup>1</sup>Kocaeli University, Faculty of Engineering, Electronics and Communication Engineering, 41380,  
Kocaeli, Türkiye

\*Corresponding author e-mail: daryoush.vakili@gmail.com

***Abstract***

*In this study, the position control of the inverted pendulum system, which is one of the control systems examples, was carried out in the MATLAB/Simulink environment. The inverted pendulum system consists of a trolley that can move on the horizontal axis with a servo motor, an encoder that provides position information, and a rod connected to the encoder as a reverse pendulum. The mathematical model of the system was created in the MATLAB/Simulink environment and added to the simulation model. In the simulation model, position control was carried out on the system using the PID controller. The particle swarm optimization (PSO) method was used to determine PID gain values. PID gain values obtained with this method enabled the system to achieve the desired performance. Additionally, this study aims to evaluate the success of the particle swarm optimization (PSO) algorithm in the position control of the inverted pendulum system and also analyze the performance of the PID controller.*

**Keywords:** Inverted Pendulum System, PID Control, Position Control, Particle Swarm Optimization

**Simülasyonla Yüksek Boyutlu Verilerde Eksik Veri Problemini Ele Alan Literatürlerin  
İncelenmesi**

**Buğra Varol<sup>1\*</sup>, İmran Kurt<sup>2</sup>, Mevlüt Türe<sup>2</sup>**

<sup>1</sup>Adnan Menderes Üniversitesi, Sağlık Bilimleri Enstitüsü, Biyoistatistik Bölümü, 09100, Aydın,  
Türkiye

<sup>2</sup>Adnan Menderes Üniversitesi, Tıp Fakültesi, Biyoistatistik Bölümü, 09100, Aydın, Türkiye

\*Sorumlu yazar e-mail: bugravarol87@gmail.com

**Özet**

*Yüksek boyutlu veriler bilimsel araştırmaların önemli bir parçası haline gelmiştir. Ancak, bu verilerin analizi sırasında karşılaşılan en yaygın sorunlardan biri, eksik değerlerin varlığıdır. Klasik eksik veri değer atama yöntemlerinin birçoğu, teorik yapıları nedeniyle yüksek boyutlu verilere doğrudan uygulanamadığı için yüksek boyutlu verilerdeki eksik veri problemi daha karmaşık bir konu haline gelmiştir. Literatürde yer alan modern analitik yaklaşımları klasik tekniklerle bütünleştiren ve çoklu değer atama teorisine dayanan yöntemler, giderek artan bir önem kazanmaktadır. Bu çalışma, yüksek boyutlu veri setlerindeki eksik veri probleminin çözümüne yönelik literatürde yer alan çoklu değer atama yöntemlerinin simülasyonlarla ele alındığı farklı bakış açılarının detaylı incelenmesini amaçlamaktadır.*

**Anahtar Kelimeler:** Yüksek boyut, Eksik veri, Çoklu değer atama, Düzenleştirilmiş regresyon

## Türkiye’de Hayvan Haczi Konu Olan İcra Dosyalarının Ortalama Görülme Süresi Tahmini

Ayşe Yener<sup>1\*</sup>, Aytaç Akçay<sup>2</sup>

<sup>1</sup> Ankara Üniversitesi, Sağlık Bilimleri Enstitüsü, Biyoistatistik Anabilim Dalı, 06070, Türkiye, Ankara

<sup>2</sup> Ankara Üniversitesi, Veteriner Fakültesi, Biyoistatistik Anabilim Dalı, 06070, Türkiye, Ankara

\*Sorumlu yazar e-mail: aysekucuk22@gmail.com

### Özet

*İcra ve iflas hukukunda alacağını borçludan tahsil edemeyen alacaklı için kanun haciz yoluyla takip yolu öngörmüştür. İcra hukukunda yük, binek, arazi hayvanı ve belirli bir ticari değer biçilebilen hayvanlar haczedilebilir olduğu belirtilmiştir. İcra dairelerinde hayvan haczi genellikle borçlunun belirli bir süre içinde borcunu ödemediği durumlarda gerçekleştirilir. Hayvan haczi konu olan icra dosyaları, borçlunun sahip olduğu hayvanları (örneğin, sığır, koyun, keçi gibi büyükbaş veya küçükbaş hayvanlar) borcun tahsil edilmesi amacıyla haczedilmesini içerir. Bu çalışmada icra dairelerinde hayvan haczi olan dosyalarda ortalama görülme süresinin sağkalım analizi yöntemleri ile tahmin edilmesi çalışılmıştır. Yöntem olarak Sağkalım analizi yöntemleri (yaşam tablosu, kaplan – meier ve cox regresyon analizi) kullanılmıştır. Çalışma materyalini, Adalet Bakanlığı birimlerinden olan Adli Sicil ve İstatistik Genel Müdürlüğü'nün uhdesinde yer alan Adalet İstatistiklerini Derleme ve Değerlendirme Daire Başkanlığı tarafından; UYAP'ta tutulan kayıtlar ile oluşturulan "Adli Veri Bankası" kapsamındaki ekranlardan 2012-2023 tarih aralığına dair elde edilen mevcut veri ile hazırlanan hayvan haczi konu olan dosya sayıları oluşturmuştur. Veri seti il, dosya sayısı, dosya açılış tarihi, dosya kapanış tarihi, toplam alacaklı sayısı, takip durdurma durumu, covid dönemi değişkenlerini içermektedir. İlgilenilen olayda dosyanın açılmasından itibaren kapanmasına kadar geçen süre sağkalım zamanını ifade eder ve dosya verilerinin dosya süresi üzerindeki etkisi incelenmiştir. Çalışma sonucunda, konu olan tüm icra dosyaların açıldığı illere göre haritalandırma yapılmış coğrafi dağılımı değerlendirilmiş en çok konya ilinde açıldığı görülmüştür. Hayvan haczi içeren dosyaların ortalama görülme süresi 1.423 gün güven aralığının ise 1.290 ile 1.555 gün aralığında olduğu görülmüştür. Ortalama görülme süresine etki eden değişkenlerin ise covid döneminde olması, takibinin durdurulmuş olması ve alacaklı sayısı değişkenleri görülmüştür. Sonuç olarak, hayvan haczi konu olan icra dosyalarının sayılarının ortalama görülme süresinin tahmini ve ortalama görülme sürelerine etki eden değişkenler çalışılmış ve sunulmuş ticari bir faaliyet olan hayvancılık sektörünün ve yetiştiricilerin ekonomik göstergelerinden olan haciz konusu değerlendirilmiştir.*

**Anahtar Kelimeler:** İcra, Hayvan Haczi, Adli İstatistikler, Kaplan-Meier Analizi, Cox Regrsyon



## Prediction of Milk Yield in Water Buffaloes (*Bubalus Bubalis*) by Genomic Models

Yunus İnan<sup>1</sup>, Burak Karacaören<sup>1\*</sup>

<sup>1</sup>University of Akdeniz, Faculty of Agriculture, Animal Science, 07070, Antalya, Türkiye

\*Corresponding author e-mail: burakkaracaoren@akdeniz.edu.tr

### *Abstract*

*The primary objective of animal production is to achieve the highest possible economic gain from animals referred to as farm animals, which are utilized for their productivity. Therefore, in animal breeding, accurate calculation of breeding value is essential to obtain genetic gain. Conditional on advancements in technology, breeding value estimations now incorporate measurements obtained through molecular genetic methods. The identification of gene loci can be utilized in animal breeding studies through genomic selection or marker-assisted selection methods to bring about economic benefits. The main objective of this study is to investigate the genetic architecture of milk yield phenotype collected from water buffaloes and to predict phenotypes and associated genes using various genomic prediction methods. Milk yield phenotypes from 619 Mediterranean Italian breed buffaloes (corrected for environmental and genetic effects) and a total of 61793 SNP analyses were utilized in this study. Analyses were conducted using methods such as BayesA, BayesB, BayesC( $\pi$ ), Bayesian Lasso, ridge regression, random forest, including Neural networks, Reproducing Kernel Hilbert spaces (RKHS), and Bayesian networks. The success of these methods was assessed using criteria such as Pearson, Kendall, and Spearman correlation coefficients, mean squared errors, and determination coefficients. In terms of accuracy, BayesA, BayesB, Bayesian Ridge Regression, and RKHS exhibited the highest accuracy in predicting phenotypes, all achieving correlations around 0.30. The accuracy levels of machine learning methods used in this study were observed to be comparable to or superior to other methods. For example, support vector regression (SVR) achieved a correlation of 0.3003, while random forest regression (RFR) achieved 0.2875 in predicting observations. Multidimensional scaling analysis revealed stratification among genotypes. To avoid erroneous genomic relationships, genomic relationship analysis was performed after correcting phenotypes with both genomic pedigrees and genomic principal components. The strongest genomic signals associated with milk yield were identified on chromosomes 1, 2, 4, 11, and 19. This study was supported by Scientific and Technological Research Council of Turkey (TUBITAK) under the Grant Number 118O108. The authors thank to TUBITAK for their supports.*

**Keywords:** *Genomic selection, genomic prediction, water buffalo, milk yield*

**Comparison of Methods Affecting Classification Performance on Imbalanced Data Sets**

**Saliha Demirsöz<sup>1\*</sup>, Harun Yonar<sup>1</sup>**

<sup>1</sup>Selçuk University, Faculty of Veterinary Medicine, Department of Biostatistics, 42250, Konya, Türkiye

\*Corresponding author e-mail: elmacisalaha5@gmail.com

***Abstract***

*Imbalanced data occurs when one or more classes are represented much more or less than others. When the class distribution is not close to each other, the prediction model for the classes is accurate for the majority, but the model is not suitable for predicting the minority class. In the case of imbalanced data, potential problems such as affecting the reliability of statistical inferences and bias may occur. Solutions have been developed with alternative methods for the imbalanced data problem, which especially affects the performance of machine learning algorithms. In this study, using published data for classification problems, the contribution of over-sampling methods to classification performance was comparatively carried out through various performance metrics.*

**Keywords:** *Imbalanced Data, Machine Learning Algorithms, Classification Problem, Oversampling Methods*



**Random Walk Hypothesis and Econometric Modelling of It Stocks in the Indian Stock Market**

**Rita Samikanu<sup>1</sup>, Mihir Dash<sup>1,2\*</sup>**

<sup>1</sup>Department of Statistics, Periyar University, India

<sup>2</sup>School of Applied Mathematics, Alliance University, Chikkahagade Cross, Anekal, Bangalore, India, 562106

\*Corresponding author e-mail: mihirda@rediffmail.com

***Abstract***

*The Random Walk Hypothesis (RWH) suggests that changes in stock prices should not follow any pattern, i.e. stock price movements should be random. The pioneering works of Cowels (1933) and Working (1934) were followed by renewed interest in the 1960s, with the work of Osborne (1959), Alexander (1961), Cootner (1962), Fama (1966), Evans (1968), Smidt (1968), and Jensen and Benington (1970). The nonparametric runs test was the usual approach to test the RWH in early studies; however, this approach had the limitation of low power. In fact, several studies have shown short-run autocorrelation in stock prices (e.g. Lo and MacKinley, 1999). This study examines the RWH for twenty major stocks from the Indian IT sector. The stock price data was collected from the National Stock Exchange (NSE) of India. The study period considered is 2010-24. The study uses a series of econometric models, including the runs test, normality tests, dummy variable regression, the ADF test for stationarity, ARMA(1, 1) model, GARCH(1, 1) model, AR(1)-GARCH(1, 1) model, Hurst exponent, and Lyapunov exponent for stock returns to test the RWH. These approaches examine different aspects of deviation from the RWH.*

**Keywords:** *Random Walk Hypothesis, Runs Test, ADF Test, Normality Tests, AR modelling, GARCH Modelling, AR-GARCH Modelling, Hurst Exponent, Lyapunov Exponent*



**Insurance and Financial Development, a Panel Data Analysis**

**Aylin Mercan Alkan<sup>1\*</sup>, Ali Köse<sup>2</sup>**

<sup>1</sup>Tokat Gaziosmanpaşa University, Turhal Faculty of Applied Sciences, Banking and Insurance,  
60000, Tokat, Türkiye

<sup>2</sup>Marmara University, Faculty of Financial Sciences, Actuary, 34000, İstanbul, Türkiye

\*Corresponding author e-mail: aylin.mercan@gop.edu.tr

***Abstract***

*Concretizing the place and importance of insurance companies within financial systems is important in order to increase the value and quality of insurance in Turkey. As a matter of fact, more than 90% of the financial sector consists of the banking sector. However, insurance companies are an important resource and fund provider for the development and sustainability of financial markets. For this reason, the size of the insurance sector can have the power to directly affect the country's economy and development. The aim of the study is to analyze the relationship of the insurance sector, whose value and importance is increasing within the financial services sector, with financial development in country groups classified according to their development level. It is aimed that the study will be beneficial both for the sector and scientifically in terms of reflecting the demands and needs of the sector, understanding the value of the insurance sector, and showing what place a developed insurance sector has in the financial services sector. In the study, financial development index data published by the IMF was used as a financial development indicator. Panel causality analysis method was applied for 81 countries between 1980-2023. According to the analysis results, it was revealed that there is a bidirectional and positive causality relationship between insurance and financial development.*

**Keywords:** Insurance, Financial Development, Panel Data Analysis, Panel Causality Test

## The Relationship Between Development of the Insurance Sector and Environmental Quality

**Sibel Ölmez Cangı<sup>1\*</sup>, Aylin Mercan Alkan<sup>1</sup>**

<sup>1</sup>Tokat Gaziosmanpaşa University, Turhal Faculty of Applied Sciences, Banking and Insurance, 60000, Tokat, Türkiye

\*Corresponding author e-mail: sibel.olmez@gop.edu.tr

### *Abstract*

*While the world is struggling with the problems arising from climate change, the insurance industry is an important player in reducing carbon emissions as a natural stakeholder in the risk management process. The impacts of climate change on the insurance sector have added a new dimension to the sustainability efforts of the insurance industry. The insurance sector plays an important role in combating catastrophic risks such as extreme natural events caused by climate change. In addition to compensating the losses that occur after natural disasters with the indemnities they pay, insurance companies can implement policies that reduce and prevent possible losses with the risk management strategies they determine. Insurance companies' approaches to managing risks related to climate change are linked to policies adopted for reducing carbon emissions and environmental sustainability. By financing renewable energy projects and developing renewable energy insurance products, the Turkish insurance sector can support the reduction of CO<sub>2</sub> (carbon dioxide) emissions and increase the sustainability of the sector. This study aims to analyze the relationship between the Turkish insurance sector and environmental pollution based on the relationship between carbon emissions and renewable energy consumption. In the study, a time series analysis was conducted using data on carbon emissions, renewable energy consumption and insurance premiums in Turkey between 1990 and 2022. According to the results of the analysis, a negative relationship was found between the development of the Turkish insurance sector and environmental pollution.*

**Keywords:** *Key words: Insurance, CO<sub>2</sub> emissions, Climate Change, Renewable Energy*

**Achieving Competitive Advantage! Do We Only Need Good Financials?**

**Waqas Zaki<sup>1\*</sup>, Muhammad Shehzad Hanif<sup>1</sup>, Aitzaz Khurshid<sup>1</sup>**

<sup>1</sup> University Of Central Punjab, Pakistan

\*Corresponding author e-mail: zaki@ucp.edu.pk

***Abstract***

*Economic performance is not the only source of competitive advantage anymore. Firms need to focus on all three dimensions of sustainability including economic, environmental, and social. We suggest that innovation capability is the starting point for achieving these objectives. Specifically, we have compared the effects of innovation at the strategic and operational levels on the three dimensions of sustainability that lead to the firm's competitive advantage under the RBV-stakeholder theory perspective. PLS-SEM-based results of this study conducted from 410 manufacturing firms in Pakistan validate that process innovation plays a relatively stronger role than strategic innovation in achieving sustainable performance, which leads to varying effects on the firm's competitive advantage. The study holds broad implications for integrating RBV and stakeholder theory, imparts fresh insights for practitioners and concludes by suggesting avenues for future research.*

**Keywords:** Innovation capability; Resource-based View; Economic performance; Social performance; Financial performance, Emerging Market

**Keywords:** Innovation Capability, Resource-Based View, Economic Performance, Social Performance, Financial Performance, Emerging Market



**Development of Decision Support Mechanisms for Innovation Portfolio Management in Defense Industry: A case Study on Tai**

**Zeynep Didar Orhan<sup>1\*</sup>, Zehra Aydın<sup>1</sup>, Aysin Aydın<sup>1</sup>, Sıla Damla Kiliç<sup>1</sup>, Ece Arzu Yıldız<sup>1</sup>,  
Duygu Aktay Kantaroğlu<sup>2</sup>**

<sup>1</sup>Industrial Engineering Department, Faculty of Engineering, Gazi University, Ankara, Türkiye

<sup>2</sup>Turkish Aerospace Industries, Inc. (ta), Ankara, Türkiye

\*Corresponding author e-mail: didarorhan24@gmail.com

***Abstract***

*This study focuses on the development of decision-support mechanisms to aid in managing innovation portfolios in defense industry companies. We have examined the decision-making processes within Turkish Aerospace Industries, Inc. (TA), the leading aerospace company in Türkiye, and developed a solution strategy to address the problems that arise in these processes. At the core of the study lie critical decisions such as technology roadmaps, portfolio management, open innovation activities, and internal entrepreneurship practices. The integration of the Decision Support System (DSS) aims to enhance the effectiveness of decision-making processes. The developed DSS collects and analyzes data with the goal of optimizing and continuously improving decision-making mechanisms in defense industry companies' innovation and R&D processes. The DSS embeds the Step-Wise Weight Assessment Ratio Analysis (SWARA) method to prioritize the identified problems. After that step, solution strategies were formulated. The principle of continuous improvement guided the implementation of these strategies. Accordingly, the solution strategies will be aligned with the company's overall strategies and technology roadmap to not only address identified problems but also contribute to the company's overarching objectives.*

**Keywords:** *Optimization, Decision Support Mechanisms, Multi-Criteria Decision Analysis, Defense Industry, Innovation Portfolio Management.*

**The Impacts of Atmospheric Teleconnections on Potential Evapotranspiration in the Central Anatolia Region, Türkiye**

**Cenk Sezen**<sup>1\*</sup>

<sup>1</sup>Ondokuz Mayıs University, Samsun, Türkiye

\*Corresponding author e-mail: cenk.sezen@omu.edu.tr

***Abstract***

*Detecting variations in hydrometeorological variables is significant for analyzing the effects of climate change and taking precautions against extreme events. In this study, the impacts of northern hemisphere-based atmospheric teleconnections, namely Arctic Oscillation (AO), North Atlantic Oscillation (NAO), and Eastern Atlantic/Western Russia (EAWR) on potential evapotranspiration were investigated in the Central Anatolia Region in Türkiye. The data from five meteorological stations were used for the analysis. In this regard, Spearman's rank correlation coefficients between the atmospheric teleconnections and evapotranspiration were calculated and analyzed annually and seasonally at the significance level  $\alpha=0.05$  for 1980-2016. It was observed that the NAO and evapotranspiration had only significant negative correlations in summer. There is no significant correlation between the NAO and evapotranspiration in other seasons and annually. The relationship between the EAWR and evapotranspiration data is significantly negative, almost in all seasons and annually. The correlations between the AO and evapotranspiration are significantly negative only in the winter seasons. According to the correlation analysis, the effects of EAWR can be more substantial than those of the NAO and AO at seasonal and annual scales.*

**Keywords:** Atmospheric Teleconnections, Climate Change, Correlation, Evapotranspiration, Türkiye

## Geographically Weighted Generalized Log Gamma Regression (GWGLGR) Model

**Sitti Zahirah Nurdin<sup>1\*</sup>, Purhadi<sup>1</sup>, Santi Wulan Purnami<sup>1</sup>**

<sup>1</sup> Institut Teknologi Sepuluh Nopember, FSAD, Statistic, 60111, Surabaya, Indonesia

\*Corresponding author e-mail: zhara.pz@gmail.com

### *Abstract*

*The Generalized Log Gamma (GLG) distribution is a family of 3-parameter Generalized Gamma (GG) distributions. Some of the distributions that belong to the 3-parameter GG distribution family are several asymmetric distributions such as Log Exponential, Log Weibull, Log Gamma and even the Normal distribution as a special case. These distributions are used to model positive data that has a tendency on a logarithmic scale. One of the applications of the GLG distribution is the Generalized Log Gamma Regression (GLGR) model which assumes that the response variable is GLG distributed. However, in area-based research it is possible that there are spatial effects in the form of spatial heterogeneity. The existence of spatial heterogeneity causes global modeling to be less precise, so it is necessary to develop a model. In this study, a generalized log gamma regression model was developed that involved spatial factors with geographic weighting called the Geographically Weighted Generalized Log Gamma Regression (GWGLGR) model. This study uses Maximum Likelihood Estimation (MLE) with Berndt-Hall-Hausman (BHHH) iteration to obtain the estimator of model parameters. After that, get test statistics on the Geographically Weighted Generalized Log Gamma Regression (GWGLGR) model using the Maximum Likelihood Ratio Test (MLRT).*

**Keywords:** BHHH, GG, GLGR, GWGLGR, MLRT.



**Performance Analysis Regarding Climate Change: The Case of Next Eleven Countries**

**Nuray Tezcan**<sup>1\*</sup>

<sup>1</sup>Haliç University, Faculty of Business Administration, Department of Management Information Systems, 345060, Istanbul, Türkiye

\*Corresponding author e-mail: nuraytezcan@halic.edu.tr

***Abstract***

*The Next Eleven (N-11) refers to a group of eleven countries, namely Bangladesh, Egypt, Indonesia, Iran, Mexico, Nigeria, Pakistan, Philippines, Turkey, South Korea and Vietnam, which have emerging markets that could potentially become some of the largest economies in the world. Accordingly, these countries can be considered the leading countries in terms of their energy consumption. The aim of this study is to determine the performance of the N-11 countries in terms of climate change using a multi-criteria decision-making approach. To this end, indicators such as access to clean fuels and technologies for cooking, energy intensity of primary energy, greenhouse gas emissions and renewable energy consumption were extracted from the World Development Indicators database and the Grey Relational Analysis (GRE) method was used. The indicators used were defined on the basis of Sustainable Development Goals (SDGs) 7 and 13, which are related to energy use and climate change. According to the results of the analysis, Bangladesh, Philippines and Egypt were found to be the best performers, while Nigeria, Indonesia and Iran were found to be the worst.*

**Keywords:** *Climate Change, Energy Use, Next Eleven Countries, Grey Relational Analysis*

## Random Regression Analysis for Body Weight in Hair Goats

Yunus İnan<sup>1</sup>, Burak Karacaören<sup>1\*</sup>

<sup>1</sup>University of Akdeniz, Faculty of Agriculture, Animal Science, 07070, Antalya, Türkiye

\*Corresponding author e-mail: burakkaracaoren@akdeniz.edu.tr

### *Abstract*

*Animal breeding and genetic studies utilize profound and complex sources of pedigree information. Accurate estimation of breeding values enables higher genetic advancements. Through random regression analyses, genetic parameters and breeding values associated with body weight phenotype over time can be predicted, facilitating the attainment of more precise breeding values and genetic progress. In this study, 6108 body weight records from 2589 animals were utilized to predict genetic parameters and breeding values associated with body weight phenotype over time using a random regression model. Random regression analysis was conducted using the WOMBAT computer program, incorporating fixed effects (such as dam age, sex, birth type) into the model, and investigating scenarios with homogeneous or heterogeneous variance. The measurement time was defined as a control variable in the analyses, and various random regression models were examined concerning the addition or exclusion of fixed effects, homogeneity or heterogeneity of error variance, and the degree of Legendre polynomial (1, 2, 3), with models being compared based on AIC and BIC values. It was observed that the model with fixed effects and homogeneous variance had lower AIC and BIC values compared to other models. The heritability estimates obtained from this model ranged from 0.20 to 0.49. This study was supported by Scientific and Technological Research Council of Turkey (TUBITAK) under the Grant Number 122O885. The authors thank to TUBITAK for their supports.*

**Keywords:** Hair Goats, Body Weight, Heritability, Breeding Value

## Examination of Diabetes Risk Factors and Diabetes Diagnosis Prediction with Logistic Regression Model

Muzaffer Demir<sup>1</sup>, Fulden Cantas Turkis<sup>2\*</sup>

<sup>1</sup> Muğla Sıtkı Koçman University Faculty of Medicine, 48000, Muğla, Türkiye

<sup>2</sup> Muğla Sıtkı Koçman University Faculty of Medicine, Division of Biostatistics, 48000, Muğla, Türkiye

\*Corresponding author's e-mail: [fuldencantas@mu.edu.tr](mailto:fuldencantas@mu.edu.tr)

### Abstract

*Diabetes is a very serious metabolic disease in which there is more sugar than normal in the human body. According to data announced by the World Health Organization, there are approximately 422 million diabetic patients worldwide. The majority of these patients live in low- and middle-income countries, and 1.5 million deaths each year are associated with diabetes. This study aims to emphasize the risk factors affecting diabetes and the impact levels of these factors. For this purpose, the diabetes data set, which contains  $n = 70692$  units and 18 variables and is freely accessible to researchers, was used. According to the results of univariate and multiple logistic regression analysis, being over 29 years old, male gender, presence of cholesterol, not checking cholesterol at routine intervals, high body mass index, presence of a history of heart disease or attack, lack of physical activity, not consuming vegetables, using alcohol and Having a poor general health score are factors that increase the risk of diabetes. As a result of the ROC curve analysis performed to calculate the performance of the logistic regression model created with these risk factors, it was determined that the prediction model had a high success rate in predicting diabetes and healthy individuals. Considering the results obtained, it was concluded that it would be possible to reduce the risk of the disease without being diagnosed with diabetes by making changes in the lifestyle of an individual who has not yet been diagnosed with diabetes. This lifestyle regulation will contribute to both the health of individuals and the health economy.*

**Keywords:** Logistic Regression, Diabetes, Classification, ROC curve

*This study was supported by TUBITAK project number 1919B012311430.*



**Evaluation of Grant Support Practices Implemented by Agriculture and Rural  
Development Support Institution in Dairy Cattle Farms**

**Abdüssamed Durmuş<sup>1\*</sup>, Gülistan Erdal<sup>1</sup>, Fevzi Çiçek<sup>3</sup>**

<sup>1</sup>Tokat Gaziosmanpasa University, Faculty of Agriculture, Department of Agricultural Economics,  
60250, Tokat, Türkiye

<sup>2</sup>TKDK Tokat Provincial Coordination Office, 60030, Tokat, Türkiye

\*Corresponding author e-mail: durmusabdussamed@gmail.com

***Abstract***

*The aim of this study is to evaluate the effects of the grants provided by the Agriculture and Rural Development Support Institution (ARDSI) to dairy cattle farms in Turkey. For this purpose, the activities of dairy cattle breeding enterprises that were established by benefiting from the Instrument for Pre-Accession Assistance- Rural Development Component I (IPARD I) program implemented between 2011-2016 and developed through this program and reached EU standards were focused on. In the research, the results of the questionnaire surveys conducted with the owners of 307 enterprises that have benefited from IPARD supports implemented throughout Turkey (42 provinces) were evaluated. As a result of the study, it was determined that the demographic profiles and business structures of the enterprises receiving IPARD support varied and that real person enterprises operated by middle-aged men with secondary school graduates were predominant. It can be said that IPARD supports accelerate the investment process of enterprises and increase their production capacity. Although most of the enterprises are satisfied with the support, some of them stated that they faced challenges such as the complexity of the program or high costs. Therefore, it may be recommended to improve the program and make it accessible. In conclusion, IPARD support has an important role in modernizing agriculture and livestock enterprises, increasing their competitiveness and ensuring their sustainability. It is important to continue to work intensively to encourage wider participation in the program and to make it more effective.*

**Keywords:** IPARD I, Dairy Cattle , TKDK

**Determining the Causality Relationship Between Climate Data and Wheat and Barley Yield in Turkey with the Toda-Yamamoto Test**

**Didem Dođar<sup>1\*</sup>, Adnan Çiçek<sup>1</sup>**

<sup>1</sup>Tokat Gaziosmanpasa University, Faculty of Agriculture, Department of Agricultural Economics, 60240, Tokat, Türkiye

\*Corresponding author e-mail: dogardidem@gmail.com

***Abstract***

*The aim of this study is to examine the causality relationship between long-term climate data and wheat and barley yield. The data set of the study covers 53 years of climate data and wheat and barley yields in Turkey between 1970 and 2023. Toda-Yamamoto test was used to determine the causality relationship between temperature, precipitation, humidity, number of snowy days and wheat and barley yield. For this purpose, firstly, the ADF and PP unit root tests of the series were performed and it was determined that the series did not contain a unit root in the first difference. Additionally, it was determined that there was no autocorrelation or heteroskedasticity problem in the series. As a result of the analyses, it was determined that the changes in wheat and barley yield were largely dependent on temperature and humidity changes. It has been determined that there is a one-way causality relationship from temperature, precipitation and number of snowy days to wheat yield at a 1% significance level. Additionally, it was determined that there was a positive relationship between temperature and precipitation and wheat yield, and a negative relationship between the number of snowy days and wheat yield. A one-way causality relationship was determined at the 1% significance level from temperature, humidity and number of snowy days to barley yield. It was determined that there was a positive relationship between temperature and barley yield, and a negative relationship between humidity and the number of snowy days and barley yield. In light of these findings, it is important to analyze the effects of climate factors such as temperature, humidity, precipitation and number of snowy days on agricultural production on a regional scale and to take the necessary precautions for future food security and sustainable agriculture.*

**Keywords:** *Toda-Yamamoto test, Wheat and barley yield, Climate change, Causality analysis, Türkiye*

**Forecast of Buffalo Assets in the TR83 Region and Türkiye for the Next Five Years  
(2024-2028)**

**Samet Hasan Abacı<sup>1\*</sup>, Ertuğrul Kul<sup>2</sup>**

<sup>1</sup>Ondokuz Mayıs University, Faculty of Agriculture, Department of Animal Science, 55139, Samsun, Türkiye

<sup>2</sup>Kırşehir Ahi Evran University, Faculty of Agriculture, Department of Animal Science, 40100, Kırşehir, Türkiye

\*Corresponding author e-mail: samet.abaci@omu.edu.tr

**Abstract**

*Sustainable management and conservation of buffaloes can generally contribute to ecosystem health and human well-being. In Türkiye, there was a significant decline in buffalo populations until 2010, putting them at risk of extinction. However, measures taken since 2011 have led to an increase in buffalo numbers. More recently, fluctuations in buffalo populations have been observed after 2021. This study forecasts buffalo populations for the next 5 years in Türkiye, focusing on the TR83 region, known for its significant buffalo presence. Secondary data from the Turkish Statistical Institute (TURKSTAT) spanning from 2004 to 2023 were used for this research. Due to limited data for forecasting between 2024 and 2028, Brown's linear exponential smoothing method was preferred. Data analysis was conducted using the SPSS package. According to TURKSTAT, Türkiye had 161749 buffaloes in 2023, with 21.9% (35361 buffaloes) in the TR83 region. Analyses indicate an expected decline in buffalo populations in Türkiye by 6.5% to 32.6% between 2024 and 2028 and in the TR83 region by 7.8% to 38.7%. These findings suggest an overall decrease in buffalo populations, emphasizing the importance of taking necessary measures and increasing conservation efforts to sustain the presence of buffaloes, which are significant economically, environmentally, culturally, and genetically.*

**Keywords:** Ecosystem, Sustainability, Buffalo



**The Status and Forecast of Tomato Production in Tokat, Türkiye**

**Nur İlkay Abacı<sup>1\*</sup>, Halil Kızılaslan<sup>2</sup>**

<sup>1</sup>Ondokuz Mayıs University, Faculty of Agriculture, Department of Agricultural Economics, 55139, Samsun, Türkiye.

<sup>2</sup>Tokat Gaziosmanpaşa University, Faculty of Agriculture, Department of Agricultural Economics, 60240, Tokat, Türkiye.

\*Corresponding author e-mail: ilkay.sonmez@omu.edu.tr

***Abstract***

*Tokat, located in Turkey, stands out as one of the provinces with considerable agricultural potential. According to data from the Turkish Statistical Institute (TUIK), vegetable cultivation encompassed 119,971 decares of land in Tokat province during 2023. Notably, 35% of this cultivation was attributed to dry onions, 18.7% to fresh beans, and 15.6% to tomatoes. The objective of this research is to forecast tomato production in Tokat province for the forthcoming five years. To this end, data pertaining to tomato cultivation area and yield within Tokat province spanning from 2005 to 2023 were procured from the TUIK database. Tomato productivity was ascertained by dividing the yield by the cultivated area. The normality assumption of the data was validated through Shapiro Wilk, Skewness, and Kurtosis tests ( $P>0.05$ ). Brown's linear exponential smoothing method was employed for analysis. According to the model results, it is projected that the tomato cultivation area, which stood at 18,741 decares in 2023, will diminish to 10,319.39 decares by 2024, and further decline to 1,269.48 decares by 2025. A negative trajectory in cultivation area is anticipated for the years 2026-2028. In terms of tomato yield, a 43.6% reduction from the preceding year is anticipated for 2024, followed by a staggering 97.8% decline in 2025. The findings underscore a significant downturn in tomato production within Tokat province. Consequently, policymakers and local stakeholders are urged to deliberate on strategies aimed at optimizing cultivation areas and enhancing productivity.*

**Keywords:** *Tomato yield, Production, Forecast, Tokat*

**Consumers' Knowledge, Attitude and Consumption Behavior Regarding Starch-Based Sugar: The Case of Ondokuz Mayıs University Faculty of Agriculture Students**

**Berkay Çevik<sup>1\*</sup>, Kürşat Demiryürek<sup>1</sup>**

<sup>1</sup>Ondokuz Mayıs University, Faculty of Agriculture, Department of Agricultural Economics, 55139, Samsun, Türkiye

\*Corresponding author e-mail: berkay6212@gmail.com

***Abstract***

*The main purpose of the research is to determine consumers' knowledge, attitude and consumption behavior towards starch-based sugar (SBS). In this regard, 234 final students studying at Ondokuz Mayıs University Faculty of Agriculture were determined as the target audience using the complete count method. The research examines the effects of SBS on consumption habits, knowledge level and consumer attitudes through men (66%) and women (34%), who constitute the majority of the participants. The study was conducted through online surveys and the data obtained was analyzed with the SPSS statistical program. Analyzes were supported by descriptive statistics using frequency distribution and percentage. According to the results, 46% of the students expressed the opinion that SBS could cause negative effects on health. This indicator supports participants' tendency to make healthier food choices. However, the study also determined that students were incapable of both defining and recognizing products containing SBS and correctly interpreting label information. These findings highlight the importance of labeling standards so that consumers can make sound decisions about SBS consumption. This study supports consumers in making more conscious and healthy food choices by examining in depth the effects of SBS on consumption habits and health perception. Therefore, it is necessary to carry out awareness-raising efforts to increase consumers' knowledge on this subject and make healthier nutritional choices by providing a broad perspective on the consumption of SBS.*

**Keywords:** *Starch Based Sugar, Consumers, Knowledge, Attitudes and Consumption*

Comparative Analysis of OECD Countries with Respect to R&D and Innovation  
Indicators by Using Machine Learning Algorithms

Gülcan Petriçli<sup>1</sup>, İkbalkavak<sup>2\*</sup>

<sup>1</sup>Bursa Uludağ Üniversitesi, İnegöl İşletme Fakültesi, İşletme Bölümü, Sayısal Yöntemler Anabilim  
Dalı, Bursa, Türkiye

<sup>2</sup>Bursa Uludağ Üniversitesi, İnegöl İşletme Fakültesi, Yönetim Bilişim Sistemleri Bölümü, Bursa,  
Türkiye

\*Corresponding author e-mail: ikbalkavak10@gmail.com

**Abstract**

Research and development (R&D) activities play a crucial role in fostering a nation's economic growth, technical advancement, and increased productivity. This study aims to analyze the OECD and associated countries' innovation and R&D performances in order to support the creation of policies that promote innovation, international collaboration, technology transfer, and information sharing. For this purpose, it attempts to determine country groups and investigate key features that distinguish countries by employing unsupervised machine learning algorithms. It considers the number of R&D employees, the percentage of R&D spending in gross domestic product, the number of patent applications, medium- and high-technology exports, value-added medium-high technology exports, the number of scientific articles, patent applications, and the FRASCATI guide's research activities (basic research, applied research, and experimental development) as clustering features. The analyses were limited to 2019 due to the presence of incomplete observations in numerous indicators for 2020 and beyond. The study was designed using a stepwise approach. The first step used Self-Organizing Maps, which are a special type of artificial neural network, to pre-cluster data. The highest-performing map was identified using the lowest quantization errors. The second step involved hierarchical cluster analysis to cluster the reduced data set. Internal assessment criteria were used to find the most appropriate number of clusters. The Majority Rule was used to determine the optimal number of clusters, and two groups were identified: Turkey, Australia, Estonia, Greece, Latvia, Lithuania, New Zealand, Poland, Portugal, Slovakia, Spain, Russia, and South Africa. The second group consisted of China, the United States, the United Kingdom, Sweden, Slovenia, Norway, and South Korea. Then, Principal Component Analysis was conducted on the pre-clustering outputs to establish the importance levels of features. The three most important features identified were the number of R&D personnel, the proportion of R&D expenditures to gross domestic product, and value-added medium- and high-technology exports. However, the results briefly summarized in this research are not definitive. Rather, the investigation is still ongoing in terms of analysis. To explain, cluster analysis is an unsupervised learning technique. There is no "Golden Rule" for evaluating the outputs of unsupervised learning algorithms. To tackle this issue, it is advisable to conduct the analysis with different algorithms, and the clustering model with the highest performance should be selected as the optimal solution. In conclusion, this study systematically handles the analysis process in a way compatible with the database knowledge discovery process, unlike most of the studies in the literature. This approach will help identify both the weaker and stronger country groupings, the most critical indicators, as well as potential collaborations.

**Keywords:** Data Mining, Cluster Analysis, R&D, Innovation, OECD

This research was funded by the Bursa Uludağ University Scientific Research Project Department [Project ID: 1826].



**Omics Analysis Reveals the Involvement of Carbon and flavonoid Biosynthesis in Low Phosphorus Tolerance in Cotton**

**Asif Iqbal<sup>1\*</sup>**

<sup>1</sup>Department of Agriculture, Hazara University, Khyber Pakhtunkhwa, Mansehra 21120, Pakistan

\*Corresponding author e-mail: dr.asifiqbal@hu.edu.pk

***Abstract***

*Low phosphorus (P) is one of the limiting factors in sustainable cotton production. However, little is known about the performance of contrasting low P tolerant cotton genotypes that might be a possible option to grow in low P condition. In the current study, we characterized the response of two cotton genotypes, Jimian169 a strong low P tolerant, and DES926 a weak low P tolerant genotypes under low and normal P conditions. The results showed that low P greatly inhibited growth, dry matter production, photosynthesis, and enzymatic activities related to antioxidant system and carbohydrate metabolism and the inhibition was more in DES926 as compared to Jimian169. In contrast, low P improved root morphology, carbohydrate accumulation, and P metabolism, especially in Jimian169, whereas the opposite responses were observed for DES926. The strong low P tolerance in Jimian169 is linked with a better root system and enhanced P and carbohydrate metabolism, suggesting that Jimian169 is a model genotype for cotton breeding. Results thus indicate that the Jimian169, compared with DES926, tolerates low P by enhancing carbohydrate metabolism and by inducing the activity of several enzymes related to P metabolism. This apparently causes rapid P turnover and enables the Jimian169 to use P more efficiently. Moreover, the transcript level of the key genes could provide useful information to study the molecular mechanism of low P tolerance in cotton.*

**Keywords:** Cotton, Low Phosphorus Tolerance, Root Morphology, Carbohydrate Accumulation, Phosphorus Metabolism

**Interval Type-2 Fuzzy Quality Control Charts for Sensorial Analysis of Virgin Olive Oil**

**Suzan Kantarcı Savaş<sup>1\*</sup>**

<sup>1</sup>Department of Econometrics, Faculty of Economics and Administration Sciences, Kırklareli University, 39000, Kayali Campus, Kırklareli, Türkiye

\*Corresponding author e-mail: suzan.kantarci@klu.edu.tr

***Abstract***

*Sensorial analysis of virgin olive oil is an important issue to decide the quality of virgin olive oil. The traceability of the sensorial analysis procedure has crucial manner for the accreditation process of sensorial analysis laboratories around the world. In accredited sensory laboratories for olive oil, there are internal and external qualification mechanisms. Quality control charts are not only useful for the product but also useful for the process. These charts provide traceability of the process and/or product. In sensorial analysis laboratory, quality control charts has important issue for interal quality controls. Sensorial analysis of virgin olive oil is related with human sensation. So it is necessary to control the taster and panel situation. The data is collected from olive oil tasters' sensations. Fuzzy logic handles with uncertain information. Because of the sensations, the tasters' data includes uncertainty. Fuzzy statistics can be helpful to deal with vagueness without loss information. For this reason, this study aims to adapt type-2 fuzzy sets and quality control charts procedure defined in standards defined by IOC (Inernational Olive Council). This study includes fuzzy quality control charts presented for each taster and panel, respectively. An experimental study is designed for a panel group. The fuzzy results are compared with the crisp results.*

**Keywords:** *Interval type-2 fuzzy sets, fuzzy quality control charts, sensorial analysis, olive oil.*

## Changes in Household Income and Income Distribution in Agriculture by Years

**Nami Kaan Kızılcan<sup>1\*</sup>, Aysel Ergün<sup>1</sup>, Esen Oruç<sup>1</sup>**

<sup>1</sup>Tokat Gaziosmanpaşa University, Faculty of Agriculture, Agricultural Economics, 60250, Tokat, Türkiye

\*Corresponding author e-mail: kaankzlc@gmail.com

### **Abstract**

*Agriculture and sustainability in agriculture are issues that many countries are concerned about and emphasise with great care. Although sustainability in agriculture is primarily associated with the technical aspects of production, the protection of the manpower that carries out agricultural production is an indispensable part of sustainability today. The continuation of production by a large number of family businesses that carry out agricultural production is a guarantee that the population can access food production under favourable conditions. The maintenance of family enterprises to live in rural areas and continue agricultural production is closely related to the income they provide. Although the income of producers in the agricultural sector has been the subject of many studies, it is still in need of study and solution. In this study, it has been tried to reveal how the household income of the agricultural sector in Türkiye has changed in the 18-year period between 2006 and 2023 on the basis of 20 per cent income brackets and as average household justifiable income. Income statistics obtained from the Turkish Statistical Institute constitute the main material used in the study. In the evaluation of the compiled statistics, various evaluation methods, especially proportional calculations, real income calculations, simple index were used, the data were summarised in charts. Lorenz Curve was constructed for the distribution of agricultural entrepreneurial income and non-agricultural entrepreneurial income and a comparative evaluation was made over the curve.*

**Keywords:** Rural Area, Rural Household Income, Sustainability in Agriculture, Change in Household Income, Agricultural Income



## Statistical Innovations in Invoice Processing: From Data Extraction to Structured Analysis

Ahmet Yıldız<sup>1</sup>, Mert Güvençli<sup>2</sup>, Tuna Çakar<sup>3\*</sup>

<sup>1</sup>Apsiyon Informatics Sys. Inc., Data Science Team, Istanbul, Türkiye

<sup>2</sup>Apsiyon Informatics Sys. Inc., Software-Team Lead, Istanbul, Türkiye

<sup>3</sup>Mef University, Computer Engineering Department, 34396, Istanbul, Türkiye

\*Corresponding author e-mail: cakart@mef.edu.tr

### Abstract

*In this study, we explore the application of advanced statistical techniques and artificial intelligence to the problem of extracting and processing data from e-Archive invoices stored in PDF format. We specifically focus on the transformation of unstructured data into a structured format suitable for further statistical analysis and application, using machine learning tools such as GPT API and optical character recognition (OCR) technologies like EasyOCR. The process begins with the extraction of XML data embedded within the PDFs. These PDFs contain structured data that, while not immediately accessible due to the PDF format, hold critical information in XML tags. Using statistical parsing techniques, we systematically extract these data, ensuring accuracy and minimizing data loss. The extracted XML data is then converted to JSON format utilizing the GPT API. This stage is critical as it leverages the GPT's natural language processing capabilities to interpret and reformat XML data. Here, statistical consistency and data integrity are maintained through the use of tailored prompts that guide the conversion process, ensuring that the transformed data remains robust for statistical inference and analysis. Further, the processed data undergoes a final transformation tailored to specific use cases, such as regression analysis, clustering, and other statistical modeling approaches. This customization is directed by prompts that are statistically designed to handle various data types and distributions, thus facilitating a more nuanced data analysis. The second part of our study involves the preprocessing of photographed invoices to improve the quality of the data extraction. Techniques such as geometric correction and grayscale conversion are employed to minimize perspective distortions and enhance text visibility, which are common issues in manually captured invoice images. Statistical methods are used to evaluate the effectiveness of these image processing steps, ensuring that the data extraction phase is optimized for accuracy and efficiency. Once preprocessed, the images undergo text detection using the Craft Text Detection method, which provides a precise, character-level identification of text areas. This method's effectiveness in detecting textual data is statistically assessed to ensure high reliability and validity in subsequent OCR phases. Post text detection, EasyOCR is utilized to convert image-based text into digital format. Statistical validation of the OCR results is performed to verify the accuracy of the text recognition process, ensuring that the extracted data is suitable for further processing and analysis. This involves evaluating the OCR's performance in terms of error rates and the consistency of data extraction across different invoice formats. Finally, the OCR results are processed using the GPT API to structure the text into JSON format, which is statistically analyzed to assess data completeness and usability. Custom prompts are again employed to extract and format specific information, such as invoice numbers and totals, into a statistically sound and usable format. Through the integration of these technologies and statistical methods, our study demonstrates significant advancements in the automated processing of invoice data. This approach not only enhances the efficiency and accuracy of data processing but also facilitates the integration of invoice data into larger statistical models and analyses, potentially leading to more informed business decisions and operational improvements.*

**Keywords:** Statistical Analysis, Data Extraction, Machine Learning, Optical Character Recognition (OCR), Invoice Processing

## Hibrit İş Özellikleri Kuramı Çerçevesinde Mavi Yakalı Çalışanların İş Motivasyonu

**Tayfun Utaş<sup>1\*</sup>**

<sup>1</sup>İstinye Üniversitesi, YBS, İstanbul, Türkiye

\*Sorumlu yazar e-mail: tayfu.utas@istinye.edu.tr

### Özet

Araştırmada hibrit iş özellikleri kuramı çerçevesinde “stres” ile “bağlılık” olgusu birleştirilerek işçi, operatör, mavi yakalı ve yan sanayi çalışanlarının motivasyonunu ölçmek amacı ile Türkiye’de en iyi üretim pratiklerine sahip işletmelerde rastgele seçilmiş 479 kişi ile anket çalışması yapılmış ve “yan sanayi çalışanı olması”, “iş tanım farklılıkları” ve “çalışma yılı” ile “motivasyon” arasında önemli bir ilişki bulunmuştur. Bakım-onarım, üretim, kalite-depo çalışanlarının sırasıyla motivasyon derecelerinin azaldığı, hibrit iş özellikleri kuramı ve diğer değişkenler ile motivasyon arasında güçlü bir ilişki saptanmıştır. Çalışma sonuçlarıyla algoritma denemesi yapılmış, öz yeterlik, özerklik, geribildirim, bağlılık ve streste anket sonuçlarına göre motivasyon derecesi hesaplanarak en yüksek dereceye bakılmıştır. Farklı hesaplama yöntemlerinde motivasyon derecesi 0.78’den (en yüksek: 1.00) aşağı düşmemiştir. Stresin motivasyona azaltıcı etki yaptığını göz ardı etmemek gerektiği ortaya çıkmıştır. Sonuçlar SPSS ve LISREL ile test edildiğinde test güvenilirliği 0.90 çıkmıştır. SPSS ve LISREL sonuçlarında tüm etkilerin karşılıklı etkileşimi hesaplanıp, etki dereceleri bulunmuştur. Geribildirim ve stresin motivasyona etkisinin diğerlerinden düşük çıkmıştır. Çalışmada hibrit iş özellikleri kuramı ve ona etki eden değişkenlerin mavi yakalıların motivasyonuna etkisinin oldukça yüksek olduğu saptanmıştır. Motivasyon olgusunun “vererek” değil, “üreterek” de olabilirliği sınanmış ve rekabette üstünlük, işte verimlilik ve hayatta mutluluk için motivasyon kaynağının günlük aktiviteler olduğu görülmüştür.

**Anahtar Kelimeler:** Örgütsel bağlılık, Mavi Yaka, Motivasyon, Öz yeterlik, Stres, Yalın üretim,

**A Research Aimed at Determining the Participation Levels of Tokat People in  
Recreational Activities and Areas**

**İkbal Rabia Tuna<sup>1\*</sup>, Saliha Erdoğan<sup>1</sup>, Aysun Çelik<sup>1</sup>**

<sup>1</sup>Tokat Gaziosmanpaşa University, Faculty of Agriculture, Horticulture, 60000, Tokat, Türkiye

\*Corresponding author e-mail: ikbalrabiatusna@gmail.com

***Abstract***

*Nowadays, intensive work and business life cause the need for rest to be ignored most of the time. Meeting the need for rest makes working more efficient. In this sense, the impact of recreational activities is very important. Recreational activities have basically emerged in order to meet the need for rest. The environment in which recreational activities will take place has a proportional relationship with situations such as the level of development, welfare level, climate, time, environment, geographical location, adequacy of activity areas and social environment. In order for all the benefits of recreational activities in psychological, social, physical aspects to be revealed, it is very important to make arrangements in which users are participants. Therefore, the aim of this study, whose main subject is recreation; To determine the participation levels of Tokat people in existing recreation areas in Tokat and at the same time to create user participation plan decisions for recreation areas to be newly established or transformed. The main material of this study is the people of Tokat. The method of the study is the preparation of the survey form and data collection. The data collection part of the survey was carried out digitally. The survey consists of 2 sections and 29 multiple choice questions. 275 People participated in the study. After the survey questions were prepared, the problems encountered were solved in this direction by conducting a trial survey with 5 people. After completing the surveys, all data were recorded. By analyzing the collected data in the IBM SPSS Statistics 20 program, data were obtained on the user profile of Tokat people participating in recreational activities and the use situations of recreational areas.*

**Keywords:** Tokat, recreation, recreational activity



## Türkiye’de Hemşirelik Çalışanlarında Tükenmişlik Sendromu: Bir Meta Analiz Çalışması

**Nadire Gizem Özdemir<sup>1\*</sup>, Tayfun Utaş<sup>2</sup>**

<sup>1</sup>Hastane Sorumlu Hemşire, Koç Üniversitesi, Yoğun Bakım, İstanbul, Türkiye

<sup>2</sup>İstinye Üniversitesi, YBS, İstanbul, Türkiye

\*Sorumlu yazar e-mail: ng.ozdemir@kuh.ku.edu.tr

### Özet

Tükenmişlik, direkt insanlarla yüz yüze etkileşim halinde çalışan meslek mensuplarında yoğun bir biçimde görülen ruhsal ve duygusal bir durumdur. Sağlık personellerinin tümünde tükenmişlik yaşanabilirken bu durumdan en fazla etkilenen gruplardan biri de hemşirelerdir. Buradan hareketle bu çalışma hemşirelerin cinsiyetlerinin tükenmişlik düzeylerine etkisini belirlemek amacı ile meta analiz çalışması olarak yapılmıştır. Literatür taraması İlk olarak, “Türk Tıp Dizini, YÖK Tez merkezi, Pubmed, Google Scholar, EBSCO Host, Web of Science elektronik” veri tabanlarından makale ve tezler tarandı, ikinci olarak, ulaşılan araştırmaların referans bölümünün araştırılması yapıldı. Toplamda 8450 çalışma incelendi. Araştırma verileri; çalışmaya dâhil edilme ölçütlerine uygun olan 7’i makale ve 3’ü yüksek lisans tezi olmak üzere toplam 10 çalışmaya indirildi. Etki büyüklüğünün hesaplamasında “Hedges’ d” kullanıldı. Etki modelinin belirlenmesinde ise “Q istatistiğinden” yararlanıldı. “Q istatistiğinin sonucuna göre verilerimiz heterojen dağılım gösterdiği için rastgele etki modeli seçildi. Yayın yanlılığını test etmek amacıyla Huni grafiği (FunnelPlot) incelemesi yapıldı. Yapılan hesaplamalara göre genel etki büyüklüğü 2,891 (CMA ölçek -4/+4) olarak hemşirelerde cinsiyetin hemşirelerde tükenmişlik üzerinde etkisi olduğu tespit edildi ( $p < 0.05$ ). Bu etki büyüklüğünün Cohen’ nin sınıflamasına göre önemli düzeyde olduğu tespit edildi.

**Anahtar Kelimeler:** Hastane, Hemşire, Meta Analiz, Sağlık Sektörü Tükenmişlik, Tükenmişlik Sendromu

## Quantitative Models of Identity and Spatiotemporal Proximity: Statistical Approaches to the Ship of Theseus Paradox

Tuna Çakar<sup>1\*</sup>

<sup>1</sup>Mef University, Computer Engineering Department, 34396, Istanbul, Türkiye

\*Corresponding author e-mail: cakart@mef.edu.tr

### Abstract

*This study delves into the cognitive mechanisms underlying identity judgments through the application of the Conceptual Tendency Test (CTT) within a spatiotemporal framework, using the Ship of Theseus as a model. Our research framework integrates rigorous statistical methodologies to dissect how variations in spatiotemporal proximity influence individual decisions about object identity over time, especially when confronted with gradual but comprehensive changes. Employing a mixed-method approach, we first administered the CTT to a diverse cohort, capturing baseline tendencies in perceiving identity continuity against physical transformation. Responses were quantitatively analyzed using logistic regression models to predict the influence of spatiotemporal factors on identity judgments. This analysis was complemented by factorial designs that isolated the effects of perceptual continuity from those of mereological (part-whole) transformations. The findings reveal that spatiotemporal proximity significantly shapes cognitive assessments of object persistence, highlighting a strong interaction with conceptual biases pre-assessed through the CTT. Participants exhibited varying degrees of acceptance towards object identity based on the continuity of spatial and temporal presence, which correlates with their responses to the conceptual challenges posed by the CTT. Moreover, the statistical interaction effects elucidated how different modalities (visual vs. textual) presented in the test scenarios affected the outcomes. The modeling results used SPSS (version 21) to employ Discriminant Analysis (DA), Decision Tree (DT), and Neural Network (NN) methods. Discriminant analysis classified responses to the Ship of Theseus based on linear combinations of variables from the CTT, with 88.6% accuracy in classifying strong and weak judgments for each ship. Decision tree analysis revealed a predictive success of 84.1%, highlighting the critical role of specific propositions in identity judgments. Lastly, neural network modeling achieved a 92.3% predictive success rate, further demonstrating the robustness of our models in capturing cognitive responses to identity challenges. The obtained findings reveal that spatiotemporal proximity significantly shapes cognitive assessments of object persistence, highlighting a strong interaction with conceptual biases pre-assessed through the CTT. Participants exhibited varying degrees of acceptance towards object identity based on the continuity of spatial and temporal presence, which correlates with their responses to the conceptual challenges posed by the CTT. The implications of this study extend beyond theoretical explorations of identity, offering practical insights into how humans integrate temporal and spatial information to form judgments about continuity. This work contributes to the broader discourse on cognitive science by highlighting the complex interplay between grounded cognition theories and empirical data derived from innovative conceptual testing.*

**Keywords:** Discriminant Analysis, Decision Tree Analysis, Neural Network Modeling, Spatiotemporal Proximity, Identity Judgments

**Using Two – Step Cluster Analysis to Classify Customers Who Have an Omnichannel Experience in Customer Journey**

**Nedret Erboy**<sup>1\*</sup>

<sup>1</sup>Muğla Sıtkı Koçman University, Muğla Vocational School, Department Of Accounting and Taxation, 48000, Muğla, Türkiye

\*Corresponding author e-mail: nedreterboy@mu.edu.tr

***Abstract***

*With multiple online and offline channels being used together in the customer journey and becoming more integrated with each other, customer behavior is becoming more complex and in parallel with channel strategies become difficult to determine. In order to see these changes more clearly and to develop more accurate strategies, it has become more important to segment customers and determine the characteristics of each segment. In this context, in this study, the factors affecting the omnichannel banking experience in the customer journey on the basis of three different channels used in banking transactions (internet, mobile and offline (branch+ATM)) are discussed and university students are segmented according to their motivations for using all three channels and the channels they use at different stages of the customer journey. Two-stage clustering analysis was applied to the data obtained through face-to-face and online channels to identify customer segments using SPSS Clemente, the data mining module of SPSS.*

**Keywords:** *Omnichannel Customer Experience, Two-Step Clustering, Customer Journey, Banking Sector*



## Makine Öğrenmesi Yöntemleri ile Boyut Azaltmanın Model Performans Ölçütleri Üzerindeki Etkileri

Filiz Kanbay<sup>1</sup>, Pinar Dasdemi<sup>1\*</sup>

<sup>1</sup>Yıldız Teknik Üniversitesi, Fen-Edebiyat Fakültesi, Matematik Bölümü, 34220, İstanbul, Türkiye

\*Sorumlu yazar e-mail: pinardasdemi1@gmail.com

### Özet

Günümüzde finans, bankacılık, veri madenciliği gibi birçok alanda sınıflandırma, kümeleme ve tahmin için kullanılan makine öğrenimi sağlık alanında da kullanılmaktadır [1]. Literatürde makine öğrenimi ile hastalıkların erken tanısını sağlayan birçok çalışma bulunmaktadır [2], [3]. Bu çalışmada, UCI Machine Learning Repository internet sitesinden İslam ve ark. tarafından hazırlanan diyabetle ilgili 520 kişiye ait 15 kategorik (Gender, Polyuria, Polydipsia, Sudden weight loss, Weakness, Polyphagia, Genital thrush, Visual blurring, Itching, Irritability, Delayed healing, Partial paresis, Muscle stiffness, Alopecia, Obesity) 1 nümerik (Age) toplam 16 öznitelik içeren “Early Stage Diabetes Risk Prediction” veri seti kullanılarak bu veri setine K-En yakın komşu, Naive bayes, Destek vektör makineleri, Rastgele orman, Karar ağaçları ve Boosting makine öğrenmesi algoritmaları uygulanmıştır [4, 5]. Modelleme, Anaconda Navigator ortamında Python dili kullanılarak geliştirilmiştir. Belirlenen matematiksel modellerin model başarısını maksimize eden hiperparametreler belirlenmiş ve model başarı kriterleri belirlenmiştir. Sonrasında temel bileşen analizi kullanılarak veri boyutu azaltılmış ve bu işlemin model performans ölçütleri üzerindeki etkileri incelenmiştir.

**Anahtar Kelimeler:** K-en Yakın Komşu Algoritması, Rastgele Orman Algoritması, Destek Vektör Makineleri, Naive Bayes Algoritması, Temel Bileşen Analizi.

Bu çalışma Yıldız Teknik Üniversitesi Bilimsel Araştırma Projeleri Koordinasyon Birimince Desteklenmiştir. Proje Numarası: FYL-2024-6295.

**Using Multi-Criteria Decision-Making Techniques Determining the Proximity of  
Factories in Ankara to Industry 4.0 Technologies**

**Esra Aktas<sup>1\*</sup>, Akın Bahattin Şen<sup>2</sup>, Ediz Atmaca<sup>3</sup>**

<sup>1</sup>Gümüşhane University, Department of Occupational Health and Safety, 29100, Gümüşhane, Türkiye

<sup>2</sup>Karabük University, Department of Industrial Engineering, 78050, Karabük, Türkiye

<sup>3</sup>Gazi University, Department of Industrial Engineering, 06570, Ankara, Türkiye

\*Corresponding author e-mail: esra.aktas@gumushane.edu.tr

***Abstract***

*The need for a new industrial revolution has grown due to the need for an industrial structure that can work more flexibly, produce more efficiently, and meet higher expectations, in order to replace old production systems that cannot meet consumers' demands for higher quality and personalised products. The fourth industrial revolution, which arose in response to these needs, includes numerous modern automation systems, data exchanges, and manufacturing technologies. Industry 4.0 is a set of values that includes the internet of everything, internet services, and cyberphysical systems. This study was conducted to assess the readiness of Turkey's existing industrial technology infrastructure for the transition to the new industrial revolution. In this regard, a survey was conducted on a sample of factories in Ankara to determine the companies' proximity to the fourth industrial revolution. The survey results were analyzed using multi-criteria decision-making techniques. Based on the findings, a report was created that could serve as an example for Turkey in terms of Industry 4.0 compliance.*

**Keywords:** Industry 4.0, MCDM, AHP, TOPSIS

Konut Fiyatları Endeksi Yöntemleri ve Uygulama & Çalışması

Cem Bas<sup>1\*</sup>

<sup>1</sup>Türkiye İstatistik Kurumu, Fiyat İstatistikleri Daire Başkanlığı, 06100, Ankara, Türkiye

\*Sorumlu yazar e-mail: cembas@tuik.gov.tr

**Özet**

*Konut Fiyat Endeksi, ekonomiye yön veren göstergelerden bir tanesidir ve konut piyasasını yansıtan öncül göstergelerin ilk adımıdır. Konut fiyatları çok heterojen bir yapıya sahiptir ve tüketiciler farklı kalite ve yapıdaki bu konutları içeren bir havuzdan tüm konut bileşenlerini içeren bir ürünü satın almaktadır. Hedonik fiyat endeksinin ana mantığı, heterojen özellik taşıyan malların sahip oldukları özelliklere göre fiyatlandırılarak fiyat ve heterojen özellikler arasında ilişkinin kurulmasıdır. Hedonik konut fiyat endeksi bu bağlamda, her bir konutun karakteristik özellikleri için fiyatları gösterirken her bir karakteristik için değerlerin bütünü hakkında bilgi verir. Hedonik fiyat endeksi, regresyon analizi kullanılarak bir malın ya da konutun fiyatına etki eden karakter özelliklerinin değerlerinin ayrıştırılmasında kullanılan bir yöntemdir. Bu yöntem, konut piyasasının analizinin yapılması içinde sıklıkla başvurulan bir yöntemdir. Konut piyasasında farklı türdeki konutların fiyatlarının tahmin edilmesinde, metrekare, oda sayısı, konum gibi özelliklerin konut fiyatları üzerindeki etkilerinin belirlenmesinde hedonik yöntem kullanılmaktadır. Satışa konu olan konutların satış değerleri belirlenirken, konutun fiziksel, yapısal, konumsal özellikleri, çevresiyle uyum içinde olup olmaması, konutla ilgili arz talep dengesi, arzu edilen bir konut olması, yatırım aracı olarak görülebilmesi, ihtiyaca göre sosyal imkanlara sahip olması gibi önemli özellikler dikkate alınmaktadır. Bu çerçevede emlakçılara ve konut satışını gerçekleştiren hane halklarına uygulanan soru kağıdında konutların bu tür özelliklerini ön plana çıkaran sorular sorulmuştur. Bu çalışmada 2009 ve 2010 yılı ilk altı aylık dönem için Ankara merkez ilçelerinde satışa konu olan konutlar için konut fiyat endeksleri üretilip değişim oranları hesaplanmıştır.*

**Anahtar Kelimeler:** Hedonik Fiyat Endeksi, Konut Fiyatlarının Belirleyicileri, Regresyon Analizi



**Türkiye’de Zeytin Fiyatı ile Zeytin Üretim Alanı ve Üretim Miktarı Arasındaki İlişkinin  
Toda-Yamamoto Testi ile Belirlenmesi**

**Kaan KAPLAN<sup>1\*</sup>, Halil KIZILASLAN<sup>1</sup>**

<sup>1</sup> Tokat Gaziosmanpaşa Üniversitesi, Ziraat Fakültesi, Tarım Ekonomisi Bölümü, 60200, Tokat,  
Türkiye

\*Sorumlu yazar e-mail: kaan.kaplan@gop.edu.tr

**Özet**

*Dünyada yaklaşık 30 farklı ülkede yetiştirilen zeytin, ülkelerin dış ticaretleri açısından önem arz etmektedir. Bu ticaretin etkileri Akdeniz havzasındaki ülkelerin zeytin üretimini tetiklemektedir. Bu sebeple uluslararası zeytin fiyatları ticarete önemli rol oynamaktadır. Türkiye, zeytin üretimine uygun iklim koşulları nedeniyle gerek sofralık zeytin gerekse zeytinyağı üretimi açısından dünyanın önde gelen ülkelerinden biridir. Bu çalışmada Türkiye zeytin ürün fiyatı, zeytin üretim alanı ve zeytin üretim miktarı arasındaki nedensellik ilişkisi belirlenmeye çalışılmıştır. Çalışmada öncelikle birim kök testlerine bakılmış ve serilerin hem düzeyde hem birinci farkta durağan olduğu tespit edilmiştir. Farklı seviyelerde durağanlığın olması sebebiyle uygun yöntem olarak Toda-Yamamoto nedensellik testi belirlenmiştir. Uygun VAR modeli ve gecikme uzunluğu belirlenerek gerekli sınamalar yapılmıştır. Buna göre ürün fiyatı ile üretim alanı arasındaki wald test 10.29723, olasılık değeri 0.0162 olarak tespit edilmiş, üretim fiyatı ile ekili alan arasındaki wald test 10.69738 ve olasılık değeri 0.0135 olarak bulunmuştur.*

**Anahtar Kelimeler:** Zeytin, Türkiye, Toda-Yamamoto, Nedensellik



# **FULL TEXT ORAL PRESENTATIONS**

## Medical Decision Making Using Fuzzy Soft Set Method

Zeynep Keskin<sup>1\*</sup> Rahmet Savaş<sup>2</sup>

<sup>1</sup>Istanbul Medeniyet University, Faculty of Engineering and Natural Sciences, Department of Mathematics, 34000, Istanbul, Türkiye

<sup>2</sup>Haliç University, Faculty of Science and Literature, Department of Mathematics, 34000, Istanbul, Türkiye

\*Corresponding Author e-mail: rahmetsavas@halic.edu.tr

### Abstract

In this study, an optimal final decision will be made regarding the patient or patients with the highest risk of having the disease by optimizing the opinions of two different specialist doctors using the Fuzzy Soft Set (FSS) method, based on the attribute values determined for patients suspected of having thyroid cancer. This method aims to save time and energy for both doctors and patients. In the diagnosis of thyroid cancer, blood and ultrasonography values are taken as parameters in the Fuzzy Soft Set (FSS) method, and the Roy-Maji approach is applied in decision making. As a result, an optimal final decision is made about the patient or patients with the highest risk of developing thyroid cancer.

**Keywords:** Fuzzy Soft Set, Optimal Decision Making, Fuzzy Set, Thyroid Cancer

### Introduction

Economics, engineering, social sciences, and medical sciences encompass many complex uncertainties. All these problems encountered cannot be solved with classical mathematical methods. In classical mathematics, a mathematical model of an object is designed, and a model is determined as a concept of a precise solution. However, this mathematical model is too complex for problems involving uncertainty, and a precise solution cannot be found. Therefore, many theories have been developed to solve these problems. One of these is the Theory of Fuzzy Sets.

The concept of fuzzy sets was developed by Lotfi Zadeh. In 1965, he discussed the fundamentals of fuzzy logic in his paper "The Theory of Fuzzy Logic and Fuzzy Sets" published at the University of California, Berkeley (Zadeh L.A, 1965). For situations where the concept of fuzzy sets is inadequate, Molodstov developed the concept of Soft Set in 1999 (Molodtsov, 1999). The Soft Set theory has been accepted as an effective mathematical tool for dealing with uncertainties. While Ali and colleagues provided some concepts related to Soft Sets (Ali et al., 2009), A. Sezgin and A.O. Atagün defined operations such as intersection, extended intersection, restricted union, and restricted difference on Soft Sets (Sezgin and Atagün, 2011).

In 2001, Maji and colleagues examined the soft set theory initiated by Molodstov and developed several fundamental concepts of the soft set theory (Maji et al., 2001). In 2009, Ahmad and Kharal advanced Maji's conclusions (Ahmad and Kharal, 2009). In 2010, Çağman and colleagues defined the soft matrix, which represents a soft set, to make operations more functional in theoretical studies on soft sets (Çağman, N., Enginoğlu, 2010). In 2011, Yong and colleagues successfully applied the proposed concept of fuzzy soft matrices to some decision-making problems (Yang, Y., Ji C. 2011). In 2011, Neog and Sut defined the addition operation for fuzzy soft matrices and used this concept to solve a decision problem (Borah M.J., Neog. T.J., Sut D.K., 2012). In 2020, Kirişçi used the fuzzy soft set method for medical decision making in cardiovascular system disease (Kirişçi M., 2020).



In this study, after all the definitions related to Fuzzy Set, Soft Set, and Fuzzy Soft Set are given, the operations of these sets will be defined, and an application related to medical decision making will be included using the Fuzzy Soft Set method on a real dataset.

**PRELIMINARIES**

**Definition 1:** Let  $X$  be a non-empty set and  $A$  be a subset of  $X$  ( $A \subseteq X$ ). The characteristic function  $X_A$  of  $A$  is defined as follows:

$$X_A: X \rightarrow [0, 1],$$

$$\forall x \in X, \quad X_A(x) = \begin{cases} 1, & \text{if } x \in A \\ 0, & \text{if } x \notin A \end{cases}$$

**Definition 2:** Let  $X$  be a non-empty set and  $A$  be a subset of  $X$  ( $A \subseteq X$ ). The function  $F_A$ , called the characteristic function of  $A$ , is defined as follows:

$F_A(x): X \rightarrow [0, 1]$  is a fuzzy set on  $X$  and is represented as:

$$A = \{(x_i, F_A(x_i)): F_A(x_i) \in [0, 1]; \forall x_i \in X\}$$

A fuzzy set  $A$  on  $X$  is expressed as a set of ordered pairs as follows:

$$A = \{(x, F_A(x)) : x \in X\}.$$

**Definition 3:** Let  $P(U)$  be the power set of  $U$ . Let  $E$  be a parameter set. Given a mapping  $F: E \rightarrow P(U)$ , the pair  $(F, E)$  is called a soft set on  $U$ .

**Definition 4:** Let  $A \subset E$  and  $B \subset E$ . Suppose  $(F, A)$  and  $(G, B)$  are two soft sets on  $U$ . The pair  $(F, A)$  is called a soft subset of  $(G, B)$  if the following conditions are satisfied:

- i.  $A \subset B$ ,
- ii.  $F(\alpha)$  and  $G(\alpha)$  are identical approximations, for all  $\alpha \in A$ .

This is denoted as  $(F, A) \tilde{\subset} (G, B)$ .

**Definition 5:** Let  $P(U)$  denotes the set of all fuzzy sets of  $U$  and  $R_i \subset E$ . Give  $F_i: R_i \rightarrow P(U)$  be a mapping. Then  $(F_i, R_i)$  is called fuzzy soft set over  $U$ .

**Definition 6:** Let  $(F, A)$  and  $(G, B)$  be two fuzzy soft sets on  $U$ . If the following conditions are hold, than it is said that  $(F, A)$  is a fuzzy soft subset of  $(G, B)$ .

- i.  $A \subset B$ ,
- ii.  $F(\alpha)$  is a fuzzy soft set of  $G(\alpha)$ , for all  $\alpha \in A$ .

We write  $(F, A) \tilde{\subset} (G, B)$ .

**Definition 7:** Let  $(F, A)$  and  $(G, B)$  be two fuzzy soft sets  $U$ .  $H(\alpha, \beta) = F(\alpha) \tilde{\cap} G(\beta)$ ;  $((\alpha, \beta) \in AXB)$  it is the intersection operation of two fuzzy soft sets. Then  $F(\alpha) \wedge G(\beta) = (H, AXB)$  is called  $(F, A)$  "AND"  $(G, B)$ .

**Definition 8:** Let  $(F, A)$  and  $(G, B)$  be two fuzzy soft sets  $U$ . Define  $K(\alpha, \beta) = F(\alpha) \tilde{\cup} G(\beta)$ ;  $((\alpha, \beta) \in AXB)$ . Then  $F(\alpha) \vee G(\beta) = (K, AXB)$  is called  $(F, A)$  "OR"  $(G, B)$ .

**Method**

*FSS Method*

The Fuzzy Soft Set (FSS) method, a medical decision-making technique, will be used in this study for diagnosing patients suspected of having thyroid cancer. In this method, the age and ultrasonography (USG) results obtained from the patients will be taken as parameters, and the patients' pathology results will be used to determine the method's effectiveness. The Roy-Maji algorithm will be applied to the parameters obtained. This algorithm involves creating a Comparison Table using FSS and making a final optimal decision regarding the diagnosis of patients based on the maximum score obtained from this table.

While creating the Comparison Table, there will be objects  $p_1, p_2, \dots, p_n$  in the rows and columns. As a result, this table is a square table consisting of equal rows and columns. The entries in the Comparison Table are denoted as  $c_{ij}$ , ( $i, j=1, 2, \dots, n$ ). These entries are defined as the number of parameters for which the membership value of  $p_i$  exceeds or is equal to the membership value of  $p_j$ .

If we take the number of parameters in FSS as  $k$ , it is clear that for all  $i, j$ ,  $0 \leq c_{ij} \leq k$ . Additionally, since  $c_{ij}=k$  it is understood that  $c_{ij}$  is an integer as a numerical measure.

The formula  $r_i = \sum_{j=1}^n c_{ij}$  calculates the row total for a parameter  $p_i$ . Similarly, the formula  $t_j = \sum_{i=1}^n c_{ij}$  gives the column total for a parameter  $p_j$ . The formula  $S_i = r_i - t_j$  provides the score for  $p_i$ .

**Data Set**

In this application using the Fuzzy Soft Set (FSS) method, patient data obtained from the Endocrinology department of Ümraniye Training and Research Hospital were used. The dataset contains 33 patient records and 8 attributes that help in the diagnosis of thyroid cancer.

The results obtained from the dataset are given as a disease degree. This rating is an integer between 0 (no presence) and 4. This rating was carried out by two different specialist doctors who examined the patient data.

The attributes obtained from the dataset and their corresponding parameters are shown in Table 1.

<i>Parameters</i>	<i>Attributes</i>
$\alpha_1$	age (in years)
$\alpha_2$	echogenicity
$\alpha_3$	composition
$\alpha_4$	margins
$\alpha_5$	ttw
$\alpha_6$	calcification
$\alpha_7$	vascularity

Table 1

In the FSS method, the membership functions according to the attribute values are considered as follows.

$\alpha_1$ : age

0-20	0,0-0,2
21-40	0,3-0,5
41-60	0,6-0,8
61+	0,9-1,0

$\alpha_2$ : echogenicity

anechoic	0,1
hyperechoic	0,3
isoechoic	0,5

hypoechoic	0,9
------------	-----

$\alpha_3$ : composition

purely cystic	0,1
spongiform partially cystic	0,3
partially cystic with a solid component	0,5
Solid	0,9

$\alpha_4$ : margins

well-defined margins	0,1
irregular margin or lobulated	0,5
Extra thyroidal extension	0,9

absent	0,0
present	0,9

$\alpha_5$ : ttw

absent	0,0
present	0,9

$\alpha_7$ : vascularity

absent	0,0
comet tail	0,1
peripheral	0,2
macrocalcification	0,5
micro and macrocalcification	0,7
microcalcification	0,9

$\alpha_6$ : calcification

*Algorithm:*

The algorithm developed by Roy and Maji is as follows:

- i. Input the FSSs  $(F, A)$ ,  $(G, B)$  and  $(H, C)$ ,
- ii. Input the parameter set  $P$  obtained as a result of observations,,
- iii. Compute the corresponding resultant FSSs  $(K, D)$  from the FSSs  $(F, A)$ ,  $(G, B)$   $(H, C)$  and place it in the tabular form,
- iv. Construct the Comparison-table of FSS  $(K, D)$  and the compute  $r_i$  and  $t_i$  for  $\alpha_i$ , for all  $i$ ,
- v. Compute the score of  $\alpha_i$  for all  $i$ ,
- vi. The decision is  $S_k$  if  $S_k = \max_i S_i$
- vii. If  $k$  has more than one value then any one of  $ak$  may be chosen. Algorithm

### Application

In the diagnosis process of patients suspected of having thyroid cancer, the biopsy procedure required for diagnosis takes a long time, such as one month, in state hospitals due to patient density. The large number of patients negatively affects the timing of the diagnosis and treatment process. Additionally, different specialist doctors' opinions highlight the necessity of making an optimal decision in determining the risk status of patients and the decision-making phase.

In this section, an application of the Fuzzy Soft Set (FSS) method for medical decision-making related to thyroid cancer using the Roy-Maji algorithm will be presented.

For this application, the dataset obtained from Ümraniye Training and Research Hospital will be used. This dataset contains records of 33 patients. For the application, the set of patients is chosen as  $U = \{p_1, p_2, p_3, p_4, p_5, p_6, p_7, p_8, p_9, p_{10}\}$ . The attribute values obtained from the dataset for the selected patients are indicated in Table 2.



**V. INTERNATIONAL APPLIED STATISTICS CONGRESS (UYİK - 2024)**  
**İstanbul / Türkiye, May 21-23, 2024**

**Patient Attribute Table**

	$\alpha_1$	$\alpha_2$	$\alpha_3$	$\alpha_4$	$\alpha_5$	$\alpha_6$	$\alpha_7$	Patoloji
p <sub>1</sub>	63	isoechoic	partially cystic with a solid component	well-defined margins	absent	absent	vascularity absent	cancer
p <sub>2</sub>	40	isoechoic	partially cystic with a solid component	well-defined margins	present	absent	vascularity absent	cancer
p <sub>3</sub>	53	isoechoic	partially cystic with a solid component	well-defined margins	absent	absent	vascularity absent	cancer
p <sub>4</sub>	22	isoechoic	partially cystic with a solid component	well-defined margins	absent	absent	vascularity absent	cancer
p <sub>5</sub>	29	isoechoic	partially cystic with a solid component	well-defined margins	absent	absent	vascularity absent	cancer
p <sub>6</sub>	26	hypoechoic	partially cystic with a solid component	well-defined margins	present	makrokalsifikasyon	vascularity absent	not cancer
p <sub>7</sub>	65	hypoechoic	solid	well-defined margins	absent	makrokalsifikasyon	peripheral vascularity	not cancer
p <sub>8</sub>	49	isoechoic	partially cystic with a solid component	well-defined margins	absent	mikrokalsifikasyon	vascularity absent	not cancer
p <sub>9</sub>	55	hypoechoic	solid	well-defined margins	absent	mikro ve makrokalsifikasyon	vascularity absent	not cancer
p <sub>10</sub>	70	hypoechoic	solid	well-defined margins	absent	mikrokalsifikasyon	vascularity absent	not cancer

Table 2

In this application, three FSS have been created. FSS ( $F, A$ ) is defined by patients and attributes. FSS ( $G, B$ ) is created based on measurements obtained from the dataset of Dr. X (1<sup>st</sup> specialist doctor), expressing the disease degrees of selected patients as 0, 1, 2, 3, 4. FSS ( $H, C$ ) is created based on measurements obtained from the dataset of Dr. Y (2<sup>nd</sup> specialist doctor), expressing the disease degrees of selected patients as 0, 1, 2, 3, 4.

**FSS ( $F, A$ )**

	$\alpha_1$	$\alpha_2$	$\alpha_3$	$\alpha_4$	$\alpha_5$	$\alpha_6$	$\alpha_7$
p <sub>1</sub>	0,9	0,5	0,5	0,1	0,0	0,0	0,0
p <sub>2</sub>	0,5	0,5	0,5	0,1	0,9	0,0	0,0
p <sub>3</sub>	0,5	0,5	0,5	0,1	0,0	0,0	0,0
p <sub>4</sub>	0,3	0,5	0,5	0,1	0,0	0,0	0,0
p <sub>5</sub>	0,3	0,5	0,5	0,1	0,0	0,0	0,0
p <sub>6</sub>	0,3	0,9	0,5	0,1	0,9	0,5	0,0
p <sub>7</sub>	0,9	0,9	0,9	0,1	0,0	0,5	0,1
p <sub>8</sub>	0,6	0,5	0,5	0,1	0,0	0,9	0,0
p <sub>9</sub>	0,7	0,9	0,9	0,1	0,0	0,7	0,0
p <sub>10</sub>	0,9	0,9	0,9	0,1	0,0	0,9	0,0

Table-3

*FSS (G,B)*

	1	2	3	4	0
p <sub>1</sub>	0,6	0,3	0,2	0,0	0,7
p <sub>2</sub>	0,6	0,8	0,9	0,5	0,0
p <sub>3</sub>	0,5	0,3	0,2	0,1	0,2
p <sub>4</sub>	0,7	0,4	0,2	0,0	0,5
p <sub>5</sub>	0,6	0,3	0,1	0,0	0,8
p <sub>6</sub>	0,2	0,5	0,6	0,9	0,0
p <sub>7</sub>	0,3	0,5	0,8	0,9	0,0
p <sub>8</sub>	0,8	0,9	0,8	0,5	0,0
p <sub>9</sub>	0,7	0,8	0,9	0,8	0,0
p <sub>10</sub>	0,2	0,5	0,7	0,9	0,0

Table 4

*FSS (H,C)*

	1	2	3	4	0
p <sub>1</sub>	0,6	0,3	0,2	0,0	0,8
p <sub>2</sub>	0,5	0,7	0,8	0,4	0,2
p <sub>3</sub>	0,5	0,4	0,3	0,1	0,5
p <sub>4</sub>	0,7	0,5	0,3	0,1	0,4
p <sub>5</sub>	0,6	0,3	0,1	0,0	0,8
p <sub>6</sub>	0,3	0,6	0,7	0,5	0,1
p <sub>7</sub>	0,2	0,4	0,6	0,7	0,1
p <sub>8</sub>	0,7	0,8	0,7	0,5	0,2
p <sub>9</sub>	0,6	0,7	0,8	0,6	0,1
p <sub>10</sub>	0,4	0,5	0,6	0,8	0,2

Table-5

After all FSSs are expressed, FSSs  $(F, A)$  and  $(G, B)$  from Tables 3 and 4 are taken sequentially, and the operation " $(F, A)$  AND  $(G, B)$ " is performed with  $e_{ij} = \alpha_i \wedge b_j$ . The  $e_{i,j}$  parameters are taken as follows:

$$D = \{e_{11}, e_{22}, e_{32}, e_{45}, e_{54}, e_{61}, e_{75}\}$$

Then, the resulting FSS for  $(F, A)$  and  $(G, B)$  will be  $(K, D)$ . The  $e_{i,j}$  values for all patients in set  $D$  have been calculated, and Table 8 has been created. Sample calculations are as follows:

For patient  $P_1$ :

$$e_{11} = \alpha_1 \wedge b_1 = 0,9 \wedge 0,6 = 0,6$$

$$e_{54} = \alpha_5 \wedge b_4 = 0,0 \wedge 0,0 = 0,0$$

$$e_{22} = \alpha_2 \wedge b_2 = 0,5 \wedge 0,3 = 0,3$$

$$e_{61} = \alpha_6 \wedge b_1 = 0,0 \wedge 0,6 = 0,0$$

$$e_{32} = \alpha_3 \wedge b_2 = 0,5 \wedge 0,3 = 0,3$$

$$e_{75} = \alpha_7 \wedge b_5 = 0,0 \wedge 0,7 = 0,0$$

$$e_{45} = \alpha_4 \wedge b_5 = 0,1 \wedge 0,7 = 0,1$$

*FSS (K,D)*

	$e_{11}$	$e_{22}$	$e_{32}$	$e_{45}$	$e_{54}$	$e_{61}$	$e_{75}$
$p_1$	0,6	0,3	0,3	0,1	0,0	0,0	0,0
$p_2$	0,5	0,5	0,5	0,0	0,5	0,0	0,0
$p_3$	0,5	0,3	0,3	0,1	0,0	0,0	0,0
$p_4$	0,3	0,4	0,4	0,1	0,0	0,0	0,0
$p_5$	0,3	0,3	0,3	0,1	0,0	0,0	0,0
$p_6$	0,2	0,5	0,5	0,0	0,9	0,2	0,0
$p_7$	0,3	0,5	0,5	0,0	0,0	0,3	0,3
$p_8$	0,6	0,5	0,5	0,0	0,0	0,8	0,0
$p_9$	0,7	0,8	0,8	0,0	0,0	0,7	0,0
$p_{10}$	0,2	0,5	0,5	0,0	0,0	0,2	0,0

Table 6

“*FSS (K,D)* VE *FSS (H,C)*” operation is performed in the specified set E, resulting in the creation of *FSS (M, E)* as shown in Table 7. Some calculations for *FSS (M, E)* are as follows:

$$E = \{ e_{11} \wedge c_3, e_{22} \wedge c_2, e_{32} \wedge c_2, e_{45} \wedge c_5, e_{54} \wedge c_4, e_{61} \wedge c_1, e_{75} \wedge c_5 \}$$

For patient  $P_i$ :

$$e_{11} \wedge c_3 = 0,6 \wedge 0,2 = 0,2$$

$$e_{22} \wedge c_2 = 0,3 \wedge 0,3 = 0,3$$

$$e_{32} \wedge c_2 = 0,3 \wedge 0,3 = 0,3$$

$$e_{45} \wedge c_5 = 0,1 \wedge 0,8 = 0,1$$

$$e_{54} \wedge c_4 = 0,1 \wedge 0,0 = 0,0$$

$$e_{61} \wedge c_1 = 0,6 \wedge 0,0 = 0,0$$

$$e_{75} \wedge c_5 = 0,0 \wedge 0,8 = 0,0$$

*FSS (M, E)*

	$e_{11} \wedge c_3$	$e_{22} \wedge c_2$	$e_{32} \wedge c_2$	$e_{45} \wedge c_5$	$e_{54} \wedge c_4$	$e_{61} \wedge c_1$	$e_{75} \wedge c_5$
$p_1$	0,2	0,3	0,3	0,1	0,0	0,0	0,0
$p_2$	0,5	0,5	0,5	0,0	0,4	0,0	0,0
$p_3$	0,3	0,3	0,3	0,1	0,0	0,0	0,0
$p_4$	0,3	0,4	0,4	0,1	0,0	0,0	0,0
$p_5$	0,1	0,3	0,3	0,1	0,0	0,0	0,0
$p_6$	0,2	0,5	0,5	0,0	0,5	0,2	0,0
$p_7$	0,3	0,4	0,4	0,0	0,0	0,2	0,1
$p_8$	0,6	0,5	0,5	0,0	0,0	0,7	0,0
$p_9$	0,7	0,7	0,7	0,0	0,0	0,6	0,0
$p_{10}$	0,2	0,5	0,5	0,0	0,0	0,2	0,0

Table 7

After performing operator operations with fuzzy soft sets, the newly formed fuzzy soft set *FSS (M, E)* will be used to create a Comparison Table based on its values.

In the Comparison Table, the rows and columns contain the names of selected patients (objects). Entries in the Comparison Table are denoted as  $k_{ij}$  where  $(i,j=1,2,3,\dots,n)$ . These entries will be created based on the membership values in the generated *FSS (M, E)* table.



**V. INTERNATIONAL APPLIED STATISTICS CONGRESS (UYIK - 2024)**  
**İstanbul / Türkiye, May 21-23, 2024**

Let  $m_{ij}$  represent the entries in the  $FSS (M, E)$  table. Entries in the Comparison Table are defined as the number of parameters where the membership value of  $m_i$  in  $FSS (M, E)$  is greater than or equal to the membership value of  $m_j$ .

Since our  $FSS (M, E)$  has 7 parameters in our application, for all  $i, j$ , it holds that  $0 \leq k_{ij} \leq 7$ . Additionally,  $k_{ii} = 7$  is also clear. For example, the calculation for entry  $k_{3,1}$  in the Comparison Table is as follows: For entry  $k_{3,1}$ , we will look at the membership values of patient  $p_3$  in the row and patient  $p_1$  in the column in the  $FSS (M, E)$  table. We count how many parameters where the membership value of patient  $p_3$  is greater than or equal to the membership value of patient  $p_1$ .

$p_3$	0,3	0,3	0,3	0,1	0,0	0,0	0,0
$p_1$	0,2	0,3	0,3	0,1	0,0	0,0	0,0

When we look at the membership values above, the number of parameters where the membership value of patient  $p_3$  exceeds or is equal to the membership value of patient  $p_1$  is '7'. When these calculations are done for all  $k_{ij}$  values, the Comparison Table will be as shown in Table 8.

**Comparison Table**

	$p_1$	$p_2$	$p_3$	$p_4$	$p_5$	$p_6$	$p_7$	$p_8$	$p_9$	$p_{10}$
$p_1$	7	3	6	4	7	3	2	3	3	4
$p_2$	6	7	6	6	6	5	5	5	3	6
$p_3$	7	3	7	5	7	3	3	3	3	4
$p_4$	7	3	7	7	7	3	5	3	3	4
$p_5$	6	3	6	4	7	2	2	3	3	3
$p_6$	6	6	5	5	6	7	5	5	3	7
$p_7$	6	3	6	6	6	4	7	3	3	5
$p_8$	6	6	6	6	6	6	6	7	4	7
$p_9$	6	6	6	6	6	6	6	6	7	7
$p_{10}$	6	5	5	5	6	6	5	5	3	7

Table 8

Using the Comparison Table, the row totals  $r_i$ , the column totals  $t_i$ , and the differences  $s_i$  have been calculated, and Table 9 has been created.

**$r_i, t_i, s_i$**

	$r_i$	$t_i$	$s_i$
$p_1$	42	63	-21
$p_2$	55	45	10
$p_3$	45	60	-15
$p_4$	49	54	-5
$p_5$	39	64	-25
$p_6$	55	45	10
$p_7$	49	46	3
$p_8$	60	43	17
$p_9$	62	35	<b>27</b>
$p_{10}$	53	54	-1

Table 9

From Table 9, it can be seen that patient  $p_9$  has the maximum score of 27 points. Therefore, the medical decision is made for patient  $p_9$ .

## EVALUATION

According to the results obtained, Patient 9 is identified as the highest-risk patient for Thyroid Cancer. This conclusion aligns with doctor feedback. However, upon reviewing the pathology results, it is evident that Patient 9 is not at high risk. This indicates that while the method correctly operates based on the attributes we considered, the most definitive diagnosis for Thyroid Cancer can only be made with pathology results.

As a result, the Roy-Maji method is not suitable for diagnosing Thyroid Cancer. However, it is a suitable optimization/decision-making method for situations where decisions can be made based on specific variables.

Determining a mathematical medical decision-making method for diagnosing Thyroid Cancer is an open problem for future studies.

## References

- Ahmad, B., Kharal, A. 2009. On fuzzy soft sets, *Advances in Fuzzy Systems*, pp. 1–6.
- Ali M.I. , Feng F. , Liu X. , Min W. K. 2009. Shabir M. , On some new operations in soft set Theory. *Comput. Math. Appl.*, 57(9.9: 1547-1553)
- Biswas, R.,Maji, P.K., Roy A.R., 2001. *Journal of Fuzzy Mathematics*, 9, pp. 589–602
- Borah M.J.,Neog. T.J.,Sut D.K. 2012. Fuzzy soft matrix theory and its decision making, *International Journal of modern Engineering Research*, 2, pp 121–127
- Cagman, N.,Enginoglu, S., 2010. Soft matrix theory and its decision making, *Computers and mathematics with applications* 59, 3308–3314.
- Kirişçi M. 2020. Medical Decision Making Resoect To The Fuzzy Soft Set
- Molodtsov, D., 1999. Soft set theory - First results. *Comput Math Appl* 37, 19–31
- Sezgin, A., Atagün, O. 2011. On operation of soft sets, *Comput. Math. Appl.*; 61(5): 1457-1467
- Yang, Y., Ji C. 2011. Fuzzy Soft Matrices and their applications, *AICI 2011, Part I, LNAI 7002* pp 618–627
- Zadeh, L.A. 1965. *Informs and control.*, 8 , pp. 338–353.

## Exploring Factors Influencing Cooperative Relationships Between Farmers and Cold Stores: A Statistical Analysis

Anjeza Bekolli<sup>1\*</sup>, Ina Pagria<sup>1</sup>

<sup>1</sup>Agricultural University of Tirana, Department of Mathematics and Informatics, 1025, Tirana, Albania

\*Corresponding author e-mail: abekolli@ubt.edu.al

### Abstract

*This study investigates the dynamics of cooperative relationships between farmers and cold stores in Albania's agricultural sector, focusing on the factors influencing long-term collaboration. Through linear regression analysis, the study investigates the impact of variables such as low purchase prices, reduced transportation costs, written contracts, improved market access and group compensation for stock goods on the cooperative dynamics between these cold stores and farmers. We also explore demographic characteristics such as gender distribution, age demographics, educational backgrounds, and business experience among both farmers and cold store operators, providing insights into the socio-economic context shaping these relationships.*

**Keywords:** Farmers, cold stores, collaboration

### INTRODUCTION

In the contemporary agricultural landscape, fostering cooperative relationships between farmers and cold stores is vital for ensuring the efficient distribution and preservation of agricultural produce. This study looks into what influences farmers' long-term cooperative connections with cold stores, as well as the latter's connections to one another. In the case of refrigerated warehouses, we are interested in the impact of factors such as a lower purchase price, a reduction in transport costs, written contracts with each other, and group compensation for the farmer's remaining stock product. And in the case of motivating the cooperation of farmers with cold stores, we aim to analyze the impact of factors such as saving costs, improving access to the market, and the written contract between them. The impact of the written contract factor has been established in both cases because, in recent years, frauds that have occurred due to a lack of legal evidence have not been rare in Albania. Thus, written contracts are one of the most important factors in having the longest and most successful cooperative relationships.

The study was done in the Albanian region of Korca, involving big apple-growing farms as well as significant cold storage facilities operating in the region. In this area, the farmers of this fruit are always facing more and more stock shortages of their product. In this situation, where the government's efforts to solve it are in minimalist conditions, we propose to make special cooperative contracts between farmers and cold stores for the compensation of the unsold product. Apparently, this proposal looks bad for cold stores, and they are not strong supporters of this initiative, but with the introduction of beneficial elements for cold stores as well: exclusivity in the sale of the product and making long-term contracts, they consider it an important factor. Analysing this and all the other factors mentioned, we aim to understand their importance in the lifespan of a collaboration in such a situation. Although the study case is special, it brings significant results for other situations that include a supplier of a product and several distributors that buy this product. This is because the factors themselves have been selected in such a way as to be comprehensive, since the goal is to see the impact that these factors have on long-term cooperative relations and not what factors influence the selected situation.



Through an examination of gender distribution, age demographics, educational backgrounds, and years of business experience among both farmers and cold stores, we seek to provide insights into the socio-economic context shaping these cooperative relationships. This study has relevance for policymakers, agricultural stakeholders, and researchers interested in optimizing supply chain management and increasing collaboration within the agricultural sector. In the article by (Breitenbach and Brandão, 2021) a similar study was done in Rio Grande de Sul (Brazil) with cooperator family farmers. Among the main aspects that contributed to the motivation of collaborations was precisely the purchase of products with the lowest cost, ease of marketing, and an increase in total profits.

Cooperation takes its true meaning when, in addition to the increase in the total income of the cooperation group, the individual income of the members also increases. This increase in the individual income of the members makes sense when the profits that each of them will receive will be greater than their profits if they acted alone in the market. Here we have one of the other problems faced by the challenges of successful cooperation, such as the sharing of benefits. The division of the total profit of the cooperation should be done using models that are based on criteria that motivate the cooperation. One of the most used models in the literature is the cooperative game theory (Von Neumann and Morgenstern, 1945), which is considered one of the most successful models for sharing profits in a cooperative situation. Applications of this model are in various fields, including those of water resources (Parrachino et al., 2006), (Akbari et al., 2015) in power system expansion planning (Churkin et al., 2021), in the chain of supply (Thun, 2005), (Guardiola et al., 2007), inventory management (Fiestras-Janeiro et al., 2011) the agriculture supply chain (Fang & Zhu, 2021), (Bekolli et al., 2023) etc. As for concrete applications in real life, they are in a smaller number due to the fact that the solutions offered by this model take into consideration all possible combinations of members, making the calculations more difficult. Among one of the most important applications of the cooperative game theory model in real life is that of (Engevall et al., 1998). As for the applications of this model in Albania, since our study is focused on this country, there are very few where we can mention the works (Kedhi and Bekolli, 2021) and (Bekolli and Pagria, 2022) which are focused on the agricultural sector for rewarding workers. This comparative analysis provides a fundamental investigation into the business characteristics and demography of cold storage facilities and farmers. It provides valuable information to participants in the industry, legislators, and agricultural researchers. Understanding the specific characteristics of these important players in the agricultural supply chain allows for the customization of support systems and interventions to meet particular needs, encourage teamwork, and improve the general sustainability and efficiency of agricultural operations. A total of 110 interviewees (all the big farmers and significant cold stores) were asked, including cold stores (CS) and farmers (F) who cultivate apple fruit in the area of Korca, Albania. Data processing and related analyses were done through the SPSS program and using the linear regression model.

The main objectives of this study are as follows:

- 1.Characterize Demographic and Business Profiles: Analyse the demographic data, educational backgrounds, age distributions, and business duration of farmers and cold store owners.
- 2.Investigate key determinants: Explore the impact of critical factors such as low purchase prices, reduced transportation costs, written contracts, and group compensation for stock goods on long-term cooperative relationships between farmers and cold stores.
- 3.Examine Market Access: Assess the influence of improved market access on cooperative dynamics, considering its role in facilitating collaboration and enhancing the efficiency of agricultural operations.
- 4.Analyze Contractual Agreements: Investigate the significance of written contracts in fostering trust, mitigating risks, and ensuring equitable distribution of benefits among stakeholders in the agricultural supply chain.

**METHODS AND PROCEDURES**

The methods employed for analysing the data in this study are primarily quantitative, utilizing statistical techniques such as linear regression analysis. The data collected from the survey conducted among cold store operators and farmers was processed using the Statistical Package for the Social Sciences (SPSS) software. Additionally, descriptive statistics were used to summarize and analyse the demographic information collected from both cold store operators and farmers. Descriptive statistics provide insights into the distribution, central tendency, and variability of demographic variables such as gender, age, education, and years of business experience. Linear regression analysis was chosen as the primary method to investigate the relationships between various independent variables (predictors) and the dependent variable (long-term cooperative relationships between farmers and cold stores). We have two hypotheses one for Cold stores and the other for farmers. In both case it is used regression linear to test them. The relationship between one or more independent variables (predictors) and a continuous dependent variable (outcome) can be modelled statistically using linear regression. The regress linear model is:  $Y = a_0 + a_1X_1 + a_2X_2 + \dots + a_nX_n + e$ , where  $Y$  is the dependent variable and  $X_1, X_2, \dots, X_n$  are the independent variables. The coefficients (parameters)  $a_0, a_1, a_2, \dots, a_n$  represent the relationship between each independent variable and the dependent variable, while “ $e$ ” is the error term representing unexplained variability. Next, we have a table that summarizes information for both types of interviewees, regarding gender, age, and education (table 1).

Table 1: Demographic information

	Frequency		Percent		Valid Percent		Cumulative Percent	
	CS	F	CS	F	CS	F	CS	F
<b>GENDER</b>								
Female	2	4	3.6	7.1	3.6	7.3	3.6	7.3
Male	53	51	96.4	91.1	96.4	92.7	100.0	100.0
Total	55	55	100.0	98.2	100.0	100.0		
Missing System				1.8				
Total				100.0				
<b>AGE</b>								
<b>35-44</b>	4	4	7.3	7.1	7.3	7.3	7.3	7.3
<b>45-54</b>	10	14	18.2	25.0	18.2	25.5	25.5	32.7
<b>55-64</b>	34	34	61.8	60.7	61.8	61.8	87.3	94.5
<b>Over 65</b>	7	3	12.7	5.4	12.7	5.5	100.0	100.0
Total	55	55	100.0	98.2	100.0	100.0		
Missing System		1		1.8				
Total		56		100.0				
<b>EDUCATION</b>								
<b>No education</b>	0	1	0	1.8	0	1.8	0	1.8
<b>Basic</b>	29	36	52.7	64.3	52.7	65.5	52.7	67.3
<b>High-School</b>	20	13	36.4	23.2	36.4	23.6	89.1	90.9
<b>Bachelor</b>	6	5	10.9	8.9	10.9	9.1	100.0	100.0
Total	55	55	100.0	98.2	100.0	100.0		
Missing System		1		1.8				
Total		56		100.0				

The demographic composition of both cold stores and farmers reveals interesting patterns. While the majority of cold store respondents were male (96.4%), a higher representation of female farmers (7.1%) was observed. Age distribution among cold store respondents indicates a prevalent presence of individuals aged 55-64 (61.8%), while farmers predominantly fell within the same age bracket (60.7%). Furthermore, educational attainment varied, with a significant portion of cold store operators possessing

basic education (52.7%), whereas farmers exhibited a more diverse educational background, ranging from basic (64.3%) to bachelor's degree (8.9%).

Understanding the longevity of engagement within their respective business provides valuable context (table 2). Cold store operators displayed a diverse range of business tenures, with over half (50.9%) having operated for over 15 years. In contrast, a larger proportion of farmers (67.9%) reported being engaged in their agricultural endeavors for over 15 years, highlighting a potentially deeper understanding of the agricultural landscape and market dynamics.

Table 2: Longevity information

	Frequency		Percent		Valid Percent		Cumulative Percent	
	CS	F	CS	F	CS	F	CS	F
<b>DURATION</b>								
<b>Less than 5 years</b>	2	1	3.6	1.8	3.6	1.8	3.6	1.8
<b>5-10 years</b>	3	1	5.5	1.8	5.5	1.8	9.1	3.6
<b>11-15 years</b>	22	15	40.0	26.8	40.0	27.3	49.1	30.9
<b>Over 15 years</b>	28	38	50.9	67.9	50.9	69.1	100.0	100.0
Total	55	55	100.0	98.2	100.0	100.0		
Missing System		1		1.8				
Total		56		100.0				

For the second and subsequent paragraphs, the beginning of the paragraph should be indented 0.5 cm. Body of text Body of text Body of text Body of text Body of text Body of text body of text (Author's Surname, 2021; Author's Surname and Author's Surname, 2021).

**Data Analyses**

In this paper, we have two hypotheses, one for cold stores and the other for farmers. In both cases, they have been tested using the linear regression method. In both cases, we have to see the impact of the factor on long-term cooperative relationships.

Cold store case:

The null hypothesis is Ho: Long-term cooperative relationships between cold stores do not depend on low purchase prices, reduced transportation costs, written contracts, or group compensation for stock goods for farmers.

The alternative hypothesis is Ha: Long-term cooperative relationships between cold stores depend on low purchase prices, reduced transportation costs, written contracts, or group compensation for stock goods for farmers.

In this case we have: Y-long-term cooperative relationships between cold stores,  $X_1$ -low purchase prices,  $X_2$ -reduced transportation costs,  $X_3$ -written contracts,  $X_4$ -group compensation for stock goods for farmers.

Farmers case:

The null hypothesis is Ho: Long-term cooperative relationships between farmers and cold stores do not depend on cost savings, improved market access, or written contracts.

The alternative hypothesis is Ha: Long-term cooperative relationships between farmers and cold stores depend on cost savings, improved market access, or written contracts.



**V. INTERNATIONAL APPLIED STATISTICS CONGRESS (UYIK - 2024)**  
**İstanbul / Türkiye, May 21-23, 2024**

In this case we have: Y- Long-term cooperative relationships between farmers and cold stores,  $X_1$ -Cost savings,  $X_2$ - Improved market access,  $X_3$ -Written contracts. From SPSS we have the following results for both cases.

**Model Summary**

Model	R	R Square	Adjusted R Square	Std. Error of the Estimate
CS	.403 <sup>a1</sup>	.162	.095	.838
F	.557 <sup>a2</sup>	.310	.270	.751

a1. Predictors: (Constant), low purchase prices, reduced transportation costs, written contracts, group compensation for stock goods for farmers.

a2. Predictors: (Constant), cost savings, improved market access, written contracts.

**ANOVA<sup>a1</sup>**

Model		Sum of Squares	df	Mean Square	F	Sig.
CS	Regression	6.805	4	1.701	2.422	.060 <sup>b</sup>
	Residual	35.122	50	.702		
	Total	41.927	54			

**ANOVA<sup>a2</sup>**

F	Regression	12.943	3	4.314	7.649	.000 <sup>b2</sup>
	Residual	28.766	51	.564		
	Total	41.709	54			

a1. Dependent Variable: long-term cooperative relationships between cold stores

b1. Predictors: (Constant), low purchase prices, reduced transportation costs, written contracts, group compensation for stock goods for farmers.

a2. Dependent Variable: long-term cooperative relationships between farmers and cold stores

b2. Predictors: (Constant), cost savings, improved market access, written contracts

**Coefficients<sup>a</sup>**

Model		Unstandardized Coefficients		Standardized Coefficients	t	Sig.
		B	Std. Error	Beta		
CS	(Constant)	4.877	1.062		4.592	.000
	Low purchase prices	-.061	.164	-.049	-.372	.712
	Reduced transportation costs	-.224	.148	-.198	1.514	.136
	Written contracts	.406	.184	.292	2.204	.032
	Group compensation for stock goods for farmers	-.186	.144	-.172	1.295	.201
<b>Coefficients<sup>a2</sup></b>						
F	(Constant)	2.536	.765		3.315	.002
	Cost savings	-.100	.151	-.079	-.660	.512
	Improved market access	.587	.152	.471	3.870	.000
	Written contracts	.245	.158	.189	1.550	.127

a1. Dependent Variable: long term-cooperative relationships between cold stores

a2. Dependent Variable: long term-cooperative relationships between farmers and cold stores

### Interpretation of the results

The regression model for cold stores case is as follows:

$Y=4.877-0.961X_1-0.224X_2+0.406X_3-0.186X_4+e$ . We notice that only the factor of written contracts has a positive impact, while the other three have a negative impact on long-term cooperative relationships between cold stores. The coefficient for written contracts ( $a_3$ ) is 0.406 means that holding all other variables constant, a one-unit increase in the presence of written contracts is associated with an increase of approximately 0.406 units in the long-term cooperative relationships between cold stores. The p-value for this coefficient is 0.032, indicating that it is statistically significant at the conventional significance level of 0.05. The coefficient of determination ( $R^2$ ) represents the proportion of variance in the dependent variable that is explained by the independent variables. Here,  $R^2$  is 0.162, indicating that approximately 16.2% of the variability in the long-term cooperative relationships between cold stores can be explained by the predictors included in the model. From the ANOVAa1 table, we see that  $F_{\text{factic}}=2.433$ . With 95% certainty and with degrees of freedom 4 and 50, we find the critical value from Fisher's table and compare them with each other.  $F_{\text{critic}}=F_{\alpha,(k-1):(n-k)}=F_{0.05;4;50}=2.37$ . The factual value turned out to be greater than the critical one, which means that the basic hypothesis falls down; the alternative one remains, that is, that long-term cooperation relationships depend on the low purchase price, on the reduction of transport costs, on written contracts, and on group compensation for stock goods to farmers.

The regression model for farmers resulted as follows:  $Y=2.536-0.100X_1+0.587X_2+0.245X_3+e$ . We notice that only the factor of cost savings has a negative impact, while the other three have a positive impact on long-term cooperative relationships between farmers and cold stores. Here,  $R^2$  is 0.310, indicating that approximately 31.0% of the variability in the long-term cooperative relationships between farmers and cold stores can be explained by the predictors included in the model. From the ANOVAa1 table, we see that  $F_{\text{factic}}=7.649$ . With 95% certainty and with degrees of freedom 3 and 51, we find the critical value from Fisher's table and compare them with each other.  $F_{\text{critic}}=F_{\alpha,(k-1):(n-k)}=F_{0.05;3;51}=2.60$ . The actual value turned out to be greater than the critical one, which means that the basic hypothesis falls down; the alternative one remains, that is, that long-term cooperation relationships depend on cost savings, improving access to the market, and written contracts.

### DISCUSSION AND CONCLUSION

The study yields significant insights into the demographic composition and business profiles of both cold store operators and farmers. Notably, cold store operators exhibit a predominantly male demographic, with a substantial proportion possessing basic education. In contrast, farmers demonstrate a more diverse educational background, ranging from basic to bachelor's degrees. Furthermore, a considerable portion of cold store operators and farmers have been engaged in their respective businesses for over 15 years, highlighting their extensive experience and deep-rooted involvement in the agricultural sector. Regarding the determinants of cooperative relationships, findings indicate that written contracts play a pivotal role in enhancing collaboration between cold stores and farmers, positively influencing long-term cooperative dynamics. Conversely, factors such as low purchase prices and reduced transportation costs exhibit negative impacts on cooperative relationships among cold store operators. For farmers, cost savings, improved market access, and written contracts emerge as significant drivers of sustainable cooperation with cold stores, emphasizing the importance of contractual agreements and market access in fostering mutually beneficial partnerships within the agricultural supply chain.

## References

- Akbari N, Hossein N. M, Ardestani M, 2015. OPTIMIZATION OF WATER ALLOCATION USING COOPERATIVE GAME THEORY CASE STUDY: ZAYANDEHRUD BASIN. *Journal of Environmental Studies*, 40(4), 10–12. [https://www.sid.ir/en/VEWSSID/J\\_pdf/80620150404.pdf](https://www.sid.ir/en/VEWSSID/J_pdf/80620150404.pdf)
- Bekolli A, Guardiola L. A, Meca A, 2023. Profit allocation in agricultural supply chains: exploring the nexus of cooperation and compensation. *arXiv (Cornell University)*. <https://doi.org/10.48550/arxiv.2307.11065>
- Bekolli A, Pagria, I, 2022. RELATIONSHIPS BETWEEN SUBSET AND ONE-POINT SOLUTIONS IN COOPERATIVE GAME THEORY: A WORKER COMPENSATION APPLICATION. *International Journal of Academic Research and Reflection*, 10(4).
- Breitenbach R, Brandão J. B, 2021. Factors that contribute to satisfaction in cooperator-cooperative relationships. *Land Use Policy*, 105, 105432. <https://doi.org/10.1016/j.landusepol.2021.105432>
- Churkin A, Białek J, Pozo D, Sauma E, Korgin N, 2021. Review of Cooperative Game Theory applications in power system expansion planning. *Renewable & Sustainable Energy Reviews*, 145, 111056. <https://doi.org/10.1016/j.rser.2021.111056>
- Engvall S, Göthe-Lundgren M, Värbrand P, 1998. The traveling salesman game: An application of cost allocation in a gas and oil company. *Annals of Operations Research*, 82, 453–472. <https://doi.org/10.1023/a:1018935324969>
- Fang Z, Zhu C, 2021. Distribution of the benefits of agricultural supply chain cooperation based on interval-valued least-squares pre-nucleolus solutions. *Journal of Physics: Conference Series*, 1800(1), 012005. <https://doi.org/10.1088/1742-6596/1800/1/012005>
- Fiestras-Janeiro M. G, García-Jurado I, Meca A, Mosquera M. A, 2011. Cooperative game theory and inventory management. *European Journal of Operational Research*, 210(3), 459–466. <https://doi.org/10.1016/j.ejor.2010.06.025>
- Guardiola L. A, Meca A, Timmer J. B, 2007. Cooperation and profit allocation in distribution chains. *Decision Support Systems*, 44(1), 17–27. <https://doi.org/10.1016/j.dss.2006.12.015>
- Kedhi V, Bekolli A, 2021. Profit distribution in some agricultural employment situations. *Journal of Economy and Agribusiness/FEA*, 15(1).
- Parrachino I, Dinar A, Patrone F, 2006. Cooperative Game Theory and its Application to Natural, Environmental, and Water Resource issues : 3. Application to Water resources. In *World Bank policy research working paper*. <https://doi.org/10.1596/1813-9450-4074>
- Thun J, 2005. The potential of Cooperative game Theory for Supply chain Management. In *Physica-Verlag eBooks* (pp. 477–491). [https://doi.org/10.1007/3-7908-1636-1\\_31](https://doi.org/10.1007/3-7908-1636-1_31)
- Von Neumann, J., & Morgenstern, O. (1945). Theory of games and economic behavior. *The Journal of Philosophy*, 42(20), 550. <https://doi.org/10.2307/2019327>

## Conflict of Interest

"The authors have declared that there is no conflict of interest"



## C550 Tip Kumarin Modifiye Elektrotların Sürekapasitör Uygulamalarına Yönelik Hesaplamalı Optimizasyonu

Ümit Bektaş<sup>1</sup>, Afike Ayça Özen<sup>1</sup>, Oğuz Akpolat<sup>1</sup>, Atilla Eren Mamuk<sup>2</sup>, Sema Aslan<sup>1\*</sup>

<sup>1</sup> Muğla Sıtkı Koçman University, Faculty of Science, Chemistry Department, 48000, Muğla, Türkiye

<sup>2</sup> Muğla Sıtkı Koçman University, Faculty of Science, Physics Department, 48000, Muğla, Türkiye

\*Sorumlu yazar e-mail: sozcan87@gmail.com

### Özet

Süperkapasitör çalışmalarında kullanılmak üzere geliştirilecek olan kumarin temelli karbon elektrotların ön optimizasyonları için hesaplamalı çalışmalardan faydalanılmıştır. Tür olarak C550 kodlu kumarin kullanılarak hazırlanan farklı derişimlerdeki çözeltilerin camımsı karbon pasta elektrot (GCPE) yapısına katkıları araştırılmıştır. Bu amaçla yapılan uygulamaların seri ölçümleri ve uygulanan kumarin miktarları metin içinde detaylı olarak verilmiştir. Yöntem olarak differansiyel puls voltmetrisi ve kompozit dizayn iki faktörlü ve iki seviyeli olarak uygulanmıştır. Tarama hızı ( $X_1$ : mV/sec) ve Konsantrasyon ( $X_2$ :  $\mu$ L) faktörlerinin optimum 155 ve 5.5 olduğu bulunmuştur. Bu çalışma neticesinde daha kısa sürede daha az kimyasal sarfiyatı ile optimum sonuca ulaşılmıştır.

**Anahtar Kelimeler:** Kumarin, Kompozit Dizayn, Süperkapasitörler, Elektrokimya

### Abstract

Programmatic expansion was used for the preliminary properties of coumarin alternative carbon electrodes to be developed for use in supercapacitor studies. Glassy carbon pasta electrode (GCPE) additives of solutions at different concentrations applied using coumarin coded C550 as a species were investigated. The serial measurements made for this purpose and the amounts of coumarin applied are given in detail in the text. As a method, different pulse voltmeter and composite design are designed as two-factor and two-level. Scanning speed ( $X_1$ : mV/sec) and Concentration ( $X_2$ :  $\mu$ L) values are optimum at 155 and 5.5. As a result of this study, optimum was achieved with less chemical consumption in a shorter time.

**Keywords:** Coumarin, Composite Design, Supercapacitors, Electrochemistry

### GİRİŞ

Lakton olarak bilinen kumarin (2H-1-Benzopyran-2-one), benzopiron yapısı nedeniyle son derece ilginç elektrokimyasal ve spektroeletrokimyasal özellikler sağlar (Krishnan 2020). Çok aktif yalnız elektron çiftlerine ev sahipliği yapan bitişik hidrojen atomları ve her iki oksijen atomu, elektrokimyasal işlem altında kolayca indirgenmeye veya yükseltgenmeye maruz kalır veya iletken polimerler için yararlı bir deęiştirici olarak hizmet edebilir (Yiğit 2014). Kumarin veya türevleri Perkin, Pechman veya Kostanecki reaksiyonları ile sentezlenebilir ve çeşitli bitkilerde doğal olarak laktonizasyon reaksiyonu ile üretilir (Bye ve King 1970). Kokusu ve tadı hayvanlar için allelopati ajanı görevi görmektedir ve çok çeşitli gıdalarda kumarin bulunmaktadır (Wang 2013). Tıp uygulamalarında Warfarin adı ile antikoagülasyon ajanı olarak (Leal 2000), kemirgen tedavisinde 4-hidroksikumarin olarak sıçan gibi yırtıcı hayvanlardan korunmak için (Born 2003), gıda veya parfümlerde lezzet verici veya aromatize edici olarak kullanılmıştır. Kokusu büyük olasılıkla vanilyaya benzemektedir (Wang 2013), ancak kumarinin aşırı konsantrasyonları canlı organizmalarda çok fazla kusura neden olmaktadır (Marles 1986; Wesseling 2001). Kumarinin ana uygulamaları yoğun olarak boya lazer endüstrisine (Costela, 1996) ve sahip olduğu yüksek kromojenik yapı nedeniyle özellikle güneş enerjisi paneli ve OLED'lere dayanmaktadır (Sarmah 2022, Kalay 2020).

Süperkapasitör, enerjiyi polarize elektrolitle depolamak için 1970'li ve 1980'li yıllarda geliştirilen elektrokimyasal bir cihazdır. Geleneksel kimyasal güç kaynağından farklıdır. Geleneksel kapasitörler ve piller arasında performansla sahip bir tür cihazdır (Boicea vd., 2014). Kumarin katkılı süperkapasitörlerden elde edilen şarj depolama performansının oldukça arttığı daha önceki çalışmalarda

bildirilmiştir (Mamuk vd., 2022)

Burada ilk olarak bir kumarin türü olan (C550) ile camımsı karbon pasta elektrot (GCPE)'nin nötral ortamda çalıştırılacak olan süperkapasitörler için kompozit dizayn iki faktörlü ve iki seviyeli hesaplama ile miktar optimizasyonu üzerine çalışılmıştır. Bu çalışma neticesinde elde edilen verilerden faydalanılarak ileri ölçümlere geçilecektir. Bu çalışma daha kapsamlı bir çalışmanın ön ayağıdır, ve hesaplamalı çalışmaların süperkapasitörler alanında etkin kullanımına güzel bir örnektir. Elektrokimyasal karakterizasyonlarda differansiyel puls voltammetrisi (DPV) kullanılmıştır.

## MATERYAL VE METOD

### Materyal

Potasyum dihidrojen fosfat ( $\text{KH}_2\text{PO}_4$ ), potasyum klorür (KCl),  $\text{K}_3\text{Fe}[\text{CN}]_6$ ,  $\text{K}_4[\text{Fe}(\text{CN})_6] \cdot 3\text{H}_2\text{O}$ , Dimetilformamid (DMF) (%99,80) Sigma-Aldrich'ten satın alınmıştır. Elektrokimyasal ölçümler için Autolab PGSTAT 204 potansiyostat/galvanostat (Metrohm) kullanıldı. Elektrokimyasal ölçümler için NOVA 2.1.4 yazılımı kullanıldı. Öncelikle C550 'nin DMF içerisindeki stok çözeltileri 1 mg/mL derişiminde hazırlandı. Bu stoktan 100 µl alınarak tekrar DMF ile 1 mL'ye tamamlanmıştır. Bu stoktan alınan miktarlar aşağıda Çizelge 1'de verilmiştir. Çizelgede verilen miktarlardaki çözeltiler yalnız GCPE elektrot yüzeyine uygulanmıştır. Yalnız GCPE kompozit elektrotlar %80 camımsı karbon tozu ve %20 mineral yağ kullanılarak oluşturulan pasta karışımının bir elektrot gövdesine yerleştirilmesiyle oluşturulmaktadır. 50 mM fosfat tampon tuzlu çözeltisi (PBS)  $\text{KH}_2\text{PO}_4$  ve 0,1 M KCl içerecek şekilde hazırlandı. Hazırlanan PBS kullanılarak 5 mM  $\text{K}_3\text{Fe}[\text{CN}]_6$  ve  $\text{K}_4[\text{Fe}(\text{CN})_6] \cdot 3\text{H}_2\text{O}$ , içerecek şekilde prob çözelti hazırlandı. Bu çözelti elektrolit olarak üçlü elektrot sistemi kullanılan hücreye 10 mL eklendi. C550 modifiye GCPE elektrotlar çalışma elektrodu, Ag/AgCl referans elektrot ve Pt levha karşıt elektrot olarak kullanıldı. Tüm kimyasallar analitik saflıktaydı ve daha fazla saflaştırılmadan alındığı gibi kullanılmıştır.

### Metod

#### Verilerin Toplanması

Yalnız ve C550 modifiye GCPE elektrotların ölçümleri -0.2 ila 1 Volt aralığında potansiyel uygulanarak farklı tarama hızlarının ölçümler üzerindeki etkisi DPV yöntemi uygulanarak ölçülmüştür. Alınan ölçümler neticesinde elde edilen akım değerleri Çizelge 1'de verilmiştir. Ayrıca elde edilen voltammogramlar Şekil 1'de toplu olarak verilmiştir.

#### İstatistiksel Analizler

Deneyisel çalışma faktörleri olan Scan Speed ( $X_1$ : mV/sec) ve Concentration ( $X_2$ : µL) nun optimizasyonunda deney tasarım modeli olarak CCD (Centrale Composite Design) seçilmiş olup Response (Cevap) olarak Current ( $Y$ : µA) ölçülmüştür. Burada deney sayısı **Experiment Number**= $2^k+2k+(\text{Repetition})=1=2^2+2*2+(5)=13$  adet olarak bu model ( $\alpha=\pm 1.2671$ ) için hesaplanmıştır. Faktörlerin çalışma aralıkları daha önceki deneyimler çerçevesinde **Scan Speed** için 50/250 ve **Concentration** için 1/10 olarak belirlenmiş olup deneysel faktörlere bağlı olarak ölçülen Akım (Current) değerleri Tablo X'de verilmiştir. Tüm hesaplamalar ve değerlendirmeler Design-Expert 7 programında gerçekleştirilmiştir.

## SONUÇLAR

Aşağıda elektrokimyasal ölçümler sonunda elde edilen DPV voltammogramları iki kısımda sunulmuştur. Şekil 1.'de, Çizelge 1.'de bulunan standartlara ait ölçüm değerleri uygulanarak elde edilen voltammogramlar karşılaştırılmıştır. Ölçümler C550 modifiye ve C550 içermeyen GCPE elektrotlar kullanılarak üçlü elektrot sistemi kullanılarak alınmıştır.

CCD\_2\_Par\_00\_Sca\_Con\_Env\_Alp\_1\_2671\_Na2SO4\_2.doc

CCD\_2\_Par\_00\_Sca\_Con\_Env\_Alp\_1\_2671\_Na2SO4\_2.dx7

CCD\_2\_Par\_00\_Sca\_Con\_Env\_Alp\_1\_2671\_Na2SO4\_2.xls

Current (Microampere), Voltage (Volt), Resistance (Ohm), Material: GCPE, Acidity: pH=10

Env: KoH: KOH, Na2: Na<sub>2</sub>SO<sub>4</sub>

**V. INTERNATIONAL APPLIED STATISTICS CONGRESS (UYIK - 2024)**  
**İstanbul / Türkiye, May 21-23, 2024**

Current: (Current Magnitude =(-0.2 V, → +1 V)

Coumarin: (Solution Concentration =1-10 µL)

Parameter=2 (k) Alp: Alpha= (Rotatable (k<6)=±1.41421, Spherical=±1.41421, Orthogonal=±1.2671, Practical (k>5)= ±1.18921, Face=±1, Other=2)

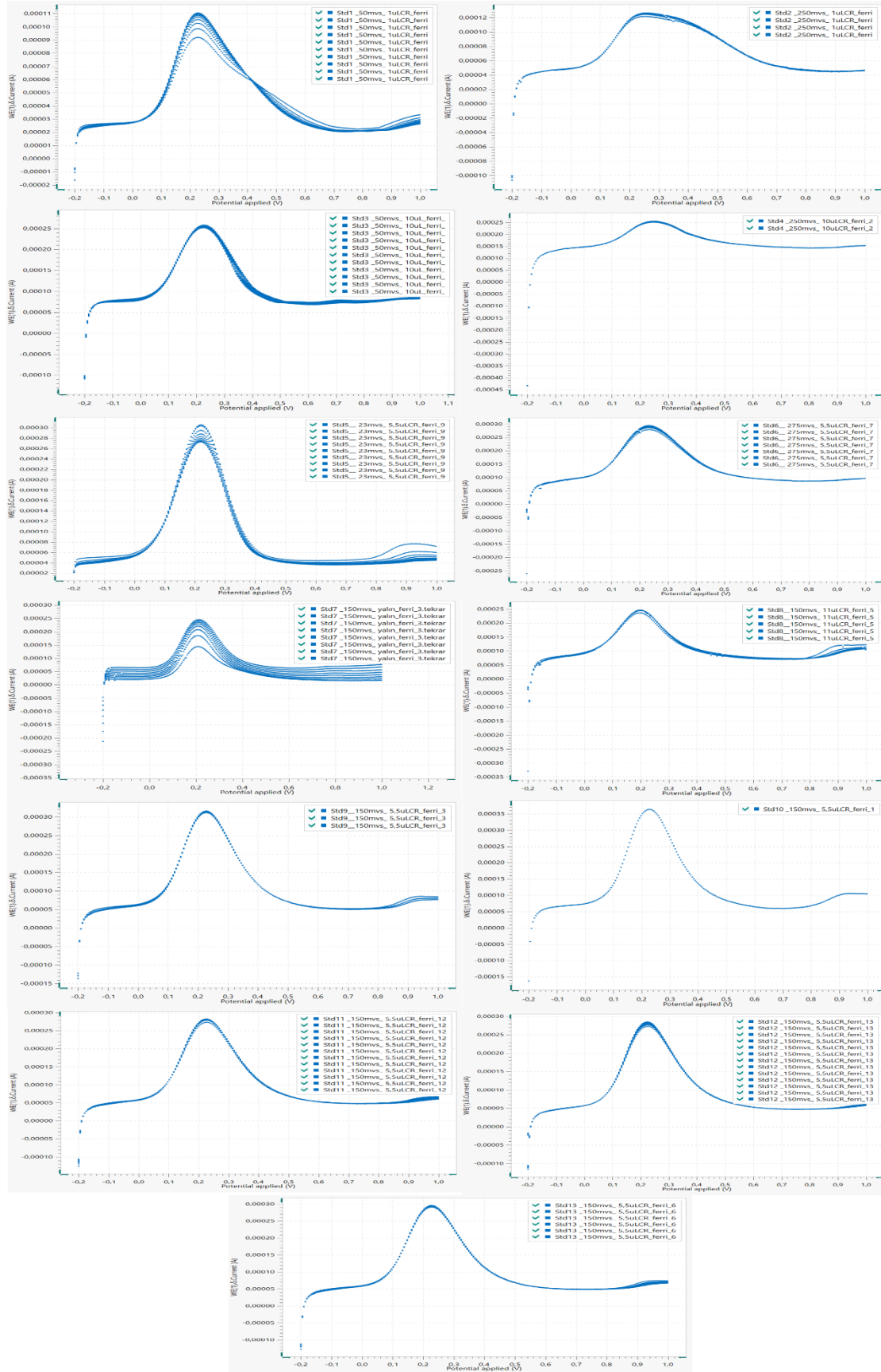
Name	Units	-1 Level	+1 Level	-alpha	+alpha
Scan Speed	mV/sec	50	250	-1.2671	1.2671
Concentration	µg/L	1	10	-1.2671	1.2671
<b>CCD_2_Par_00_Sca_Con_Env_Alp</b>	<b>Env= KoH or Na2</b>			<b>Lower</b>	<b>Upper</b>
<b>Scan Speed</b>	<b>mV/sec</b>			<b>50</b>	<b>250</b>
<b>Concentration</b>	<b>µg/L</b>			<b>1</b>	<b>10</b>
<b>RESPONSE</b> (Alp=±1.41421)	<b>(Current)</b>			<b>µA</b>	<b>-</b>
<b>CCD (Centrale Composite Design) Experiment Number=2<sup>k</sup>+2k+(Repetition)=1=2<sup>2</sup>+2*2+(5)=13</b>					
<b>Current</b>	<b>µA</b>	<b>-</b>	<b>-</b>		

**Çizelge 1.** Deneyde kullanılan değişkenler ve standart değerleri

Std	Run	Block	Factor 1	Factor 2	Response 1
			A:Scan Speed	B:Concentration	Current
			mV/sec	µg/L	µA
1	7	Block 1	50	1	85.7
2	5	Block 1	250	1	80.4
3	2	Block 1	50	10	184.3
4	8	Block 1	250	10	126.5
5	1	Block 1	23	5.5	248.5
6	6	Block 1	275	5.5	217.9
7	9	Block 1	150	0	183.2
8	4	Block 1	150	11	173.2
9	12	Block 1	150	5.5	262.9
10	3	Block 1	150	5.5	245.0
11	10	Block 1	150	5.5	233.9
12	13	Block 1	150	5.5	234.6
13	11	Block 1	150	5.5	245.4



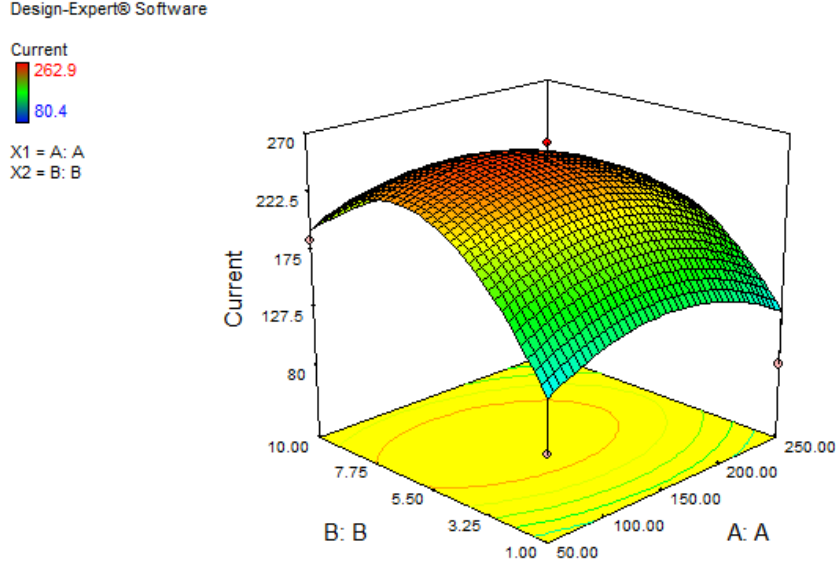
V. INTERNATIONAL APPLIED STATISTICS CONGRESS (UYİK - 2024)  
İstanbul / Türkiye, May 21-23, 2024



Şekil 1. Standart 1 ile 13 için yapılan ölçümler sonucunda elde edilen DPV voltammogramları.

Çizelge 2. Cevap yüzey fonksiyonunun çözüm katsayıları

$b_0$	$b_1$	$b_2$	$b_{12}$	$b_{11}$	$b_{22}$
+44.26126	+0.98550	+47.96904	-0.029167	$-3.23522 \cdot 10^{-00335}$	-3.58009



Şekil 2. Analiz sonuç diyagramı

#### TARTIŞMA VE SONUÇ:

Deneyel çalışma faktörleri olan Scan Speed ( $X_1$ : mV/sec) ve Concentration ( $X_2$ :  $\mu\text{g/L}$ ) nun optimizasyonunda deney tasarım modeli olarak CCD (Centrale Composite Design) seçilmiş olup Response (Cevap) olarak Current ( $Y$ :  $\mu\text{A}$ ) ölçülmüştür. Burada deney sayısı **Experiment Number**  $= 2^k + 2k + (\text{Repetition}) = 1 + 2^2 + 2 \cdot 2 + (5) = 13$  adet olarak bu model ( $\alpha = \pm 1.2671$ ) için hesaplanmıştır. Faktörlerin çalışma aralıkları daha önceki deneyimler çerçevesinde **Scan Speed** için 50/250 ve **Concentration** için 1/10 olarak belirlenmiş olup deneysel faktörlere bağlı olarak ölçülen Akım (Current) değerleri Çizelge 1’de verilmiştir. Tüm hesaplamalar ve değerlendirmeler Design-Expert 7 programında gerçekleştirilmiştir. Deneyel verilerin optimizasyonuna ilişkin önerilen cevap yüzey fonksiyonu (Kvadratik Model):

$$Y = b_0 + b_1 X_1 + b_2 X_2 + b_{12} X_1 X_2 + b_{11} X_1^2 + b_{22} X_2^2$$

şeklinde olup, burada  $R^2$  (Eğri Yüzeyin Deneyel Noktalara Uyumu) en az 0,90 dır ve Cevap Yüzey Fonksiyonunun Çözüm Katsayıları Çizelge 2’de sunulmuştur. Çözümleme için en küçük kareler metodu kullanılmıştır.

Şekil 2. ve Çizelge 2’den de anlaşılacağı gibi en yüksek değerinde (263  $\mu\text{A}$ ) Scan Speed ( $X_1$ : mV/sec) ve Concentration ( $X_2$ :  $\mu\text{g/L}$ ) faktörlerinin optimum 155 ve 5.5 olduğu anlaşılmaktadır.

#### References

- Krishnan, R. G.; Saraswathyamma, B. Disposable Electrochemical Sensor for Coumarin Induced Milk Toxicity in Raw Milk Samples. Measurement 2021, 170, 108709.
- Yiğit, D.; Udum, Y. A.; Güllü, M.; Toppare, L. Electrochemical and Spectroelectrochemical Studies of Poly(2,5-Di-2,3-Dihydrothieno[3,4- b][1,4]Dioxin-5-Ylthienyl) Derivatives Bearing Azobenzene, Coumarine and Fluorescein Dyes: Effect of Chromophore Groups on Electrochromic Properties. Electrochim. Acta 2014, 147, 669–677.
- Bye, A.; King, H. K. The Biosynthesis of 4-Hydroxycoumarin and Dicoumarol by Aspergillus Fumigatus Fresenius. Biochem. J. 1970, 117 (2), 237–245.

- Wang, Y.-H.; Avula, B.; Nanayakkara, N. P. D.; Zhao, J.; Khan, I. A. Cassia Cinnamon as a Source of Coumarin in Cinnamon-Flavored Food and Food Supplements in the United States. *J. Agric. Food Chem.* 2013, 61 (18), 4470–4476.
- Leal, L. K. A.; Ferreira, A. A.; Bezerra, G.; Matos, F. J.; Viana, G. S. Antinociceptive, Anti-Inflammatory and Bronchodilator Activities of Brazilian Medicinal Plants Containing Coumarin: A Comparative Study. *J. Ethnopharmacol.* 2000, 70 (2), 151–159.
- Born, S. L.; Api, A. M.; Ford, R. A.; Lefever, F. R.; Hawkins, D. R. Comparative Metabolism and Kinetics of Coumarin in Mice and Rats. *Food Chem. Toxicol.* 2003, 41 (2), 247–258.
- Marles, R. J.; Compadre, Cé. M.; Farnsworth, N. R. Coumarin in Vanilla Extracts: Its Detection and Significance. *Econ. Bot.* 1987, 41 (1), 41–47.
- Wesseling, J.; Van Driel, D.; Smrkovsky, M.; Van der Veer, E.; Geven-Boere, L.; Sauer, P. J.; Touwen, B. C. Neurological Outcome in School-Age Children after in Utero Exposure to Coumarins. *Early Hum. Dev.* 2001, 63 (2), 83–95.
- Costela, A.; Garcia-Moreno, I.; Figuera, J. M.; Amat-Guerri, F.; Barroso, J.; Sastre, R. Solid-State Dye Laser Based on Coumarin 540A Doped Polymeric Matrices. *Opt. Commun.* 1996, 130 (1–3), 44–50.
- Sarmah, M.; Chutia, K.; Dutta, D.; Gogoi, P. Overview of Coumarin-Fused-Coumarins: Synthesis, Photophysical Properties and Their Applications. *Org. Biomol. Chem.* 2021, 20 (1), 55–72.
- Kalay, H.; Yiğit, D.; Hizalan, G.; Güllü, M.; Depci, T.; Cirpan, A.; Toppare, L.; Hacıoğlu, S. O. Synthesis, Electrochromic Characterization and Solar Cell Application of Thiophene Bearing Alternating Copolymers with Azobenzene and Coumarin Subunits. *J. Macromol. Sci. Part A* 2020, 57 (8), 589–599.
- Boicea, V. A. (2014). Energy storage technologies: The past and the present. *Proceedings of the IEEE*, 102(11), 1777-1794.
- Mamuk, A. E., Koçak, C., Aslan, S., & Bal Altuntaş, D. (2022). Electrochemical properties of coumarin 500 encapsulated in a liquid crystal guided electrospun fiber core and their supercapacitor application. *ACS Applied Energy Materials*, 5(10), 12078-12089.

**Conflict of Interest**

"The authors have declared that there is no conflict of interest".



## C540 Tip Kumarin Modifiye Elektrotların Süperkapasitör Uygulamalarına Yönelik Hesaplamalı Optimizasyonu

**Afike Ayça Özen<sup>1</sup>, Ümit Bektaş<sup>1</sup>, Oğuz Akpolat<sup>1</sup>, Atilla Eren Mamuk<sup>2</sup>, Sema Aslan<sup>1\*</sup>**

<sup>1</sup> Muğla Sıtkı Koçman University, Faculty of Science, Chemistry Department, 48000, Muğla, Türkiye

<sup>2</sup> Muğla Sıtkı Koçman University, Faculty of Science, Physics Department, 48000, Muğla, Türkiye

\*Sorumlu yazar e-mail: sozcan87@gmail.com

### Özet

*Kumarin modifiye süperkapasitör çalışmalarında enerji verimliliğinin arttığı bilinmektedir. Bu çalışmada da kumarin C540 katkılı bir EDLC türü süperkapasitör geliştirmek üzere optimizasyon çalışmalarına yer verilmiştir. Tür olarak C540 kodlu kumarin kullanılarak hazırlanan farklı derişimlerdeki çözeltilerin camımsı karbon pasta elektrot (GCPE) yapısına katkıları araştırılmıştır. Bu amaçla yapılan uygulamaların seri ölçümleri ve uygulanan kumarin miktarları metin içinde detaylı olarak verilmiştir. Yöntem olarak differansiyel puls voltammetrisi ve kompozit dizayn iki faktörlü ve iki seviyeli olarak uygulanmıştır. Tarama hızı ( $X_1$ : mV/sec) ve Konsantrasyon ( $X_2$ :  $\mu$ L) faktörlerinin optimum 23 ve 5.5 olduğu bulunmuştur. Bu çalışma neticesinde daha kısa sürede daha az kimyasal sarfiyatı ile optimum sonuca ulaşılmıştır.*

**Anahtar Kelimeler:** Kumarin, Kompozit Dizayn, Süperkapasitörler, Elektrokimya

### Abstract

*It is known that energy efficiency increases in coumarin modified supercapacitor studies. In this study, optimization studies were included to develop an EDLC type supercapacitor with coumarin C540 doping. The contributions of solutions at different concentrations prepared using coumarin coded C540 as a species to the glassy carbon paste electrode (GCPE) structure were investigated. Serial measurements of the applications made for this purpose and the amounts of coumarin applied are given in detail in the text. As methods, differential pulse voltammetry and composite design were applied with two factors and two levels. Scanning speed ( $X_1$ : mV/sec) and Concentration ( $X_2$ :  $\mu$ L) factors were found to be optimum 23 and 5.5. As a result of this study, optimum results were achieved with less chemical consumption in a shorter time.*

**Keywords:** Coumarin, composite design, supercapacitors, electrochemistry

### GİRİŞ

Kumarinler benzopiron ailesinin bir üyesi olarak sınıflandırılır. Bunların tümü bir piron halkasına bağlı bir benzen halkasından oluşur. Benzopironlar, kumarinlerin ait olduğu benzo-alfa-pironlara ve flavonoidlerin ana üyeleri olduğu benzo-gama-pironlara bölünebilir. Umbelliferone, esculetin ve scopoletin doğada en yaygın bulunan kumarinlerdir. Bu bileşiklerin sentezi sırasında orto-hidroksilasyonun sırasıyla p-kumarik, kafeik ve ferulik asit üzerinde gerçekleşmesi gerekir. Kumarinler farmakolojik özelliklerinden dolayı büyük ilgi görmektedir. Özellikle fizyolojik, bakteriyostatik ve anti-tümör aktiviteleri, bu bileşikleri yeni terapötik ajanlar olarak omurga türetme ve tarama açısından çekici kılmaktadır (Egan vd., 1990; Jain vd., 2012; Peng vd., 2013)

Süperkapasitör, enerjiyi polarize elektrolitle depolamak için 1970'li ve 1980'li yıllarda geliştirilen elektrokimyasal bir cihazdır. Geleneksel kimyasal güç kaynağından farklıdır. Geleneksel kapasitörler ve piller arasında performansa sahip bir tür cihazdır (Boicea vd., 2014). Kumarin katkılı süperkapasitörlerden elde edilen şarj depolama performansının oldukça arttığı daha önceki çalışmalarda bildirilmiştir (Mamuk vd., 2022).

Sunulan çalışmada bir kumarin türü olan C540 ile camımsı karbon pasta elektrot (GCPE)'nin bazik ve nötral ortamda denenecek olan süperkapasitörler için kompozit dizayn iki faktörlü ve iki seviyeli

hesaplama ile miktar optimizasyonu üzerine çalışılmıştır. Bu çalışma neticesinde elde edilen verilerden faydalanılarak ileri ölçümlere geçilecektir. Bu çalışma daha kapsamlı bir çalışmanın ön ayağıdır, ve hesaplamalı çalışmaların süperkapasitörler alanında etkin kullanımına güzel bir örnektir. Elektrokimyasal karakterizasyonlarda differansiyel puls voltammetrisi (DPV) kullanılmıştır.

## MATERYAL VE METOD

### Materyal

Potasyum dihidrojen fosfat ( $\text{KH}_2\text{PO}_4$ ), potasyum klorür (KCl),  $\text{K}_3\text{Fe}[\text{CN}]_6$ ,  $\text{K}_4[\text{Fe}(\text{CN})_6] \cdot 3\text{H}_2\text{O}$ , Dimetilformamid (DMF) (%99,80) Sigma-Aldrich'ten satın alınmıştır. Elektrokimyasal ölçümler için Autolab PGSTAT 204 potansiyostat/galvanostat (Metrohm) kullanıldı. Elektrokimyasal ölçümler için NOVA 2.1.4 yazılımı kullanılmıştır. Öncelikle C540 'nin DMF içerisindeki stok çözeltileri 1 mg/mL derişiminde hazırlanmıştır. Bu stoktan 100 µl alınarak tekrar DMF ile 1 mL'ye tamamlanmıştır. Bu stoktan alınan miktarlar aşağıda Çizelge 1 'de verilmiştir. Çizelgede verilen miktarlardaki çözeltiler yalnız GCPE elektrot yüzeyine uygulanmıştır. Yalnız GCPE kompozit elektrotlar %80 camımsı karbon tozu ve %20 mineral yağ kullanılarak oluşturulan pasta karışımının bir elektrot gövdesine yerleştirilmesiyle oluşturulmaktadır. 50 mM fosfat tampon tuzlu çözeltisi (PBS)  $\text{KH}_2\text{PO}_4$  ve 0,1 M KCl içerecek şekilde hazırlanmıştır. Hazırlanan PBS kullanılarak 5 mM  $\text{K}_3\text{Fe}[\text{CN}]_6$  ve  $\text{K}_4[\text{Fe}(\text{CN})_6] \cdot 3\text{H}_2\text{O}$ , içerecek şekilde prob çözelti hazırlanmıştır. Bu çözelti elektrolit olarak üçlü elektrot sistemi kullanılan hücreye 10 mL eklenmiştir. C540 modifiye GCPE elektrotlar çalışma elektrodu, Ag/AgCl referans elektrot ve Pt levha karşıt elektrot olarak kullanılmıştır. Tüm kimyasallar analitik saflıktadır ve daha fazla saflaştırılmadan alındığı gibi kullanılmıştır.

### Metod

#### Verilerin Toplanması

Yalnız ve C540 modifiye GCPE elektrotların ölçümleri -0.2 ila 1 Volt aralığında potansiyel uygulanarak farklı tarama hızlarının ölçümler üzerindeki etkisi DPV yöntemi uygulanarak ölçülmüştür. Alınan ölçümler neticesinde elde edilen akım değerleri Çizelge 1 'de verilmiştir. Ayrıca elde edilen voltammogramlar Şekil 1 'de toplu olarak verilmiştir.

#### İstatistiksel Analizler

Deneyel çalışma faktörleri olan Scan Speed ( $\text{X}_1$ : mV/sec) ve Concentration ( $\text{X}_2$ : µL) nun optimizasyonunda deney tasarım modeli olarak CCD (Centrale Composite Design) seçilmiş olup Response (Cevap) olarak Current ( $\text{Y}$ : µA) ölçülmüştür. Burada deney sayısı **Experiment Number**= $2^k+2k+(\text{Repetition})=1=2^2+2*2+(5)=13$  adet olarak bu model ( $\alpha=\pm 1.2671$ ) için hesaplanmıştır. Faktörlerin çalışma aralıkları daha önceki deneyimler çerçevesinde **Scan Speed** için 50/250 ve **Concentration** için 1/10 olarak belirlenmiş olup deneysel faktörlere bağlı olarak ölçülen Akım (Current) değerleri Çizelge 1 'de verilmiştir. Tüm hesaplamalar ve değerlendirmeler Design-Expert 7 programında gerçekleştirilmiştir.

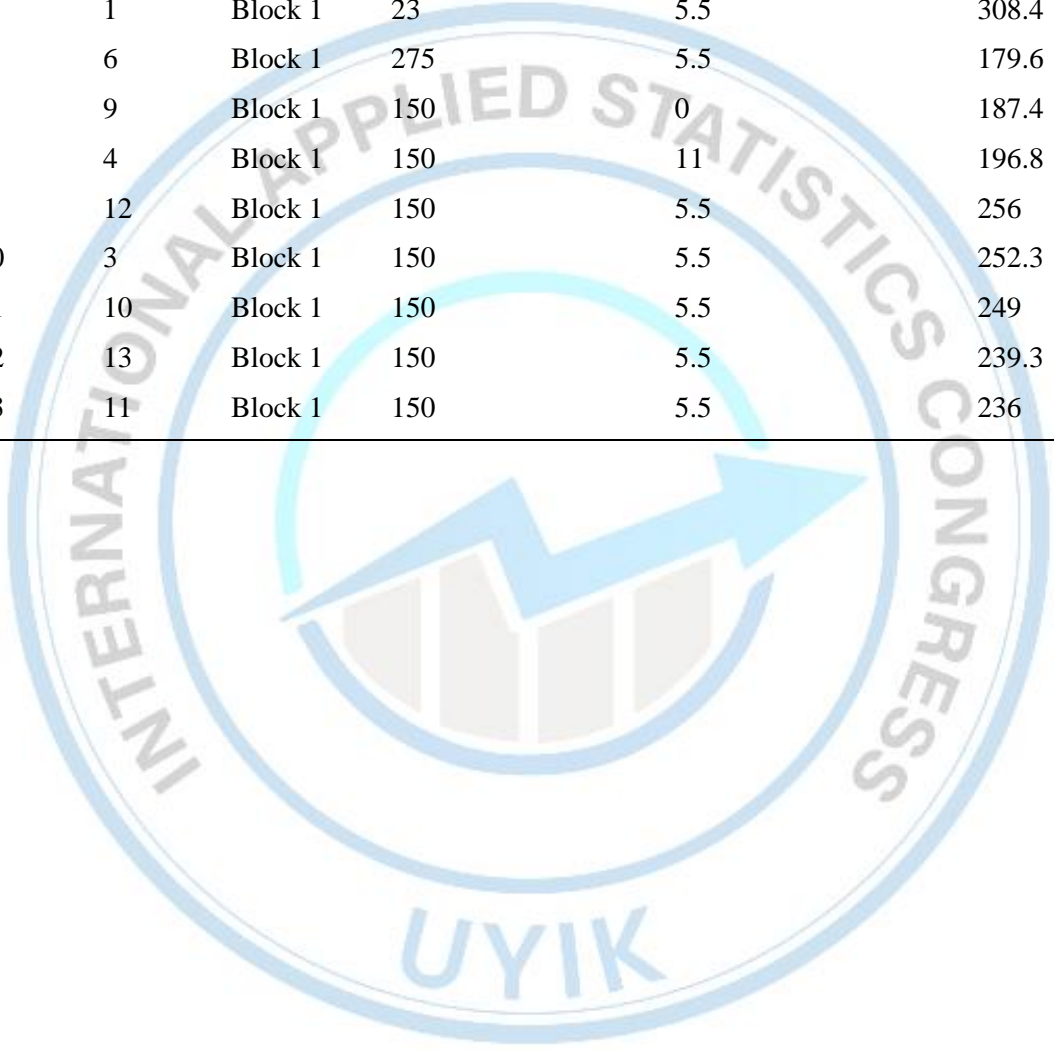
## SONUÇLAR

Aşağıda elektrokimyasal ölçümler sonunda elde edilen DPV voltammogramları iki kısımda sunulmuştur. Şekil 1.'de, Çizelge 1.'de bulunan standartlara ait ölçüm değerleri uygulanarak elde edilen voltammogramlar karşılaştırılmıştır. Ölçümler C540 modifiye ve C540 içermeyen GCPE elektrotlar kullanılarak üçlü elektrot sistemi kullanılarak alınmıştır.

V. INTERNATIONAL APPLIED STATISTICS CONGRESS (UYIK - 2024)  
İstanbul / Türkiye, May 21-23, 2024

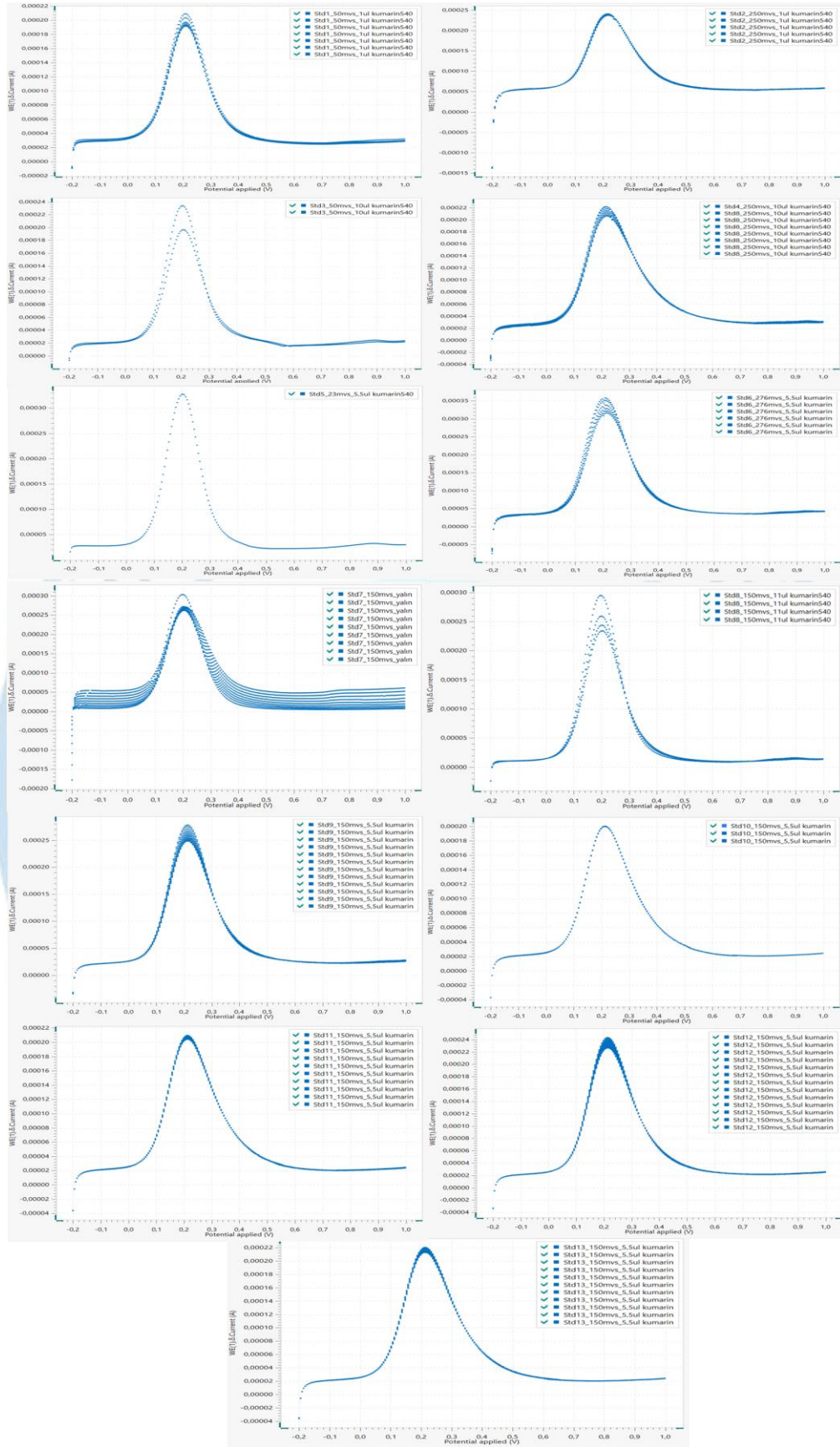
Çizelge 1. Deneyde kullanılan değişkenler ve standart değerleri

Std	Run	Block	Factor 1	Factor 2	Response 1
			A:Scan Speed	B:Concentration	Current
			mV/sec	µL	µA
1	7	Block 1	50	1	172.9
2	5	Block 1	250	1	185.6
3	2	Block 1	50	10	200.4
4	8	Block 1	250	10	188.2
5	1	Block 1	23	5.5	308.4
6	6	Block 1	275	5.5	179.6
7	9	Block 1	150	0	187.4
8	4	Block 1	150	11	196.8
9	12	Block 1	150	5.5	256
10	3	Block 1	150	5.5	252.3
11	10	Block 1	150	5.5	249
12	13	Block 1	150	5.5	239.3
13	11	Block 1	150	5.5	236





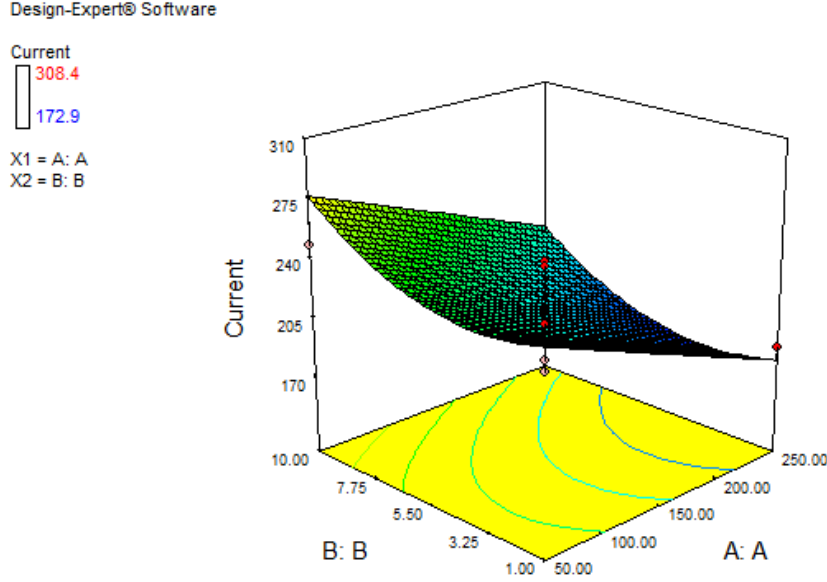
V. INTERNATIONAL APPLIED STATISTICS CONGRESS (UYIK - 2024)  
İstanbul / Türkiye, May 21-23, 2024



Şekil 1. Standart 1 ila 13 için yapılan ölçümler sonucunda elde edilen DPV voltammogramları.

Çizelge 2. Cevap yüzey fonksiyonunun çözüm katsayıları

$b_0$	$b_1$	$b_2$	$b_{12}$	$b_{11}$	$b_{22}$
+261.74657	-0.30790	-7.11808	+3.88889*10 <sup>-004</sup>	+2.42005*10 <sup>-005</sup>	+1.01908



Şekil 2. Analiz sonuç diyagramı

#### TARTIŞMA VE SONUÇ:

Deneyel çalışma faktörleri olan Scan Speed ( $X_1$ : mV/sec) ve Concentration ( $X_2$ :  $\mu\text{g/L}$ ) nun optimizasyonunda deney tasarım modeli olarak CCD (Centrale Composite Design) seçilmiş olup Response (Cevap) olarak Current ( $Y$ :  $\mu\text{A}$ ) ölçülmüştür. Burada deney sayısı **Experiment Number**= $2^k+2k+(\text{Repetition})=1=2^2+2*2+(5)=13$  adet olarak bu model ( $\alpha=\pm 1.2671$ ) için hesaplanmıştır. Faktörlerin çalışma aralıkları daha önceki deneyimler çerçevesinde **Scan Speed** için 50/250 ve **Concentration** için 1/10 olarak belirlenmiş olup deneysel faktörlere bağlı olarak ölçülen Akım (Current) değerleri Çizelge 1’de verilmiştir. Tüm hesaplamalar ve değerlendirmeler Design-Expert 7 programında gerçekleştirilmiştir. Deneyel verilerin optimizasyonuna ilişkin önerilen cevap yüzey fonksiyonu (Kvadratik Model):

$$Y=b_0+b_1X_1+b_2X_2+b_{12}*X_1*X_2+b_{11}*X_1^2+b_{22}*X_2^2$$

şeklinde olup, burada  $R^2$  (Eğri Yüzeyin Deneyel Noktalara Uyumu) en az 0,90 dır ve Cevap Yüzey Fonksiyonunun Çözüm Katsayıları Çizelge 2’de sunulmuştur. Çözümleme için en küçük kareler metodu kullanılmıştır.

Şekil 2. ve Çizelge 2’den de anlaşılacağı gibi en yüksek değerinde (308  $\mu\text{A}$ ) Scan Speed ( $X_1$ : mV/sec) ve Concentration ( $X_2$ :  $\mu\text{L}$ ) faktörlerinin optimum 23 ve 5.5 olduğu anlaşılmaktadır.

Ancak burada dikkat edilmesi gereken nokta en yüksek hesaplanmış değer respons (cevap) yüzey grafiğinin bir köşesinde yer almakta olup optimum alanın dışında daha yüksek değerler alabilecektir. Bu nedennle bu duruma bağlı olarak faktörlerin alt üst çalışma aralıkları yeniden belirlenip tasarımın bu aralıklara bağlı olarak yeniden yapılması ve denemelerin tkrarlanarak yüzey alanı içinde kalacak şekilde belirlenmesinin daha güvenilir sonuçlar getirmesi sağlanmış olacaktır.

### References

- Egan, D., O'kenney, R., Moran, E., Cox, D., Prosser, E., & Thornes, R. D. (1990). The pharmacology, metabolism, analysis, and applications of coumarin and coumarin-related compounds. *Drug metabolism reviews*, 22(5), 503-529.
- Jain, P. K., & Joshi, H. (2012). Coumarin: chemical and pharmacological profile. *Journal of Applied Pharmaceutical Science*, (Issue), 236-240.
- Peng, X. M., LV Damu, G., & Zhou, H. (2013). Current developments of coumarin compounds in medicinal chemistry. *Current pharmaceutical design*, 19(21), 3884-3930.
- Boicea, V. A. (2014). Energy storage technologies: The past and the present. *Proceedings of the IEEE*, 102(11), 1777-1794.
- Mamuk, A. E., Koçak, C., Aslan, S., & Bal Altuntaş, D. (2022). Electrochemical properties of coumarin 500 encapsulated in a liquid crystal guided electrospun fiber core and their supercapacitor application. *ACS Applied Energy Materials*, 5(10), 12078-12089.

### Conflict of Interest

"The authors have declared that there is no conflict of interest".





## Customized Survival Strategies: A Case Study of Firm Resilience in Albania

**Lule Basha<sup>1\*</sup>, Eralda Gjika<sup>2</sup>, Klejda Hallaçi<sup>3</sup>**

<sup>1</sup>Department of Applied Mathematics, Faculty of Natural Science, University of Tirana, Tirana, Albania

<sup>2</sup>Royal College of Physician and Surgeons of Canada, Ottawa, Canada

<sup>3</sup>Department of Scientific Research, The Faculty of Research and Development, Polis University, Tirana, Albania

\*Corresponding author e-mail: lule.hallaci@fshn.edu.al

### *Abstract*

*Firm survival is a critical aspect impacting both economies and employees, particularly in rapidly evolving business environments. This study focuses on the survival dynamics of 1560 firms in Albania over a period of from January 1992 to the last day of February 2024, examining factors that influence their longevity. The initial part of the study involved rigorous data cleaning since the process of obtaining the data was through web scraping. Kaplan-Meier method was employed to analyze the firms' survival time, with a primary emphasis on understanding their resilience. Furthermore, we investigated the legal structure and geographical location of these companies as key factors and the impact that they have on firm survival using the Cox Proportional hazard method. The results reveal significant differences in survival distributions between natural person and Limited Liability Company forms. In the subsequence part, given the prevalence of Limited Liability Companies in our sample, we specifically focused the survival dynamics of these form of firms. Our analysis, incorporating factors such as capital investment, number and nationality of partners, and operational location, underscored the critical role these elements play in firm longevity. The information provided at the end of this study highlights important factors that should be considered by stakeholders operating or intending to operate in the Albanian region. Understanding these factors can guide strategic decision-making and resource allocation, ultimately enhancing business sustainability and success.*

**Keywords:** firms; survival analysis; Kaplan-Meier; Cox Proportional Hazard model

### **INTRODUCTION**

Firm survival is the primary goal for most companies because of its impacts on the national economy, local communities, employees, and others. However, achieving long-term sustainability during the survival of firms is demanding, especially when business settings are undergoing rapid transformations (Drucker, 1954). Analyzing the entry and exit of firms from the economic market is essential for understanding the corporate structure within a country and for studying economic growth. In 1958, the average lifespan of companies featured in the Standard and Poor's 500 was 61 years, but in 2016, this figure is less than 18 years. OCDE (2014) finds that the probability that firms operating in specific markets survive for more than two years increases from 60% to 80%. Furthermore, only 40–50% of firms founded in the same year continue to exist beyond the seventh year. The scientific literature regarding the lifespan of firms and the variables that influence it is quite rich. Studies on the organization of businesses have examined the issue of their survival, paying special attention to circumstances that change over time, as well as external environmental factors (Napolitano et al., 2015). Also, previous studies have tried to examine a number of factors that influence the longevity of a firm, such as age, size, history, skills, culture, industry characteristics, etc. (Albuquerque and Hopenhayn 2004; Gallo and Christensen, 2011; Aghion et al., 2015; Okwo et al., 2019). Segarra and Castejón, 2002, emphasize the crucial role of innovation and technological advancement in ensuring the survival of Spanish manufacturing firms. Muñoz et al., 2020 compares the survival time of non-cultural firms versus cultural firms, examining how factors such as profitability, solvency and debt affect their longevity. Correa et

al., 2003 and Mateut et al., 2006 study the impact that the solvency of these firms has on their longevity, this within the context of Spanish firms. Delmar et al., 2013 identified profitability as the main factor of survival and growth among Swedish firms. Guimaraes 2016 studies the effects of debt on small enterprises in Brazil.

In order to study the survival time of firms and the factors that influence this lifespan, the use of survival analysis methods remains the main and most important methods. Through the use of survival analysis methods (Musso and Schiavo, 2008; Bandick 2010; Okubo and Strobl, 2021; Clò et al., 2024), researchers can effectively examine the duration until firms exit the market, providing insights on the influence of internal and external influencing factors. Muñoz et al., 2020, in their study on the difference in survival time between non-cultural firms compared to cultural firms use the Kaplan-Meier method, the Harrington-Fleming test and the Cox regression model to check the statistical significance of the factors studied. Baumöhl and Kočenda, 2022, studied 100,000 businesses in emerging European economies, from 17 different countries, between 2006-2017, and used the Cox proportional hazards model. Pittiglio 2023, investigates the impact of counterfeiting on firm survival. For this purpose, they studied a selection of Italian manufacturing firms during the period 2008-2014, using a discrete-time risk model and survival probabilities.

In the economy of Albania, small and medium-sized enterprises are vital and have served over time as a cornerstone for national well-being. Albanian small businesses have been established since 1991, emerging gradually, initially driven by a “learning by doing” approach to entrepreneurship. In 2020, micro, small and medium enterprises dominated in Albania, with 102,405 of them and 99.8% of all businesses. The proportion of small and medium-sized enterprises remains the same, despite a 4.7 percentage point decline in their number between 2017 and 2020 (OECD, 2022). Among these ventures, less than half survive more than five years and only a handful become large companies.

The purpose of this paper is the analysis of the survival time per month for 1560 firms in Albania, over a period of from January 1992 to the last day of February 2024. The work can be considered divided into two separate sections. First through the use of the Kaplan-Meier method, we have analyzed the survival time of these firms. We have also studied the legal form and the place where these companies operate. Through the Cox Proportional hazard method, we studied how these two factors affect the survival time of a firm. Also if there is any statistically significant difference between the legal form of the firms at the time of survival or the country at the time of survival. Second, after we have evaluated the impact that the legal form has on the survival time, since each form carries different rights and responsibilities and especially different upper limits of losses, the papers estimated the effects of two legal forms - natural person (NP) and limited liability company (LLC). Since the legal type limited liability company (LLC) is the largest percentage of the companies studied, then we have included this type in the study. We have analyzed the survival time for this type of firms, taking into account the influence of factors such as: capital; number of partners; whether the partners are Albanian or foreign; and the place where they operate, through the Cox Proportional hazard method.

The paper is organized as follows: Section 2 presents an overview of survival analysis models. Section 3 describes the characteristics of datasets and the main results of the work for all firms taken in the study and then only for legal firms of the LLC type. In session 4, the results of the work, shortcomings and the work that can be done in the future are presented.

## **MATERIAL AND METHODS**

Survival analysis is a crucial field that includes various statistical methods for analyzing data from the time of onset to the occurrence of a network event. The applicability of survival analysis spans different domains due to the broad definition of an ‘event’, which can range from mortality to graduation or bankruptcy. As a result, survival analysis finds utility in fields as diverse as medicine, sociology, marketing, and economics.

Let  $X$  represents a set of variables,  $T$  denotes the time until the event of interest occurs (which is non-negative),  $C$  represents the censoring time (also non-negative), and  $\delta$  is an indicator variable denoting whether the event has occurred or not. In this case, the target time,  $y_i$ , of the event is:

$$y_i = \begin{cases} T_i, & \text{if } \delta_i = 1 \\ C_i, & \text{if } \delta_i = 0 \end{cases} \quad (1)$$

Therefore, the analysis task is focused to examining triplets  $(X_i, y_i, \delta_i)$  for each observation  $i$ , where  $y_i$  and  $\delta_i$  are the target variables. Using variable  $X_j$ , the objective is to forecast the actual event time,  $T_j$ , which is hidden for censored observations.

Two separate and mutually exclusive probabilities of survival and hazard are commonly used to characterize and model survival data. these two approaches have been particularly important in the development of the field of survival analysis. First, an estimator for survival probability was introduced by Kaplan and Meier (Kaplan and Meier, 1958). The second comes from Cox, who developed the regression model now known as the Cox Proportional Hazard Model (Cox, 1972). It is interesting to note that both of the aforementioned models are still in high demand and should be in the toolkit of every data scientist (Emmert-Streib and Dehmer, 2019). The Kaplan–Meier (KM) estimator of a survival function is given by

$$S_{KM}(t) = \prod_{i:t_i < t} \left(1 - \frac{d_i}{n_i}\right) \quad (2)$$

where for each time point  $t_i$ ,  $n_i$  are the number of remaining observation and  $d_i$  are the number of events. The Nelson–Aalen estimator (Aalen, 1978; Nelson 1972) is an indirect estimator for survival function as opposed to the Kaplan–Meier estimator, which is a direct estimator. Rather, the cumulative hazard function provided by the following equation is directly estimated via the Nelson-Aalen estimator:

$$S_{NA}(t) = \exp\left(-\sum_{i:t_i < t} \frac{d_i}{n_i}\right) \quad (3)$$

Nonparametric methods don't consider how observations and target variables are related in terms of their values. On the other hand, parametric methods assume a specific theoretical relationship and evaluate features' importance based on their influence on predictions. The Cox Proportional Hazards (Cox PH) model assumes that all observations share the same hazard function shape and vary only by a positive proportionality coefficient. The Cox PH is a semiparametric regression model that defines the hazard function by:

$$h(t | X_i) = h_0(t) \exp\left(\sum_i^p \beta_i X_i\right) \quad (4)$$

where  $h_0(t)$  is the baseline hazard function and  $\beta$  is the vector of linear model coefficients. Although it does not assume anything about the baseline hazard function, the Cox proportional hazards regression model is semi-parametric as it does assume a parametric form for the predictors' effect on the hazard.

The ability to estimate parameters  $\beta_i$  without first estimating the baseline hazard function is a key benefit of the Cox PH methodology.

For testing the validity of the proportional hazard assumption several graphical and statistical tests have been suggested. Graphical methods assess the PH assumption for each variable individually. The



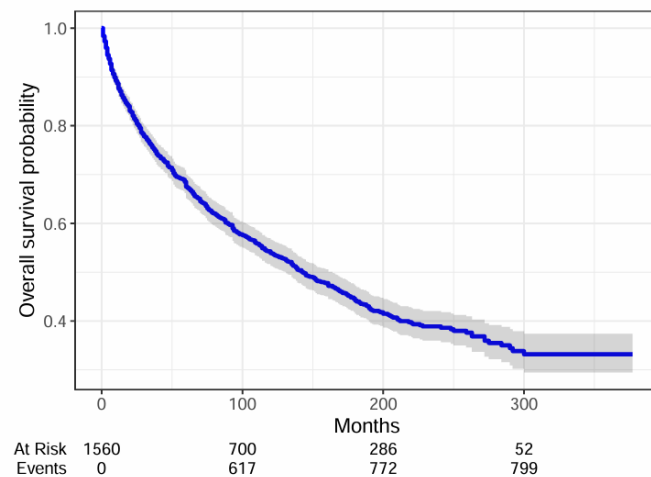
basic idea behind these methods is: Comparing estimated  $\ln(-\ln)$  survival curves; and Comparing observed survival curves with predicted ones. While the most widely used statistical test, originally suggested by (Schoenfeld, 1982), is a modified version of a test based on Schoenfeld residuals.

## RESULTS

In this study, we have analyzed the survival time for businesses in Albania and the factors that influence this time. The firms were founded in the period from the first day of January 1992 to the last day of February 2024. Initially, the historical extracts of the firms were downloaded from the National Business Center in Albania, in pdf format. Then, through an algorithm created by the authors in Python, the necessary information for processing was extracted and the data was downloaded to Excel. The information extracted is the time when the firm was founded, whether it is active or not, the type of legal firm, the capital, the place where it operates, the number of partners and the nationality of the partners. If the firm is registered, that is, it is no longer active, a “censored” variable takes the value 1. If the firm is still active, the variable takes the value zero, because these data are censored. Indeed, these firms have not reached the event of interest, which is deregistration, but they contain information about the time of their survival. With the monthly time from registration to deregistration of firms, or censoring, we have created the variable “time”, which is also the survival time for firms. We have a total dataset with 1560 firms. The work can be considered divided into two parts. In the first part of the work, the entire database was studied, and in the second part, only the forms whose legal form is the LLC were studied.

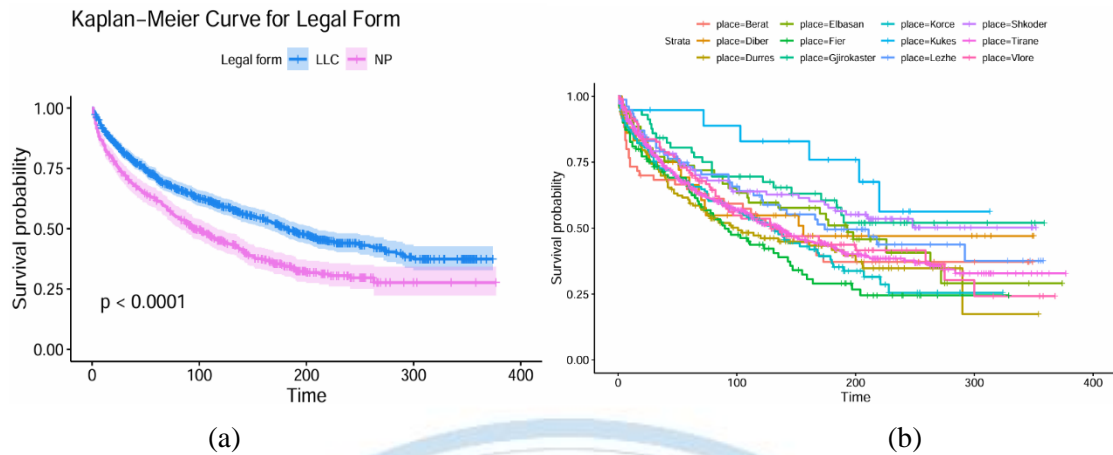
### 3.1. Comparative Analysis of Natural Person and Limited Liability Companies

In the first step, survival time was studied using the Kaplan-Meier method, cumulative hazard function using the Nelson-Aalen method, and the influence of factors such as legal form and country on this time using the Cox Proportional Hazard Model. From the data, 51% of the firms were registered until the end of the study period, that is, on the last day of February 2024, and 49% of the data are censored.



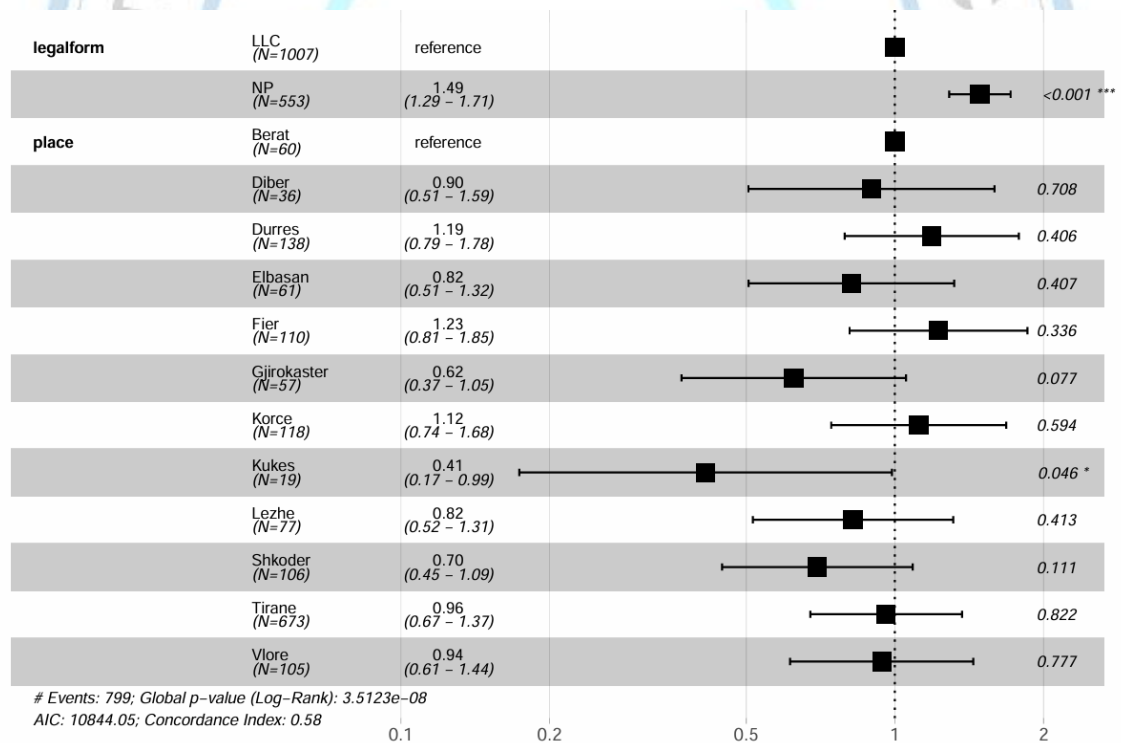
**Figure 1.** Kaplan-Meier estimator for firm survival

According to the Kaplan-Meier estimator, approximately 50% of the firms in the sample interrupt their activity, that is, they are deregistered within 143 months, Figure 1. The standard error associated with this estimate is relatively small (0.0139), indicating a relatively accurate estimate. While 25% of the firms are closed within 38 months from the start of their activity.



**Figure 2.** Kaplan-Meier estimator with respect to different levels (a) legal form; (b) place

The largest percentage of firms, 65%, belong to the legal form LLC and the rest are of the legal form NP. Among the group of unregistered firms, 57% of them are LLC type and 43% are NP. Figure 2 (a) gives Kaplan-Meier survival curve with respect to different levels of the legal form variable. This is a common approach to analyze how different categories of legal forms of firms' influence survival probabilities over time. The results of the log-rank test show that there are statistically significant differences in the survival distributions between the two types of legal forms, LLC and NP, with a *p.value* lower than 0.05. Therefore, we conclude that there is a significant difference in survival between firms with different legal forms.

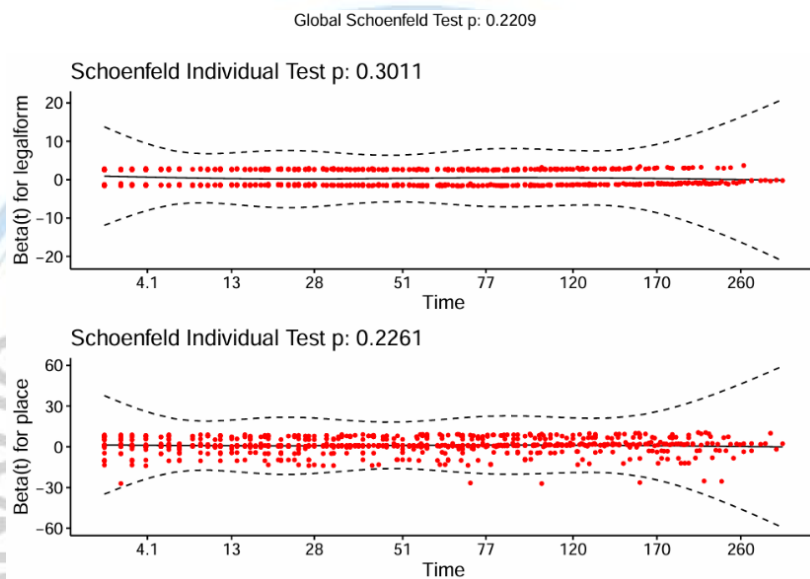


**Figure 3.** The coefficients and their confidence intervals from the Cox proportional hazards model

Firms operating under the legal form of Limited Liability Company (LLC) exhibited a median survival time of 181 months, while the legal form of Natural Person (NP) have a shorter median survival time of 96 months. Figure 2 (b) gives Kaplan-Meier survival curve with respect to different levels of place when a firm operate. The results indicate that there are statistically significant differences in survival distributions between at least some of the levels of the place variable, with a *p.value* of 0.003.

The Cox proportional hazards model has been fitted to the data, taking into consideration the legal form and place factors, to study the impact they have on survival time. From the results of the model, Figure 3, we can say that the legal form significantly impacts the hazard rate. Firms classified as NP have a hazard ratio of 1.486, indicating that they have a 48.6% higher hazard to close compared to firms classified as LLC.

We cannot say the same thing about the place variable, because the results show that there is no significant difference in hazard rates between these places and the reference location. The likelihood ratio test with a  $p$ -value of  $4e-08$  indicates that the full model significantly improves the fit compared to the null model. While the Score (logrank) test indicates that the model as a whole is statistically significant.



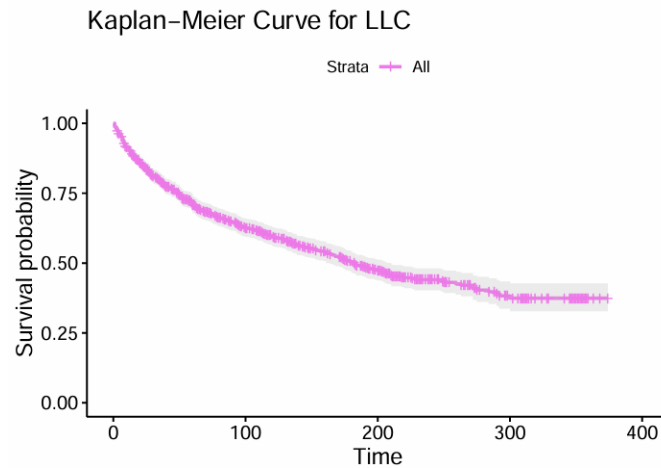
**Figure 4.** Schoenfeld residuals for the proportional hazards assumption

Also, we have conducted a test to determine whether the proportional hazards assumption holds for each predictor in the Cox proportional hazards model, Figure 4. For the legal form, the test statistic is 1.07 with a  $p$ -value of 0.30, suggesting that the proportional hazards assumption holds for this variable. Also, the results suggest that the proportional hazards assumption holds for the place variable as well. The overall test of the proportional hazards assumption across all predictors yields a test statistic of 15.39 with a  $p$ -value of 0.22. These results indicate that the proportional hazards assumption is reasonable for both factors taken into consideration as well as for the entire model.

### 3.2. Focused Analysis on Limited Liability Companies

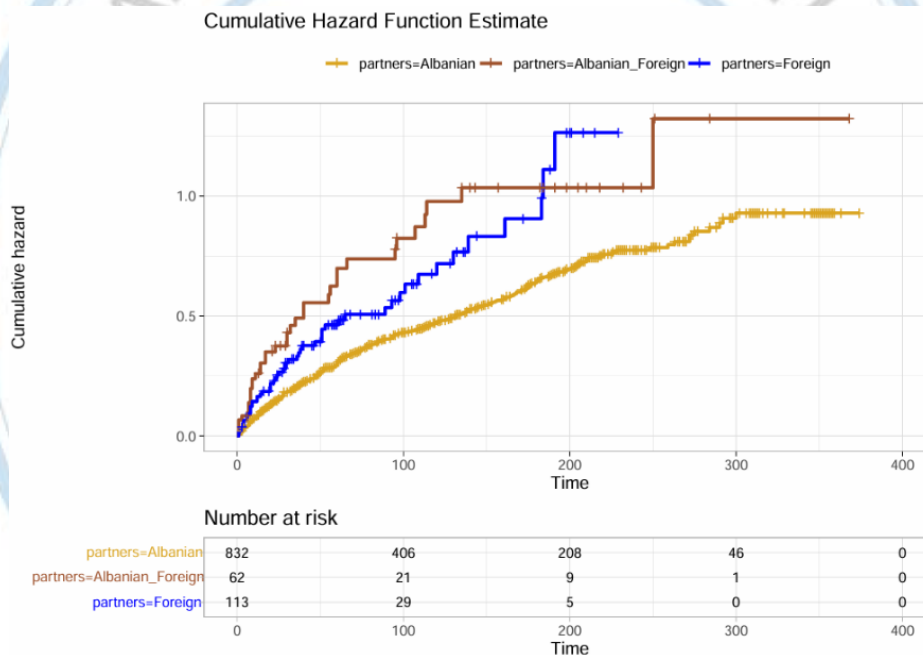
In the second part of our paper, we have studied only the firms whose legal form is Limited liability companies (LLC), in total there are 1007 such firms. Until the last day of February 2024, 45% of them have been deregistered from their activity and the rest are still active. The estimated median survival time for these firms is 181 months, with a 95% confidence interval ranging from 164 to months. While 25% of the firms are closed within 38 months from the start of their activity.





**Figure 5.** Kaplan-Meier estimator for Limited Liability Companies survival

In addition to the survival time for these firms, we also have studied the impact that factors such as capital, the place where they operate, the number of partners and the citizenship of the partners, have on the survival time.



**Figure 6.** Cumulative Hazard Function Estimate for partners

We have classified the variable which studies the citizenship of the partners into three categories: Albanian; Foreign; Albanians and foreigners. The results from the log-rank test indicate that there are statistically significant differences in survival distributions between the levels of this variable, with a *p.value* of 8e-05. Companies that have only Albanian partners have a greater chance of survival compared to the other two groups. Firms whose partners are both Albanian and foreign have the lowest survival rates, Figure 6. Also for the place variable, the results indicate that there are statistically significant differences in survival distributions between at least some of the levels of the place variable.

The Cox proportional hazards model fitted to the firm survival data in Albania provides valuable insights into the impact of various factors on firm longevity, Table 1. The coefficient for capital is statistically significant ( $p = 0.000141$ ), indicating that capital investment has a significant impact on firm survival.

Table 1. Cox Proportional Hazard model

	coef	exp(coef)	se(coef)	z	Pr(> z )
capital	-0.0094	0.9906	0.0048	-3.806	0.0001 ***
no_partners	-0.0091	0.9909	0.0613	-0.150	0.8811
partnersAlbanian_Foreign	0.4542	1.5750	0.1947	2.333	0.0196 *
partnersForeign	0.2716	1.3120	0.1516	1.791	0.0733
placeDiber	-0.5984	0.5497	0.4126	-1.450	0.1469
placeDurres	-0.0437	0.9572	0.2.865	-0.153	0.8786
placeElbasan	-0.6295	0.5328	0.3882	-1.622	0.1048
placeFier	-0.0360	0.9646	0.3209	-0.112	0.9105
placeGjirokaster	-0.3415	0.7107	0.3432	-0.995	0.3197
placeKorce	0.0731	1.0760	0.2926	0.250	0.8025
placeKukes	-0.6860	0.5036	0.5660	-1.232	0.2177
placeLezhe	-0.3651	0.6941	0.3200	-1.141	0.2539
placeShkoder	-0.5077	0.6019	0.3101	-1.637	0.1015
placeTirane	0.1118	1.1180	0.2545	0.439	0.6603
placeVlore	-0.0885	0.9153	0.2979	-0.297	0.7662

Signif. codes: 0 '\*\*\*' 0.001 '\*\*' 0.01 '\*' 0.05 '.' 0.1 ' ' 1  
 Likelihood ratio test= 72.46 on 15 df, p=2e-09  
 Wald test = 37.08 on 15 df, p=0.001  
 Score (logrank) test = 54.96 on 15 df, p=2e-06

Specifically, for each unit increase in capital, the risk of closure decreases by a factor of 0.99. Firms with Albanian and foreign partners exhibit a significant increase in the hazard of closure ( $p = 0.019651$ ). This suggests that firms with a combination of Albanian and foreign partners are 1.575 times at higher risk of closure compared to firms with solely Albanian partners. Similarly, firms with foreign partners also show a significant increase in the hazard of closure ( $p = 0.073338$ ), with a value of 1.312, compared to firms with solely Albanian partners. None of the individual locations (Berat, Diber, Durres, etc.) show statistically significant coefficients, indicating that location alone does not have a significant impact on firm survival in this model. The same can be said for the number of Partners.

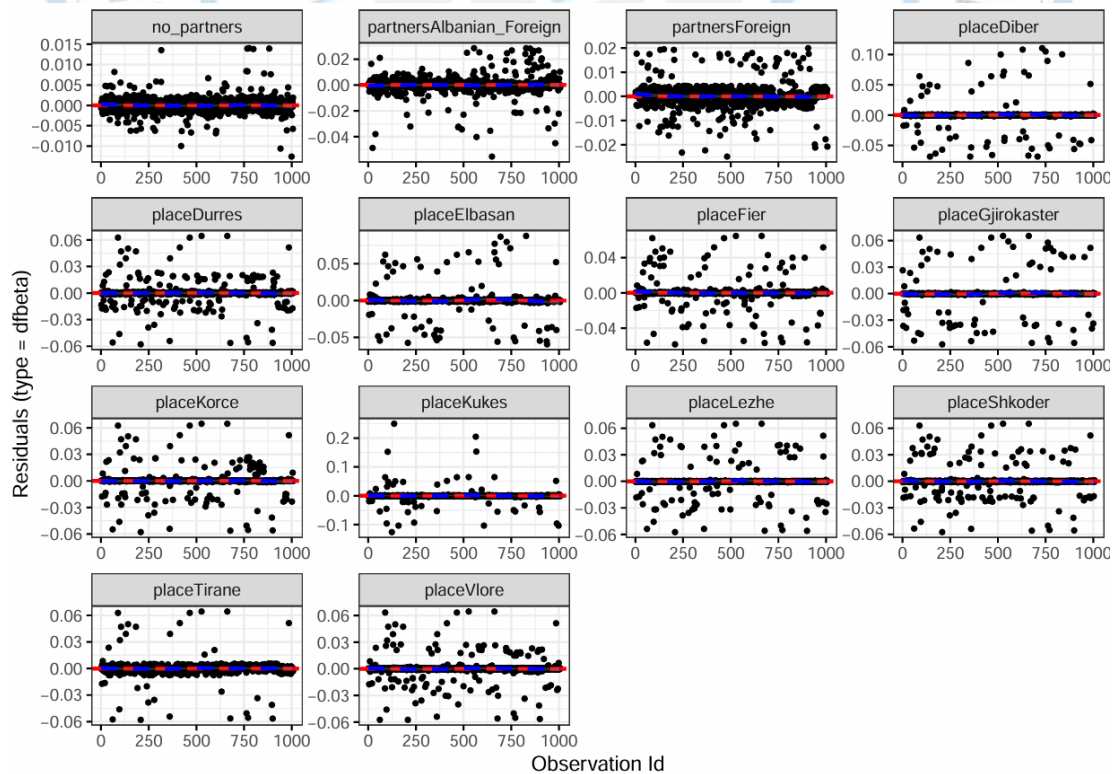


Figure 7. Diagnostic Plot for Cox Proportional Hazards Model

Figure 7 visualizes diagnostic measures for Cox proportional hazards models and shows the influence of each observation on the regression coefficients. The horizontal line represents the threshold for influential observations. Observations beyond this line are considered influential. Larger vertical distances imply greater influence. In this part too, we have studied whether the conditions of the Cox Proportional Hazard model hold. The results show that each of the variables fulfills the conditions, those of proportional hazard and the model in total as well. For this we have used Schoenfeld residuals. The overall test for the proportional hazards assumption across all variables has a *p.value* of 0.311. Since the *p.value* is greater than the significance level, we suggest that the overall model satisfies the proportional hazards assumption.

## DISCUSSION AND CONCLUSION

The study illuminates the landscape of firm survival in the business sector in Albania, emphasizing the determinant factors of longevity in a developing economic environment. Through rigorous analysis using survival analysis methodologies, significance revelation have surfaced in terms of the influence of legal form, operational location, capital investment, and partner composition on firm survival longevity. The findings underline the importance of the legal form in determining the survival of the firm, with a *p.value* of the log-rank test lower than 0.05. have a higher level of resilience and a better likelihood of survival when compared to natural persons. The Cox Proportional Hazard method suggests that the legal form of a company can significantly impact its ability to withstand challenges and continue operating successfully over time in economies as Albania.

Additionally, the study reveals the key role of capital investment in mitigating the risk of closure, highlighting the importance of financial resources to sustain business operations over time. Specifically, for each unit increase in capital, the risk of closure decreases by a factor of 0.99. Companies with exclusively Albanian partners exhibit a higher likelihood of survival when compared to the other two groups, indicating that partner composition plays a significant role in determining firm longevity. Firms with a combination of Albanian and foreign partners are 1,575 times at higher risk of closure compared to firms with solely Albanian partners, while, firms with foreign partners are 1,312 times at risk of closure. Moreover, although operational location appears to have a limited direct impact on firm survival, it underscores the importance of implementing localized strategies that are customized to the unique economic conditions of different regions within Albania. The findings of this study highlight important factors that should be considered by stakeholders operating or intending to operate in the Albanian region. Understanding these factors can guide strategic decision-making and resource allocation, ultimately enhancing business sustainability and success.

## References

- Aalen O., 1978. Nonparametric inference for a family of counting processes. *Ann. Stat.*, 6, 701–726. DOI: 10.1214/aos/1176344247
- Aghion P., Akcigit U., Howitt P., 2015. The Schumpeterian Growth Paradigm. *Annu. Rev. Econom.* 7, 557–575. <https://doi.org/10.1146/annurev-economics-080614-115412>
- Albuquerque R., Hopenhayn H. A., 2004. Optimal Lending Contracts and Firm Dynamics, *The Review of Economic Studies*, Volume 71, Issue 2, Pages 285–315, <https://doi.org/10.1111/0034-6527.00285>
- Bandick R., 2010. Multinationals and plant survival. *Rev World Econ* 146, 609–634. <https://doi.org/10.1007/s10290-010-0068-4>
- Baumöhl E., Kočenda E., 2022. How Firms Survive in European Emerging Markets: A Survey, *Eastern European Economics*, 60:5, 393-417, <https://doi.org/10.1080/00128775.2022.2099422>
- Clò S., David F., Segoni S., 2024. The impact of hydrogeological events on firms: Evidence from Italy. *Journal of Environmental Economics and Management*, 124(102942), 102942. <https://doi.org/10.1016/j.jeem.2024.102942>
- Correa A., Acosta M., González A.L., 2003. La insolvencia empresarial: Un análisis empírico para la



- pequeña y mediana empresa. *Rev. Contab.-Span. Account. Rev.* 2003, 12, 47–49.
- Cox D.R., 1972. Regression models and life-tables. *J. R. Stat. Soc. Ser. B (Methodol.)*, 34, 187–202. <https://doi.org/10.1111/j.2517-6161.1972.tb00899.x>
- Delmar F., McKelvie A., Wennberg K., 2013. Untangling the relationships among growth, profitability and survival in new firms. *Technovation* 33, 276–291. <https://doi.org/10.1016/j.technovation.2013.02.003>
- Drucker P.F., 1954. *The Practice of Management*; Harper & Row: New York, NY, USA, 1954.
- Emmert-Streib F., Dehmer M., 2019. Defining data science by a data-driven quantification of the community. *Mach. Learn. Knowl. Extr.* 1, 235–251. <https://doi.org/10.3390/make1010015>
- Gallo P. J., Christensen L. J., 2011. Firm Size Matters: An Empirical Investigation of Organizational Size and Ownership on Sustainability-Related Behaviors. *Business & Society*, 50(2), 315–349. <https://doi.org/10.1177/0007650311398784>
- Guimaraes B. E., 2016. Determinants of Small Business Survival: The Case of Very Small Enterprises of the Traditional Manufacturing Sectors in Brazil. <https://ssrn.com/abstract=2802706>
- Kaplan E.L., Meier P., 1958. Nonparametric estimation from incomplete observations. *J. Am. Stat. Assoc.*, 53, 457–481. DOI: 10.1080/01621459.1958.10501452
- Mateut S., Bougheas S., Mizen P., 2006. Trade credit, bank lending and monetary policy transmission. *Eur. Econ. Rev.* 50, 603–629. <https://doi.org/10.1016/j.euroecorev.2005.01.002>
- Muñoz Dueñas M.P., Vaamonde L.A., Cabrita M.R., 2020. The Survival of Cultural Firms: A Study of Multiple Accounting Parameters in Spain. *Sustainability*. 12(3):1159. <https://doi.org/10.3390/su12031159>
- Musso P., Schiavo S., 2008. The impact of financial constraints on firm survival and growth. *J Evol Econ* 18, 135–149 (2008). <https://doi.org/10.1007/s00191-007-0087-z>
- Napolitano M.R., Marino V., Ojala J., 2015. In search of an integrated framework of business longevity, *Business History*, 57:7, 955–969, <https://doi.org/10.1080/00076791.2014.993613>
- Nelson W., 1972. Theory and applications of hazard plotting for censored failure data. *Technometrics*, 14, 945–966. DOI: 10.1080/00401706.1972.10488991
- OECD, 2014, <https://www.oecd.org/mcm/C-MIN%282014%2914-ENG.pdf>
- OECD, 2022, <https://www.oecd-ilibrary.org/sites/d22fdb37-en/index.html?itemId=/content/component/d22fdb37-en>
- Okubo T., Strobl E., 2021. Natural disasters, firm survival, and growth: evidence from the Ise Bay typhoon, Japan. *J. Reg. Sci.* <https://doi.org/10.1111/jors.12523>
- Okwo H., Ezenwakwelu C., Igwe A., Imhanrenialena B., 2019. Firm Size and Age mediating the Firm Survival-Hedging Effect: Hayes’ 3-Way Parallel Approach. *Sustainability* 2019, 11, 887. <https://doi.org/10.3390/su11030887>
- Pittiglio R., 2023. Counterfeiting and firm survival. Do international trade activities matter? *International Business Review (Oxford, England)*, 32(5), 102145. doi:10.1016/j.ibusrev.2023.102145
- Schoenfeld D., 1982. Partial residuals for the proportional hazards regression model. *Biometrika*, 69, 239–241. <https://doi.org/10.1093/biomet/69.1.239>
- Segarra A., Callejón M., 2002. New Firms’ Survival and Market Turbulence: New Evidence from Spain. *Rev. Ind. Organ.* 20, 1–14. <https://doi.org/10.1023/A:1013309928700>

## The Impact of Ib Physical and Health Education Curriculum on Students' Physical Literacy and Social Skills Development for a Healthy Lifestyle

Oluwaseyi Olubunmi Sodiya<sup>1\*</sup>, Turkan Nabiyeva<sup>2\*</sup>

<sup>1</sup>Doctor of Philosophy in Organisation and Planning of Education Faculty of Natural Science, Arts and Technology of Higher Education, Khazar University Baku, Azerbaijan

<sup>2</sup>MYP Coordinator Khazar University Dunya School, Baku, Azerbaijan

\*Corresponding Author e-mail: oluwaseyi.sodiya@khazar.org, t.nabiyeva@dunyaschool.az

### Abstract

*The distinction between regular physical education and international baccalaureate physical and health education is significant. The IB Physical and Health Education curriculum promotes the holistic development of students, encompassing their mental and emotional well-being, physical fitness, and social skills. The IB curriculum focuses on the promotion of a healthy lifestyle, the cultivation of lifelong habits, and the development of physical literacy. The department of physical and health encountered a number of challenges as it transitioned to the International Baccalaureate (IB) physical and health education curriculum. Examples include student participation, grasp of the subject's criteria, teachers' comprehension, and the development of unit topics. The purpose of this study is to investigate the influence that the International Baccalaureate (IB) curriculum has on the development of students' physical literacy and social skills in order to promote a healthy lifestyle. The research participants (students, n = 391) who are enrolled in the middle-year programme (MYP 1-4). An exploratory sequential mixed-methods research methodology was utilised for the data collection. We collected data using a variety of methods, such as questionnaires, focus group interviews, student performance tracking systems, and observation. In order to arrive at the results of the study, descriptive and inferential statistical analysis were utilised for analysing the data. The findings indicated that, following the initial year of the transition, students exhibited a heightened comprehension of their personal physical fitness and well-being. There was a notable increase in student engagement, and students were also able to use the service as action of their unit to implement action projects aimed at promoting physical activity within the school community. Increased physical fitness, increased self-assurance, and a better grasp of the importance of maintaining a healthy lifestyle are all components of students' development observed over the academic years 2022–2023. In conclusion, this research suggests that the IB MYP physical and health education curriculum provides a holistic approach to physical education. That goes beyond simple physical activity. It promotes comprehensive development and lifetime health.*

**Keywords:** Healthy-Lifestyle, Physical-Literacy, Physical-Activity, Physical-Education, IB-Curriculum, Well-being

### INTRODUCTION

The International Baccalaureate (IB) Physical and Health Education curriculum aims to enhance students' physical literacy by engaging them in a diverse range of activities and sports. likewise, it underscores the significance of cultivating social skills to foster cooperation, effective communication, and collective effort in order to adopt a comprehensive approach towards a wholesome way of life. According to Dever,(2019) the International Baccalaureate represents a continuum that encompasses four distinct programmes that not only fulfil the overarching objectives of the IB but also cater to the specific and individual requirements of the students at each level. Studies have indicated that students who participate in the International Baccalaureate (IB) Physical and Health Education programme exhibit superior levels of physical literacy and social skills in comparison to their classmates. The IB Physical and Health Education curriculum provides chances for students to contemplate their learning and establish personal fitness objectives, promoting a feeling of accountability for their own well-being.



It empowers students by fostering their sense of responsibility for their overall wellness and physical development, enabling them to make advantageous decisions that can significantly impact their life in the long term. Skrzypiec et al.,(2014) study as indicated in the finding that IB MYP schools are actively working towards developing empathy, a global self-concept, peer relationships, school relationships, self-reflection, adaptability, and confidence in IB MYP students. Only a small percentage of IB MYP students demonstrated a low degree of well-being. The comprehensive nature of the IB Physical and Health Education course not only ensures that students are well-prepared for physical activities and sports, but also provides them with essential life skills that will be advantageous in many areas of their lives. The third key component of the IB MYP programme, known as Creativity, Action, and Service (CAS), centres around arts, innovative thinking, physical activity, and community service. This programme fosters students' curiosity to investigate their passions, cultivate aptitudes, and make constructive contributions to their communities, equipping them for triumph in both scholastic and personal endeavours (Saxton & Hill, 2014,p.46). Physical literacy include proficiency and self-assurance in a range of physical pursuits, whereas social skills encompass the ability to communicate effectively, cooperate with others, and demonstrate empathy. Both factors are essential for achieving optimal physical and mental health as well as achieving one's goals and accomplishments. As individuals cultivate their physical literacy, they concurrently improve their social aptitude by engaging in collaboration, effective communication, and cooperative behaviour. Engaging in team sports cultivates leadership skills, promotes collaboration, and enhances dispute resolution abilities. The integration of physical literacy and social skills nurtures individuals who possess a comprehensive set of abilities and are adept at excelling in all facets of life. For instance, students could be instructed to monitor their daily physical activity and eating decisions, and then contemplate on the influence of these decisions on their overall well-being. This process facilitates the promotion of a more profound comprehension of the link between students' lifestyle choices and their physical well-being, so helping them to make more judicious decisions in the future. However, a student who engages in the curriculum but fails to see any enhancement in his or her physical well-being despite adhering to all the rules and monitoring their exercise and diet. This may result in emotions of disappointment and disillusionment, which might possibly deter people from persisting in their efforts to prioritise their health and well-being. The proficiency of certified IB physical and health education instructors is crucial in assisting students in surmounting challenges and modifying their objectives in a pragmatic and attainable manner. The IB physical and health education teacher (IBPHET) should be able to provide individualised instruction and encouragement, to help students overcome obstacles and maintain their drive to achieve their health and fitness objectives. The teacher should apply their experience to help students to acquire the ability to modify their approaches and concentrate on the advancements towards achieving their goals, rather of becoming dejected by temporary obstacles. This is one of the reasons IB school laid more emphasis on having a certified IBPHET to assist students in developing resilience and a growth mentality, which will have long-lasting advantages even after their involvement in the physical and health education lessons. In this current study, we identify several issues at the department of physical and health before and during transition to the International Baccalaureate curriculum, some of the problem such as low student engagement, limited understanding of subjects due to lack of unit's clarity, teachers' skills, and the formulation of unit themes. Students frequently have difficulties with motivation, self-confidence, and establishing achievable goals. Pakhalchuk & Holyuk,(2018) it is essential for teachers to equip students with the essential skills and tools needed to overcome these obstacles and sustain their enthusiasm. Teachers may have difficulties in creating health-promoting and health-enhancing educational activities during physical education sessions because they may not be fully aware of the whole environment for students and adolescents. Tackling these concerns, students may cultivate essential life skills, foster a constructive mindset, and attain triumph in physical and health education, thereby enhancing their physical and mental well-being. This study investigates the influence of the



International Baccalaureate (IB) curriculum on students' physical literacy and social skills, with the goal of fostering a healthy lifestyle and general well-being. The objective is to comprehend how educational programmes may facilitate comprehensive student development, offering significant perspectives for educators and policymakers to enhance the quality of physical and health education in schools. In this study, we explore the correlation between the cultivation of a positive mindset through physical and health education in the IB programme and its impact on students' achievements in several domains, including academics and personal growth and how it promote students' physical literacy. Regular physical activity (PA) can contribute to the development of social skills and enhance self-esteem, which is often considered a significant factor in promoting overall positive well-being (Smedegaard et al., 2016). To what degree does physical and health education in the IB curriculum promotes personal development, and physical literacy of students? Are there any differences in students' term 1 and term 2 assessment criteria scores for physical and health education?

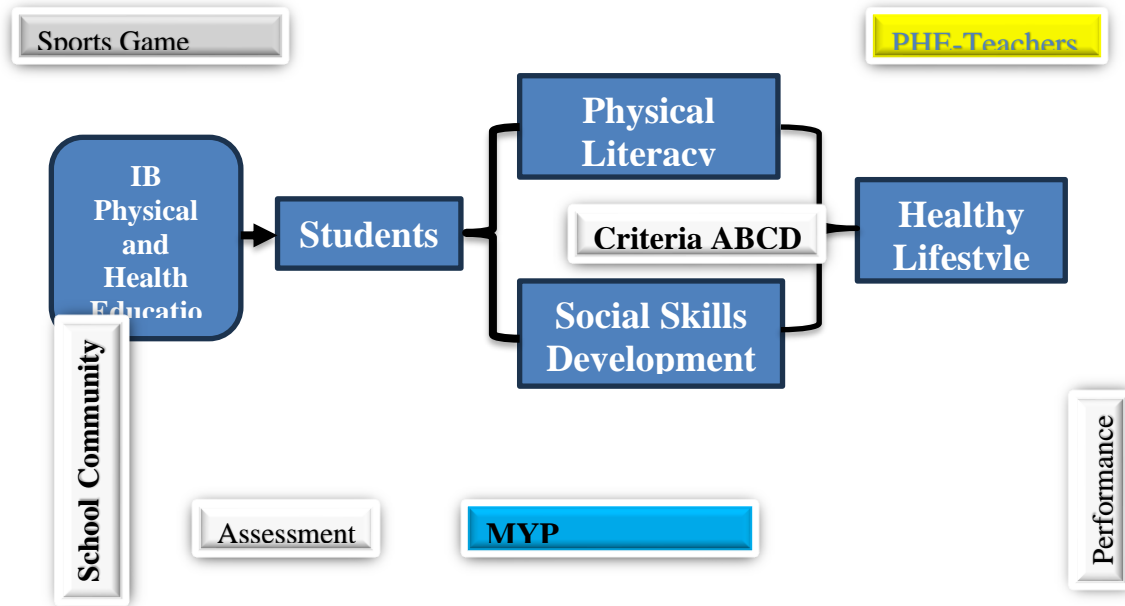
## LITERATURE REVIEW

### Theory of Change

According to Pollack,(2015) the subject of dealing with change is gaining more importance in the field of project management study and application The theory of change approach is a systematic framework that assists organisations in delineating the necessary stages to accomplish their intended objectives. The institutions may enhance their ability to monitor progress and assess effect by precisely delineating long-term goals and objectives, as well as short-term plans and actions. This technique is especially beneficial in intricate situations where several factors impact results, as it aids in identifying the primary catalysts of change and the necessary actions to achieve enduring transformation. As stated in Vogel,(2012.p.4) the theory of change approach ultimately enables organisations to be more strategic and deliberate in their endeavours to generate beneficial societal transformation. The theory of change is a continuous process of introspection aimed at understanding the nature of change and its implications for our role within a certain setting, sector, or group of individuals. A theory of change is a purposeful framework that explains how a certain commitment, such as a plan of action, policy, strategy, or project, attains its desired outcome through a sequence of initial and intermediate outcomes. Change theories facilitate the exploration of the complexity of social changes (Serrat, 2017). The incorporation of the Theory of change into the school's physical and health education curriculum is essential to ensure that students with the requisite information and abilities to make well-informed decisions regarding their health and overall well-being.

### Conceptual Framework

The Conceptual Framework displayed the theory of change on the implementation of IB physical and health education impact on the development of students' physical literacy and social skills. The objective of this framework is to offer a thorough comprehension of how International Baccalaureate (IB) physical and health education may enhance students' overall well-being. The framework emphasises the significance of combining physical education with health education to foster a comprehensive approach to student well-being. By prioritising the development of both physical literacy and social skills, students may enhance not only their physical well-being but also foster strong connections and effective communication abilities. This holistic approach guarantees that students are provided with the essential resources to effectively navigate and maintain a state of physical and mental well-being, both throughout their academic journey and in the future.



**Figure 1.** Conceptual Framework impact of Ib physical and health education curriculum on students' physical literacy and social skills development

#### The effects of physical education on physical literacy

Found in the study of Pulimeno et al.,(2020) the implementation of effective preventive measures within educational institutions should strive to increase students' inclination to internalise health knowledge and cultivate critical thinking skills among young people concerning the adverse consequences of common life-threatening behaviour. According to Harvey et al.,(2014) We hold the belief that sport education presents a potential avenue for the literacy development of young individuals. Recreational athletes and the cultivation of moral conduct can be promoted by educating and, when necessary, critiquing a specific form of ethical behaviour that has been largely established by adults. Packham & Street,( 2019) certain middle school students experience a decline in school-related motivation and engagement during adolescence, which frequently results in inadequate academic performance. A portion of this may be attributed to students' perceived lack of self-determination. Numerous students feel obligated to adhere to external regulations, concentrate on external curricula, and consistently submit to external assessment throughout their academic careers. Physical literacy has been highlighted as a crucial quality that enables students of all capacities to develop an enduring commitment to physical activity(Behzadnia et al., 2018). Students' motor abilities, coordination, and general health are all positively impacted by frequent physical exercise, according to many studies. Furthermore, exercise has been associated with enhanced cognitive function and concentration, thus it stands to reason that physical education classes can help students succeed in the classroom. In addition, studies have shown that PE can lower the odds of developing chronic conditions including diabetes, heart disease, and obesity. Incorporating physical education into the school curriculum is crucial for promoting a healthy and active lifestyle among children, as these studies demonstrate. Schools play an important role in promoting physical activity and healthy lifestyle choices among students by highlighting the benefits of regular physical activity and offering students many opportunity to engage in such activities. Not only can exercise improve physical health, but it also has a good effect on mental health by lowering anxiety and stress levels. Students' physical health, academic performance, and mental health are all improved when PE classes are a regular part of the school day. Every school curriculum must include physical education classes because of the obvious impact they have on students' health and wellbeing.

### **The relationship between physical activity and social skills**

Various studies have shown that students' proficiency in communication, collaboration, and conflict resolution improves when they engage in regular exercise. Reinders et al., (2019) Research has established a correlation between social skills and physical activity in typically developing individuals. Physical education classes provide adolescents with a priceless opportunity to enhance their psychomotor, emotional, and social growth (Primo et al., 2023) Due to the increasing importance of personal and professional relationships in contemporary society, this is now more vital than ever before. Integrating physical education (PE) into the school day enables instructors to assist children in developing a solid basis for future achievement by addressing their physical and social well-being. Also stated in Kemel et al., (2022) the majority of research has identified a correlation between physical activity and positive outcomes pertaining to physical, mental, and social wellbeing. Also supported by Eather et al.,(2023) Sports comprises a subset of physical activity that has the potential to yield significant advantages for adults' physical, mental, and social well-being, both in the short and long term. Moreover, children who engage in regular physical activity typically have enhanced mental well-being, characterised by heightened feelings of self-esteem and confidence. Physical education is a crucial component of a comprehensive education due to its benefits extending beyond only physical health. Physical education not only teaches children how to engage in physical activities such as running laps and playing sports, but also imparts important life skills such as leadership, resilience, and teamwork. In the current intricate context, where the value of collaboration and determination is high, possessing these skills is essential. On the other hand, Colombo-Dougovito & Lee,(2021) study findings establish a fundamental basis for the development of efficacious physical activity-based interventions that could potentially enhance the social competencies of people with autism . Valencia et al.,(2023) the finding supports the notion that enabling adolescents to actively participate in and benefit from leisure and recreation facilitates improved social skill management and coping, or, alternatively, serves as a containment mechanism during youth crises or social coexistence. Engaging in physical education and other physical activities is a commendable approach for schools to promote healthier lifestyles and cultivate essential skills that will have long-term advantages for children. PE is an essential component of a comprehensive education that prepares students for long-term success.

### **The impact of IB Physical and Health Education curriculum**

Studies have indicated that kids who engage in these activities not only exhibit enhanced physical fitness, but also exhibit elevated levels of academic accomplishment and general well-being. As seen in Lynch & Soukup,(2017) Physical education (PE) is characterised as "the sole curriculum subject that integrates a values-driven learning and communication with physical competence and physical development. According to (Resnik, 2012) The aspiration of the IB curriculum is to equip students with the competencies deemed essential for success in the international labour market. This may account for the high enrolment of students from middle- and upper-class households in IB schools. This integration serves as an educational gateway to cultivate the necessary skills for achieving success in the twenty-first century. The emphasis on collaboration, effective communication, and critical thinking in physical education classrooms directly contributes to achievement in academic settings and beyond. Moreover, the focus on creating objectives and maintaining determination in IB physical education curriculum enables students to cultivate the tenacity required to surmount obstacles in both their academic and personal spheres. Educators can ultimately respond actively to the two distinct education systems with regard to curriculum organisation, teaching approaches, assessment methods, and educational progression by employing innovative pedagogies through the implementation of the IBMYP(Hung & Liu, 2023). According to Ip et al.,(2017) The school environment may have an impact on childhood obesity, but previous research has frequently concentrated solely on the dietary environment. Schools



must acquire knowledge the importance of physical education and maintain comprehensive programmes that promote the overall development of their pupils. By doing this, teachers may assist in equipping kids for success in both academic and non-academic settings. According to Dickson,(2019) In addition to providing the curriculum, IB programmes facilitate in the development of a variety of skills in students by fostering an understanding of global contexts and conceptual teaching and learning .Saxton & Hill,(2014) IB students exemplify community diversity not only in their academic pursuits but also in their international travels and online interactions. They recognise the significance of diverse viewpoints in their engagement with the expanding cultural leadership, individual development, and empathy fostered by community service. In summary, the advantages of implementing a robust physical education curriculum are evident, and educational institutions should maintain their focus on this crucial component of student growth. By integrating physical education into the school curriculum, children not only enhance their physical well-being but also cultivate crucial life skills that will be beneficial to them in the long run. The knowledge acquired in physical education classes extends beyond mere physical activity and may contribute to students' success in other aspects of their lives.

## **METHODOLOGY**

The research study employed an exploratory sequential mixed-methods approach during the data collection phase. The students' summative assessment criteria (ABCD) were utilised to collect both quantitative and qualitative information on their self-ratings, experiences, and perceptions. A more comprehensive comprehension of the impact of the IB Physical and Health Education Curriculum on students' physical literacy and social skills development for a healthy lifestyle was achieved through the integration of quantitative and qualitative data. By incorporating mixed methods into a single study, one can strengthen and expand the scope of the investigation.(Creswell et al., 2006). A total of 391 middle-year programme students of (MYP 1-4) number of (Boy  $n=43$  ,Girls =37 ) total MYP 4 students ( $n=81$ ) as seen in (Table 2) MYP 4 students participants frequency. The participants were chosen for this research due to their successful completion of the two-academic year transition period for IB physical and health education.

## **Data Analysis and Findings**

Observational results suggested that in order to increase female participation in PHE classes, more compelling activities might be required. Potential activities that could be implemented comprise meditation sessions, team-building exercises, or dance classes, all of which cater to a more diverse array of interests. We can help ensure that every student has the chance to gain knowledge and develop skills that are beneficial to them through physical and health education by offering a greater variety of inclusive and diverse options. Ultimately, this will result in a more balanced and rewarding educational experience for all individuals, so it is vital to foster an atmosphere in which every student feels at ease and is encouraged to participate. See table 1 below Pre-IB Physical and Health Education Transition observation for need assessment.

**Table 1.** Pre-IB Physical and Health Education Transition observation for need assessment

Observation Checklist	Findings
<b>Teachers' teaching approach</b>	The pedagogical approach employed by teachers significantly influences students' perspectives on the development of social skills and physical literacy. Educators have the ability to cultivate favourable student outcomes and instil constructive conduct by integrating interactive and thought-provoking pedagogical approaches. According to Sympas & Digelidis,(2014)The study's results validated the beliefs held by student teachers regarding the learning process of their pupils, which were shaped by their own experience as pupils. This study emphasizes the need for ongoing professional development for teachers to effectively implement the IB physical and health education curriculum and support students in achieving their health and wellness goals.
<b>School Environment</b>	The influence of the school environment on the attitudes and behaviours of students with regard to health and wellness is significant. Motivated and engaged students are more likely to participate in physical and health education when educators place an emphasis on fostering a positive and supportive school environment. This ultimately results in improved academic achievement and general welfare of the students. The school environment was conducive; however, the teachers needs to be able to manage the space and improvise to provide the students access to quality PHE lessons. Students' intention to participate in physical and health education is associated with environment and equipment(Prins et al., 2010;Ip et al., 2017).
<b>Students' attendance</b>	The attendance of students in health and physical education classes is critical to their development and success as a whole. Teachers can assist students to comprehend the significance of adopting a healthy lifestyle and making constructive decisions by delivering lessons that are both thought-provoking and appropriate. Throughout the observation period, it was determined that there has been a decrease in student participation in Physical and Health Education (PHE) classes, with a majority of the participants being male students. Girls had much lower participation rates. The boys predominantly engaged in football, while the girls passively occupied themselves by either remaining sedentary or wandering inside the school premises.
<b>Students understanding of PHE.</b>	Students' conception of PHE is limited to playing football for the duration of the class; they will only engage in the lesson if teachers grant permission to do so. They frequently sustain injuries by simply kicking the ball around without a warm-up or following proper PHE lesson protocol. There was no implementation of the fundamental understanding of game or sport terminology prerequisite, and there was no assessment in place for tracking the students' progress.

**Table 2.** MYP 4 Students Participants Frequency

	Participants	Frequency	Percent	Valid Percent	Cumulative Percent
Valid	Male	43	53.1	53.8	53.8
	Female	37	45.7	46.3	100.0
	Total	80	98.8	100.0	
Missing	System	1	1.2		
Total		81	100.0		

The Students Physical Literacy Assessment Criteria Term 1 Criterion A ( $M = 2.00$ ,  $SD = 3.20$ ). Criterion B ( $M = 1.71$ ,  $SD = 3.05$ ), Criterion C ( $M = 5.75$ ,  $SD = 2.88$ ) and Criterion D ( $M = 1.81$ ,  $SD = 3.057$ ). The Students Physical Literacy Assessment Criteria Term 2 Criterion A ( $M = 5.33$ ,  $SD = 2.115$ ). Criterion B ( $M = 5.41$ ,  $SD = 2.254$ ), Criterion C ( $M = 6.59$ ,  $SD = 1.867$ ) and Criterion D ( $M = 5.61$ ,  $SD = 2.047$ ) as seen in *table 3* and *table 4* below.

**V. INTERNATIONAL APPLIED STATISTICS CONGRESS (UYIK - 2024)**  
**İstanbul / Türkiye, May 21-23, 2024**

**Term 1**

**Table 3.** Mean and Std. Deviation Statistics for Students Physical Literacy Assessment Criteria Term 1

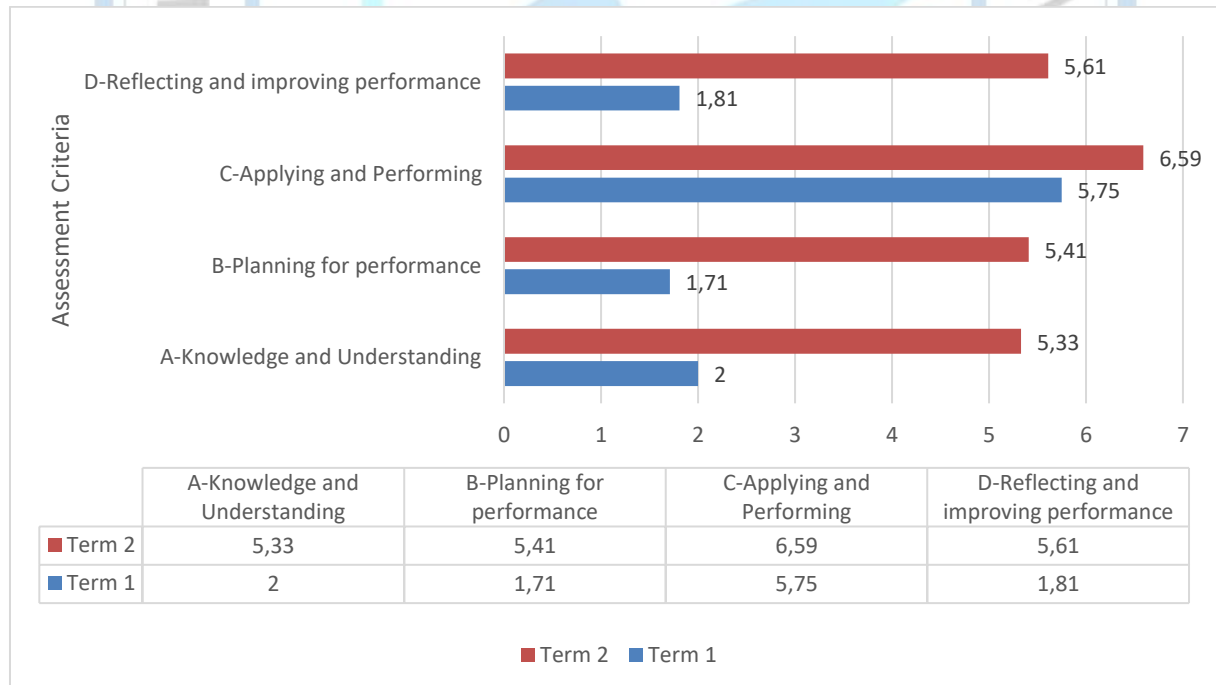
	N	Sum	Mean	Std. Deviation
<b>MYP 4 students</b>	80	116	1.45	.501
<b>Criterion A</b>	80	160	2.00	3.202
<b>Criterion B</b>	80	137	1.71	3.053
<b>Criterion C</b>	80	460	5.75	2.884
<b>Criterion D</b>	80	145	1.81	3.057
<b>Valid N (listwise)</b>	80			

**Term 2**

**Table 4.** Mean and Std.Deviation Statistics for Students Physical Literacy Assessment Criteria Term 2

		<b>MYP 4 students</b>	<b>A-Knowledge and Understanding</b>	<b>B-Planning for performance</b>	<b>C-Applying and Performing</b>	<b>D-Reflecting and improving performance</b>
N	Valid	80	80	80	80	80
	Missing	1	1	1	1	1
Mean		1.46	5.33	5.41	6.59	5.61
Std. Deviation		0.502	2.115	2.254	1.867	2.047

A mean comparison analysis was performed to assess whether there were any notable differences in the test scores of students with different criteria in terms of their physical literacy level between term 1 and term 2 in 2022/2023 academic year. The analysis revealed a statistically significant improvement in test scores from term 1 to term 2 across all criteria (ABCD) as presented below in *Figure 2* Mean Comparison 'Term 1', 'Term 2' by 'Assessment Criteria'.



**Figure 2.** Mean Comparison 'Term 1', 'Term 2' by 'Assessment Criteria'

We performed a Pearson correlation analysis on term 2 criteria ABD. The results demonstrate a strong positive connection among criterion A, B, and D, suggesting that students who demonstrate exceptional performance in one area are very likely to achieve success in other areas as well. This implies that the wide range of choices available in physical and health education have a positive impact on the holistic



growth of students. The two variables were strongly correlated,  $r = .858$ ,  $N=80$  Correlation is significant at the  $p < .01$ . all the results as shown below in *table 5* Pearson Correlation Term 2 Criterion ABD.

**Table 5.** Pearson Correlation Term 2 Criterion ABD

	Criterion B	Criterion D	Criterion A
	Pearson Correlation	1	.894**
	Sig. (2-tailed)	.000	.000
Criterion B	Sum of Squares and Cross-products	401.388	325.787
	Covariance	5.081	4.124
	N	80	80
	Pearson Correlation	.894**	1
	Sig. (2-tailed)	.000	.000
Criterion D	Sum of Squares and Cross-products	325.787	330.987
	Covariance	4.124	4.190
	N	80	80
	Pearson Correlation	.858**	.825**
	Sig. (2-tailed)	.000	.000
Criterion A	Sum of Squares and Cross-products	323.275	282.075
	Covariance	4.092	3.571
	N	80	80

\*\* . Correlation is significant at the 0.01 level (2-tailed)

### Discussion and Conclusion

The objective of the Physical and Health Education curriculum of the International Baccalaureate (IB) is to enhance students' physical literacy through their active participation in a wide array of sports and activities. Similarly, it emphasises the importance of developing interpersonal abilities to promote collaboration, efficient exchange of ideas, and group endeavour with the intention of embracing a holistic approach to a healthy lifestyle. This inquiry concerns the strategies employed by educational administrators to overcome obstacles during the implementation of cutting-edge international curriculum, specifically International Baccalaureate (IB) programmes (Walker & Lee, 2018). ***To what degree does physical and health education in the IB curriculum promotes personal development, and physical literacy of students?*** Physical activity devoid of supervision and structure may expose students to a greater risk of injury. These injuries can be avoided by adhering to PHE lesson protocols and incorporating appropriate warm-up routines. Furthermore, the integration of game terminology and the implementation of assessments can significantly improve students' comprehension and advancement in physical education. The IB curriculum's emphasis on health and physical education is pivotal in fostering students' personal growth and physical literacy. This finding of this study suggests that the implemented educational initiatives and support systems were successful in facilitating the improvement of students' physical literacy abilities during the transition to IB curriculum as seen in (*Table 1*). it is critical to maintain a steadfast commitment to monitoring and analysing student performance in order to guarantee that teachers and students are provided with the essential academic support and motivation required to flourish. Consistently prioritising the establishment of an inclusive and supportive educational setting will ensure that all students continue to experience favourable progress and development supported by the study of Hung & Liu, (2023) Finally, through the implementation of the IBMYP, teachers are able to actively respond to the two distinct education systems in terms of curriculum organisation, teaching approaches, assessment methods, and educational progression by utilising innovative pedagogies. The observational report identified a number of issues, including classroom disruptions, the teaching approach of the teachers, the students' lack of knowledge regarding physical and health education, the participation of female students, and the development of students' physical fitness. However, there was a notable surge in the students' engagement in physical activities and physical fitness levels following

terms one and two of the academic year after the implementation of the IB physical and health curriculum. As an example of the strategies implemented by the school administration to resolve these issues, workshops for teachers to better their teaching methods and classroom management skills were organised. Furthermore, in an endeavour to improve the learning environment, the institution updated its facilities and resources. Teachers professional learning community (Lin et al., 2018); The students demonstrated a significant enhancement in their physical fitness levels and exhibited increased participation in physical activities both inside and outside of school as a consequence of these interventions. ***Are there any differences in students' term 1 and term 2 assessment criteria scores for physical and health education?*** In order to address this inquiry, it is crucial to conduct a comprehensive analysis of the evaluation criteria for both term 1 and term 2 in order to detect differences in the scoring process. When comparing assessment results between terms, it is essential to additionally consider characteristics such as student participation, progress over time, and adherence to instructional procedures. Through a thorough assessment, teachers may offer specific comments and assistance to enhance students' performance in physical and health education over the duration of the academic year. The data analysis reveals that students' term two grades indicate that they have demonstrated progress in both their motor skills and comprehension of health concepts across the criterion ABCD throughout the academic year 2022/2023. See (Figure 2) Mean Comparison 'Term 1', 'Term 2' by 'Assessment Criteria'. The progress may be ascribed to the IB physical and health education curriculum implemented, teachers' professional development in developing lesson plan and unit that allow the students to explore the key concept, factual, procedural, and conceptual knowledge of each unit, students' effort in their classes, as well as the teachers' successful teaching tactics. We also performed a correlation analysis to find out how the International Baccalaureate Physical and Health Education Curriculum affected students' physical literacy and the development of social skills for a healthy lifestyle, and reinforce their progress in physical literacy for students' growth (Pulimeno et al., 2020). ***Is there a correlation between student criteria (ABD-scores) in term 2 of the academic year 2022-2023?*** We conducted a correlation analysis to determine how the International Baccalaureate Physical and Health Education Curriculum affected students' physical literacy and the development of social skills for a healthy lifestyle by analysing students' criteria ABD assessment score. Correlation analysis result was significant at the  $p < .01$  across all the variables as seen in (table 5) Pearson Correlation Term 2 Criterion ABD it will be crucial for instructors to persist in evaluating students' progress and offering focused assistance to guarantee ongoing development and achievement in physical and health education. The efficiency of physical education classes, as well as the physical literacy and involvement of students in physical activities, are heavily influenced by the self-efficacy and physical literacy of teachers (Sum et al., 2018). Through fostering collaboration with students and providing tailored feedback and assistance, educators may facilitate the realisation of each individual's maximum potential and attainment of academic achievement in these crucial areas of study. ***Focus group Interview.*** During the focus group interview, students articulated their comprehension of the four criteria in IB physical and health education and the interconnectedness of these criteria within the context of their personal learning experiences. The programme not only enhanced their athletic ability but also imparted vital social skills such as teamwork, communication, and empathy. The students expressed how engaging in physical activities and acquiring knowledge about health and wellness has had a beneficial effect on their general well-being and outlook. The aim is to enhance students' well-being, knowledge, academic achievement, and their motivation to continue engaging in physical activity outside of physical education classes (Behzadnia et al., 2018). In summary, the focus group interview emphasised the significance of a comprehensive approach to education that gives priority to both physical and mental well-being. They discussed the service learning projects they engaged in and how it facilitated the growth of their empathy and a feeling of belonging to a community. They initiated a school community initiative focused on promoting awareness about the significance of participating in physical activities within the school community. This endeavour

resulted in a notable rise in student involvement and general well-being. According to Skrzypiec et al.,(2014) The findings suggest that IB MYP schools are actively working towards fostering the following attributes in IB MYP students: introspection, perseverance, interpersonal connections, institutional connections, and self-assurance. In addition, only a small proportion of IB MYP students had below-average levels of well-being.

### **Implication of Study**

The International Baccalaureate Physical and Health Education Curriculum affected students' physical literacy and the development of social skills for a healthy lifestyle by emphasising the importance of regular physical activity and promoting positive behaviour choices. Students were able to explore each unit through a variety of engaging and interactive activities designed to enhance their understanding and encourage participation. The four assessment criteria in the IB physical and health education curriculum provided the students with a comprehensive evaluation of their progress and achievement in the subject. As they were able to use the knowledge they acquired in criterion (A) to demonstrate their understanding of health concepts and demonstrate their skills in a variety of physical activities, they designed a plan in criterion (B) to prepare themselves for performance in criterion (C ) and they were able to reflect on their performance for future improvement in criterion (D ) to enhance their overall physical fitness and well-being.

### **Conclusion**

In conclusion, this study emphasises the significance of student well-being in attaining academic achievement and the overall beneficial influence of the International Baccalaureate Physical and Health Education Curriculum on students' physical literacy and the cultivation of social skills for a healthy way of life. Through the integration of diverse physical activities and mindfulness techniques, students saw improvements in both their physical well-being and cognitive capacities. This all-encompassing method of teaching not only enhances students' academic performance but also equips them with the necessary skills and knowledge for a prosperous and fulfilling life. In the future, it is important for schools to maintain a focus on the holistic welfare of students in order to guarantee their maximum development academically and personally.

### **Recommendation**

This study reaffirms that the implementation of IB physical and health education in schools is essential for the holistic development of students because the curriculum focused on both the acquisition of knowledge and practical skills, students are better prepared to manage their own health and well-being. It is crucial for educators to offer chances for self-reflection and goal setting to guarantee that students remain consistently motivated to enhance and sustain their physical fitness levels. In conclusion, allocating resources towards high-quality physical and health education programmes can result in kids who are both physically and mentally better, leading to increased happiness and preparedness for future endeavours.

### **References**

- Behzadnia, B., Adachi, P. J. C., Deci, E. L., & Mohammadzadeh, H. (2018). Associations between students' perceptions of physical education teachers' interpersonal styles and students' wellness, knowledge, performance, and intentions to persist at physical activity: A self-determination theory approach. *Psychology of Sport and Exercise*, 39, 10–19. <https://doi.org/10.1016/j.psychsport.2018.07.003>
- Colombo-Dougovito, A. M., & Lee, J. (2021). Social skill outcomes following physical activity-based interventions for individuals on the autism spectrum: A scoping review spanning young childhood



- through young adulthood. *Adapted Physical Activity Quarterly*, 38(1), 138–169. <https://doi.org/10.1123/APAQ.2019-0080>
- Creswell, J., Shope, R., Clark, V. L. P., & Green, D. O. (2006). How interpretive qualitative research extends mixed methods research. *Research in the Schools*, 13(1), 1–11. <http://www.msra.org/docs/rits-v13n1-complete.pdf#page=55>
- Dever, R. (2019). The international baccalaureate middle years programme (myp) in us middle level schools. *International Handbook of Middle Level Education Theory, Research, and Policy*, 31–40. <https://doi.org/10.4324/9781351122115-3>
- Dickson, A. (2019). *International Baccalaureate's Middle Years Programme: Liberation or suffocation?* [Murdoch University]. <https://researchportal.murdoch.edu.au/esploro/outputs/doctoral/International-Baccalaureates-Middle-Years-Programme-Liberation/991005543023707891>
- Eather, N., Wade, L., Pankowiak, A., & Eime, R. (2023). The impact of sports participation on mental health and social outcomes in adults: a systematic review and the 'Mental Health through Sport' conceptual model. In *Systematic Reviews* (Vol. 12, Number 1). <https://doi.org/10.1186/s13643-023-02264-8>
- Harvey, S., Kirk, D., & O'Donovan, T. M. (2014). Sport Education as a pedagogical application for ethical development in physical education and youth sport. *Sport, Education and Society*, 19(1), 41–62. <https://doi.org/10.1080/13573322.2011.624594>
- Hung, L. C., & Liu, M. H. (2023). From a public school to an IB school: experiences and challenges for curriculum transformation in a junior high school in Taiwan. *Asia Pacific Education Review*. <https://doi.org/10.1007/s12564-023-09884-8>
- Ip, P., Ho, F. K. W., Louie, L. H. T., Chung, T. W. H., Cheung, Y. F., Lee, S. L., Hui, S. S. C., Ho, W. K. Y., Ho, D. S. Y., Wong, W. H. S., & Jiang, F. (2017). Childhood Obesity and Physical Activity-Friendly School Environments. *Journal of Pediatrics*, 191, 110–116. <https://doi.org/10.1016/j.jpeds.2017.08.017>
- Kemel, P. N., Porter, J. E., & Coombs, N. (2022). Improving youth physical, mental and social health through physical activity: A Systematic literature review. In *Health Promotion Journal of Australia* (Vol. 33, Number 3, pp. 590–601). <https://doi.org/10.1002/hpja.553>
- Lin, W., Lee, M., & Riordan, G. (2018). The Role of Teacher Leadership in Professional Learning Community (PLC) in International Baccalaureate (IB) Schools: A Social Network Approach. *Peabody Journal of Education*, 93(5), 534–550. <https://doi.org/10.1080/0161956X.2018.1515833>
- Lynch, T., & Soukup, G. J. (2017). Primary physical education (PE): School leader perceptions about classroom teacher quality implementation. *Cogent Education*, 4(1). <https://doi.org/10.1080/2331186X.2017.1348925>
- Packham, A., & Street, B. (2019). The effects of physical education on student fitness, achievement, and behavior. *Economics of Education Review*, 72, 1–18. <https://doi.org/10.1016/j.econedurev.2019.04.003>
- Pakhalchuk, N. O., & Holyuk, O. A. (2018). Problems of physical activity in vocational training of future teachers. *Physical Education of Students*, 22(1), 45. <https://doi.org/10.15561/20755279.2018.0107>
- Pollack, J. (2015). Understanding the divide between the theory and practice of organisational change. *Organisational Project Management*, 2(1), 35. <https://doi.org/10.5130/opm.v2i1.4401>
- Primo, L., González-Hernández, J., Yang, Y., & López de Subijana, C. (2023). Predicting social skills in disadvantaged Chinese high school students through physical education. *Frontiers in Psychology*, 14. <https://doi.org/10.3389/fpsyg.2023.1149223>
- Prins, R. G., Van Empelen, P., Te Velde, S. J., Timperio, A., Van Lenthe, F. J., Tak, N. I., Crawford, D., Brug, J., & Oenema, A. (2010). Availability of sports facilities as moderator of the intention-

- sports participation relationship among adolescents. *Health Education Research*, 25(3), 489–497. <https://doi.org/10.1093/her/cyq024>
- Pulimeno, M., Piscitelli, P., Colazzo, S., Colao, A., & Miani, A. (2020). School as ideal setting to promote health and wellbeing among young people. In *Health Promotion Perspectives* (Vol. 10, Number 4, pp. 316–334). Tabriz University of Medical Sciences. <https://doi.org/10.34172/hpp.2020.50>
- Reinders, N. J., Branco, A., Wright, K., Fletcher, P. C., & Bryden, P. J. (2019). Scoping review: Physical activity and social functioning in young people with autism spectrum disorder. In *Frontiers in Psychology* (Vol. 10, Number FEB). <https://doi.org/10.3389/fpsyg.2019.00120>
- Resnik, J. (2012). The denationalization of education and the expansion of the international baccalaureate. *Comparative Education Review*, 56(2), 248–269. <https://doi.org/10.1086/661770>
- Saxton, S. E., & Hill, I. (2014). The International Baccalaureate (IB) Programme: An International Gateway to Higher Education and Beyond. *Higher Learning Research Communications*, 4(3), 42. <https://doi.org/10.18870/hlrc.v4i3.123>
- Serrat, O. (2017). Theories of Change. In *Knowledge Solutions* (pp. 237–243). Springer Singapore. [https://doi.org/10.1007/978-981-10-0983-9\\_24](https://doi.org/10.1007/978-981-10-0983-9_24)
- Skrzypiec, G., Askill-Williams, H., Slee, P., & ... (2014). IB Middle Years Programme (MYP): Student social-emotional well-being and school success practices. *Adelaide, Australia ...* <https://ibo.org/globalassets/new-structure/research/pdfs/socialemotionalfinalreport.pdf%0Ahttps://www.ibo.org/globalassets/publications/ib-research/myp/socialemotionalfinalreport.pdf>
- Smedegaard, S., Christiansen, L. B., Lund-Cramer, P., Bredahl, T., & Skovgaard, T. (2016). Improving the well-being of children and youths: a randomized multicomponent, school-based, physical activity intervention. *BMC Public Health*, 16(1), 1–11. <https://doi.org/10.1186/s12889-016-3794-2>
- Sum, K. W. R., Wallhead, T., Ha, S. C. A., & Sit, H. P. C. (2018). Effects of physical education continuing professional development on teachers' physical literacy and self-efficacy and students' learning outcomes. *International Journal of Educational Research*, 88, 1–8. <https://doi.org/10.1016/j.ijer.2018.01.001>
- Syrmpas, I., & Digelidis, N. (2014). Physical education student teachers' experiences with and perceptions of teaching styles. *Journal of Physical Education and Sport*, 14(1), 52–59. <https://doi.org/10.7752/jpes.2014.01009>
- Valencia, R. T. M., Salazar, C. M., Sánchez, A. I. A., Ramos-Carraza, I. G., & Sánchez, L. F. R. (2023). Recreation, social skills and coping strategies during the first stage of COVID-19 confinement in mexican adolescents. *E-Balonmano.Com: Revista de Ciencias Del Deporte*, 19(2), 65–178. <https://doi.org/10.17398/1885-7019.19.165>
- Vogel, I. (2012). guide to working with Theory of Change for projects. *Ecosystem Services for Poverty Alleviation*, 1–42.
- Walker, A., & Lee, M. (2018). Weaving Curriculum Connections in International Baccalaureate (IB) Schools. *Peabody Journal of Education*, 93(5), 468–485. <https://doi.org/10.1080/0161956X.2018.1515837>



## Home Advantage and Away Disadvantage of Teams in Türkiye Super League Derbies

**Ümit Kuvvetli<sup>1\*</sup>, Özgül Vupa Çilengiroğlu<sup>2</sup>**

<sup>1</sup>İzmir Bakircay University, Faculty of Economics and Administrative Sciences, Business Administration, 35665, Izmir, Türkiye

<sup>2</sup>Dokuz Eylül University, Faculty of Science, Statistics, 35390, Izmir, Türkiye

\*Corresponding author e-mail: umit.kuvvetli@bakircay.edu.tr

### Abstract

*In all professional team sports, the team playing at home derives an advantage and the team playing away has a disadvantage. The extent of this advantage and disadvantage varies both between sports and between different competitions within each sport. In soccer, home advantage (HA) or away disadvantage (AD) has always been a particularly important factor in determining the outcome of a game, however, there is a limited number of studies that examine team-specific HA and AD and determine the nature and cause of these factors. Although football is the most followed sport in Türkiye, the matches played between the 4 major football teams with the most championships in the league are followed by all football fans in the country. These matches called derbies, not only directly affect the championship race in the league, but also determine the national agenda from time to time. In this study, team-specific HA and AD values are estimated using data from 276 derby matches played between the 2000/2001 and 2022/2023 seasons. Using Generalized Estimating Equations and Poisson regression, it is determined that all teams have a statistically significant HA in derby matches played at home, with rates ranging from 61.8% to 65.1%. In terms of AD, it was found that all teams except Fenerbahçe have a statistically significant AD value in derbies. When the results of this study are compared with other studies in the literature, it is found that the HA of the big teams in derby matches is lower compared to other matches in the league. However, although the four teams do not statistically experience AD in away matches against their other rivals in the league, this is not the case in derbies and the AD values of the teams increase. There are studies in the literature that there are many factors such as fan support, referee bias, distance, altitude, and psychological factors that affect the HA of the teams. On the other hand, the results of this study indicate that factors such as the strength of the opponents, inter-team rivalry, etc. are also effective on the HA and AD of the teams.*

**Keywords:** Football, Home Advantage, Away Disadvantage, Generalized Estimating Equations, Poisson Regression

### INTRODUCTION

Derby is the name given to the rivalry matches between two teams in close geographies. However, as a result of the developing economic conditions and the industrialisation of football, the concept of derby has also expanded. Today, in addition to the matches played between the teams of the same city, the rivalries between clubs with a historical past, economic power, media and public support are also called derbies. Derby matches are matches in which fans show great interest and exhibit a contentious struggle to win. Derby matches are very exciting for reasons such as previous competitions in the history of the teams, tension between fans, regional rivalry, political, religious, class or cultural background. Although the matches of the best teams in the league are eagerly awaited by the fans throughout the season, derbies have a special place because of these characteristics. The most common sport in Türkiye is football and the matches between the so-called Big Four teams are the most famous derbies in the country. These four teams are the most successful and well-established teams in Turkish football and there is a great rivalry between their fans. The matches between Beşiktaş, Fenerbahçe, Galatasaray and Trabzonspor are among the most important football matches in Türkiye and often make the country's agenda.



With the excitement and adrenaline experienced in derby matches, the pressure on players and coaches becomes an important factor affecting performance. In this case, coaches give importance to studies to change the result of the match in order to be successful in derbies. Home advantage (HA) and away disadvantage (AD) have always been the most important factors in determining the outcome of a match in football. HA is used as a concept which means that teams win more matches and score more goals than their opponents at their home grounds. Similarly, AD can be explained as the fact that teams score fewer points and score fewer goals away from home than their opponents. Although there are many studies that calculate league-specific HA (Leite, 2017; Pollard & Gomez, 2014), there are a limited number of studies that examine team-specific HA and AD. Especially the fact that the number of studies examining HA and AD in derby matches is much more limited and the lack of studies specific to Türkiye increases the curiosity in this field.

Baker et al. (2010) analyzed whether derbies are different from other football matches in terms of the number of goals, match results, the number of goal chances of both teams and referee evaluations by using the data of the Bundesliga between 1999-2009 with Poisson regression. In this study, it was concluded that especially in derby matches, playing at home increases the number of goals scored. However, in general, no difference was found between derbies and other regular matches.

Volossovitch et al. (2013) conducted a k-means cluster analysis of HA in derby and non-derby matches of the Premier Brazilian National Football League played from 2007 to 2011 seasons. In the study where they took into account various factors such as match result, number of goals, number of red and yellow cards and distance, they found that HA is an important factor in winning the match in derbies.

Ponzo & Scoppa (2018) examined the importance of spectator support in determining HA by analyzing data from derby matches in Serie A between 1991 and 2013. They find consistent evidence that spectator support tends to influence referee decisions (in terms of penalties, red cards and yellow cards) in favour of the home team using ordered probit analysis and ordinary least squares methods.

The aim of this study is to find team-specific HA and AD values by using the data obtained from the derby matches of the 4 major football teams in Türkiye, which had the most championships between the seasons 2000/2001 and 2022/2023, and to interpret them by comparing with other findings in the literature.

## **MATERIAL AND METHODS**

### **Material**

In this study, HA and AD values specific to the four major teams (Fenerbahçe, Galatasaray, Beşiktaş, Trabzon) are estimated using data from 276 derby matches played in Türkiye between 2000/2001 and 2022/2023 seasons. All matches in a season were played in pairs, one at each team's home ground. All analyses were performed using IBM SPSS Statistics 26 software package.

### **Methods**

#### *The Collection of the Data*

All match data were obtained from the official website of the Turkish Football Federation ([www.tff.org](http://www.tff.org)).

#### *Variables*

Four variables were used to predict the HA and AD of teams in derby matches. Among these variables, 'loc\_code' indicates the location information that determines whether each team is home or away, 'match\_id' indicates the id information specific to each match, 'ability' shows the strength of each team in that season (the team's position in the final league table) and 'goal' indicates the number of goals scored and conceded by each team in the relevant match.

*Statistical Analysis*

The crude HA value for each team was calculated as the percentage of goals scored (GS) and goals conceded (GC) in home derby matches ( $GS/(GS+GC)$ ). Correspondingly, the crude AD for each team was calculated as the percentage of goals conceded in away matches ( $GC/(GS+GC)$ ). A value of 50% of HA or AD for any team indicates that the team does not have HA or AD, a value higher than 50% for HA indicates superior performance in home matches, and a value higher than 50% for AD indicates poor performance in away matches (Kuvvetli, Çilengiroğlu, 2023). This simple approach used in HA and AD calculations is far from being comparable as it does not take into account team ability. For this reason, repeated measures regression analysis with generalised estimating equations (Goumas, 2013, Goumas, 2017) was used and the difference in team ability was included in the model. Repeated measures regression analysis is used when observations occur in pairs and the outcome of interest is linked to each of them. Since the number of goals scored in pairs is discrete, the Poisson regression model (Karlis & Ntzoufras, 2003) was used.

HA and AD were taken from the Poisson regression coefficient ( $\beta$ ) for match location (0 = Away, 1 = Home) for each team using the following equation (Goumas, 2017):

$$HA \text{ and } AD = \frac{\exp(\beta)}{\exp(\beta) + 1} \times 100\%$$

The standard error (SE) for HA and AD can be calculated as follows, where se represents the standard error of beta (Goumas, 2013):

$$SE(HA \text{ and } AD) = HA - \left( \frac{\exp(\beta - se)}{\exp(\beta - se) + 1} \times 100 \right)$$

In these equations, the exponential function  $\exp(\beta)$  is applied to the regression coefficient for match location, and the results are transformed into percentages. The HA represents the estimated percentage of goals scored by the home team, while the AD represents the estimated percentage of goals conceded by the away team. Using this approach, the study aimed to obtain adjusted estimates of HA and AD that consider the impact of match location on goal scoring and conceding, providing a more accurate assessment of the influence of HA and AD in football matches. To test for variation in HA and AD between teams, a chi-square test was carried out. p values less than 0.05 were considered to be significant.

**RESULTS**

The number of home matches played by these teams in derby matches, the number of goals scored and conceded, the crude and adjusted HA values, and the p values showing the statistical significance of the adjusted HA value are summarized in Table 1. The teams in Table 1 are ranked in descending order according to the adjusted HA value adjusted for team ability and the season effect.

**Table 1.** Home advantage (%) for teams in derbies between 2000/2001 to 2022/2023 seasons

Teams	Home Matches	Goals for	Goals against	Home Advantage (%)		
				Crude	Adj (SE)	p-value
Fenerbahce	69	123	69	64.1	65.1 (2.5)	0.000
Galatasaray	69	103	62	62.4	64.4 (2.6)	0.000
Trabzonspor	69	76	96	44.2	63.1 (4.7)	0.007
Besiktas	69	107	82	56.6	61.8 (2.7)	0.000

The adjusted HA values in Table 1 indicate the superiority of the relevant team in home matches against an opponent of equal ability in the derby matches. It is seen that all teams have statistically HA in home matches in derby matches. However, there is no statistical difference ( $\chi^2_3 = 0.2; p = 0.97$ ) between the teams in terms of HA in derby matches.

**V. INTERNATIONAL APPLIED STATISTICS CONGRESS (UYIK - 2024)**  
**İstanbul / Türkiye, May 21-23, 2024**

The number of matches played by teams in derbies, the number of goals they scored and conceded, as well as the crude and adjusted AD, along with the p-values indicating their statistical significance, are summarized in Table 2. The teams listed in Table 2 are arranged in ascending order based on their adjusted AD values.

**Table 2.** Away disadvantage (%) for teams in derbies between 2000/2001 to 2022/2023 seasons

Teams	Home Matches	Goals for	Goals against	Away Disadvantage (%)		
				Crude	Adj (SE)	p-value
Fenerbahce	69	82	83	50.3	52.5 (3.5)	0.482
Besiktas	69	82	105	56.1	56.9 (3.0)	0.027
Trabzonspor	69	77	119	60.7	58.3 (3.1)	0.009
Galatasaray	69	68	102	60.0	60.3 (3.9)	0.012

In Table 2, the adjusted AD values indicate the disadvantage of the teams in away matches against an opponent of equal ability in derbies. Although all of the teams have a statistical HA, Table 2 shows that the AD values for all teams are more than 50% and they have an AD. However, for all teams, except Fenerbahçe, the AD values are statistically significant. Additionally, it has been determined that there is no statistically significant difference between teams in terms of the AD ( $\chi^2_3 = 2.2; p = 0.54$ ).

Kuvvetli & Cilengiroglu (2023) estimated the HA and AD values for Turkish Super League teams by utilising the method used in this study. Similarly, Kuvvetli (2024) used the same method to estimate the HA and AD values of Turkish teams in European competitions. In this study, the HA and AD values of the teams in derby matches are compared with the results of these studies in the literature and summarized in Tables 3 and 4.

**Table 3.** Home advantage (%) for teams in derbies, league, and European competitions

Teams	Derby matches	Türkiye Super League	European Competition
Besiktas	61.8	68.4	73.4
Fenerbahce	65.1	70.3	67.5
Galatasaray	64.4	70.4	66.3
Trabzonspor	63.1	66.8	70.9

The HA values of the teams in the league, derby matches, and European competitions were compared using Friedman's test and it was concluded that the HA of the teams differed according to different opponents ( $p=0.05$ ). In the pairwise comparisons made by using Wilcoxon sign test, it was concluded that the difference in question was caused by derby matches and that the HA did not differ in league and European matches ( $p=0.581$ ).

**Table 4.** Away disadvantage (%) for teams in derbies, league, and European competitions

Teams	Derby matches	Türkiye Super League	European Competition
Besiktas	56.9	49.3	59.7
Fenerbahce	52.5	46.7	54.6
Galatasaray	60.3	48.8	58.7
Trabzonspor	58.3	52.1	58.9

When the AD values of the teams were compared using Friedman's test, it was concluded that the AD against different opponents varied ( $p=0.039$ ). In pairwise comparisons using Wilcoxon sign test, it was observed that the difference in organizations was caused by league and derby ( $p=0.068$ ) and league and European matches ( $p=0.068$ ). Despite this difference, it was concluded that AD did not differ in derby and European matches ( $p=0.273$ ).

## DISCUSSION AND CONCLUSION

The purpose of this study is to calculate the advantage of being a home team and the disadvantage of being an away team for teams in derbies in Türkiye. To achieve this goal, the study employs the



Generalized Estimating Equations and Poisson Regression methods previously used by Goumas (2017) and Kuvvetli & Çilengiroglu (2024). One advantage of this method is that it provides individualized HA estimates for each team, thereby avoiding the influence of other teams' results. Additionally, unlike other methods, it incorporates team abilities into the model. Previous methods tended to "regress" each team's HA towards the mean HA for all teams combined, which reduced the ability to detect differences between teams.

In the literature, the number of studies conducted at team level is limited, and most of them are related to HA. Pollard and Gomez (2009) examined HA for teams in the South-West Europe region. In their study, the HA values for teams in France ranged from 59.2% to 74.4%, in Italy from 61.0% to 71.8%, in Portugal from 61.0% to 71.3%, and in Spain from 67.1% to 72.0%. Armatas and Pollard (2014) similarly estimated HA for individual teams in Greek football to range from 49.6% to 80.5%. Pollard et al. (2008) determined that different Brazilian teams had a HA ranging from 57.5% to 74.9%. These studies have shown that while factors such as team quality, crowd size, stadium capacity, and other factors may vary, the majority of teams have a HA. In the studies using the same method used in this study, it was determined that the HA ranged between 56.2% and 81.8% for the individual teams in the Turkish Super League and between 37.9% and 72.9% for the individual teams in the Turkish 1st League, while the AD ranged between 46.7% and 65.4% for the teams in the Turkish Super League and between 46.9% and 73.7% for the teams in the Turkish 1st League (Kuvvetli & Cilengiroglu, 2023, Kuvvetli, 2023). In terms of the Turkish Super League, HA is calculated as 61.5% (Seckin & Pollard, 2008). The HA values obtained in this study for teams in the derby matches are in line with the literature. On the other hand, Baker et al. (2010), using Bundesliga data, concluded that the HA in derby and other matches is the same, which is not valid for the Turkish league.

The results of this study show that the HA of the big teams in Türkiye in derby matches played among themselves is lower compared to other matches in the league. It is possible to explain this situation with factors such as the home team players being under more pressure in derby matches compared to other matches, the away team's habit of playing in similar environments, the quality of the away team being above the league, referees being more careful in derby matches and tactical differences.

In terms of AD, it is observed that all big teams have AD in derbies, although they do not have AD in the league as a whole. It is an important result that the AD in derbies is quite close to the values in European competitions. Factors such as the fact that the teams in study have more fan support than many home teams in their away games against other teams in the league, and that the referees are more tolerant towards the big teams of the league compared to the small teams can be shown as the reasons why the AD of these teams in the league is lower than the AD in derbies and European matches.

In the literature, there are studies indicating that there are many factors such as fan support, referee bias, distance, altitude and psychological factors that affect the HA of teams. On the other hand, the results of this study show that factors such as the strength of rivals, inter-team rivalry, etc. are also effective on the HA and AD of the teams.

The study is based on the data obtained from the derby matches played between the teams considered as the big four in Türkiye. It does not include other local derby matches, especially those played between teams in the same city (such as Göztepe- Karşıyaka in Izmir). However, in the preferred method of the study, each team was analyzed separately. In this method, in which the effect of team ability is controlled, analyzing the teams separately has increased the statistical power in determining the difference between the teams. In addition, although this study found that the HA and AD values of teams in derby matches, the possible factors effecting these values (distance, number of fans, competition between teams etc.) may be the subject of future studies.

## References

- Armatas V., Pollard R., 2014. Home advantage in Greek football. *European Journal of Sport Science*, 14 (2), 116-122.
- Bäker, A., Mechtel, M., Vetter, K., 2012. Beating thy Neighbor: Derby Effects in German Professional Soccer, *Jahrbücher für Nationalökonomie und Statistik*, 232 (3), 224-246. <https://doi.org/10.1515/jbnst-2012-0304>.
- Goumas C., 2013. Modelling home advantage in sport: a new approach. *International Journal of Performance Analysis in Sport*; 13, 428–439.
- Goumas C., 2017. Modelling home advantage for individual teams in UEFA Champions League football. *Journal of Sport and Health Science*, 6, 321–326.
- Karlis, D., Ntzoufras, I., 2003. Analysis of sports data by using bivariate Poisson models. *Journal of the Royal Statistical Society: Series D (The Statistician)*, 52: 381-393. <https://doi.org/10.1111/1467-9884.00366>.
- Kuvvetli, Ü., Vupa Çilengiroğlu, Ö., 2023. Statistical modelling of home advantage and away disadvantage of Turkish super league teams. *Gazi Beden Eğitimi ve Spor Bilimleri Dergisi*, 28 (3), 206-214.
- Kuvvetli Ü., 2023. An investigation on home advantage and away disadvantage of teams in TFF 1. League, [TFF 1. ligde takımların ev sahibi avantajı ve deplasman dezavantajı üzerine bir araştırma], *Sportmetre*, 21, (Special Issue for 100th year), 78-90.
- Kuvvetli, Ü., 2024. Home Advantage and Away Disadvantage of Turkish Football Teams in European Competitions. *Gazi Beden Eğitimi Ve Spor Bilimleri Dergisi*, 29 (2), 61-69. <https://doi.org/10.53434/gbesbd.1378119>.
- Kuvvetli Ü., Çilengiroğlu Ö.V., 2024. Home advantage and away disadvantage of teams in champions league: is it valid for all teams and against every opponent?. *Journal of Human Kinetics*, 92, 161-179. <https://doi.org/10.5114/jhk/175398>.
- Leite W.S.S., 2017. Home Advantage: Comparison between the Major European Football Leagues, *Athens Journal of Sports*, 4 (1), 65-74.
- Pollard, R., Gómez M.A., 2009. Home advantage in football in South-West Europe: long-term trends, regional variation, and team differences, *European Journal of Sport Science*, 9 (6), 341-352.
- Pollard, R., & Gómez, M. A., 2014. Components of home advantage in 157 national soccer leagues worldwide. *International Journal of Sport and Exercise Psychology*, 12 (3), 218–233.
- Pollard, R., Silva, C. D., Medeiros, N. C., 2008. Home advantage in football in Brazil: differences between teams and the effects of distance traveled. *Revista Brasileira De Futebol (The Brazilian Journal of Soccer Science)*, 1(1), 3–10.
- Ponzo, M., Scoppa, V., 2018. Does the home advantage depend on crowd support? Evidence from same-stadium derbies. *Journal of Sports Economics*, 19 (4), 562-582. DOI:10.1177/1527002516665794.
- Seçkin A., Pollard R., 2008. Home advantage in Turkish professional soccer, *Perceptual and Motor Skills*, 107, 51-54.
- Volossovitch A., Cruz J., Ferreira A.P., Carita A.I., 2013. Home advantage in derby and non-derby matches of premier Brazillian National Football League played from 2007 to 2011 seasons. *Performance Analysis of Sport IX*. (Editors: Peters D., O'Donoghue, P.). Routledge. 50-56, New York. <https://doi.org/10.4324/9780203080443>.

## Conflict of Interest

The authors have declared that there is no conflict of interest.

## Author Contributions

The contributions of the authors to the study are equal.

## An Evaluation Study on Counterfactual Explanations of Bank Failure Prediction Models

Seyma Gunonu<sup>1</sup>, Gizem Altun<sup>1</sup>, Mustafa Cavus<sup>1\*</sup>

<sup>1</sup>Eskisehir Technical University, Department of Statistics, Eskişehir, Türkiye

\*Corresponding author e-mail: mustafacavus@eskisehir.edu.tr

### Abstract

*One way to address today's banking sector's financial crises and fluctuations is through implementing various strategies. Using machine learning models with high predictive power is one of these strategies, bank failure prediction models are utilized to determine the risk of financial instability. However, while these models estimate the risk of bank failures, they are conservative in counteractions that can be taken against failure due to the black-box structure of these models. This limitation of the bank failure models can be overcome with the help of counterfactual explanations (CEs) used in interpretable machine learning. They produce what-if scenarios that show necessary changes to the input data to change the model prediction. The CEs of bank failure prediction contribute to understanding financial crises and taking action to prevent failure. The CEs provided by these models can assist financial regulators and bank managers. There are three methods for generating CEs: Multi-Objective Counterfactual Explanations (MOC), Nearest Instance Counterfactual Explanations (NICE), and WhatIf (WI). These methods are proposed to serve a specific purpose, thus they generate different CEs in different structures. Therefore, evaluating CEs is critical to determine whether these explanations conform to some properties that CEs provide. Certain properties must be met; assessing these allows us to obtain reliable explanations. This study evaluates the generated CEs using the pre-trained bank failure models' MOC, NICE, and WI methods. Thus, we aim to identify the most effective method for generating counterfactual explanations based on the properties of bank failure prediction models. Finally, the CEs generated by these methods can help us better understand the causes and symptoms of financial crises and contribute to developing more effective strategies to deal with future crises.*

**Keywords:** Algorithmic recourse, Evaluating counterfactuals, Actionable explanations, Contrastive explanations, Explainable artificial intelligence

### INTRODUCTION

Managing risks in the financial sector, especially predicting important events such as bank bankruptcy, is a complex and sensitive process. Banks are an important part of the economic system and their health can be monitored by various financial criteria. In recent years, models have been used to predict the probability of bankruptcy (Petropoulos et al., 2020; Kristof and Virag, 2022). However, these predictions are often made using complex and difficult-to-understand models known as the “black box”, which poses the challenge of fully understanding their inner workings. In this context, explainable artificial intelligence tools emerge as valuable for understanding and interpreting model predictions. Although machine learning is focused on prediction, it is increasingly used to make high-risk decisions. The negative consequences must be reversed in critical situations such as bank failure. In that case, Counterfactual Explanations (CEs) provide explanations to alter the input features while minimizing the change in the output (Molnar, 2020). CEs generate a synthetic data point close to an existing one so that the new synthetic data point is classified differently from the original one (Wachter et al., 2017). A good counterfactual explanation should provide three basic characteristics: validity, diversity, and plausibility (Karimi et al., 2020). CEs are used to improve our models' understanding of cause-effect relationships



and increase the likelihood of avoiding a bank's failure. These explanations can be helpful by considering the key factors, as these factors are variables in our data set, that affect the probability of a particular bank failing and how we can transform these variables into the probability that a bank will not fail.

There are different methods of generating CEs and each produces different counterfactuals in terms of their characteristics. Therefore, it is important to select the most appropriate method to evaluate each technique's advantages and limitations. In this study, we compared the CEs generation methods Multi-Objective Counterfactual Explanations (Dandl et al., 2020), What-If Counterfactual Explanations (Wachter et al., 2017) and Nearest Instance Counterfactual Explanations (Brughmans and Martens, 2022) for bank failure prediction problem. The pre-trained models are used to generate counterfactuals and the results are given with the statistical hypothesis tests. The rest of the study is structured as follows: first, we briefly introduce counterfactual explanations, and the experiments and results are given in the next section. Then, the concluding remarks and further research strategies are given in the last section.

## MATERIAL AND METHODS

In this section, the definition, desired characteristics, and the generation methods of the counterfactual explanations are given.

### Counterfactual Explanations

Consider a dataset  $D = \{(x_i, y_i)\}_{i=1}^n$ , where each  $x_i$  represents a  $d$  dimensional feature vector from  $X$ , and  $y_i$  denotes the corresponding binary label from  $Y$ . The objective is to train a classifier  $f: X \rightarrow Y$  that aims to minimize the loss function  $L(f) = P[Y \neq f(X)]$  which measures the probability of misclassification. A counterfactual  $x' \in R$  of an interested observation  $x \in R$  is calculated through an optimization problem  $x' = \arg \min_{x'} L(f, x, x')$  where  $L(f, x, x')$  measuring the deviation between the predicted outcome for  $x$  and the desired outcome for  $x'$ , given the trained classifier  $f$ . The classical optimization process aims to find the closest counterfactuals  $x'$  to the observation  $x$ ; however, recent counterfactual generation methods consider several constraints. These constraints determine the quality or characteristics of counterfactual explanations explained in the following section.

### The Characteristics of Counterfactual Explanations

The useful counterfactual explanations should have some characteristics in the following (Wachter et al., 2017; Dandl et al., 2023). **Actionability**. To distort the field of counterfactual explanation input, we must see that we can only distort actionable features. For example, we cannot change gender or race. **Sparsity**. The idea is to change a small number of features in the counterfactual. **Validity**. The objective is to minimize the distance between the counterfactual  $x'$  and the original data point  $x$  while ensuring that the model output on the counterfactual matches the desired label  $y' \in Y$ . **Proximity**. The distance between factual and counterfactual features should be small. **Plausibility**. The CEs should be realistic and close to the data manifold. **Diversity**. The CEs should not be limited to just one, but also provide several options. Many counterfactual generation methods prioritize different characteristics of the counterfactuals in the optimization phase.

### Counterfactual Generation Methods

We consider three of the most commonly used counterfactual methods Multi-Objective Counterfactual Explanations, What-If Counterfactual Explanations Method, and Nearest Instance Counterfactual Explanations.

**What-If Counterfactual Explanations**. The What-if Counterfactual Explanations Method (WI) identifies observations closest to the target observation  $x$  among other observations in terms of Gower distance by solving the optimization problem  $x' \in \arg \min_{x \in X} d(x, x')$  (Wexler et al., 2019).

**Multi-Objective Counterfactual Explanations**. The Multi-Objective Counterfactual Explanations

Method (MOC) aims to find counterfactuals corresponding to the *validity*, *proximity*, *sparsity*, and *plausibility* by solving a multi-objective optimization problem  $x' \in \min_x[o_1(f(x), y'), o_2(x, x'), o_3(x, x'), o_4(x, X)]$  where the objectives correspond to the desired properties, *validity*, *proximity*, *sparsity*, and *plausibility*, respectively (Dandl et al., 2020).

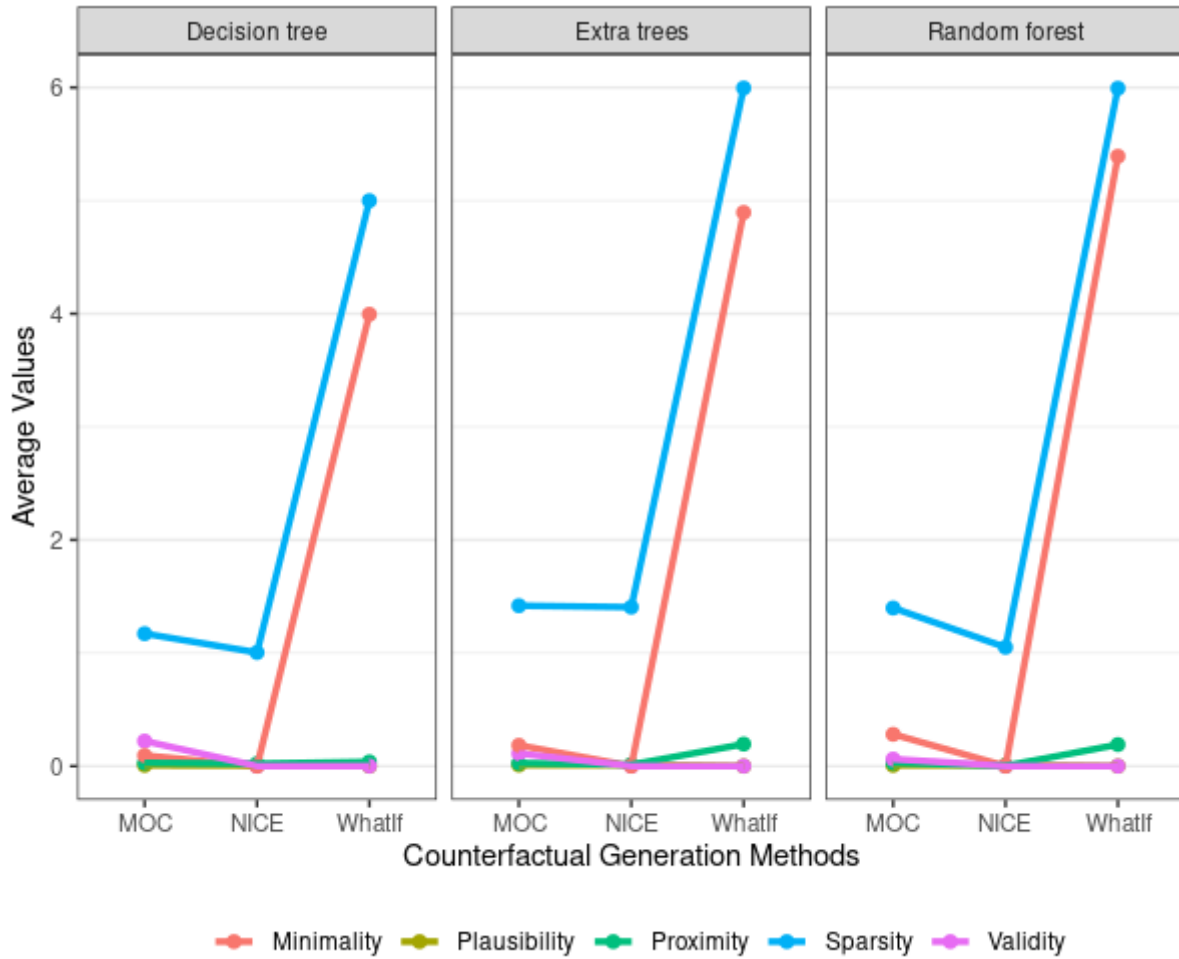
**Nearest Instance Counterfactual Explanations.** The nearest instance counterfactual explanations method (NICE) finds the observations most similar to the interested observation utilizing the heterogenous Euclidean overlap measure (Brughmans and Martens, 2022).

## EXPERIMENTS AND RESULTS

In this part, we evaluate the quality of counterfactual explanations generated by three different methods on the pre-trained bank failure prediction models which show competing performance in case of imbalancedness and out-of-time horizon (Gunonu et al., 2023).

To gain deeper insights into the operationalization of CEs and their fine-tuning, we changed some of the parameters of each method. The default state of all parameters was used for each method. Changes were made depending on our data set to produce a counterfactual explanation in 3 different parameters only found in the methods. The `n_counterfactuals` parameter in the what-if method determines the number of counterfactuals generated for a given input instance. This parameter allows the user to control how many counterfactuals will be created. It will be useful to produce more counterfactual examples to understand the model's decision-making process more deeply and to examine its predictions on a wide scale. The computational cost may increase when larger numbers are produced. The parameter value is used as 10L. In the MOC method, changes were made to the `n_generations` parameter. The operational framework of the MOC method is based on Nondominated Sorting Genetic Algorithm II (NSGA-II). This parameter used here is a genetic algorithm and a generation-specific parameter for genetic algorithms and is used to control how many generations the genetic algorithm will evolve the population. The optimal value in this parameter may vary depending on the data set, and this value can be determined by trial and error method. We may obtain different results depending on various reasons such as the size of the data set, the model's predictions, and the complexity of the problem. In this study, the 10L value, determined through the trial and error method, was used for our data set. In the NICE method, we set the `return_multiple` parameter to `TRUE` to return all samples within the desired probability range of the desired class prediction, depending on the data set. The codes for reproducing the experiments in this section are accessible at the repository: [https://github.com/seymagnn/UYIK2024\\_Counterfactual\\_Explanations\\_of\\_Bank\\_Failure\\_Prediction\\_Models](https://github.com/seymagnn/UYIK2024_Counterfactual_Explanations_of_Bank_Failure_Prediction_Models).

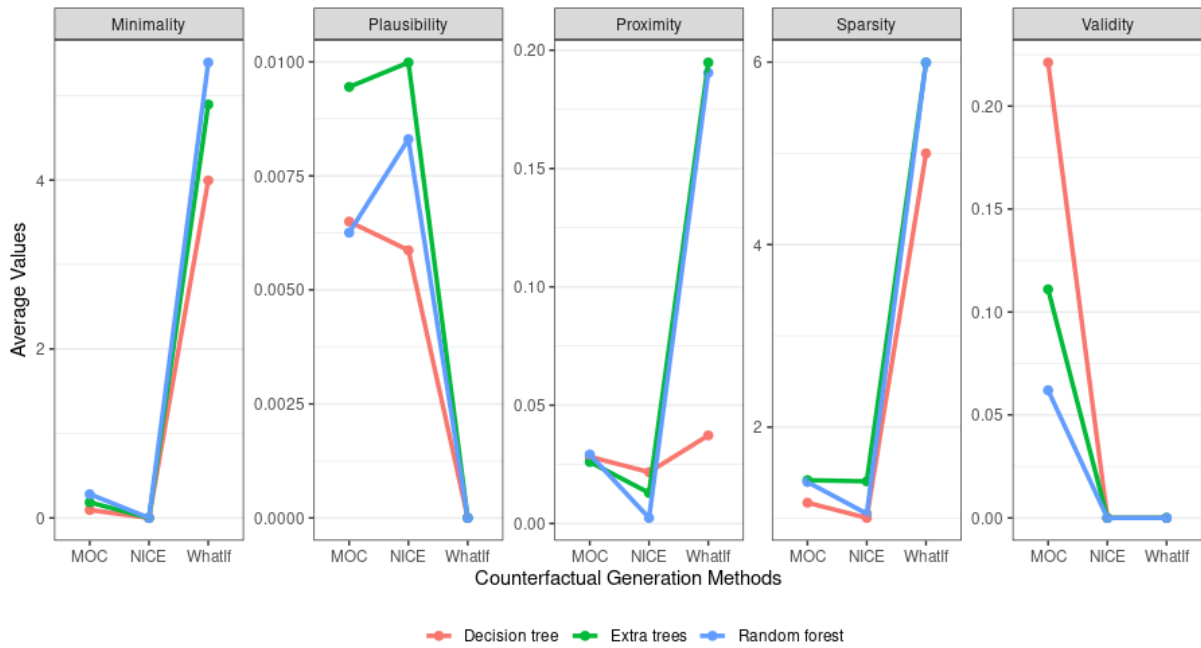
We generated counterfactuals for three models *decision tree*, *extra trees* (Geurts et al., 2006), and *random forest* (Breiman, 2001) using each method for all banks that are predicted as failed. The average values of quality metrics of the generated counterfactuals by the methods on the models are given in Figure 1 which makes it easier to observe the central tendencies of these quality metrics with their average values.



**Figure 1.** The averages of the quality metrics for the methods

The decision tree has the highest average values, especially for the *sparsity* and *validity* metrics. This indicates that the decision tree performs better on these quality metrics. However, it shows lower values in the *plausibility* and *proximity* metrics. Extra trees have the highest average values for the *plausibility* and *proximity* metrics. This indicates that the extra trees perform better on these metrics. But, it performs lower on the *sparsity* and *validity* metrics. Random forest generally shows moderate performance and has more balanced mean values compared to the other two models. The NICE method has low mean values in the *plausibility* and *proximity* metrics and generally exhibits the lowest performance. However, it performs similarly to other methods for the *sparsity* metric. Examining each quality metric, a particularly low sparsity value may indicate that the changes in the counterfactual samples produced are limited and therefore the changes are meaningful. When we examine the methods considering this situation, the WI method is quite higher than the other two methods.





**Figure 2.** The averages of the quality metrics for the models

Figure 2 shows the results in terms of quality metrics for the models. The proximity metric provides information about how close the counterfactuals produced are to the real data point, the closer they are to this data point, the more valid and reliable results we obtain. Since the values are low when we look at the mean values, this is an advantage for the counterfactuals produced. High plausibility values obtained, which are found in the MOC and NICE methods, produced counterfactuals that can be used in logical situations under real-world conditions. It is observed that the mean values of some methods are zero for some metrics such as *sparsity* and *validity* in the data set. This may suggest that this metric mean may be low because the values obtained are too small. The WhatIf method applied to the models has the same average value for the *plausibility* metric. This metric may be less important for the WhatIf method compared to other methods. Additionally, each average value here is specific to metrics, models, and methods. The results of the analysis help us understand which methods are more successful in which quality metrics. While each quality metric is important in itself, when we look at the results we obtained, the values of proximity in the WI method give much better results, especially in our random forest and extra trees models.

## CONCLUSIONS

This study provides a powerful model that can be used to guide bank managers and regulators in identifying potential risks and developing effective risk management strategies. These results reflect a typical approach to evaluating the performance and effectiveness of a bank failure prediction model. While it focuses specifically on the ability to predict the likelihood of future bank failure for a given period, it also emphasizes providing CEs to enhance the model's ability to understand cause-effect relationships. In conclusion, our study highlights the utility of CEs in enhancing the interpretability and effectiveness of bank failure prediction models. By providing insights into the decision-making process, these explanations empower stakeholders to make informed decisions and implement proactive risk mitigation measures in the financial sector.

## References

Brughmans D., Leyman P., and Martens D., 2023. Nice: an algorithm for nearest instance counterfactual explanations. *Data mining and knowledge discovery*, 1–39.

- Dandl S., Molnar C., Binder M., and Bischl B., 2020. Multi-objective counterfactual explanations. In International Conference on Parallel Problem Solving from Nature, 448–469.
- Wachter S., Mittelstadt B., and Russell C., 2017. Counterfactual explanations without opening the black box: Automated decisions and the GDPR. *Harv. JL & Tech.*, 31: 841 - 847.
- Karimi H., Barthe G., Balle B., and Valera, I., 2020. Model-agnostic counterfactual explanations for consequential decisions. In International conference on artificial intelligence and statistics, 895–905.
- Gunonu S., Altun G., and Cavus, M., 2023. Bank failure prediction models addressing imbalanced data and out-of-time performance, *Proceedings Book of the 7th International Researchers, Statisticians and Young Statisticians Congress, Türkiye, Istanbul*, 185-199.
- Breiman L., 2001. Random forests. *Machine learning*, 45, 5-32.
- Geurts P., Ernst D., and Wehenkel L., 2006. Extremely randomized trees. *Machine learning*, 63, 3-42.
- Kristóf T., and Virág M., 2022. EU-27 bank failure prediction with C5.0 decision trees and deep learning neural networks. *Research in International Business and Finance*, 61, 101644.
- Petropoulos A., Siakoulis V., Stavroulakis E., and Vlachogiannakis N. E., 2020. Predicting bank insolvencies using machine learning techniques. *International Journal of Forecasting*, 36, 1092-1113.
- Molnar, C., 2020. *Interpretable machine learning*. Lulu.com.

#### **Acknowledgment**

The work on this paper is financially supported by the Scientific and Technological Research Council of Türkiye under 2209-A- Research Project Support Programme for Undergraduate Students grant no. 1649B022303919 and Eskişehir Technical University Scientific Research Projects Commission under grant no. 24LÖP006.

#### **Conflict of Interest**

The authors declared that they have no conflict of interest.

#### **Author Contributions**

All authors contributed to the study: Seyma Gunonu contributed to the implementation and results section, Gizem Altun worked on the introduction and methods section, and Mustafa Cavus focused on the research question, design, and framework of the study.

## CQI-8 Level Process Audit (LPA) in a Factory in the Tire Industry

Akın Bahattin Şen<sup>1</sup>, Esra Aktas<sup>2\*</sup>

<sup>1</sup> Karabük University, Department of Industrial Engineering, 78050, Karabük, Türkiye

<sup>2</sup> Gümüşhane University, Department of Occupational Health and Safety, 29100, Gümüşhane, Türkiye

\*Corresponding author e-mail: esra.aktas@gumushane.edu.tr

### Abstract

*The majority of quality errors occur as a result of inadequate processes and controls. Layered Process Audit (LPA) is a popular audit tool in the automotive industry. It is a manual tool that works in conjunction with automotive industry standards like IATF 16949. It is a requirement that typically includes forms. The main reason why LPA is preferred is due to customer's special requests. For these reasons, it is a control mechanism that prevents product recalls, potential reputational damage, and repeat business. LPA auditing is carried out with the participation of all employees in the process rather than individually. In this study, gradual inspection stages were identified to reduce errors in the tire manufacturing process. At these stages, the form was designed so that the answers to the questions were yes or no and took no longer than 5 minutes of the auditor's time.*

**Keywords:** Level Process Audit, LPA, CQI-8, Tire Industry

### INTRODUCTION

CQI-8 Layered Process Audit (LPA) is a widely used quality management tool in the automotive industry and other manufacturing sectors. This method aims to ensure regular and systematic audits of production processes, enhancing their reliability and product quality. (Tague, 2023)

Typically, these audits are conducted at regular intervals by operators or auditors on the production line. They analyze the connections between processes along with the operations of identified products or product groups. These analyses are crucial for identifying potential risks within processes and uncovering opportunities for improvement (Fernandez, n.d.).

The implementation of CQI-8 generally includes the following steps:

1. Audit Planning: Determining which processes will be audited, how frequently, and against which standards. The audit plan defines the scope of processes and audit frequency.
2. Audit Execution: Audits are conducted according to the established plan. Operators or auditors evaluate compliance with defined standards and the accuracy of operations within processes.
3. Evaluation of Results: Audit findings are analyzed, and opportunities for process improvement are identified. If any non-conformances or errors are identified, root cause analysis is conducted, and corrective/preventive action plans are developed.
4. Implementation of Action Plans: Identified action plans are implemented to enhance process quality and take necessary steps to improve operations (Hoyle, 2005).

CQI-8 Layered Process Audit is also aligned with quality management systems such as ISO 9001 and is designed to meet the requirements of these systems. Audits play a critical role in ensuring quality assurance and enhancing customer satisfaction. They are also used to assess supplier performance and ensure quality assurance across the supply chain (AIAG, n.d.).

This method aims to detect errors in processes early and reduce quality costs. By identifying opportunities for improvement in processes, it helps companies enhance operational excellence (Gejdoš, 2015). In conclusion, CQI-8 Layered Process Audit is an indispensable tool for companies seeking continuous quality improvements. It enhances process reliability, reduces operational costs, and maximizes customer satisfaction (International Organization for Standardization, 2015).



Wierzbic and Szewczyk examined layered process audits according to standards. The review revealed the advantages and areas for improvement based on the results of surveys conducted among process managers and auditors (Wierzbic & Szewczyk, 2020). In his research, Kudai demonstrated a real-world audit planning problem in a manufacturing company and discussed the techniques used to solve it, including genetic algorithms, random algorithms, and Greedy algorithms. The study analyzed the problem's modeling for these approaches, their effectiveness, and an explanation of time and space consumption with respect to the LPA method in this article (Wierzbic & Szewczyk, 2020). Hernández and Andrea demonstrated in their study the tools used to understand processes, analyze data, and develop changes that will benefit and add value to process audits, as well as ways to acquire information (Tlapa Hernández, 2014). Automotive companies audited according to ISO 9001:2015, IATF 16949:2016, and CQI-8 LPA derive significant benefits such as securing their processes and identifying opportunities to enhance product quality. In particular, production process audits enable the identification of key points that meet the requirements of processes ensuring quality in products according to the final product customers' requirements (ISO, 2015; IATF, 2022). Järnberg and Samuelsson's study comprehensively examines how LPAs are implemented in manufacturing systems and the benefits these audits bring. It focuses on the effectiveness of LPAs in various manufacturing processes and addresses implementation challenges (Järnberg & Samuelsson, 2022). Raja et al. In their study, evaluate the effectiveness of LPA in quality improvement and emphasize the role of process audits in quality assurance. They analyze improvements brought about by LPA using real-world data (Raja et al., 2023). Lozano et al. In their study, the importance of Layered Process Audits (LPA) for the automotive parts sector in the state of Tlaxcala is discussed. The automotive parts industry in Mexico is one of the most significant economic activities, generating value annually and providing employment and satisfaction at the international level. With new working methods and increasing demands in this sector, companies aim to implement new high-quality business practices to lead globally, reduce costs, and increase efficiency. Statistical data were collected for this study from official sources including ISO 9001:2015, IATF 16949:2016, CQI-8, as well as national and international government organizations such as CITLAX, AMIA, and Agenda Tlaxcala (Lozano et al., 2020).

## **METHODS**

Layered Process Audit (LPA) is a requirement referenced in management system standards for the automotive sector, encompassing complementary methods, conditions, forms, etc. It is cited within standards as a manual and/or method that is indispensable, particularly in the automotive sector (AIAG, n.d.). In this study, ways to prevent errors in the processes of tire manufacturing were investigated. First, layered audit stages were identified. Specific questions were formulated for each identified stage, and the questions were prepared to elicit yes or no answers. The brevity of the question-answer format is designed to save time for the auditor and facilitate easier identification of issues. To identify errors, a team was formed in collaboration with the quality team, and discrepancies in processes were examined based on feedback from customers. As a result of these examinations, processes and control parameters requiring auditing according to customer feedback were identified. First, a tracking form was created based on the identified parameters (Figure 1).

**V. INTERNATIONAL APPLIED STATISTICS CONGRESS (UYİK - 2024)**  
**İstanbul / Türkiye, May 21-23, 2024**

Kademeli Proses Denetim Kontrol Listesi/Layered Process Audit Control Checklist													
Ürün İsmi/Process name: Building			Değerlendirmeye Süzümü: 1. OK olduğu zaman "O"yi girin Lütfen/Evaluation Column: If decision OK please write down "O"										
Ürün Ölçüsü: 5 (10 Makine)			Nö. olduğu zaman "X" girin Lütfen/If decision fail please write down "X"										
Tarih/Dere: 22.08.2022 - 28.08.2022			* Sadece uygulandıgı zaman girilir/You have to fill out only when you audit										
No	Kontrol Maddeleri/Control Items	Uygulayan/Auditor	Sıklık/Frequency	22.08.2022	23.08.2022	24.08.2022	25.08.2022	26.08.2022	27.08.2022	28.08.2022	Uygunluk İlerliği/Nonconformity Content	Alınan Önlemler/Corrective Action Taken	
				Pazartesi	Salı	Çarşamba	Perşembe	Cuma	Cumartesi	Pazar			
1	REBK kauçuklarının üzerine kurmuş tebeğirle REBK tarih-vardiya-saat ve operatör izmi yazılmış mı?	Vardiya amiri	1. vardiya	Karar								İçerik : Sorumlu/Tarih	
			2. vardiya	Karar								İçerik : Sorumlu/Tarih	
			3. vardiya	Karar									İçerik : Sorumlu/Tarih
			* Formen	Haftada 2 kez	Karar								İçerik : Sorumlu/Tarih
			* Şef	Haftada 1 kez	Karar								İçerik : Sorumlu/Tarih
	* Dept. Müdürü												
2	Lot kayıtları zamanında ve doğru şekilde tutulmuş mu? (Topuk, BC ve Basopon ve karışım lotlarının kontrol ediniz)	Vardiya amiri	1. vardiya	Karar								İçerik : Sorumlu/Tarih	
			2. vardiya	Karar								İçerik : Sorumlu/Tarih	
			3. vardiya	Karar								İçerik : Sorumlu/Tarih	
			* Formen	Haftada 2 kez	Karar								İçerik : Sorumlu/Tarih
			* Şef	Haftada 1 kez	Karar								İçerik : Sorumlu/Tarih
	* Dept. Müdürü												
3	Yarım kalan veya ekstrüderden çıkan compoundların üzerine tanımlamaları yapılmış mı?	Vardiya amiri	1. vardiya	Karar								İçerik : Sorumlu/Tarih	
			2. vardiya	Karar								İçerik : Sorumlu/Tarih	
			3. vardiya	Karar								İçerik : Sorumlu/Tarih	
			* Formen	Haftada 2 kez	Karar								İçerik : Sorumlu/Tarih
			* Şef	Haftada 1 kez	Karar								İçerik : Sorumlu/Tarih
	* Dept. Müdürü												

**Figure 1. Tracking Form**

The inspection methods have been decided along with the determined form (Figure 2).

Determined Audit Level and Frequency at Sumitomo Rubber AKO			
Level of supervision	Audit frequency	Auditor	Process
Level 1 Inspection	Every shift (3 shifts)	Shift supervisor	In the process for which he is responsible
Level 2 Inspection	2 times a week	Foreman	In the process for which he is responsible
Level 3 Inspection	1 time per week	Manager and chefs	All production processes

**Figure 2. Supervision Methods**

The supervision of shift supervisors is determined not to exceed 5 minutes (min) at the beginning of each shift. It is ensured that any problems that may arise with their supervision are immediately noted and reported to their superiors so that immediate action can be taken. As can be seen in the supervision table, it has been decided that foremen, who are the immediate supervisors, will carry out their inspections twice a week, while managers and supervisors will carry out their inspections once a week. The time and method for monitoring the identified parameters were determined (Figure 3).

	September	October	November	December	January	February																					
	9.2	9.9	9.16	9.23	10.7	10.14	10.21	10.28	11.4	11.11	11.18	11.25	11.30	12.2	12.9	12.16	12.23	1.6	1.13	1.20	1.27	2.3	2.10	2.17	2.24	2.28	
Creating and publishing documents related to Staged Process auditing																											
Providing training and testing to all shift supervisors																											
Creating a control chart for all production processes																											
Starting the pilot application in the Building Process (All units)																											
Checking the effectiveness of gradual process control and making necessary improvements																											
Creating an audit calendar for 3rd Level (Chief and Managers) auditors																											
Starting to implement gradual process control in all production processes																											
Saving the results and transferring them to the summary table																											
Periodically presenting the results of gradual process auditing to senior management																											

**Figure 3. Time Schedule**

The created calendar (Figure 3) aims to fully implement and apply the LPA audit in the factory within approximately 5.5 months. The calendar outlines step-by-step what needs to be done and allocates specific durations for each stage.

Implementation Stages

In a 3-month period (September, October and November), a total of 5392 questions were inspected in all production processes. Of these, 287 were found to be non-compliant. Figure 4 shows the percentage compliance by months.

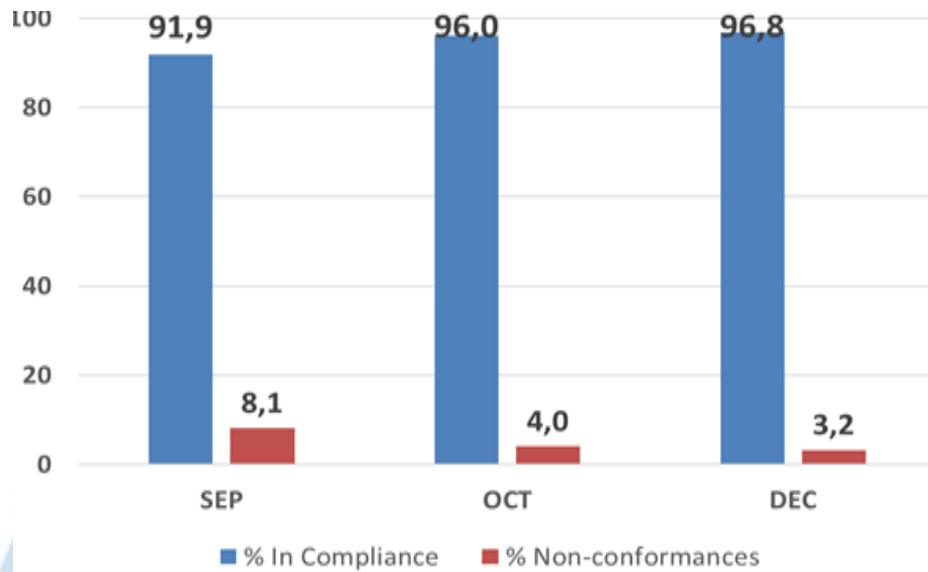


Figure 4. Column Chart of Compliance Percentage

Audits were conducted across all production processes by shift supervisors, foremen, managers, and directors, and non-conformities were identified (Figure 5).

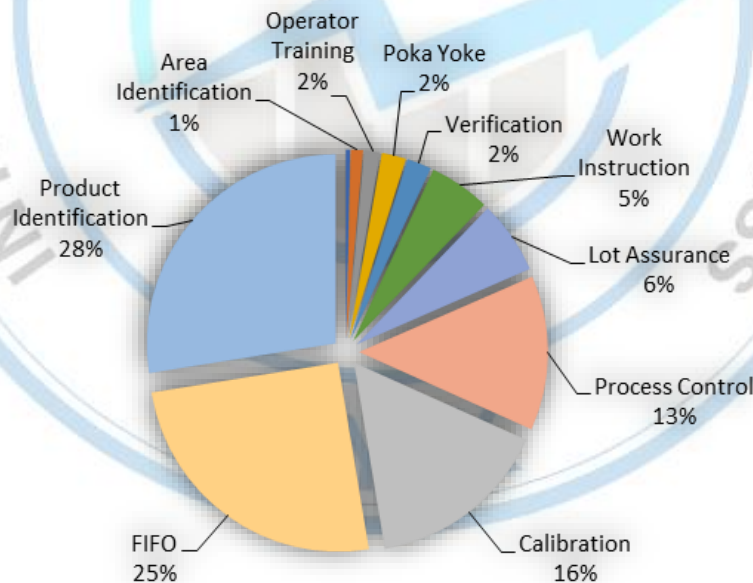
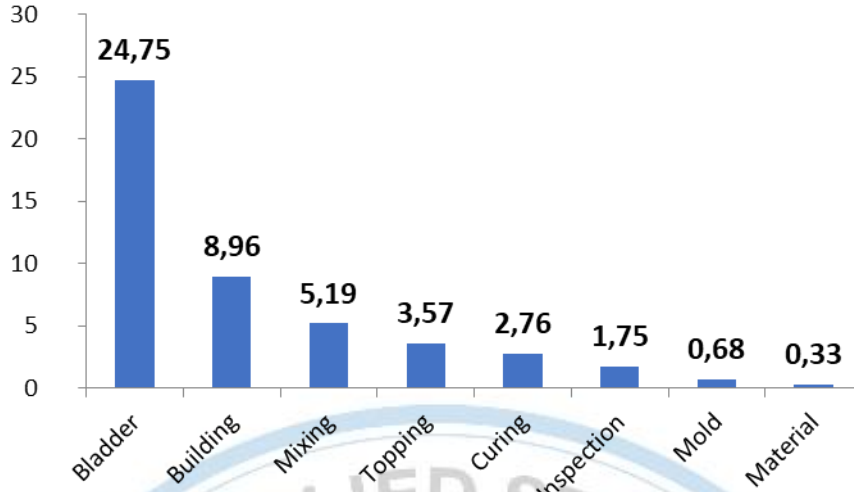


Figure 5. 2022 (September, October, November) Distribution of Nonconformities by Control Items

The pie chart shows the distribution of nonconformities in production processes according to control items. According to this, FIFO, product identification and calibration have the highest share with 69%. Figure 6 shows the percentage nonconformity rates of production processes.



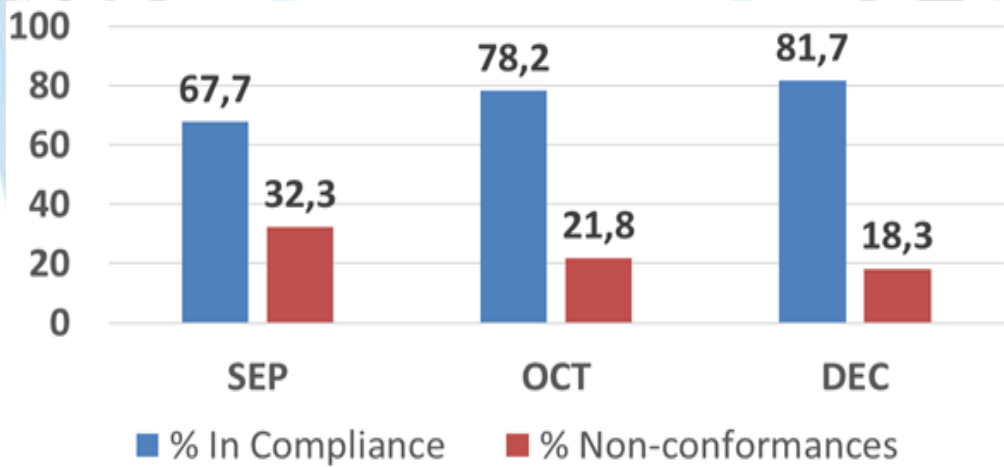


**Figure 6.** Percentage Nonconformity Rates of Production Processes

Nonconformities are evaluated and ranked on a process basis. Based on the analysis and results, detailed analysis will be made for Bladder, Building and Mixing processes respectively.

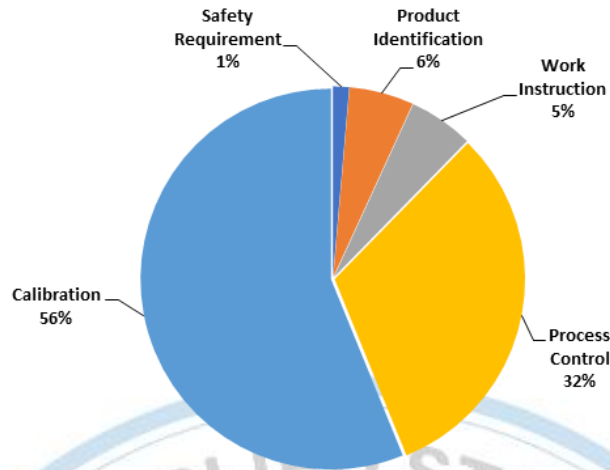
*Bladder Process Analysis*

When the results of the analysis are analyzed, it is seen that Bladder is the process with the highest number of nonconformities with 24.75%. In the 3-month period, nonconformities in the bladder process were analyzed and the results are shown in Figure 7.



**Figure 7.** Bladder Percent Compliance Column Chart

In the 3-month period, nonconformities seen in Figure 8 were realized in the process examined. Thanks to the actions taken by examining these nonconformities on the day, nonconformity rates decreased as seen in Figure 7.

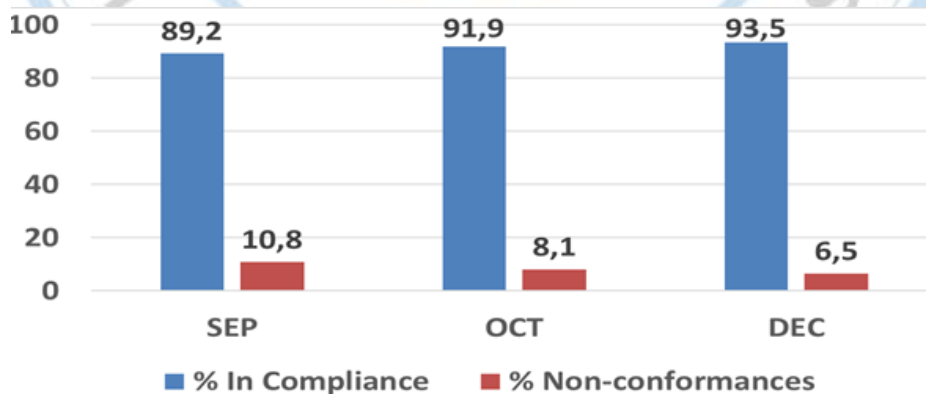


**Figure 8.** Distribution of Nonconformities in Bladder Process According to Control Items

As can be seen in Figure 8 the highest nonconformity rates were observed in the calibration and process control stages. Focusing on the first major nonconformity, calibration, the problem was observed in the drying room where the bladder process was carried out. The nonconformity encountered here was the presence of uncalibrated measurement equipment on site. Two actions were taken to address this. First, the engineering department was informed for the calibration of the equipment, and it was seen that the equipment was only used for failure analysis and there was no need for calibration. The second action taken was to post an informative sign explaining the intended use of the equipment so that production personnel would not use this equipment as a basis for their measurements. In the nonconformity in the process control item, it was determined that the humidity value of the drying room did not comply with the standards. The action taken was to contact the engineering department for the repair of the equipment and to correct it.

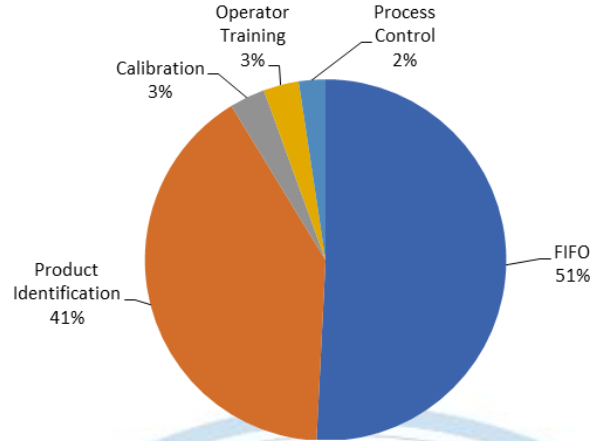
#### *Building Process Analysis*

When the results of the analysis are analyzed, it is seen that Building is the process with the 2nd biggest nonconformity with 8.96%. In the 3-month period, the nonconformities in the building process were analyzed and the results are shown in Figure 9.



**Figure 9.** Building Percentage Compliance Column Chart

In the 3-month period, nonconformities seen in Figure 10 were realized in the process examined. These nonconformities were examined on the day and the actions taken resulted in a decrease in nonconformity rates as shown in Figure 9.



**Figure 10.** Distribution of Nonconformities in the Building Process According to Control Items

As can be seen in Figure 10, the highest nonconformity rates were observed in the FIFO and product identification stages. When the first nonconformity, FIFO control item, is focused on, it is seen that the operators in Building and Curing processes in all units do not apply the kanban system 100%. When the reasons are investigated;

1. The operator thinks that it is not necessary to do this job,
2. Curing operators do not use the token system and randomly pull raw cover carts. For example, they take them from the place closest to the gate,
3. FIFO becomes difficult to implement when there is excess stock. Raw cover carts are left randomly in the stock area,
4. It was determined that sometimes FIFO was not applied consciously.

The actions taken for these identified problems are; Building Excess Stock Management work instruction was created by the unit foreman. It was added to the standard to perform operations according to the order in the document when there is no empty space on the coin board. In addition, the coin board was checked by shift supervisors, foremen and supervisors during the day and operators who did not implement the system were warned and the coin board was corrected.

When the product identification control item, which is the second nonconformity, is examined, the fact that unidentified auger rubber, half compound and small pieces of compound were found on the mixture pallets in the building process constitutes a nonconformity. There is a risk that unidentified incomplete compounds may mix with other compounds and cause quality defects. For this reason, the causes of the issue were first investigated:

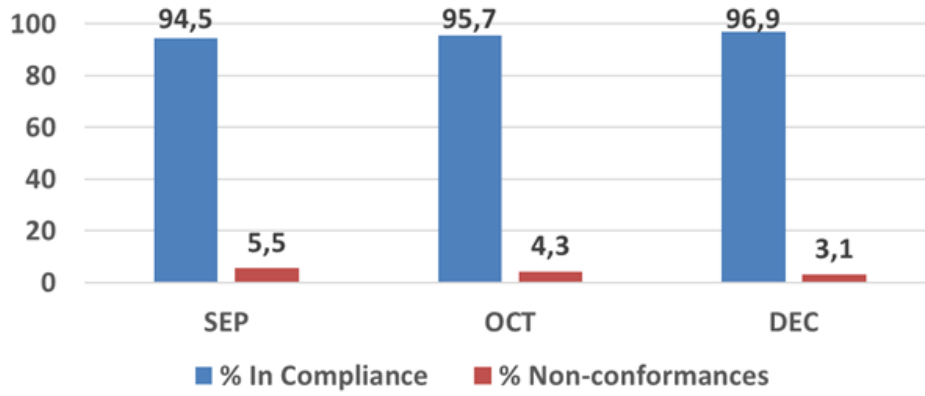
1. The operator does not want to waste time while identifying the compounds and puts the auger compounds on the compound pallet as soon as he takes them out of the extruder and wants to go back to his machine immediately,
2. It was determined that the operators did not have sufficient knowledge about the identification of auger rubber and unfinished rubber.

The actions taken in response to these problems are as follows: training on the identification of leftover material is given by foremen, training records are kept, operators who do not make identification or make incomplete identification are warned in the field and the importance of identification and how to do it is explained.

#### *Mixing Process Analysis*

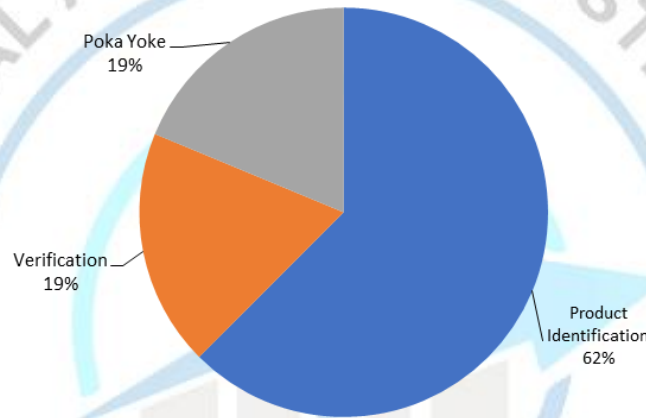
When the results of the analysis are analyzed, Mixing was the process with the 3rd biggest nonconformity with 5.19%. In the 3-month period, the nonconformities in the building process were analyzed and the results are shown in Figure 11.





**Figure 11.** Building Percentage Compliance Column Chart

In the 3-month period, nonconformities seen in Table 8 were realized in the process examined. Thanks to the actions taken by examining these nonconformities on the day, nonconformity rates have decreased as shown in Figure 11.



**Figure 12.** Distribution of Nonconformities in the Building Process According to Control Items

As can be seen in Figure 12, the nonconformities were product identification control item, problems in the Poka-Yoke system and screen error in scale verification. When the first nonconformity, the nonconformity in the product identification control item, was examined, the temporary REBK waiting area definitions were contrary to the definition conditions in the documents. A quick action was taken and the waiting area was reorganized in accordance with the standards. When the second nonconformity, the problems in the Poka Yoke system were examined, a software error was detected in the Poka Yoke system. When an incorrect barcode is scanned during material feeding, the system does not give an error, thus creating the possibility of incorrect loading. The company that installed the machine was contacted and action was taken to solve the problem without cost. When the third nonconformity, the screen error in scale verification, was examined, it was determined that the manual weighing scale screen in the chemical weighing room could not be reset and the weighing screen result could not be written clearly after verification. The action taken was to check the manual weighing scale verification tolerances and necessary corrections were made.

## RESULTS

In the study, a gradual process audit was carried out in the factory serving in the tire industry. In a 3-month period, nonconformities in the processes were examined. In the inspection phase, the frequency and methods of factory inspection were determined first. Then, a follow-up form was created as an audit list with the team formed. Using the created follow-up form, all processes in the factory were examined.

Detailed examinations were carried out in the 3 processes with the highest percentage of nonconformity as a result of the examination. Review results were analyzed on a process basis and actions were taken. On a general basis, it was seen that the nonconformities experienced were due to lack of training and lack of awareness in terms of operators and some calibration deficiencies in terms of machines. In accordance with the logic of the LPA audit, nonconformities that occurred during the 3-month period were intervened immediately on the day. In this way, the number of nonconformities realized during the process decreased. Thanks to the visible improvement in the processes where LPA was applied, the quality rates realized in the processes increased.

### References

- AIAG, n.d. Layered Process Audit Guideline. Automotive Industry Action Group. <https://doi.org/B004Z0WUHC>
- Fernandez E. n.d. CQI-8 Layered Process Audits Guideline. Retrieved May 25, 2024, from [https://www.academia.edu/29895877/CQI\\_8\\_Layered\\_Process\\_Audits\\_Guideline](https://www.academia.edu/29895877/CQI_8_Layered_Process_Audits_Guideline)
- Gejdoš P, 2015. ScienceDirect Continuous Quality Improvement by Statistical Process Control-review under responsibility of the Organizing Committee of BEM2015. *Procedia Economics and Finance*, 34, 565–572. [https://doi.org/10.1016/S2212-5671\(15\)01669-X](https://doi.org/10.1016/S2212-5671(15)01669-X)
- Hoyle D. 2005. *Automotive Quality Systems Handbook: ISO/TS 16949:2002 Edition*. Butterworth-Heinemann. [https://www.amazon.com/Automotive-Quality-Systems-Handbook-16949-ebook/dp/B001CEVJT4/ref=sr\\_1\\_1?crid=2914TBEP1XUU3&dib=eyJ2IjoiMSJ9.tO7JO3EJcg1WJ9yap3yDrnNi2-LAoGG\\_MVnSqsQ0EmRWAX9dwfGTl0xyfTn6OZZZEOT7RA80rUfbrHUr6Pf7jw.BRDAFKubM1otzvd-WZn6ueJey9uy-0XOYP1s](https://www.amazon.com/Automotive-Quality-Systems-Handbook-16949-ebook/dp/B001CEVJT4/ref=sr_1_1?crid=2914TBEP1XUU3&dib=eyJ2IjoiMSJ9.tO7JO3EJcg1WJ9yap3yDrnNi2-LAoGG_MVnSqsQ0EmRWAX9dwfGTl0xyfTn6OZZZEOT7RA80rUfbrHUr6Pf7jw.BRDAFKubM1otzvd-WZn6ueJey9uy-0XOYP1s)
- IATF, 2022. IATF 16949. International Automotive Task Force. [www.iatfglobaloversight.org](http://www.iatfglobaloversight.org)
- International Organization for Standardization. (2015). *ISO 9001:2015, Fifth Edition: Quality management systems - Requirements*. Multiple. Distributed through American National Standards Institute.
- ISO, 2015. *Kalite yönetim sistemleri-Şartlar*.
- Järnberg F, Samuelsson M, 2022. Integration of lean management system into the digitalized factory.
- Lozano, EAN, Aguirre RC, Gutiérrez JLC, Aguirre MAL, 2020. Importance of The Layered Process Audits “LPA’s” For the Sector of Auto parts In the State of Tlaxcala, Mexico.
- Raja DAL, Syafrina M, Saimara Tarigan J, 2023. Effectiveness of Internal Manufacturing Audit on Quality Control Via Layered Process Audit. <https://doi.org/10.4108/eai.7-11-2023.2342299>
- Tague NR, 2023. *The Quality Toolbox (3rd ed.)*. ASQ Quality Press.
- Tlapa Hernández A, 2014. Reingeniería del sistema de las auditorías de procesos por capas LPAs en una empresa automotriz fabricante de columnas de dirección y partes de forja en frío. Benemérita Universidad Autónoma de Puebla.
- Wierzbic A, Szweczyk K. 2020. Digitalization of audit actions in the Industry 4.0 era. *Informatyka Ekonomiczna*, 4: (54), 74–87. <https://doi.org/10.15611/IE.2019.4.06>

### Conflict of Interest

The authors declare no conflict of interest.

### Author Contributions

All authors contributed equally and all authors have read and agreed to the published version of the manuscript.

**Using Multi-Criteria Decision-Making Techniques Determining the Proximity of  
Factories in Ankara to Industry 4.0 Technologies**

**Esra Aktas<sup>1\*</sup>, Akın Bahattin Şen<sup>2</sup>, Ediz Atmaca<sup>3</sup>**

<sup>1</sup>Gümüşhane University, Department of Occupational Health and Safety, 29100, Gümüşhane, Türkiye

<sup>2</sup>Karabük University, Department of Industrial Engineering, 78050, Karabük, Türkiye

<sup>3</sup>Gazi University, Department of Industrial Engineering, 06570, Ankara, Türkiye

\*Corresponding author e-mail: esra.aktas@gumushane.edu.tr

***Abstract***

*The need for a new industrial revolution has grown due to the need for an industrial structure that can work more flexibly, produce more efficiently, and meet higher expectations, in order to replace old production systems that cannot meet consumers' demands for higher quality and personalised products. The fourth industrial revolution, which arose in response to these needs, includes numerous modern automation systems, data exchanges, and manufacturing technologies. Industry 4.0 is a set of values that includes the internet of everything, internet services, and cyberphysical systems. This study was conducted to assess the readiness of Turkey's existing industrial technology infrastructure for the transition to the new industrial revolution. In this regard, a survey was conducted on a sample of factories in Ankara to determine the companies' proximity to the fourth industrial revolution. The survey results were analyzed using multi-criteria decision-making techniques. Based on the findings, a report was created that could serve as an example for Turkey in terms of Industry 4.0 compliance..*

**Keywords:** Industry 4.0, MCDM, AHP, TOPSIS

**INTRODUCTION**

The concept of Industry 4.0 was first introduced at the Hannover Fair in 2011. In addition to traditional production methods, technological advancements have caused production processes to evolve. Prior to the Fourth Industrial Revolution, muscle-powered production began to be mechanized in the late 18th century with the use of mechanical benches. Steel, electricity, and chemicals replaced steam, coal, and iron as the raw materials and energy sources used in production, kicking off the second Industrial Revolution. Since the 1970s, production has taken on a new dimension thanks to advances in digital technology. Living conditions began to improve as a result of the changing socioeconomic and cultural structures brought about by these revolutions. The need for a new industrial revolution has grown due to the need for an industrial structure that can work more flexibly, produce more efficiently, and meet higher expectations, in order to replace old production systems that cannot meet consumers' demands for higher quality and personalised products. The fourth industrial revolution, which arose in response to these needs, includes numerous modern automation systems, data exchanges, and manufacturing technologies. The Internet of Everything encompasses both cyber-physical systems and internet of things. To avoid falling behind in the fourth industrial revolution, as in previous revolutions, a survey was conducted as part of this project to investigate the requirements of the fourth industrial revolution and determine the state of Turkey's industrial infrastructure. In this regard, the criteria were first determined through a literature review, and then a survey was created. The survey study was then weighted using the AHP method, which is a multi-criteria decision-making method. The determined criteria were then analyzed using the TOPSIS method with the ideal factory. Finally, the results were analyzed for each factory, and recommendations were made.



## BACKGROUND AND OBJECTIVES

### Industry 4.0

Industrial revolutions, which have fueled innovation and modernization to this day, occurred in various stages and over long periods of time. Humans have always needed to produce, and new searches have been conducted to ensure that production continues. Regardless of which sector's history is examined, the phenomenon of industrial revolution is always present in their historical development. Prior to the 18th century, agriculture and livestock production accounted for the vast majority of the global economy. In addition, there were tradesmen and craftsmen who worked in fields other than agriculture and livestock. Tradesmen and craftsmen used simple machines or machines that relied on manual labor in their work. A new era in the industry began with the incorporation of water and steam power into production processes. The production structure, which was based on human labor, was transformed into a mechanized one. This mechanization brought about mass production. Large factories were established as a result of the high level of production and diversity. This change altered the global cultural and socioeconomic structure. The society's living standards gradually improved. The world now faced a new future. Cloud computing, the internet of things, big data, simulation, and autonomous robots are examples of cyber-physical systems that are the building blocks of the new industrial revolution (Maresova et al. 2018; Roblek, Meško, and Krapež 2016; Stachová et al. 2020).

### *Multi Criteria Decision Making*

Multi-Criteria Decision Making (MCDM) problems typically arise when choosing between alternatives, ranking, or grouping alternatives. There have been numerous methods developed and applied in the literature for multi-criteria decision making problems (Taherdoost and Madanchian 2023).

### *AHP (Analytic Hierarchy Process)*

AHP was first proposed in the 1970s and is a powerful and easy-to-understand Multi-Criteria Decision Making method that is frequently used in solving complex problems and provides the opportunity to combine objective and subjective factors in the decision-making process. The method is basically a measurement theory based on priorities obtained from pairwise comparison. With AHP, the decision-making problem must be presented in as much detail as possible and the levels called hierarchy must be examined. In the AHP technique, a hierarchical model consisting of a top-level goal and criteria, sub-criteria and options under this goal is used. AHP is based on three basic principles: establishing hierarchies, determining superiorities, and ensuring logical and numerical consistency (Ishizaka and Labib 2011).

AHP is based on the decision maker evaluating all alternatives using all criteria and comparing them pairwise based on their relative importance. Given AHP's hierarchical structure, the decision maker's goal is at the top level. The 1-9 scale developed by Saaty (1980) is widely used for scaling. Experts evaluate using this scale, and all evaluations are combined to create a comparison matrix. Table 1 shows the importance levels used in the scale, along with their definitions and explanations (Ishizaka and Labib 2009).

**Table 1.** Saaty’s Fundamental Scale (Saaty and Vargas 2001)

Intensity of Importance	Definition	Explanation
1	Equal Importance	Two activities contribute equally to the objective
2	Weak	
3	Moderate importance	Experience and judgment slightly favor one activity over another
4	Moderate plus	
5	Strong importance	Experience and judgment strongly favor one activity over another
6	Strong plus	
7	Very strong or demonstrated importance	An activity is favored very strongly over another; its dominance demonstrated in practice
8	Very, very strong	
9	Extreme importance	The evidence favoring one activity over another is of the highest possible order of affirmation

**Step 1:** A binary comparison matrix of size  $n \times n$ , is obtained in the form of  $C_1, C_2, \dots, C_n$  criteria and the evaluation between  $a_{ij}$  criterion and  $C_j$  criterion (on an importance scale of 1-9). In the comparison matrix, the relationship  $a_{ji} = 1/a_{ij}$  and the equality  $a_{ii} = 10$  always exist.

$$A = \begin{matrix} & \begin{matrix} C_1 & C_2 & \dots & C_n \end{matrix} \\ \begin{matrix} C_1 \\ C_2 \\ \vdots \\ C_n \end{matrix} & \begin{bmatrix} 1 & a_{12} & \dots & a_{1n} \\ 1/a_{12} & 1 & \dots & a_{2n} \\ \vdots & \vdots & \ddots & \vdots \\ 1/a_{1n} & 1/a_{2n} & \dots & 1 \end{bmatrix} \end{matrix}$$

**Step 2:** Each element of the comparison matrix is divided by its column total to obtain the normalized comparison matrix.

**Step 3:** Row averages are calculated in each row of the normalized comparison matrix. These mean values express the relative importance of the criteria.

**Step 4:** In order for AHP results to be valid, matrix A must be a consistent matrix. In a consistent matrix A, where  $\sum_{j=1}^n W_j = 1$  is, the weights  $w_i$  (weight vector) are calculated. Weights are the vector obtained by multiplying and summing the relative importance values calculated in Step 3 and the relevant column of the comparison matrix created in Step 1. Consistency coefficient, represented by the consistency index (CI),

$$CI = \frac{\lambda_{\max} - n}{n - 1}$$

calculated from the equation. The  $\lambda_{\max}$  value here is obtained by dividing the weight vector by the relevant relative importance values.

**Step 5:** Consistency rate indicated by CR (Consistency Rate) is calculated with the equation  $CR = CI/RI$ . The random index (RI) varies depending on the value of n (the size of the comparison matrix). The random indicators developed for matrices of size 1-15 are shown in Table 2.

**Table 2.** Random Index

n	1	2	3	4	5	6	7	8	9	10	11	12	13	14	15
<b>RI</b>	0,00	0,00	0,58	0,90	1,21	1,24	1,32	1,41	1,45	1,49	1,51	1,48	1,56	1,57	1,59

If the consistency ratio is equal to 0, it means that a completely consistent matrix has been obtained. However, since it is often not possible to achieve complete consistency in applications, comparisons must be repeated until a consistent matrix is obtained when  $CR \geq 0.1$ .

*TOPSIS (Technique for Order Preference by Similarity to Ideal Solution)*

It was created by Hwang and Yoon (1981) as a multi-criteria decision-making method. Hwang and Yoon developed the TOPSIS method with the idea that the solution alternative is the shortest distance to the positive-ideal solution and the greatest distance to the negative-ideal solution. The TOPSIS method involves generating the decision matrix (A), standard decision matrix (R), weighted standard decision matrix (V), ideal (A\*) and negative ideal (A-) solutions, calculating discrimination criteria, and determining the ideal solution. It consists of steps for calculating relative proximity (Monjezi et al. 2012; Sun 2010; Yu et al. 2018).

**Step 1:** Creating the decision matrix (A)

To begin, create a decision matrix with rows listing preferred alternatives and columns containing evaluation criteria for decision-making. This initial matrix, generated by the decision maker from m alternatives and n evaluation criteria, is shown as follows:

$$A_{ij} = \begin{bmatrix} a_{11} & \dots & a_{1n} \\ \vdots & \ddots & \vdots \\ a_{m1} & \dots & a_{mn} \end{bmatrix}$$

**Step 2:** Creating the Standard Decision Matrix (R)

The initial values in the decision matrix are standardized using the formula below.

$$r_{ij} = \frac{a_{ij}}{\sqrt{\sum_{k=1}^m a_{kj}^2}}$$

As a result of normalizing all the initial values in the decision matrix, the standard decision matrix, denoted by R below, is created.

$$R_{ij} = \begin{bmatrix} r_{11} & \dots & r_{1n} \\ \vdots & \ddots & \vdots \\ r_{m1} & \dots & r_{mn} \end{bmatrix}$$

**Step 3:** Creating the Weighted Standard Decision Matrix (V)

First, the weight ratios ( $w_i$ ) of the evaluation criteria are determined.

$$\sum_{i=1}^n w_i = 1$$

Afterwards, each value in the R matrix is multiplied by the ( $w_i$ ) value of the criterion to which it depends, creating the Weighted Standard Decision Matrix (V).



$$V_{ij} = \begin{bmatrix} w_1 r_{11} & \dots & w_n r_{1n} \\ \vdots & \ddots & \vdots \\ w_1 r_{m1} & \dots & w_n r_{mn} \end{bmatrix}$$

**Step 4:** Creating Ideal ( $A^*$ ) and Negative Ideal ( $A^-$ ) Solutions

The TOPSIS method assumes that each evaluation criterion shows a monotonically increasing or decreasing trend. Therefore, the maximum value in each column of the V matrix represents the Ideal ( $A^*$ ) solution, and the minimum value represents the Negative Ideal ( $A^-$ ) solution.

$$A^* = \left\{ (\max_i v_{ij} \mid j \in J), (\min_i v_{ij} \mid j \in J') \right\}$$

The set to be calculated from the formula given above can be shown as  $A^* = \{v_1^*, v_2^*, \dots, v_n^*\}$ .

$$A^- = \left\{ (\min_i v_{ij} \mid j \in J), (\max_i v_{ij} \mid j \in J') \right\}$$

The set to be calculated from the formula given above can be shown as  $A^- = \{v_1^-, v_2^-, \dots, v_n^-\}$ .

**Step 5:** Calculation of Discrimination Criteria

Euclidian Distance Approach is used to calculate the distance of the criterion value of each decision point to the ideal and negative ideal solution points. Accordingly, the distance of each alternative from the ideal solution to the ideal separation ( $S_i^*$ ) and the distance from the negative ideal solution to the negative ideal separation ( $S_i^-$ ) criteria are calculated with the following formulas.

$$S_i^* = \sqrt{\sum_{j=1}^n (v_{ij} - v_j^*)^2} \quad S_i^- = \sqrt{\sum_{j=1}^n (v_{ij} - v_j^-)^2}$$

**Step 6:** Calculation of Relative Closeness to the Ideal Solution

Using ideal and negative ideal discrimination criteria, the relative closeness ( $C_i^*$ ) of each alternative to the ideal solution is calculated. The share of the negative ideal discrimination criterion calculated for each alternative in the total discrimination criterion shows the ( $C_i^*$ ) value of the relevant alternative.

It is in the range  $0 \leq C_i^* \leq 1$  and alternatives are ranked according to  $C_i^*$  value.

$$C_i^* = \frac{S_i^-}{S_i^- + S_i^*}$$

**MATERIAL AND METHODS**

With the advancement of technology, the world's industry is entering a new era of revolution. This new industrial revolution necessitates a significant technological infrastructure. When we look at the Turkish industry as a whole, it is believed that a large portion of it lacks the infrastructure required to use advanced technology and is not even prepared to build it. As a result, it emerged as the Turkish industry in order to keep up with the times, meet its needs, and ensure the economy's long-term viability.

To determine the level of technology used in the systems by analyzing the existing production and service systems of the factories located in Ankara Industrial Zones using special survey studies, to modernize the existing systems by examining the adequacy of the technological infrastructure of the factories in the region, and to investigate the feasibility of new production and service systems offered by technology developing with the fourth Industrial Revolution. It aims to make appropriate recommendations for the future and contribute to regional development as a result of the improvements implemented.

The purpose of the study was to determine the proximity of factories in various sectors in Ankara to industry 4.0 technologies. In this context, the technologies that will serve as the foundation for industry 4.0 were first identified. The benefits of these technologies were assessed using the AHP method, one of the multi-criteria decision-making techniques, with the assistance of two experts. The survey scoring system was then created using the criteria weights that had been determined. With the assistance of experts in the field of factories determined in the sector, surveys were administered to the factories, and scores were generated. The obtained scores were then analyzed using TOPSIS. The ideal factory's scoring system is based on the weights obtained using the AHP method.

#### Survey and Data Collection

To prepare the survey, analysis techniques were researched, and open, closed, and multiple choice question types were created based on the question. It has been determined as 9 different headings, including ERP, robots, material handling, prototype product design and production, sensors, cloud computing, cyber security, quality control activities, and others (descriptive questions), which are also components of Industry 4.0. 28 questions have been prepared on the determined topics. The prepared survey was collected by observing factories with the assistance of an expert, as well as sending an online survey created on Google Forms to factories where administrative permission could not be obtained.

#### AHP-TOPSIS

Criteria were determined based on the topics of the prepared survey questions. The criteria were classified into eight categories: ERP, robots, material handling, prototype product design and production, sensors, cloud computing, cyber security, quality control activities, and others. To weight these criteria, a Pairwise Comparison Table was created using the Criteria's Importance Scale. Two expert opinions were weighted. Pairwise Comparison table according to the Importance Scale of Criteria is given in Table 3.

**Tablo 3.** Pairwise Comparison Matrix

	ERP	Robots	Material Handling	Prototype	Sensors	Cloud computing	Cyber Security	Quality Control
ERP	1	4,5	7	6,5	3,5	2	1,5	2
Robots	0,22222	1	3,5	2,5	0,25	2,5	0,333333	1
Material Handling	0,14286	0,2857	1	2	0,333333	1	0,5	0,333333
Prototype	0,15385	0,4	0,5	1	0,22222	0,3333333	0,333333	0,333333
Sensors	0,28571	4	3	4,5	1	3	2	1,5
Cloud Computing	0,5	0,4	1	3	0,33333	1	1	0,666667
Cyber Security	0,66667	3	2	3	0,5	1	1	0,666667
Quality Control	0,5	1	3	3	0,666667	1,5	1,5	1

By normalizing the pairwise comparison matrix, the Criteria Normalized Matrix was obtained. After the criteria were normalized, the relative importance vector ( $W_i$ ) was found. In order to calculate the CR value required to calculate the consistency of the comparisons, the largest eigenvector ( $\lambda_{\max}$ ) value of the pairwise comparison matrix was first calculated.

$$\lambda_{\max} = \frac{69,07088989}{8} = 8,633861236$$

Then, the Random Index (RI) depending on the number of factors (n) included in the comparison was found. Since the number of factors was 8, it was observed that the Random Index was 1.41. The CR

**V. INTERNATIONAL APPLIED STATISTICS CONGRESS (UYİK - 2024)**  
**İstanbul / Türkiye, May 21-23, 2024**

value was calculated based on the inputs obtained as 0,064220997. Since the CR value found was less than 0.10, the pairwise comparison matrix was found to be consistent. The weighting of the survey as a result of the AHP is shown in table 4. These values also show the values of the ideal factory created.

**Table 4.** Final Weights for Criteria

Criteria	Final Weights for Criteria
ERP	26
Robots	3
Material Handling	8,6
Prototype	4,4
Sensors	17
Cloud Computing	7
Cyber Security	10
Quality Control	10
Others	14

The total scores of the companies to which the survey was conducted from the criteria weighted according to the survey answers were determined. The values obtained by the 15 examined companies, ideal factory and negative ideal factory are shown in Table 5.

**Table 5.** Values that companies receive from surveys

	ERP	Robots	Material Handling	Prototype	Sensors	Cloud computing	Cyber Security	Quality Control	Others
Factory 1	18,5	2	0	2,2	5,8	4	1	0,2	6
Factory 2	19,5	0,8	6,3	0,4	3	4,5	3	0,2	3,3
Factory 3	21,5	1,2	8,6	0,4	11,6	4,5	2	10	1,7
Factory 4	15,5	1,8	2,3	0,4	17	5	2	4	5
Factory 5	19	0,8	7,3	0,2	4	1,5	2	0,2	3,4
Factory 6	23	1	0	0,1	7,6	6	10	10	2,7
Factory 7	0	0	0	0,2	1	1	1	0,1	0,2
Factory 8	17	0,2	0	0,2	4	5	9	0,2	1,8
Factory 9	10	0	2,3	0,2	1,5	1	0	0,2	0,5
Factory 10	14,5	0,2	3,6	0,3	9,8	1	9	10	1,7
Factory 11	11,5	0,8	7,3	2,4	12	5	10	3,9	7
Factory 12	19,5	1	2,3	0,4	9,8	1	9	4	3,8
Factory 13	21,5	0	0	0,4	7,1	1	2	4	1,5
Factory 14	7,5	0	7,3	0,2	2,8	1	9	0,1	1,4
Factory 15	9	0,8	7,3	0,2	5,8	2	3	0,2	3,3
Negative Ideal Factory	0	0	0	0	0	0	0	0	0
Ideal Factory	26	3	8,6	4,4	17	7	10	10	14

After the weighting study, the TOPSIS method was applied to calculate the relative closeness of the alternatives to the ideal company. Table 6, Table 7 and Table 8 show the TOPSIS steps and the results of the steps.



**V. INTERNATIONAL APPLIED STATISTICS CONGRESS (UYIK - 2024)**  
**İstanbul / Türkiye, May 21-23, 2024**

**Table 6.** Obtaining Ideal and Negative Ideal Solution Values

<b>Ideal Solutions</b>	0,988 894	0,19 01	0,35 844	0,35015 8956	0,799 654	0,32242 8668	0,42530 8574	0,497 734	0,899 584
<b>Negative Ideal Solution</b>	0	0	0	0,00795 8158	0,047 038	0,04606 1238	0	0,004 977	0,012 851

**Table 7.** Obtaining Distance Values to Ideal and Negative Ideal

	$S_i^*$	$S_i^-$
<b>Factory 1</b>	3,187422	2,0506
<b>Factory 2</b>	3,866656	1,9668
<b>Factory 3</b>	2,625849	3,237
<b>Factory 4</b>	2,374202	2,9809
<b>Factory 5</b>	3,922047	1,8951
<b>Factory 6</b>	2,709201	3,714
<b>Factory 7</b>	8,252341	0,0053
<b>Factory 8</b>	4,372014	1,7233
<b>Factory 9</b>	6,348084	0,4346
<b>Factory 10</b>	3,22124	2,4157
<b>Factory 11</b>	1,917364	2,7576
<b>Factory 12</b>	2,582546	2,6426
<b>Factory 13</b>	3,873691	2,2304
<b>Factory 14</b>	5,559161	0,9033
<b>Factory 15</b>	4,512186	0,8661
<b>Ideal Factory</b>	0	8,3567

**Table 8.** Calculation of Relative Closeness to the Ideal Solution

	$C_i^*$
<b>Ideal Factory</b>	1
<b>Factory 11</b>	0,58987
<b>Factory 6</b>	0,57822
<b>Factory 4</b>	0,55665
<b>Factory 3</b>	0,55212
<b>Factory 12</b>	0,50575
<b>Factory 10</b>	0,42855
<b>Factory 1</b>	0,39148
<b>Factory 13</b>	0,36539
<b>Factory 2</b>	0,33716
<b>Factory 5</b>	0,32578
<b>Factory 8</b>	0,28273
<b>Factory 15</b>	0,16104
<b>Factory 14</b>	0,13978
<b>Factory 9</b>	0,06408
<b>Factory 7</b>	0,00064

As a result of the calculations, the largest  $C_i^*$  value belonged to Factory 11 and was found to be 0.58987, and the smallest  $C_i^*$  value belonged to Factory 7 and was found to be 0.00064.

## RESULTS

To get close to the ideal factory, Factory 11 must prioritize the development of its ERP and quality control processes, Factory 6 must prioritize the development of material handling systems and robot technologies, Factory 4 must prioritize the development of cyber security and robotic Technologies, Factory 3's cyber security and material handling systems must be prioritized, Factory 12 must prioritize the development of robotic technologies, cloud computing technologies, and the quality control process. ERP, prototype production, material handling systems, and cloud technologies must all be developed before Factory 10 can be considered an ideal factory. To bring Factory 1 closer to the ideal factory, robotic technologies, cyber security, and quality control processes must be developed, Factory 13 must develop prototype production, robotic technologies, material handling systems, cloud computing technologies, and cyber security. To bring Factory 2 closer to the ideal factory, the material handling system, sensor technologies, cyber security, and quality control processes must be improved, Factory 5 must prioritize prototyping, material handling systems, sensor technologies, and quality control processes. To bring Factory 8 closer to the ideal factory, prototype production, robotic technologies, material handling systems, sensor technologies, and quality control processes must be developed. Factory 15, Factory 14, Factory 9, and Factory 7 companies must be developed for all criteria.

**Table 9.** Factories and their proximity to the Ideal Factory

	ERP	Robots	Material Handling	Prototype	Sensors	Cloud computing	Cyber Security	Quality Control	Others
<b>Factory 11</b>	11,5	0,8	7,3	2,4	12	5	10	3,9	7
<b>Factory 6</b>	23	1	0	0,1	7,6	6	10	10	2,7
<b>Factory 4</b>	15,5	1,8	2,3	0,4	17	5	2	4	5
<b>Factory 3</b>	21,5	1,2	8,6	0,4	11,6	4,5	2	10	1,7
<b>Factory 12</b>	19,5	1	2,3	0,4	9,8	1	9	4	3,8
<b>Factory 10</b>	14,5	0,2	3,6	0,3	9,8	1	9	10	1,7
<b>Factory 1</b>	18,5	2	0	2,2	5,8	4	1	0,2	6
<b>Factory 13</b>	21,5	0	0	0,4	7,1	1	2	4	1,5
<b>Factory 2</b>	19,5	0,8	6,3	0,4	3	4,5	3	0,2	3,3
<b>Factory 5</b>	19	0,8	7,3	0,2	4	1,5	2	0,2	3,4
<b>Factory 8</b>	17	0,2	0	0,2	4	5	9	0,2	1,8
<b>Factory 15</b>	9	0,8	7,3	0,2	5,8	2	3	0,2	3,3
<b>Factory 14</b>	7,5	0	7,3	0,2	2,8	1	9	0,1	1,4
<b>Factory 9</b>	10	0	2,3	0,2	1,5	1	0	0,2	0,5
<b>Factory 7</b>	0	0	0	0,2	1	1	1	0,1	0,2
<b>Ideal Factory</b>	26	3	8,6	4,4	17	7	10	10	14

## DISCUSSION AND CONCLUSION

Within the scope of the study, a survey was developed to assess factories' proximity to Industry 4. The prepared survey was administered to a sample of factories in Ankara. The survey study identified criteria such as ERP, robot technologies, material handling systems, prototype production, sensor technology, cloud computing, cyber security, and quality control activities. Expert opinions on the determined criteria were collected to create a pairwise comparison matrix. The pairwise comparison matrix was used to apply AHP, and the opinions were found to be consistent, as were the weights of the criteria.

Following the weighting analysis, the TOPSIS method was used to calculate the relative closeness of the alternatives to the ideal solution. For all evaluations, Factory 11 was found to be the closest factory to the ideal factory, while Factory 7 was found to be the furthest. A comparison was made between the factories in terms of each criterion, using the weight values obtained as a result of the AHP of the alternative factories. Finally, the results for each factory were evaluated separately and suggestions were made to increase the proximity of the factories to the ideal factory.

### References

- Ishizaka A, Ashraf L, 2009. Analytic Hierarchy Process and Expert Choice: Benefits and Limitations. *OR Insight*, 22 (4): 201–20. <http://link.springer.com/10.1057/ori.2009.10>.
- Ishizaka A, Ashraf L, 2011. Review of the Main Developments in the Analytic Hierarchy Process. *Expert Systems with Applications*. <https://linkinghub.elsevier.com/retrieve/pii/S0957417411006701>.
- Maresova P, Soukal I, Svobodova L, Hedvicakova M, Javanmardi E, Selamat A, 2018. Consequences of Industry 4.0 in Business and Economics. *Economies* 6 (3): 46. <https://www.mdpi.com/2227-7099/6/3/46>.
- Monjezi M, Dehghani H, Singh TN, Sayadi AR, Gholinejad A, 2012. Application of TOPSIS Method for Selecting the Most Appropriate Blast Design. *Arabian Journal of Geosciences* 5 (1): 95–101.
- Roblek V, Maja M, Alojz K, 2016. A Complex View of Industry 4.0. *SAGE Open* 6 (2): 215824401665398. <http://journals.sagepub.com/doi/10.1177/2158244016653987>.
- Saaty TL, Luis GV, 2001. *Models, Methods, Concepts & Applications of the Analytic Hierarchy Process*. Boston, MA: Springer US. <http://link.springer.com/10.1007/978-1-4615-1665-1>.
- Stachová, K, Zdenko S, Dagmar C, Augustín S, 2020. Use of Digital Technologies for Intensifying Knowledge Sharing. *Applied Sciences* 10 (12): 4281. <https://www.mdpi.com/2076-3417/10/12/4281>.
- Sun, C, 2010. A Performance Evaluation Model by Integrating Fuzzy AHP and Fuzzy TOPSIS Methods. *Expert Systems with Applications* 37 (12): 7745–54. <https://linkinghub.elsevier.com/retrieve/pii/S0957417410003660>.
- Taherdoost H, and Mitra M, 2023. Multi-Criteria Decision Making (MCDM) Methods and Concepts. *Encyclopedia* 3 (1): 77–87. <https://www.mdpi.com/2673-8392/3/1/6>.
- Yu L, Wenhua Y, Yunlong D, Xinwen L, 2018. A Study on the Application of Coordinated TOPSIS in Evaluation of Robotics Academic Journals. *Mathematical Problems in Engineering* 2018: 1–7. <https://www.hindawi.com/journals/mpe/2018/5456064/>.

### Conflict of Interest

The authors declare no conflict of interest.

### Author Contributions

All authors contributed equally and all authors have read and agreed to the published version of the manuscript.



## Investigation of Statistical Parameters of a Set of Pseudo-Random Numbers Generated by Various Methods

M.R.Alizada<sup>1</sup>, R.A.Alizade<sup>2</sup>

<sup>1</sup>Department of Theoretical Physics, Baku State University, Azerbaijan, Baku Az-1148, str. Z.Khalilov, 23

<sup>2</sup>Institute of Physics, Ministry of Science and Education of the Azerbaijan Republic, Azerbaijan, Baku Az-1143, H.Javid 33

\*Corresponding author e-mail: [alizaderasim2017@gmail.com](mailto:alizaderasim2017@gmail.com)

### Abstract

*Dependencies of statistical parameters: mean value, dispersity, coefficient of asymmetry, excess, number with identical value of the set of pseudo-random numbers generated various method on the number of their are determined. Has been shown, that with a large number of random numbers, the statistical parameters of the random numbers set converge to a stable value.*

**Key words:** A Pseudo-Random Number, Mean Value, Dispersity, Coefficient of Asymmetry, Excess, Number of Pseudo-Random Number with Identical Value of the Set of Pseudo-Random Numbers

### INTRODUCTION

Computer programs that, based on the Monte Carlo (MC) method are very widely applied in different areas of science and technology. There are used in the mathematics: differentiation and integration of one-, multi variable functions, solution of differential and integral equations, and etc., in the physics: by many theorists who use them to predict experiments and develop methods proposed for experiments, by experimenters in the analysis of the results obtained (Landau D.P., Binder K., 2015; Gould H., Tobochnik J. et al., 2016; Yinghong Z., Jianguo W. 2012; and ZhiMin, Hong, ZaiZai, Yan et al., 2012).

Simulating with random numbers, you can refine the process parameters for qualitative and quantitative agreement of the intended model with the real physical process and create a more accurate physical process model (Sjostrand T., 2016; Buckley A., Butterworth J. et.al , 2016; Sheikh-Bagheria D., Rogers D.W.O., 2002).

At present pseudo-random numbers are obtained by various methods: the middle square, the linear congruent method and its various modifications (Knuth DE., 1998; Forsythe GE., Malcolm MA. et al., 1977; Gould H., Tobochnik J. et al., 2016), as well as in many algorithmic languages C++ (<https://www.programiz.com/cpp-programming/online-compiler>), Fortran 77 (<https://onecompiler.com/fortran/3xsau3ceu>), Python-3.12.-0 and in computer systems Excell, Mathematica-10, Maple-15, MathCad, MathLab-7.5.0.342(R2007b), added generators as a module pseudo-random numbers.

The method of generating pseudo-random numbers can be considered effective if a small number of generated pseudo-random numbers with great accuracy can determine characteristics and simulate the process in question and also spend the least amount of machine time.

The reliability of the results obtained when using a set of random numbers depends on the statistical characteristics of the set. At present there are many statistical (empirical and theoretical) methods testing set of pseudo-random numbers (James F., Moneta L. 2020; Rukhin A., Soto J. et al., 2010; Ryabko B., 2022; Kang M., 2005). Most of them are based in a comparison between observed and expected frequencies.  $\chi^2$ , Kolmogorov-Smirnov, frequency (uniformity or equidistribution), seriality (k-dimensionality, homogeneity), poker (separation), gap (runs above and below the median), runs up and down, extreme values (maximum k), coupon collection, permutation tests, etc. are commonly used in

testing (James F., Moneta L. 2020; Rukhin A., Soto J. et al., 2010; Ryabko B., 2022; Kang M., 2005). Theoretical tests used on theoretical properties of the generators that maybe deduced without a sample sequence.

The efficiency of programs based on pseudo-random numbers largely depends on converge of the parameters of the set of generated pseudo-random numbers: average, standard deviation, asymmetry coefficients, polydispersity and correlation, repeatability and period to a there stable value.

In the presented article we investigated statistical parameters: the mean value ( $\overline{x^n}$ ), standard deviation ( $\sigma$ ), standard error ( $x_m$ ),  $n$ -th central moment of the distribution ( $\mu_n$ ), coefficient of asymmetry ( $\eta_n$ ), excess ( $\varepsilon$ ), coefficient of polydispersity ( $p_k$ ), coefficient of correlation ( $K$ ),  $\chi^2$  criterion, period ( $T_N$ ) and the number of identical pseudo-random numbers ( $N_{ID}$ ) of set of pseudo-random numbers. Dependence of converges of value of statistical parameters to stabel value on number of pseudo numbers in set investigated.

## MAIN STATISTICAL PARAMETERS OF SET OF PSEUDO-RANDOM NUMBERS

### Methods of generating of pseudo-random numbers

Set of pseudo-random numbers generated programs based on the, average square, linear congruent method, IEOR, PRIME, Urand (Sjostrand T., 2016; Buckley A., Butterworth J., et.al , 2016; Sheikh-Bagheria D., Rogers D.W.O., 2002; Knuth DE., 1998), and by random number generators in the Mathematica-10, Mapple-15, Matlab-R2007b, Mathcad-14, Python-3.12.-0, Excel-2010, Visual Fortran -6.6, C++(<https://www.programiz.com/cpp-programming/online-compiler>), Fortran-77 (<https://onecompiler.com/fortran/3xsau3ceu>) and other. Random numbers were obtained in the amount of 50, 100, 200, 300, 500, 700, 1000, 2000, 3000, 5000, 7000 and 10000 has been investigated.

### Main statistical parameters of set of pseudo-random numbers

The main statistical parameters of a set of pseudo-random numbers: the mean value ( $\overline{x^n}$ ), standard deviation ( $\sigma$ ), standard error ( $x_m$ ),  $n$ -th central moment of the distribution ( $\mu_n$ ), coefficient of asymmetry ( $\eta_n$ ), excess ( $\varepsilon$ ), coefficient of polydispersity ( $p_k$ ), coefficient of correlation ( $K$ ),  $\chi^2$  criterion and the number of identical pseudo-random numbers ( $N_{ID}$ ) has been determined as in (Forsythe GE., Malcolm MA. et al., 1977; Kang M., 2005; Hudson D.J. , 1974):

$$\overline{x^m} = \frac{\sum_{i=1}^n x_i^m}{n}, \quad \sigma = \left( \frac{\sum_{i=1}^n (x_i - \overline{x})^2}{n} \right)^{1/2}, \quad x_m = \frac{\sigma}{\sqrt{n-1}}, \quad \mu_n = \overline{(x - \overline{x})^n}, \quad \eta = \frac{\mu_3}{\sigma^3}, \quad \varepsilon = \frac{\mu_4}{\sigma^4} - 3,$$

$$K = \frac{n \sum_{i=1}^n x_i y_i + \sum_{i=1}^n x_i \sum_{i=1}^n y_i}{\sqrt{\left( n \sum_{i=1}^n x_i^2 - \left( \sum_{i=1}^n x_i \right)^2 \right) \left( n \sum_{i=1}^n y_i^2 - \left( \sum_{i=1}^n y_i \right)^2 \right)}}$$

where  $x_i$  and  $y_i$  sequences of random numbers.

$$\mu_n = -\frac{1}{n-1}, \quad \sigma_n = \frac{n^2}{(n-1)^2(n-2)}$$

A good value is considered when the correlation coefficient is between  $\mu_n - 2\sigma_n$  and  $\mu_n + 2\sigma_n$  (Knuth DE., 1998).

It is know set of pseudo-random numbers must be narrow distribution: small value of the average quadratic deviation ( $\sigma$ ), coefficient asymmetry ( $\eta_n$ ), coefficient of correlation near 0, and coefficient

polydispersity  $p_k < 1.101$  (Irani RR. and Calls CF. 1963).

The distribution function of the number of random numbers from their value, the quantity for a discrete and for a continuous random variable, was determined by the formula:  $F(x) = P(X < x)$ , where  $P(X < x)$  is the probability that the random variable  $X$  will take a value less than the variable  $x$ , which “runs through” all real values (from “minus” to “plus” infinity) (Buckley A., Butterworth J. et.al, 2016; Knuth DE., 1998).

Histograms were constructed by method described in (Ali-zade RA., 2008).

One of the main parameters of pseudo-random numbers is their uniform distribution. This basically it determines the effectiveness of using pseudo-random numbers. The uniform distribution of set of random-number must be following propertie:

$$N(\Delta x_i) = N(\Delta x_j), \quad N(n\Delta x_i) = n N(\Delta x_i), \quad i, j = 1, 2, \dots, n$$

where  $N(\Delta x)$ - number of pseudo-random numbers in the interval  $\Delta x$ .

The uniformity of the distribution of pseudo-random numbers was determined as follows. The pseudo-random number change interval  $[0, 1]$  was changed to  $[x_{max} - x_{min}]$  and the change step was chosen  $x_{step}$ . Then the number of subintervals will be determined as  $n = (x_{max} - x_{min}) / x_{step}$  and the average number of pseudo-random numbers falling within one interval will be equal to  $N(\Delta x) = N/n$ , where  $N$  is the number of generated pseudo-random numbers. For simple calculations we took  $x_{min} = 0$ ,  $x_{max} = 10$  and  $x_{step} = 0.5$ , consequently obtain  $n = 20$ . The average number of pseudo-random numbers in a sub-interval should be equal to 2.5, 5, 10, 15, 20, 35, 50, 100, 150, 200, 250, 350 and 500 with the generated number of pseudo-numbers 50, 100, 200, 300, 500, 700, 1000, 2000, 3000, 5000, 7000, 10000 the number of pseudo numbers falling into the interval. Value of pseudo-random number is determined as  $x = x_{min} + rnd \cdot (x_{max} - x_{min})$ , and number of pseudo-random number falled in the sub-interval  $[x_{min} \cdot i, x_{min} \cdot (i+1)]$ ,  $i = 1, \dots, n$  is determined from condition  $x_{min} \cdot i \leq x \leq x_{min} \cdot (i+1)$ .

The number of pseudo-random numbers with the maximum deviation from the average  $\Delta_{max}$  and the ratio  $\Delta_{max} / N(\Delta x)$  are determined.

Statistical analysis of the set of pdeud random numbers was carried out after removing numbers with the same values from the set of random numbers using a program written in the algorithmic language Fortran.

## DETERMINATION OF MAIN STATISTICAL PARAMETERS OF THE SET OF PSEUDO-RANDOM NUMBERS

Before statistical analysis and application of random numbers, duplicate numbers were removed from the set [21].

Statistical analysis of pseudo-random numbers generated by generated programs based on the, average square, linear congruent method, IEOR, XOR, PRIME, Urand, and by random number generators in the Mathematica-10, Mapple-15, Matlab-R2007b, Mathcad-14, Python-3.12.-0, Excel-2010, Visual Fortran -6.6, C++, Fortran-77 has been carried out.

Based on the results of statistical analysis set of pseudo-random numbers the dependence of the parameters of the set of pseudo-random numbers on the number of pseudo-random numbers was investigated. Analysis showed that despite different methods of obtaining pseudo-random numbers for all generated pseudo-random numbers, there are similar dependencies  $\bar{x} = \bar{x}(N)$ ,  $\sigma = \sigma(N)$ ,  $\mu = \mu(N)$ ,  $\varepsilon = \varepsilon(N)$ ,  $p_k = p_k(N)$ . They differ only with the minimum number of pseudo-random numbers generated at which statistical parameters of set of pseudo-random numbers converge to their stable value.

$$\lim_{N \rightarrow N_{min}} \bar{x}(N) = x_0, \quad \lim_{N \rightarrow N_{min}} \sigma(N) = \sigma_0, \quad \lim_{N \rightarrow N_{min}} \mu(N) = \mu_0, \quad \lim_{N \rightarrow N_{min}} \varepsilon(N) = \varepsilon_0, ,$$

$$\lim_{N \rightarrow N_{min}} p_k(N) = p_{k_0}$$

Analysisi of statistical parameters of set of random number generated by various method show that



converge to their stable value at big number pseudo-random number. Statistical parameters of set of pseudo-random number generated by C++ and Fortran compiler converge to their stable value at  $N=7000$ , 1100 correspondingly. For all investigated set of random number generator various method the dependence of  $\sigma=\sigma(N)$  monotonously decrease with increasing of number pseudo-random number  $N$  in set. Dependences  $\bar{x}=\bar{x}(N)$ ,  $\eta=\eta(N)$  and  $\varepsilon=\varepsilon(N)$  fluctuate around a stable value and, decreasing the amplitude of the difference, approach a stable value.

Fig.1(a,b) shows the dependencies of the mean value and the standard deviation of the set of pseudo-random numbers generated by the Fortran compiler on the number of pseudo-random numbers.

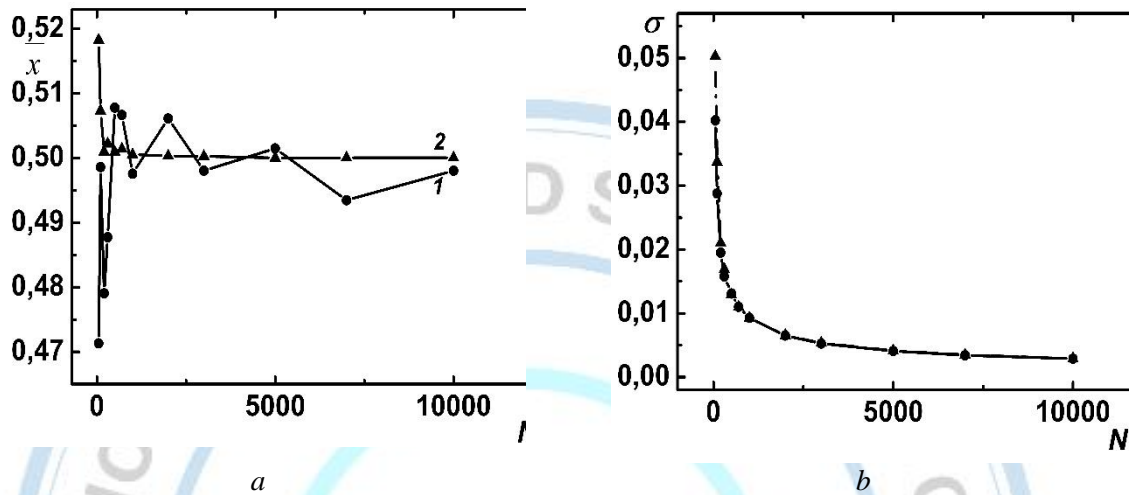


Fig.1(a,b) The dependence of the mean value  $\bar{x}$  (a) and standard deviation  $\sigma$  (b) of the set of pseudo-random numbers generated by the Fortran compiler (curve 1, points denoted by symbol  $\bullet$ ), improved Fortran (curve 2 points denoted by symbol  $\blacktriangle$ ) on the number of pseudo-random numbers.

As can be seen from Fig.1(a), the average value of pseudo-random numbers fluctuates around 0.5 and reaches a stable value when the number of random numbers is 7000.

As can be seen from Fig.1(b), the standard deviation decreases with increasing number of pseudo-random numbers.

Fig.1(c,d) shows the dependence of the coefficient of asymmetry (a) and the coefficient of correlation (b) of the set of pseudo-random numbers generated by the Fortran compiler on the number of pseudo-random numbers.

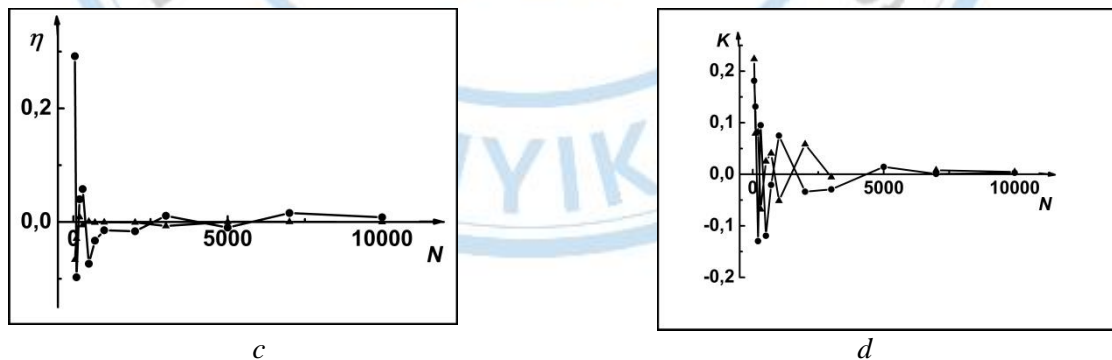


Fig.1(c,d) The dependence of the correlation coefficient (c) and asymmetry coefficient (d) of a sequence of pseudo-random numbers generated by the Fortran compiler on the number of pseudo-random numbers.

As can be seen from Fig.1(c,d), the value of the coefficient of asymmetry and the coefficient of correlation with an increase in the number of pseudo-random numbers converge to a stable value zero.

Fig.1(e,f) shows the dependence of the coefficient polydispersity and the number of pseudo-random numbers with the same values on the number of pseudo-random numbers generated by the Fortran compiler.

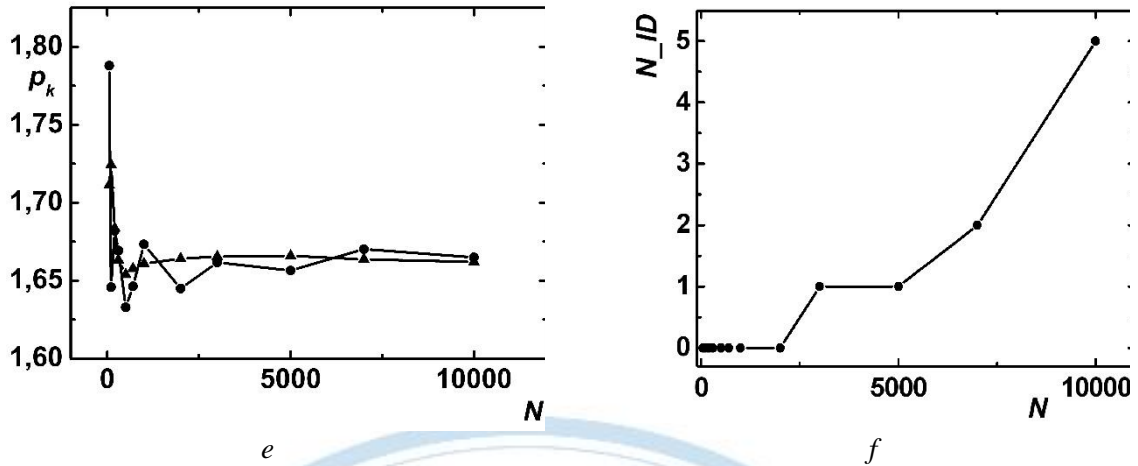


Fig.1(e,f) The dependence of the coefficient of polydispersity (e) and the number of pseudo-random numbers with the same values (f) set of pseudo-random numbers generated by the Fortran compiler on the number set of pseudo-random numbers.

As can be seen from Fig.1(e), the value of the coefficient of polydispersity with an increase in the number of pseudo-random numbers converges to a stable value 1.67.

As can be seen from Fig.1(f), the number of pseudo-random ones with the same value when generating them in the amount of 10,000 is 5

It is known that the standard deviation of a set of pseudorandom numbers determines the value of the error in the calculations used by the pseudorandom numbers (Knuth DE., 1998; Forsythe GE., Malcolm MA. et al., 1977). Consequently, the dependence of the standard deviation on the number of pseudo-random numbers makes it possible to determine the minimum number of pseudo-random numbers for their application in the different areas mathematics, physics, economics, technology and etc..

The dependence of standard deviation  $\sigma$  of the set of pseudo-random numbers generated by various generators on the number of pseudo-random numbers is similar. Therefore, we described the graphical dependence  $\sigma=\sigma(N)$  by the formula

$$\sigma(N) = \sigma_0 + a_1 e^{-\frac{N}{b_1}} + a_2 e^{-\frac{N}{b_2}}$$

and has been determined parameters  $\sigma_0, a_1, b_1, a_2, b_2$ . Future in order to determine the faster converging dependencies of the  $\sigma=\sigma(N)$  among the set of pseudo-random numbers generated by various methods, the radius of curvature of the dependence (8) was determined. The radius of curvature ( $R$ ) was determined by the formula (Zorich VA., 2013):

$$R = \frac{\left(1 + (\sigma(N)')^2\right)^{3/2}}{|\sigma(N)''|}$$

The evaluation of the curvature radius showed that of the dependencies of the standard deviation from the number of pseudo-random quantities for a plurality of pseudo-random quantities generated by various methods is practically same. The proposed method does not allow us to determine an effective method for generating pseudorandom numbers using the standard deviation parameter.

Other hand, the use of pseudo-random numbers in the integration of one and two-fold integrals by the Monte-Carlo method showed that the uniformity of the distribution of random numbers is of great importance.

Fig.2(a) shows the dependence of the number of pseudo-random numbers falling within a unit interval ( $N_i$ ) on the change interval for pseudo-random numbers in the amount of  $N=7000$ . In this case, the average number expected to fall within the interval should be 350.

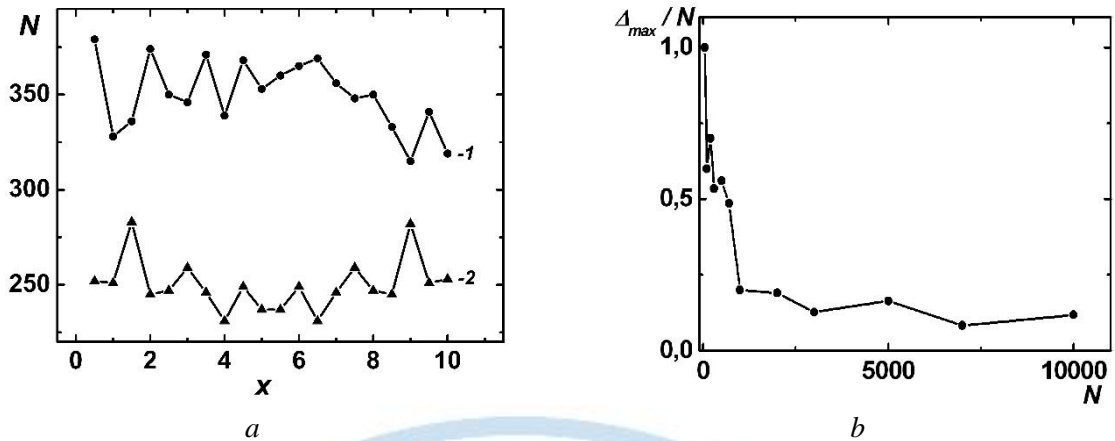


Fig.2(a, b) dependence of the number of pseudo-random numbers falling within the unit interval on the interval of change  $N=10000$  (a), the maximum deviation of the numbers of pseudo-random numbers ( $\Delta N_i=N_i-N_{mean}$ ) to the number of generated pseudo-random numbers ( $N$ ) on the number of generated pseudo-random numbers ( $N$ ) (b).

As can be seen from fig.2(a) the deviation of the number of random numbers from the average value (350 for random number generated by Fortran compiler and 250 by improved method) decreases faster for improved Fortran compiler.

Fig.2(b) shows the relationship between the maximum deviation of the numbers of pseudo-random numbers ( $\Delta N_i=N_i-N_{mean}$ ) to the number of generated pseudo-random numbers ( $N$ ) on the number of generated pseudo-random numbers ( $N$ ). The condition  $\frac{\Delta_{max}}{N} \leq 0.08$  can be taken as a criterion for the uniform distribution of pseudorandom numbers. As can be seen from fig.2(b) at big number random numbers their distribution become uniformity.

Investigation of the uniformity of the distribution of a set of pseudorandom numbers over more than one set is associated with their use in the integration of single- and multivariable functions, and the study of percolation of particles in the plane and volume.

Since with large numbers of pseudo-random numbers the asymmetry coefficient approaches zero, then the distribution function of pseudorandom numbers over their values can be described using a Gaussian (normal) function with a mean size and standard deviation:

$$F(x) = A_n \cdot e^{-\frac{(x-\bar{x})^2}{2\sigma^2}}$$

where  $A_n$  – normalization factor. The value of  $A_n$  is determined from the condition

$$\int_{x_{min}}^{x_{max}} F(x) dx = \int_{x_{min}}^{x_{max}} A_n \cdot e^{-\frac{(x-\bar{x})^2}{2\sigma^2}} dx = 1$$

Fig.3(a) shows the distribution functions of set of 7000 pseudo-random numbers generated by the Fortran compiler.

Fig.3(b) shows the distribution histogram of a set of 7000 pseudo-random numbers when dividing the interval of their values by 20 equal sub-intervals. As can be seen from Fig.3(b), the histogram probability values for divided intervals are different, and this shows the inequality of the distribution of pseudo-random numbers. The probability of passing to the subinterval should have been  $p=350/7000 = 0.5$ .



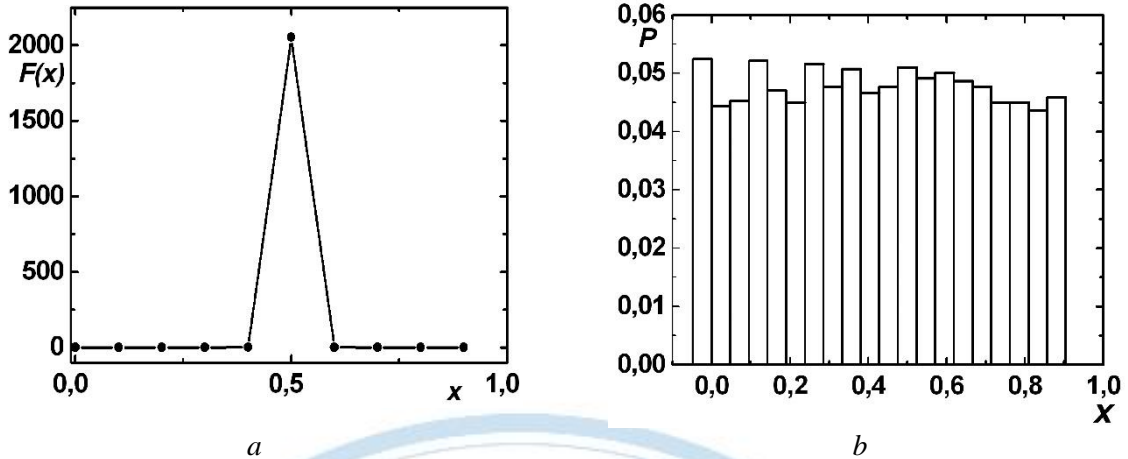


Fig.3(a,b) Distribution function (a) and a histogram of the distribution of a set of pseudo-pseudo-random numbers generated by the Fortran compiler on number of random numbers .

Thus, analysis of the resulting set of pseudo-random numbers showed that pseudo-random numbers generated by Fortran and C++ compilers should be more efficient for use in MC applications.

As can be seen from Fig.1(a), the average value of the set of random numbers, depending on the number of random numbers, fluctuates around its stable value of 0.5.

In order to achieve a uniform distribution of the set of random numbers, at their small number, when generating random numbers, those random numbers were selected that satisfied the condition  $Rnd = \bar{x} \pm \Delta$ .

To eliminate correlation between random numbers, we generated integer random numbers. Next, the sequence of random numbers was determined by the number of the array of random integers.

Below is a program for generating random numbers, according to the algorithm proposed above, written in the Fortran algorithmic language.

```

IMPLICIT REAL*8(A-H,O-Z)
DIMENSION RNDM(0:100000),
RND2M(100000)
INTEGER NRNDM(100000)

OPEN(UNIT=6,
FILE='UNFRM_RND_FRTRN.DAT')

N=10000
RNDSRD=0.5
I=0
7 CALL RANDOM_NUMBER(R)

DO 1 J=0,I
IF((RND1.EQ.RNDM(J)).OR.(RND2.EQ.RN
DM(J))) GOTO 7
1 CONTINUE

DLT=RND1-RNDSRD
IF(DLT.GT.0.) GOTO 2
IF(DLT.LT.0.) GOTO 3
IF(DLT.EQ.0.) GOTO 7

2 RND2=RNDSRD-DLT
GOTO 4

C *****
C GENERATING RANDOM INTEGER
C *****
8 I=1
9 CALL RANDOM_NUMBER(R)

NR=INT(R*N)

DO 10 J=1,I
IF(NR.EQ.NRNDM(J)) GOTO 9
10 CONTINUE

NRNDM(I)=NR
I=I+1
IF(I.GT.N) GOTO 11
GOTO 9

C *****
C CHANGING THE ELEMENT NUMBER OF
THE RNDM ARRAY ACCORDING TO THE
NRNDM ARRAY
C *****

11 DO 12 I=1,N
K=NRNDM(I)
RND2M(I)=RNDM(K)

```

3 RND2=RNDSRD-DLT  
 4 RNDM(I)=RND1

I=I+1  
 RNDM(I)=RND2

I=I+1  
 IF(I.GT.N) GOTO 8  
 GOTO 7

12 CONTINUE

C \*\*\*\*\*  
 C WRITE REULTS TO FILE  
 C \*\*\*\*\*  
 WRITE(6,13) N  
 13 FORMAT(I6)  
 WRITE(6,14)(RND2M(I), I=1, N)  
 14 FORMAT(6(TR1,F10.7))  
 STOP  
 END

As can be seen from Fig.1(a,b,c,d,e,f), the statistical parameters of the set of random numbers generated by the improved method with smaller numbers of random numbers converge to stable value.

Following integrals I.  $\int_{-\infty}^{\infty} e^{-x^2} dx$ , II.  $\int_1^{\pi/2} e^{-x} \sin(x) dx$ , III.  $\int_1^{\pi/2} \sqrt{x} \sin(x) dx$ , IV.  $\int_{0.1}^1 \frac{e^{-x}}{x} dx$ , V.

$\int_{0.1}^1 e^{-x} \ln(x) dx$  and VI.  $\int_{-1}^1 e^{-x} \delta(x) dx$  was estimated by Monte Carlo method using random numbers

generated by a Fortran compiler and an improved method. The program for estimating integrals was written by the authors in the algorithmic language Fortran on the base algorithm given in (Rogers R., 2013). Previously these integrals has been estimated by Newton-Kotes method (Rogers R., 2013.) and following values has been obtained: I. 1.76881, II. 0.152346, III. 0.614593, IV. 3.55818, VI. 0.480137.

Calculation of above indicated integrals by Monte-Carlo method using different number of random number generated by Fortran compiler and improved variant showed that, the value of the integrals, depending on the number of random numbers used, fluctuates around its exact value, and with an increase in the number of random numbers, the deviation of the integral value from the exact value decreases.

The minimum number of random numbers for accurate calculation of integrals by the Monte Carlo method was determined from the condition that relative error

$$Rerror = \frac{Abs(Intgr(Newton - Kotes) - Intgr(Rnd(N_i)))}{Intgr(Newton - Kotes)}$$

should be the minimum among the

calculated integrals. Here  $Intgr(Rnd(N_i))$  is value of integral calculated using  $N_i$  number of random numbers. In the table are given value of integrals I-VI, required minimal number of random numbers for integration and realtive error of calculations. In the table, a set of random numbers generated by the Fortran compiler and an improved method are designated Frtrn1 and Frtrn2.

Table. Results of integration of functions I.  $\int_{-\infty}^{\infty} e^{-x^2} dx$ , II.  $\int_1^{\pi/2} e^{-x} \sin(x) dx$ , III.  $\int_1^{\pi/2} \sqrt{x} \sin(x) dx$ , IV.

$$\int_{0.1}^1 \frac{e^{-x}}{x} dx, V. \int_{0.1}^1 e^{-x} \ln(x) dx, VI. \lim_{\epsilon \rightarrow 0} \int_{0.1}^1 e^{-x} \frac{1}{2} \epsilon |x|^{\epsilon-1} dx$$

Random Number Generator	Integregration value	Minimal Number	Relative Error
<b>Integrated Function I</b>			
<b>Frtrn1</b>	1.76875	16000	0.00003394
<b>Frtrn2</b>	1.76421053	19000	0.00260034
<b>Integrated Function II</b>			
<b>Frtrn1</b>	0.1525469	300	0.00131869
<b>Frtrn2</b>	0.15284139	200	0.00325174
<b>Integrated Function III</b>			
<b>Frtrn1</b>	0.48030748	100	0.21849507
<b>Frtrn2</b>	0.48030748	100	0.21849507
<b>Integrated Function IV</b>			
<b>Frtrn1</b>	1.95444879	100	0.45071673
<b>Frtrn2</b>	2.28019025	100	0.35916952
<b>Integrated Function V</b>			
<b>Frtrn1</b>	-1.23757829	100	0.7574413
<b>Frtrn2</b>	-1.18854741	50	0
<b>Integrated Function VI</b>			
<b>Frtrn1</b>	1.04393853	15000	0.00009435
<b>Frtrn2</b>	1.04938322	15000	0.00531036

As seen from table the use of set of random numbers obtained with an improved method in integration does not always give a good result. Although the dependencies  $\bar{x} = \bar{x}(N)$ ,  $\eta = \eta(N)$  and  $\varepsilon = \varepsilon(N)$  are better for it than random numbers compiled with Fortran alorithmic language.

## CONCLUSIONS

The results of statistical analysis of set of pseudo-random numbers showed that their statistical parameters depend on the number of pseudo-random numbers in set. As the number of pseudorandom numbers in the set increases, the statistical parameters: mean value, standard deviation, asymmetry coefficient, correlation coefficient, polydispersity coefficient approach their stable values.

Analysis of the results of statistical analysis of a set of pseudorandom numbers and their use in calculating one- and two-fold integrals and modeling a physical process (percolation of magnetite nanoparticles) showed that pseudorandom numbers obtained on the Fortran-e compiler are more effective.

The results of the analysis showed that the idenity of the set of pseudo-random numbers is one of the main characteristics of the their.

Also is neccessry note, that pseudo-random numbers generated by different versions of the Fortran compiler (Visual Fortran 6.6, Fortran 77) also differ. To accurately calculate a two fold integral in Visual Fortran 6.6, 6000 pseudorandom numbers are required, and in Fortran 77, 4000 are required.

The integration of the proposed functions I-IV using random numbers generated by the Fortran algorithmic language compiler with further improvement is more effective.

Statistical analysis of set of pseudo-random numbers was performed using a program written in Fortran algorithmic language and Mathematica 10. The graphics are built using the Origin-8.5 program and edited using the Adobe Photoshop 8 graphics editor.

## References

- Landau DP., Binder K., 2015. A Guide to Monte Carlo Simulations in Statistical Physics. Fourth Edition Cambridge University Press, 519p.  
 Gould H., Tobochnik J. et al., 2016. An Introduction to Computer Simulation Methods Applications to



- Physical System. August 27, p.785.
- Yinghong Z., Jianguo W. 2012. Application of Monte Carlo method to solving boundary value problem of differential equations. *J. High Power Laser and Particle Beams*, 24: 3023-3027. doi: 10.3788/HPLPB20122412.3023 shu.
- ZhiMin, Hong, ZaiZai, Yan et al., 2012. Monte Carlo Method for solving the Fredholm integral equations of the second kind. *Transport Theory and Statistical Physics*, Volume 41, Issue 7, pp.513-528 Pub Date: December 2012 DOI: <https://doi.org/10.1080/00411450.2012.695317>.
- Sjostrand T., 2016. Status and developments of event generators. *LU TP 16-47, MCnet-16-36*, arXiv:1608.06425 [hep-ph] August.
- Buckley A., Butterworth J. et al. , 2016. General-purpose event generators for LHC physics. arXiv:1101.2599v1 [hep-ph] 13.
- Sheikh-Bagheria D., Rogers DWO., 2002. Monte Carlo calculation of nine megavoltage photon beam spectra using the BEAM code // *Medical Physics*, volume 29, No. 3.
- Knuth DE., 1998. *The art of computer programming, v.2: semi-numerical algorithms*, 3rd edn. Addison-Wesley, Reading, 688p.
- Forsythe GE., Malcolm MA. et al., 1977. *Computer methods for mathematical computations* Prentice-Hall, INC. Englewood Cliffs, N.J., 277p.
- Gould H., Tobochnik J. et al., 2016. *An Introduction to Computer Simulation Methods Applications to Physical System*, 785p.
- <https://www.programiz.com/cpp-programming/online-compiler>.
- <https://onecompiler.com/fortran/3xsau3ceu>.
- James F., Moneta L. 2020. Review of high quality random number generators. *Computing and Software for Big Science*, 4:2 <https://doi.org/10.1007/s41781-019-0034-3>.
- Rukhin A., Soto J. et al., 2010. A statistical test suite for random and pseudorandom number generators for cryptographic applications. National Institute of Standards and Technology, Technology Administration U.S. Department of Commerce, Special Publication 800-22, Revision 1a
- Ryabko B., 2022. Asymptotically most powerful tests for random number generators // *Journal of Statistical Planning and Inference*, 217, pp.1-7
- Kang M., 2005. Efficiency test of pseudorandom number generators using random walks. *Journal of Computational and Applied Mathematics*, volume 174, Issue 1,1, pp.165-177, <https://doi.Org/10.1016/j.cam.2004.04.005>
- Hudson D.J., 1974. *Statistics: Lectures on elementary statistics and probability*. Geneva: CERN, 211p.
- Feller W., 1963. *An introduction to probability theory and its applications*. New York: Wiley, 509p.
- Irani R.R., Calls CF. 1963. *Particle size measurement. Interpretation and application*. New York: Wiley, 165p.
- Ali-zade RA., 2008. Size distribution of magnetite nanoparticles in disperse systems. *Inorganic Materials*, 2008, volume 44, No. 2, pp.165–170. ISSN 0020-1685, © Pleiades Publishing, Ltd.. [https://rosettacode.org/wiki/remove\\_duplicate\\_elements#Fortran](https://rosettacode.org/wiki/remove_duplicate_elements#Fortran).
- Zorich VA., 2013. *Mathematical analysis I*. Springer. Second Edition. 576p.
- Rogers R., 2013. *Digital methods*. The MIT Press. DOI: <https://doi.org/10.7551/mitpress/8718.001.0001>, ISBN electronic: 9780262313384. 2013.

#### **Conflict of Interest**

The authors have declared that there is no conflict of interest.

#### **Author Contributions**

Contributions of the authors to the study can be explained.

## Performance Comparison of Classification Algorithms Using Feature Selection Methods in Machine Learning

Aylin Uçan<sup>1\*</sup>, Doğan Yıldız<sup>2</sup>, Nihat Tak<sup>3</sup>

<sup>1</sup>Yıldız Teknik Üniversitesi, İstatistik, 34220, İstanbul, Türkiye

<sup>2</sup>Yıldız Teknik Üniversitesi, İstatistik, 34220, İstanbul, Türkiye

<sup>3</sup>Marmara Üniversitesi, İstatistik, 34730, İstanbul, Türkiye

\*Corresponding author e-mail: aynucn@gmail.com

### *Abstract*

*Feature selection is important in machine learning and data preprocessing processes. Selecting more important features allows better generalization of the model. It also helps reduce the complexity of the model. Thus, more accurate and reliable results can be obtained in the analysis of classification and prediction problems. In the study, Recursive Feature Elimination, Random Forest and Boruta Feature Selection methods are used for important features in the chronic kidney disease dataset. Then, the data sets formed with the selected features are analyzed using Support Vector Machines, k-Nearest Neighbors and Naive Bayes classifiers, which are commonly used classification techniques in the field of machine learning. And finally, we find the best method in the study by calculating the classification accuracy values.*

**Keywords:** Boruta, Classification, Feature selection, Random Forest, Recursive Feature Elimination

### **INTRODUCTION**

In recent years, digitalization and technological advancements have led to faster data production by individuals and institutions in recent years. As a result of these developments, the size of datasets has increased, and they have become more complex. This situation has particularly contributed to the widespread adoption of machine learning in various aspects, such as data analysis, prediction, and automated decision-making. Using all features to train a model can lead to overfitting. Therefore, feature selection is important in data preprocessing as well as in training the model in data analysis.

With feature selection, it is possible to save the training time of the model, improve model training, achieve higher predictions with minimum errors in classification analyses, and provide cost savings. "Feature selection is a technique that effectively reduces the dimensionality of the feature space by eliminating irrelevant and redundant features without significantly affecting the decision-making quality of the trained model."(Theng & Bhoyar, 2023) This study focuses on the utilization of various feature selection methods and the comparison of their performance with classification methods. Recursive Feature Elimination, Random Forest, and Boruta feature selection methods are used to achieve the highest classification accuracy with the fewest features. Also is about a classification problem where different methods' accuracy rates are compared to assess their performance. In the application part, Support Vector Machines, k-Nearest Neighbors, and Naive Bayes were initially examined to evaluate their classification performance without feature selection. Subsequently, Recursive Feature Elimination, Random Forest, and Boruta feature selection methods are applied to identify important features in the dataset, resulting in the creation of three different subsets.

The remaining part of the study follows a literature review section, where classification and feature selection methods are briefly explained in the methodology section. In the results and discussion section, details are provided regarding the dataset preprocessing and the outcomes obtained from the specified

methods. The performance of models is compared based on accuracy rates. In the conclusion section, the study attempts to determine which classification and feature selection methods are more effective.

## LITERATURE REVIEW

Today's rapidly advancing field of machine learning, research on classification methods and feature selection techniques has become crucial. This study aims to compare the performance of various classification methods and feature selection techniques. This section summarizes some prominent studies in literature related to this topic.

Karabulut et al. (2012) conducted a study where they used various feature selection methods on different datasets including Information Gain, Gain Ratio, Symmetrical Uncertainty, Relief-F, One-R, and Chi-square. The classification methods employed in the study were Naive Bayes, Multi-Layer Perceptron, and J48 decision tree methods. It was observed that Gain Ratio was the most effective feature selection algorithm for Naive Bayes classifier, Chi-square for Multi-Layer Perceptron, and Information Gain for J48, according to the study's findings (Karabulut, Özel, & İbrikiçi, 2012).

Begum et al. (2015) analyzed the classification performance of the k-Nearest Neighbors method on a dataset, along with identifying significant features using Consistency-based Feature Selection, Fuzzy Preference-based Rough Clustering, and Kernel-based Fuzzy Rough Clustering methods. They observed that Consistency-based Feature Selection outperformed the other methods in terms of identifying important features on the dataset. (Begum, Chakraborty, & Sarkar, 2015).

Chen et al. (2020) examined three different datasets. For feature selection across all datasets, they utilized Recursive Feature Elimination, Boruta, and Random Forest methods. They compared the performance of Random Forest, Support Vector Machines, k-Nearest Neighbors, and Linear Discriminant Analysis methods for classification tasks. The study found that the Random Forest feature selection method achieved better performance with the Random Forest classifier across all groups of datasets (Chen, Dewi, Huang, & Caraka, 2020).

Saygin et al. (2020) focused on early diagnosis of liver diseases using Forward Selection, a spiral feature selection method, to determine the most important features. They utilized Support Vector Machines, Multi-Layer Perceptron, Decision Trees, Logistic Regression, and Light Gradient Boosting Machine classifiers on the dataset created with the identified features. Among these methods, the Light Gradient Boosting Machine classifier achieved the highest diagnostic success rate (Saygin & Baykara, 2021).

Lastly Deperlioğlu (2023) applied Genetic Algorithms (GA) for feature selection on various medical datasets and employed 7 different supervised classification methods. They observed that the Random Forest classification method yielded better results across all datasets compared to the other algorithms (Deperlioğlu, 2023).

## MATERIALS AND METHODS

### Feature Selection Analysis

For the feature selection part in the classification problem, three different algorithms were used to identify important features in the dataset and create subsets. These algorithms are Random Forest, Recursive Feature Elimination, and Boruta feature selection methods.

#### *Random Forest*

Random Forest (RF) algorithm holds a significant position in the field of ensemble learning. This algorithm is commonly preferred for analyzing important features in a dataset. Fundamentally, the RF algorithm is based on decision tree algorithms and decides by aggregating the results of all decision trees. Essentially, each decision tree is trained using a randomly chosen subset of the data and features.



The RF algorithm reduces overfitting and improves generalization by averaging the predictions of individual trees. It is particularly used to determine the feature that contributes most to the model's performance. In this regard, the algorithm uses various metrics to calculate feature importance. For example, it computes feature importance by reducing irregularities in the splitting process of features. These irregularities are measured with metrics such as the Gini coefficient, information gain, or entropy. The operation of the algorithm generally proceeds through the following steps: First, after determining the target feature, for each feature, it randomly shuffles the feature values without changing the target feature, thus randomizing the relationship between features and the target. Then, it calculates the decrease in performance for each feature. The larger this decrease, the more important the feature is considered. The algorithm repeats this process for all features and continues until it reaches a specified criterion or determines the order of importance of the features.

#### *Recursive Feature Elimination*

Recursive Feature Elimination (RFE) aims to maximize prediction accuracy by iteratively removing less important features to construct the optimal subset of features. This algorithm utilizes a machine learning algorithm and an importance ranking metric to determine the impact of each feature on model performance. Various machine learning algorithms such as Random Forest, Linear Regression, Logistic Regression, among others, can be used for importance ranking.

The RFE algorithm works as follows: first, all features are ranked by their importance using a selected machine learning algorithm. Then, the feature with the lowest importance is excluded from the model, and a new model is created with the remaining features. These steps are repeated backwards, and performance evaluations are conducted for all scenarios. The algorithm reduces the complexity of the model, lowers computational costs, and enhances generalization ability by selecting important features and eliminating unnecessary or less important ones. This allows for the creation of more effective and optimized models.

#### *Boruta Algorithm*

The Boruta algorithm is also a wrapper feature selection method. Based on the Random Forest algorithm, it attempts to find features in the dataset that may be important according to a specified "outcome" feature.

The Boruta algorithm operates as follows: First, it randomly shuffles the values of each feature in the dataset to create new "shadow" features, which are then included in the dataset. Next, it calculates importance scores for each feature using metrics such as "Mean Decrease Impurity." The algorithm compares the Z-scores between real and shadow features to determine if each real feature is more important than its corresponding shadow feature, recording these as "hits." Then, it identifies features that perform better than their shuffled copies by comparing the Z-scores of the shuffled copies with the original features' Z-scores using a binomial distribution to calculate the probability of real features outperforming shadow features. If there is a statistically significant difference, indicating that real features achieve success more frequently than shadow features, those real features are considered important. The algorithm stops after a specified number of iterations or once all features are confirmed or rejected. This process helps determine the importance ranking of features and contributes to improving the overall performance of the model.

#### **Classifiers Methods**

In this study, three different methods were used for the classification stage of the dataset. These methods are Naive Bayes, k-Nearest Neighbors, and Support Vector Machines algorithms. In this section, these classification methods are briefly discussed.

### *Naive Bayes*

Naive Bayes is a simple and understandable machine learning algorithm that performs classification using Bayes' theorem. This method, the probability of an example belonging to a specific class can be calculated. Bayes' theorem is defined as follows:

$$P(H|X) = \frac{P(X|H) \cdot P(H)}{P(X)} \quad (1)$$

Based on Bayes theorem, the algorithm of the Naive Bayes classifier is as follows that assuming  $D$  represents the dataset where each  $X$  in  $D$  is associated with a specific class label, and let  $X$  be a vector consisting of  $n$  features, defined as  $X = (x_1, x_2, \dots, x_n)$ . Let  $C_1, C_2, \dots, C_m$  denote  $m$  distinct classes represented. The Naive Bayes classifier aims to determine if an  $X$  vector belongs to class  $C_i$  by finding the class with the highest conditional probability  $P(C_i | X)$  among all classes. This situation is expressed using Bayes' theorem, as shown in equation 2 (Kaynar, Tuna, Görmez, & Deveci, 2017).

$$P(C_i|X) = \frac{P(X|C_i) \cdot P(C_i)}{P(X)} \quad (2)$$

Since  $P(X)$  is the same for all classes, only the expression  $P(X | C_i) P(C_i)$  needs to be maximized. The term  $P(C_i)$  represents the ratio of the number of elements in class  $C_i$  to the total number of elements. The expression  $P(X | C_i)$  is calculated as shown in equation 3, assuming  $X$  is a vector of  $n$  values representing features

$$P(X | C_i) = \prod_{k=1}^n P(X_k | C_i) \quad (3)$$

As a result, the classifier selects the class  $C_i$  from the sample space, where the class value corresponds to the highest expression of  $P(X | C_i) P(C_i)$ , considering  $X$  vector as the sample space. (Kaynar, Tuna, Görmez, & Deveci, 2017).

### *k-Nearest Neighbors*

The  $k$ -nearest neighbors algorithm is a classification method proposed by T. M. Cover and P. E. Hart, where the class of a sample data point is determined based on the class of its nearest neighbors, according to a specified value of  $k$ . (Taşçı & Onan, 2017). The  $k$ -nearest neighbors algorithm considers the outputs of the closest  $k$  neighbors in the training data to estimate the class to which a given input vector belongs. It determines the output of the input vector based on the most frequently occurring categorical output among its nearest  $k$  neighbors. Therefore, defining the concept of "distance" and determining the number of neighbors whose outputs will be used in the classification decision, i.e., the value of 'k', is of critical importance (Öz & Alp, 2019).

The most used proximity metric in the literature is the 'Euclidean' distance. Additionally, distance metrics such as Manhattan, Chebyshev, and Minkowski can also be used. The choice of the number of 'k' neighbors to be used in the algorithm depends on the dataset's features, size, and the context of the problem. After splitting the dataset into two parts for training and testing, cross-validation is generally the most common and reliable method used on the training dataset. In each cross-validation iteration, the algorithm builds a  $k$ -Nearest Neighbors model with a different  $k$  value selected, and trains it using the training data. Subsequently, the created model is evaluated on the allocated test data, and performance metrics are calculated.

### *Support Vector Machine*

Support Vector Machines (SVM) is a method with a strong mathematical foundation. SVM constructs an  $n$ -dimensional hyperplane to separate data into two categories. As a non-parametric supervised classifier, SVM is widely used for classification purposes. Generally, SVM can be categorized into linear and nonlinear SVMs. The primary objective of SVM is to determine where to place the hyperplane in space. (Öz & Alp, 2019).

Theoretically, the features we consider explaining the target feature are of infinite dimensions.

Having many features can make solving the problem costly. In such cases, kernel functions come into play to solve the problem. Kernel functions are used to handle complex data structures more simply and to improve classification accuracy. Additionally, these functions reduce computational costs, enabling more efficient operation on large datasets. In addition, the SVM algorithm has different kernel functions, these should be taken into consideration and the appropriate kernel function should be selected.

### Model Performance Evaluation

In classification problems, performance is typically evaluated based on accuracy calculations. Accuracy measures how often the trained model is correct and is depicted using a confusion matrix. A confusion matrix summarizes the prediction results for a classification problem (Chen, Dewi, Huang, & Caraka, 2020). Confusion matrix is a metric table used to evaluate the performance of a model in classification problems. It typically includes actual and predicted class values, showing the model's ability to correctly and incorrectly predict each class. An example confusion matrix is shown in Table 1.

Table 6 : Confusion matrix

Confusion Matrix		
Actual/Predicted	Positives	Negatives
Positives	True Positives	False Negatives
Negatives	False Positives	True Negatives

Confusion matrix terms like True Positive (TP), False Positive (FP), True Negative (TN), and False Negative (FN) are crucial for evaluating a classification model by quantifying correct and incorrect predictions of positive and negative examples. Several performance metrics can be calculated from this matrix. Commonly used metrics include accuracy, precision, recall (sensitivity), and specificity. These metrics are calculated as shown in the following formulas.

$$\text{Accuracy: } (TP + TN) / (TP + TN + FP + FN) \quad (4)$$

$$\text{Sensitivity: } (TP) / (TP + FN) \quad (5)$$

$$\text{Specificity: } (TN) / (TN + FP) \quad (6)$$

$$\text{Precision: } (TP) / (TP + FP) \quad (7)$$

Additionally, the Kappa test is also widely used. The Kappa test is a statistical test that measures the reliability of agreements between two or more observers. It provides a performance measure beyond accuracy, particularly considering imbalanced class distributions often encountered in classification problems. The Kappa value measures the agreement between the actual observations and the predictions of the model, relative to the agreement expected by chance among observers making random guesses. The formula for Kappa value is as follows.

$$k = \frac{P_0 - P_c}{1 - P_c} \quad (8)$$

Here,  $P_0$  represents the observed agreement rate, and  $P_c$  indicates the expected agreement rate. If the Kappa value is less than 0.20, it is considered insignificant; between 0.21 and 0.40, it is deemed slight; between 0.41 and 0.60, it is moderate; between 0.61 and 0.80, it is substantial; and between 0.81 and 1.00, it indicates almost perfect agreement between the actual observations and the model's predictions (Chen, Dewi, Huang, & Caraka, 2020).

## RESULTS AND DISCUSSION

### Dataset Descriptions and Preprocessing

In this study, data related to chronic kidney disease collected in 2015 from Apollo Hospital in India were utilized. This dataset, which is still publicly available on the UCI (University of California) Machine Learning Repository, consists of 400 observations and 25 features (<https://archive.ics.uci.edu>). Upon examination of the dataset, it was found that out of 400 individuals, 250 were diagnosed with chronic



kidney disease, while 150 were classified as not having chronic kidney disease. The features in this dataset are related to various health indicators and blood test results. These parameters include patients' age, blood pressure, specific gravity of urine, albumin and sugar levels, and counts of red and white blood cells. Additionally, medical conditions such as hypertension, diabetes mellitus, and coronary artery disease, as well as symptoms like appetite, pedal edema, and anemia are also included. The dataset is used for classification purposes based on this information.

As stated in the introduction, contemporary datasets often contain missing, noisy, unnecessary, inconsistent, and differently scaled data. Clinical datasets frequently encounter such issues. It is recommended that every data analysis, including applications like machine learning, begins with examining and addressing these issues through necessary adjustments. These stages are commonly known as the 'data preprocessing' process. Feature selection is also part of this process but will be described in detail as it is the focus of this study.

For other data preprocessing processes, the study of Almasoud & Ward was followed. For outlier analysis, which is one of the data preprocessing processes, each outlier identified upon examining the original dataset was checked for its realism. In this study, extreme data points exceeding medically acceptable ranges were treated as missing data. For missing value analysis, when considering all values in the original dataset, the proportion of missing data is approximately 10%. It was observed that the missing data were not random. Therefore, multiple imputation was performed to complete missing values in the CKD dataset for this study. (Almasoud & Ward, 2013). For Data transformation, the dataset under study is a multivariate dataset. In multivariate analysis, features often have different units; however, in some cases, it yields better results if the data are in the same unit. For this purpose, feature values are standardized to convert them into the same unit. (Alpar, 2021). the categorical features in the dataset, which were defined as yes-no, have been converted to 0 - 1. All other numerical features have been standardized using the Z-score method, based on the mean and spread of the data distribution, to ensure that each feature is on the same scale.

#### **Analysis of Feature Selection Method Results**

The dataset was divided into 70% training and 30% test sets for application preparation. Using the training set consisting of 280 observations and 25 features, three feature selection algorithms were employed to identify significant features. Subsequently, these features were used to create three different subsets of data in the test set.

Figure 1 shows the important rankings of features determined by the Random Forest algorithm. On the graph, feature names are shown on the y-axis, while mean decrease in importance values are shown on the x-axis. A higher mean decrease in importance value indicates a greater importance of the feature on the dependent feature. Upon examining Figure 1, we observe a decrease in importance rankings after the top 6 or top 13 features. Based on our experimentation and performance in classification, we decided to create a subset using the Random Forest feature selection method with 6 features. These features are coded as follows: 'hemo', 'pcv', 'sg', 'sc', 'al', 'rc'.

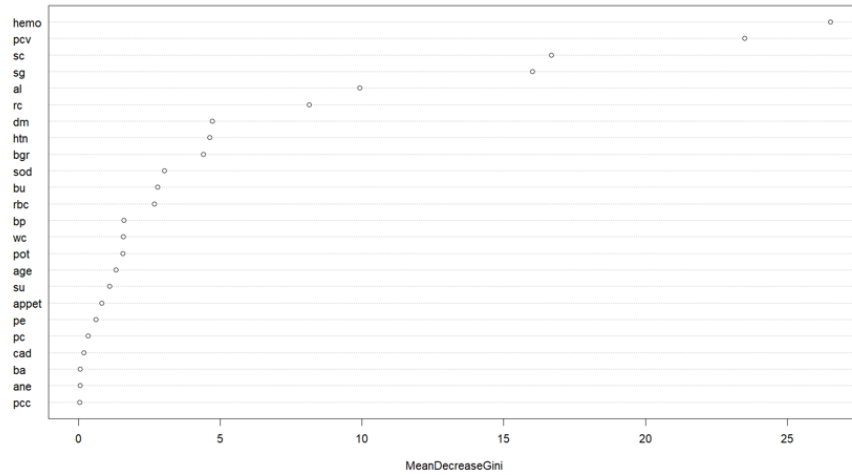


Figure 3. Importance of features in the dataset according to the random forest feature selection method

Figure 2 obtained from the Recursive Feature Selection algorithm shows the number of features included in each iteration on the x-axis and the corresponding accuracy rates of the algorithm on the y-axis. These accuracy rates serve as a measure to estimate how well a model can be constructed when combining the selected features with a classification method (function = random forest). Therefore, this accuracy value is used to gauge the effectiveness of the Recursive Feature Selection process. The program output evaluates scenarios from 1 to 25 possible numbers of features, presenting significant features corresponding to the highest accuracy rate and the number of features. Upon reviewing the outputs, it was observed that the highest accuracy rate was achieved with at least 12 features. Although the performance value was the same with 24 features included, halving the number of features can be interpreted as a positive outcome. The features selected from the dataset using Recursive Feature Selection are: 'sg', 'hemo', 'pcv', 'sc', 'rc', 'al', 'rbc', 'bgr', 'htn', 'dm', 'bu', 'bp'.

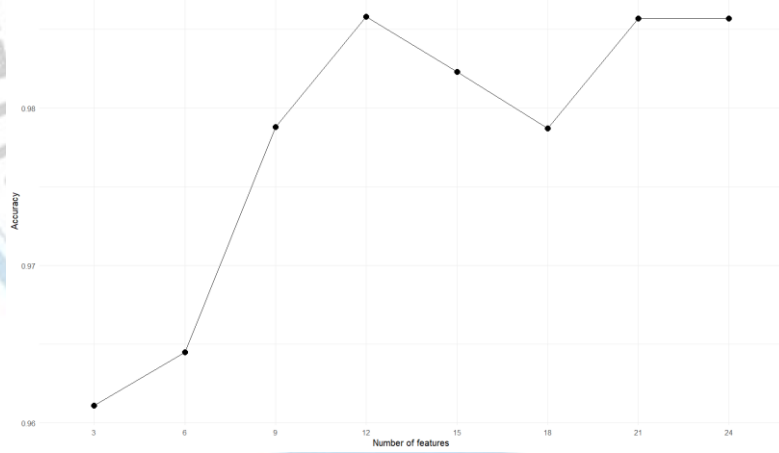


Figure 4. Accuracy values based on the number of features in the dataset according to the recursive feature selection method

Figure 3 is obtained from Boruta feature selection algorithm. In the figure, the x-axis shows the feature names, while the y-axis displays the Z scores of each feature in the dataset mentioned in Boruta algorithm steps. The blue boxplots in this table represent the minimum, mean, and maximum Z scores of a shadow feature, while the red and green boxplots respectively denote the Z scores of rejected and confirmed features. As a result of the Boruta algorithm, a subset of 22 features was selected and confirmed, represented by green-colored boxes. The selected features are: 'hemo', 'pcv', 'sg', 'sc', 'al', 'rc', 'dm', 'htn', 'bgr', 'rbc', 'bu', 'sod', 'bp', 'wc', 'pot', 'su', 'appet', 'pe', 'pc', 'ba', 'pcc', 'an'.

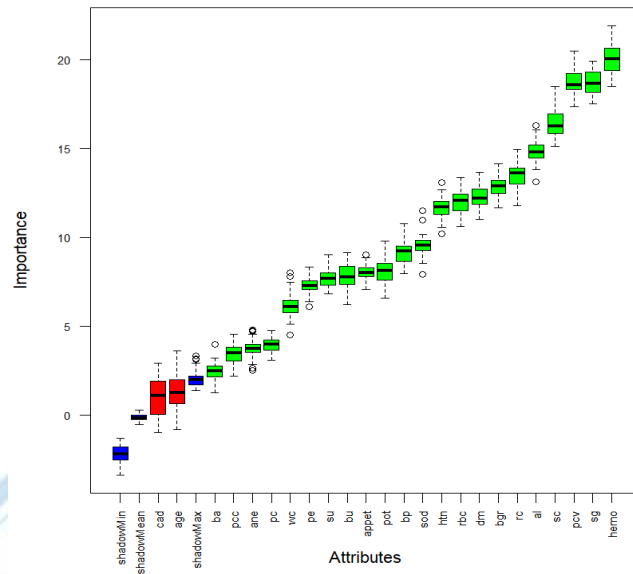


Figure 5 Importance of features in the dataset according to Boruta feature selection method

### Classification Performance Comparisons

The analysis of classification methods used in the study was repeated for both the original dataset and datasets created after feature selection methods. The training dataset was used to train classification models, while the test dataset was used to analyze the model's performance. The methods employed in classification were Naïve Bayes, Support Vector Machines (Kernel: Linear), and k-Nearest Neighbors. In this study, classification accuracy values were primarily considered for performance comparisons, with sensitivity, specificity, precision, and Kappa statistic also examined. Table 2 shows the percentage classification accuracy values and other percentage metrics resulting from the analysis of all feature selection methods on the test dataset.

In the analysis using 24 features from the original dataset, the highest classification performance was found to be 0.975 with SVM. Following feature selection methods, the dataset created with 22 features using the Boruta feature selection method achieved the highest classification performance with SVM, yielding an accuracy rate of 0.950. Similarly, the dataset created with 12 features using Recursive Feature Selection also demonstrated the highest classification performance with SVM, achieving an accuracy value of 0.975. For the dataset created with 6 features using Random Forest feature selection, the highest classification performance observed was 0.950, observed in both SVM and k-Nearest Neighbors classification methods. In general, based on these results, it can be concluded that SVM consistently achieves the highest classification performance across all feature selection methods applied to the dataset.



Table 2. Classification accuracy values of the analysis of test datasets created by feature selection methods using different classifier techniques

Feature Selection Method	Classification Method	Number of Features	Accuracy	Sensitivity	Specificity	Precision	Kappa
No Feature Selection	Support Vector Machines	24	0.975	0.978	0.973	0.957	0.947
	k-Nearest Neighbors	24	0.908	0.978	0.865	0.815	0.811
	Naive Bayes	24	0.874	0.978	0.811	0.759	0.746
Boruta	Support Vector Machines	22	0.950	0.978	0.932	0.898	0.895
	k-Nearest Neighbors	22	0.916	0.978	0.878	0.830	0.827
	Naive Bayes	22	0.874	0.978	0.811	0.759	0.746
Recursive Feature Elimination	Support Vector Machines	12	0.975	0.978	0.973	0.957	0.947
	k-Nearest Neighbors	12	0.941	0.978	0.919	0.880	0.878
	Naive Bayes	12	0.916	0.978	0.878	0.830	0.827
Random Forest	Support Vector Machines	6	0.950	0.933	0.96	0.933	0.893
	k-Nearest Neighbors	6	0.950	0.978	0.932	0.898	0.895
	Naive Bayes	6	0.941	0.956	0.932	0.896	0.877



Figure 6. Performance comparison of feature selection and classification methods

Figure 4 visualizes the classification accuracy values based on feature selection and classification methods as presented in Table 2.

## CONCLUSIONS

In this research, a comparison was made between three distinct classification techniques: Naive Bayes, Support Vector Machines, and k-Nearest Neighbors. Each classifier's performance was evaluated using Random Forest, Recursive, and Boruta feature selection methods to determine the best classifier based on accuracy. Feature selection is an important step in classification data analysis, demonstrating its importance through performance comparisons in studies. Additionally, as stated in the model performance evaluations of this study, both the original dataset and datasets created with feature selection methods were examined for classification performance. It was found that the Recursive feature selection method was most effective for Support Vector Machines classifier among the feature selection methods used in this study for Naive Bayes and k-Nearest Neighbors classification methods. Using Recursive feature selection with Support Vector Machines classifier did not significantly change the classification accuracy value for the dataset used, however the number of features could be reduced by half. Halving the number of features while maintaining the same accuracy can often lead to a simpler, more generalizable, and less complex model. This may increase the likelihood of the model performing

better on different data points. Moreover, reducing the number of features can lower the computational cost of the model and make the model training process more efficient.

In future studies, comparisons can be made between the performance of the same classification and feature selection methods using datasets with higher sample sizes and more features related to similar topics. Comparisons can be drawn between classification performances considering the significant increase in dataset dimensions and features.

## References

- Almasoud, M., & Ward, T. (2013). Detection of Chronic Kidney Disease Using Machine Learning Algorithms with Least Number of Predictors.
- Alpar, R. (2021). *Uygulamalı Çok Değişkenli İstatistiksel Yöntemler*. Ankara: Detay.
- Avcı, E., KARAKUS, S., OZMEN, O., & AVCI, D. (2018). Performance Comparison of Some Classifiers on Chronic Kidney Disease Data.
- Begum, S., Chakraborty, D., & Sarkar, R. (2015). Data Classification Using Feature Selection And kNN Machine Learning Approach. *International Conference on Computational Intelligence and Communication Networks*, 1.
- BUDAK, H. (2018). Özellik Seçim Yöntemleri ve Yeni Bir Yaklaşım. Süleyman Demirel Üniversitesi Fen Bilimleri Enstitüsü Dergisi.
- Chen, R.-C., Dewi, C., Huang, S.-W., & Caraka, R. (2020). Selecting critical features for data classification based on machine learning methods. *Journal of Big Data*.
- Demir, M. (2021). ÖZELLİK SEÇİM YÖNTEMLERİ KULLANILARAK SINIFLANDIRMA ALGORİTMALARININ PERFORMANSLARININ KARŞILAŞTIRILMASI.
- Deperlioğlu, Ö. (2023). TIBBİ VERİ KÜMELERİNDE GENETİK ALGORİTMALARLA ÖZELLİK SEÇİMİ VE. *Mühendislik Bilimleri ve Tasarım Dergisi*, 68 – 80.
- Kara, S., & Samli, R. (2021). Genetik Algoritma İle Öznitelik Seçimi Yapılarak Yazılım Projelerinin Maliyet Tahmini. *Avrupa Bilim ve Teknoloji Dergisi*.
- Karabulut, E., Özel, S., & İbrikçi, T. (2012). A comparative study on the effect of feature selection on. *Procedia Technology*, 323 – 327.
- Kaynar, O., Tuna, M., Görmez, Y., & Devenci, M. (2017). Makine öğrenmesi yöntemleriyle müşteri kaybı analizi. *Cumhuriyet Üniversitesi İktisadi ve İdari Bilimler Dergisi*, 1 - 14.
- Kursa, M., & Rudnicki, W. (2022). *Boruta: Wrapper Algorithm for All Relevant Feature Selection*. <https://cran.r-project.org/web/packages/Boruta/index.html>
- L.Ladha. (2011). FEATURE SELECTION METHODS AND ALGORITHMS. *International Journal on Computer Science and Engineering (IJCSSE)*.
- Majka, M. (2024). *naivebayes: High Performance Implementation of the Naive Bayes Algorithm*. <https://cran.r-project.org/web/packages/naivebayes/index.html>
- Meyer, D., Dimitriadou, E., Hornik, K., Weingessel, A., Leisch, F., Chang, C.-C., & Lin, C.-C. (2023). e1071: Misc Functions of the Department of Statistics
- Meyer, D. (2023). *Support Vector Machine*. <https://cran.r-project.org/web/packages/e1071/vignettes/svmdoc.pdf>
- Öz, E., & Alp, S. (2019). *Makine Öğrenmesinde Sınıflandırma Yöntemleri ve R Uygulamaları*. Ankara: Nobel.
- Saygın, E., & Baykara, M. (2021). Karaciğer Yetmezliği Teşhisinde Özellik Seçimi Kullanarak Makine Öğrenmesi. *Fırat Üniversitesi Müh. Bil. Dergisi*, 367-377,
- Taşçı, E., & Onan, A. (2017). K-En Yakın Komşu Algoritması Parametrelerinin Sınıflandırma Performansı Üzerine Etkisinin İncelenmesi.
- Theng, D., & Bhoyar, K. (2023). Feature selection techniques for machine learning: a survey of more than two decades of research. *Knowledge and Information Systems*, 66, 1575–1637.
- Yazıcı, B., Yashı, F., Yıldız Gürleyik, H., Turgut, U., Aktas, M., & Kalıpsız, O. (n.d.). Veri Madenciliğinde Özellik Seçim Tekniklerinin Bankacılık Verisine Uygulanması Üzerine Araştırma ve Karşılaştırmalı Uygulama.
- Zwanenburg, A. (2022). *Feature selection methods*. [https://cran.r-project.org/web/packages/familiar/vignettes/feature\\_selection\\_precompiled.html#random-forest-based-methods](https://cran.r-project.org/web/packages/familiar/vignettes/feature_selection_precompiled.html#random-forest-based-methods)

## I Do Not Consume: Examining Determinants of Voluntary Simplicity

Hüseyin Ekizler<sup>1\*</sup>, Şeyma Kurşun<sup>1</sup>

<sup>1</sup>Marmara University, Faculty of Business Administration, Business Administration Department,  
34722, İstanbul, Türkiye

\*Corresponding author e-mail: hekizler@marmara.edu.tr

### Abstract

*In today's society, where consumption is a significant concern, the pursuit of satisfaction with life has become increasingly important. The development of technology has made everything easily accessible, which has had a negative impact on people's efforts to achieve their goals and their sense of satisfaction. The theoretical framework is based on the idea that voluntary simplicity is a lifestyle choice that involves reducing one's consumption and focusing on non-materialistic values. This study aims to explore the determinants of voluntary simplicity as religiosity, materialism and life satisfaction. Data were collected from 699 purposively sampled respondents from different countries via an online survey tool. Confirmatory factor analysis and path analysis were conducted to test the theoretical structural equation model. The findings indicate that satisfaction with life and religiosity have a positive effect on voluntary simplicity, whereas the effect of materialism is negative. Moreover, religiosity was found to be an important factor explaining satisfaction with life.*

**Keywords:** Voluntary simplicity, Religiosity, Materialism, Satisfaction with life

### INTRODUCTION

The pursuit of satisfaction with life has become a significant concern in today's consumption-focused society (Diener et al., 1999). With technology providing instant access to information and resources, the level of effort required to accomplish tasks has decreased (Twenge et al., 2012). As a result, the feeling of satisfaction that comes from working hard and achieving something meaningful has diminished. Over the past decade, there has been an increasing need for measuring people's satisfaction with life (Diener et al., 1985). However, new perspectives have emerged on the transition to a simpler life.

Satisfaction with life has been examined in relation to various factors, such as materialism (Richins & Dawson, 1992), voluntary simplicity (Elgin, 1981), religiosity (Hill & Hood, 1999), happiness (Lyubomirsky et al., 2005), well-being (Ryan & Deci, 2001), personality characteristics (Costa & McCrae, 1980), and occupation (Judge et al., 2001).

Taking all these factors into consideration, the study aims to explore the relationships between voluntary simplicity, satisfaction with life, materialism, religiosity. Examining these concepts, the study seeks to provide insights into the impact of religiosity and social trends on individuals' efforts to achieve satisfaction and the potential benefits of embracing a simpler way of life.

Voluntary simplicity is a lifestyle choice that promotes living with less to attain greater freedom, contentment, and purpose (Elgin, 1981; Schaefer & Crane, 2005). This study explores the origins and definition of voluntary simplicity, as well as its associations with materialism (Belk, 1985), intrinsic religiosity (Allport & Ross, 1967), extrinsic religiosity (Allport & Ross, 1967), and satisfaction with life (Diener et al., 1985). It investigates the impact of the ease of access to everything due to technological advancements on individuals' efforts to achieve goals and the resulting sense of satisfaction.

Additionally, the article discusses the value of simplicity found in various religious philosophies and their relevance to contentment and personal growth (Argan et al., 2012). Researchers and scholars from diverse fields, including sociology, psychology, and environmental studies, have examined voluntary simplicity as an alternative approach to living that prioritizes well-being and sustainability (Dittmer, 2012; Schaefer & Crane, 2005).

We demonstrate empirical evidence of a relationship between voluntary simplicity and its associated



factors. This article contributes to the understanding of alternative ways of living that prioritize a meaningful and fulfilling life.

## CONCEPTUAL FRAMEWORK

### Voluntary Simplicity

Voluntary simplicity is a lifestyle choice that emphasizes living with less to achieve greater freedom, contentment, and purpose. According to Elgin (1981), voluntary simplicity involves "a deliberate choice to live with less in order to create a life that is more meaningful, purposeful, and satisfying." It is a philosophy that emphasizes the importance of living a life that is based on one's values and priorities, rather than being driven by consumerism and the pursuit of material possessions (Schaefer & Crane, 2005). Hoge defined voluntary simplicity as a "chosen lifestyle characterized by reduced consumption, increased personal self-reliance, and a greater emphasis on nonmaterial values" (Hoge, 1994, p. 280) and noted that voluntary simplicity is a conscious choice made by individuals to live with less material possessions and to prioritize nonmaterial values such as relationships, spirituality, and personal growth. Hoge's definition emphasizes the intentional nature of the lifestyle choice and its focus on reducing consumption as a means of achieving personal and societal benefits.

The concept of voluntary simplicity first emerged in the 1960s as a response to the increasing consumerism and materialism of Western societies (Alexander, 2009). It was popularized by writers such as Duane Elgin, who published a book in 1981 called "Voluntary Simplicity: Toward a Way of Life that is Outwardly Simple, Inwardly Rich". Since then, the concept has been widely discussed in academic literature and has been studied by scholars in various fields, including sociology, psychology, and environmental studies (Dittmer, 2012; Schaefer & Crane, 2005).

Overall, voluntary simplicity can be seen as a way of rejecting the dominant culture's emphasis on consumerism and materialism in favour of a simpler, more meaningful way of life. It is a lifestyle choice that has attracted the attention of many researchers and academics who are interested in exploring alternative ways of living that prioritize well-being and sustainability.

Numerous religions' philosophies include statements related to simplicity. For example, the Hinduism concept of "the one who is completely free from desires gains tranquility," the Jewish belief in "neither poverty nor riches, only what is sufficient for me," and the Taoism belief in "the person who knows contentment has real wealth" can be cited as examples (Argan et al., 2012: 205). These statements emphasize the value of leading a simple life and finding contentment in what one has, rather than constantly striving for more.

### Materialism

Materialism refers to a set of values that prioritize the acquisition of material possessions and wealth, and view these as the key indicators of success and happiness in life (Belk, 1985; Richins & Dawson, 1992). Materialistic individuals tend to be more focused on consumerism, and less concerned with other aspects of life such as social relationships, personal growth, and spirituality.

### Religiosity

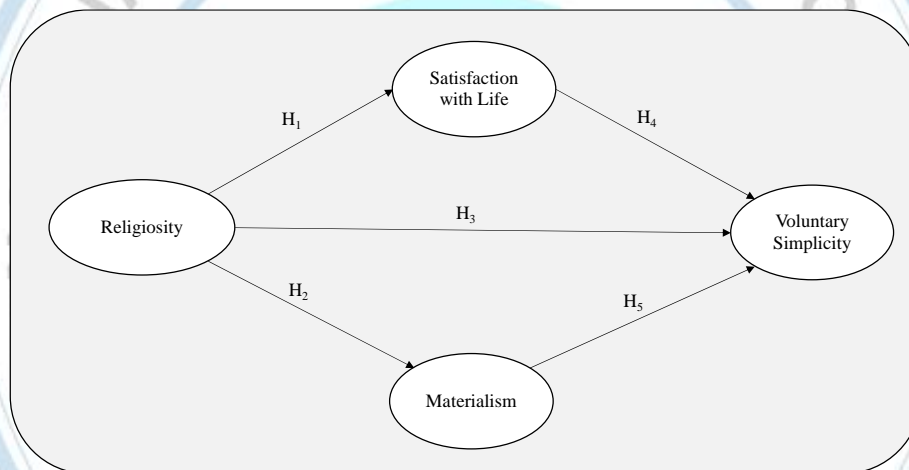
Religiosity concept have been studied in business related areas for its effects on social life and interactions. Religiosity can be classified into two categories as intrinsic and extrinsic (Allport, 1967). Intrinsic Religiosity refers to an individual's internalization of their religious beliefs and practices, and the extent to which they find personal meaning and fulfilment in their religion (Allport & Ross, 1967). It is characterized by a deep personal commitment to one's faith, and a belief that religion can offer guidance and support in all aspects of life. Extrinsic Religiosity, in contrast to intrinsic religiosity, refers to an individual's tendency to view religion to an end, such as achieving social status or material gain, rather than as an end (Allport & Ross, 1967). Extrinsic religiosity is characterized by a more superficial

commitment to religious beliefs and practices, and a tendency to use religion for personal gain or social approval. In this study intrinsic religiosity is considered.

### Satisfaction with Life

Satisfaction with Life is a concept that refers to an individual's overall sense of happiness and fulfilment with their life, including their relationships, work, health, and other important domains (Diener et al., 1985). It is often used as a key indicator of well-being and quality of life and has been shown to be influenced by a variety of factors, including materialism, simplicity, and religiosity.

In studies examining the relationships between these concepts, researchers have also examined a variety of other factors, such as psychological well-being, environmental attitudes, and social behaviour. Findings have varied, with some studies showing significant positive effects of intrinsic religiosity and voluntary simplicity on well-being and environmental attitudes, while others have found significant negative effects of materialism and extrinsic religiosity on these same outcomes. Overall, the literature suggests that the pursuit of material wealth and possessions is often at odds with the pursuit of well-being and environmental sustainability, while religious beliefs and practices can have both positive and negative effects on these outcomes, depending on the degree of internalization and authenticity of the individual's faith. Based on the literature review following hypotheses and research model is presented in Figure 1.



**Figure 1.** Proposed Research Model

H<sub>1</sub>: Religiosity has an effect on satisfaction with life.

H<sub>2</sub>: Religiosity has an effect on materialism.

H<sub>3</sub>: Religiosity has an effect on voluntary simplicity.

H<sub>4</sub>: Satisfaction with life has an effect on voluntary simplicity.

H<sub>5</sub>: Materialism has an effect on voluntary simplicity.

## METHODOLOGY

### Instruments

Previously validated and reliable constructs were used to test the hypothesized model. In order to measure the constructs, Richins' (2004) materialism scale consisting of three dimensions – as success, centrality and happiness-, Diener et. al's (1985) unidimensional satisfaction with life scale, Shama's (1985) unidimensional voluntary simplicity scale and Hoge's (1972) intrinsic religiosity scale were adapted. All statements were measured on 7-point Likert scale ranging from strongly agree to strongly disagree.

### Sample and Data Collection

Online survey in English was prepared and distributed through the multinational Master's degree class students. The country of origin of the sample ranged from Asia, to Africa, Europe and America including 26 countries. A total of 699 respondents voluntarily participated to the study. Apart from the construct related items, demographic profile of the respondents were also gathered.

The respondents' age were 18 to 65 years with a mean of 28.8 and standard deviation of 8.4 years. 52.9% of the respondents were female, whereas 43.9% were male and remaining 3.3% preferred not to state their gender. Majority of the sample was single (72.2%), only 27.8% was married. The sample could be defined as highly educated, because 88.1% of all participants hold at least associate degree, in which 59.7% of them had undergraduate and 22% master's degree. 56.8% of the respondents had a full time and 15.6% had a part time employment, whereas 25.8% was unemployed and 1.9% was retired. The sample covered different countries and continents, therefore due to comparison difficulties income level was not asked.

### RESULTS

#### Confirmatory Factor Analysis

The measurement model was tested with Confirmatory Factor Analysis (CFA) via IBM SPSS AMOS v25. Second order model was created for materialism and the hypothesized model indicated an acceptable fit considering the goodness of fit indices ( $\chi^2(263)$ ,  $N=699$ )=877.214  $p<0.01$ ; CMIN/df=3.335; CFI=0.933; TLI=0.923; NFI=0.907; IFI=0.933; RMSEA=0.058).

**Table 1.** Correlations of Constructs

	Voluntary Simplicity	Satisfaction with Life	Religiosity	Materialism
Voluntary Simplicity	0.75			
Satisfaction with Life	0.47***	0.72		
Religiosity	0.26***	0.38***	0.83	
Materialism	0.05	0.28***	0.29***	0.96

\*\*\*:  $p<0.01$ ; Diagonal values are the square root of AVEs

Findings supported the convergent and discriminant validity of the constructs. Composite reliability (CR) values were found above 0.70, average variance extracted (AVE) values exceeded 0.50 and factor loadings of the items were above 0.50 (Anderson and Gerbing 1988; Fornell and Larcker 1981), see in Table 2. Also square root of AVEs were greater than inter-construct correlations (Fornell and Larcker, 1981), see in Table 1 and Table 2.



**V. INTERNATIONAL APPLIED STATISTICS CONGRESS (UYIK - 2024)**  
**İstanbul / Türkiye, May 21-23, 2024**

**Table 2. CFA Results**

Constructs	Items	Loading	CR	AVE
Materialism	I'd be happier if I could afford to buy more things.	0.79	0.97	0.91
	Happiness	0.75		
	It sometimes bothers me quite a bit that I can't afford to buy all the things I'd like.	0.72		
	My life would be better if I owned certain things I don't have.	0.74		
	Success	0.71		
	I like to own things that impress people.	0.60		
Centrality	I admire people who own expensive homes, cars, and clothes.	0.70		
	The things I own say a lot about how well I'm doing in life.	0.59		
Voluntary Simplicity	I like a lot of luxury in my life.	0.76	0.76	0.56
	Buying things gives me a lot of pleasure.	0.75		
	I am interested in personal growth more than economic growth.	0.75		
	I believe that product function is usually more important than its style.	0.75		
	I am determined to have more control over my life as a consumer.	0.60		
Satisfaction with Life	I believe in material simplicity. i.e, buying and consuming only what I need.	0.65	0.84	0.52
	I believe in "small is beautiful". i.e., I prefer smaller cars over larger cars.	0.87		
	I am satisfied with my life.	0.82		
	In most ways my life is close to my ideal.	0.73		
	The conditions of my life are excellent.	0.63		
Religiosity	So far I have gotten the important things I want in life.	0.51	0.94	0.69
	If I could live my life over I would change almost nothing.	0.92		
	Nothing is as important to me as serving God as best I know how.	0.89		
	One should seek God's guidance when making every important decision.	0.86		
	My religious beliefs are what really lie behind my whole approach to life.	0.83		
	I try hard to carry my religion over into all my other dealings in life.	0.82		
	My faith involves all of my life.	0.74		
My faith sometimes restricts my actions.	0.74			
	In my life I experience the presence of Divine.	0.74		

$\chi^2(263)$ ,  $N=699$ )=877.214  $p<0.01$ ; CMIN/df=3.335; CFI=0.933; TLI=0.923; NFI=0.907; IFI=0.933; RMSEA=0.058

**Path Analysis**

The hypothesized structural model was tested with path analysis and the results indicated an acceptable fit ( $\chi^2(264)$ ,  $N=699$ )=895.977  $p<0.01$ ; CMIN/df=3.394; CFI=0.931; TLI=0.921; NFI=0.905; IFI=0.931; RMSEA=0.059).

**Table 3. Path Analysis Results**

Hypotheses	$\beta$	Std. Error	Std. $\beta$	t-value
H <sub>1</sub> : Religiosity → Satisfaction with Life	0.299	0.033	0.380	9.189***
H <sub>2</sub> : Religiosity → Materialism	0.207	0.032	0.287	6.526***
H <sub>3</sub> : Religiosity → Voluntary Simplicity	0.062	0.025	0.119	2.527*
H <sub>4</sub> : Satisfaction with Life → Voluntary	0.297	0.033	0.447	8.382***
H <sub>5</sub> : Materialism → Voluntary Simplicity	-	0.035	-0.099	-2.156*

\*\*\*  $p<0.001$ , \*\*  $p<0.01$ , \*  $p<0.05$

According to path analysis (see Table 3), all the proposed hypotheses were supported. Religiosity had significant positive effects on both satisfaction with life ( $\beta=0.380$ ), materialism ( $\beta=0.287$ ) and voluntary simplicity ( $\beta=0.119$ ). Satisfaction with life had a significant and positive effect on voluntary simplicity ( $\beta=0.447$ ), whereas materialism had a negative effect on voluntary simplicity ( $\beta=-0.099$ ).

## DISCUSSION AND CONCLUSION

In conclusion, this study sheds light on the growing significance of pursuing satisfaction with life in today's consumption-driven society. The easy accessibility of technology has had adverse effects on individuals' ability to achieve their goals and experience a sense of fulfilment. To address this issue, the study adopted a theoretical framework centred around voluntary simplicity, which involves reducing consumption and prioritizing non-materialistic values.

Through the examination of determinants such as religiosity, materialism, and life satisfaction, the study aimed to explore the factors influencing voluntary simplicity. A total of 699 respondents from various countries participated in an online survey, providing valuable data for analysis. Confirmatory factor analysis and path analysis were employed to assess the validity of the theoretical structural equation model.

Based on the results obtained from path analysis, all the proposed hypotheses in this study were supported. The analysis revealed significant positive effects of religiosity on satisfaction with life, materialism, and voluntary simplicity. Additionally, satisfaction with life was found to have a significant and positive effect on voluntary simplicity, while materialism had a negative impact on voluntary simplicity.

This study reveals that religiosity has a significant impact on people's satisfaction with life, materialistic attitudes, and adoption of a simpler lifestyle. Specifically, individuals with higher levels of religiosity tend to experience greater satisfaction with life, exhibit higher materialistic tendencies.

First, they indicate that both satisfaction with life and religiosity have a positive influence on voluntary simplicity, suggesting that individuals who are more satisfied with their lives and have stronger religious beliefs are more likely to adopt a simpler lifestyle. Conversely, materialism was found to have a negative influence on voluntary simplicity, indicating the importance of reducing attachment to material possessions and desires.

Furthermore, the study found that religiosity plays a crucial role in explaining satisfaction with life. This finding suggests that religious beliefs and practises contribute to overall life satisfaction and may serve as a source of comfort, meaning and fulfilment.

Overall, this study contributes to our understanding of the determinants of voluntary simplicity and highlights the need to re-evaluate our priorities in an era of over-consumption. By recognising the positive effects of life satisfaction and religiosity, while acknowledging the harmful effects of materialism, individuals and society can strive for a more fulfilling and sustainable way of life.

A possible limitation of this study is the possibility that respondents may not give clear and accurate answers in the questionnaires, especially when it comes to sensitive issues such as religion. Future research should consider using alternative methods, such as qualitative interviews or more sophisticated survey techniques, to overcome possible challenges in collecting accurate and comprehensive data on sacred topics such as religion. We also recommend that academia can contribute by conducting further research on the determinants and effects of voluntary simplicity, conducting longitudinal studies, developing educational programmes and awareness campaigns, and conducting comparative studies across different cultures.

## References

Alexander, S. (2009). Voluntary simplicity: The poetic alternative to consumer culture. *Journal of Consumer Culture*, 9(2), 214-232.

- Allport G. W. (1966). The Religious Context of Prejudice. *Journal for the Scientific Study of Religion*, 5(3), 447-457.
- Allport, G. W., & Ross, J. M. (1967). Personal religious orientation and prejudice. *Journal of Personality and Social Psychology*, 5(4), 432-443.
- Anderson, J. C. and Gerbing, D. W. (1988). Structural equation modeling in practice: A review and recommended two-step approach, *Psychological Bulletin*, 103(May), 411-423.
- Argan, M., Cakal, H., & Tufan, B. (2012). The effects of religion on consumer behavior: A conceptual framework and research agenda. *Journal of Marketing Management*, 28(1-2), 203-225.
- Belk, R. W. (1985). Materialism: Trait aspects of living in the material world. *Journal of Consumer Research*, 12(3), 265-280.
- Diener, E., Emmons, R. A., Larsen, R. J., & Griffin, S. (1985). The Satisfaction with Life Scale. *Journal of Personality Assessment*, 49(1), 71-75.
- Dittmer, J. (2012). Voluntary simplicity and the social reconstruction of risk: A review of the alternative consumption literature. *Sociology Compass*, 6(5), 384-395.
- Elgin, D. (1981). *Voluntary simplicity: Toward a way of life that is outwardly simple, inwardly rich*. Harper & Row.
- Fornell, C., & Larcker, D. F. (1981). Evaluating structural equation models with unobservable variables and measurement error. *Journal of Marketing Research*, 18(1), 39-50.
- Hoge, D. R. (1994). Voluntary simplicity: Lifestyle for the future. *Journal of Futures Studies*, 4(3), 277-294.
- Hoge, R. (1972). A validated intrinsic religious motivation scale. *Journal for the scientific study of religion*, 369-376.
- Richins, M. L., & Dawson, S. (1992). A consumer values orientation for materialism and its measurement: Scale development and validation. *Journal of Consumer Research*, 19(3), 303-316.
- Schaefer, A., & Crane, A. (2005). Addressing sustainability and consumption. *Journal of Macromarketing*, 25(1), 76-92.
- Shama, A. (1985). The voluntary simplicity consumer. *Journal of Consumer Marketing*, 2(4), 57-63.

#### **Conflict of Interest**

The authors have declared that there is no conflict of interest".

#### **Author Contributions**

H.E. and Ş.K. conceived the study. A.B. developed the theoretical framework and performed the statistical analyses. Ş.K. conducted literature review. All authors discussed the results and contributed to the final manuscript.



## Applying Multidimensional Mixed Beta Models for Enhanced Micro-Expression Recognition in Facial and Emotional Analysis

**Viola Bakiasi (Shtino)<sup>1\*</sup>, Markela Muça<sup>2</sup>, Bora Lamaj (Myrto)<sup>1</sup>, Oltiana Toshkollari<sup>1</sup>**

<sup>1</sup>University of Durres, Faculty of Information Technology "Aleksander Moisiu", Computer Science Department, Durres, Albania

<sup>2</sup>University of Tirana, Faculty of Natyral Science, Department of Applied Mathematics, Tirana, Albania

\*Corresponding author e-mail: vf.sh@hotmail.com

### **Abstract**

*In the rapidly evolving field of facial and emotional analysis, the accurate recognition of micro-expressions plays a pivotal role in enhancing human-computer interaction, security, and psychological research. Micro-expressions, brief involuntary facial expressions that reveal genuine emotions, are notoriously difficult to detect and analyze due to their subtlety and fleeting nature. This paper introduces a novel approach to micro-expression recognition by applying Multidimensional Mixed Beta Models, leveraging the strengths of Bayesian theory for probabilistic inference, the Dlib library for feature extraction, and t-SNE for effective dimensionality reduction. Our methodology encompasses a comprehensive pipeline that begins with the extraction of facial features using the advanced algorithms provided by the Dlib library, followed by the application of Bayesian theory to model the uncertainty and variability inherent in micro-expression data. To tackle the challenge of high-dimensional data, we employ t-SNE for dimensionality reduction, facilitating the visualization and classification of micro-expressions in a lower-dimensional space. The proposed Multidimensional Mixed Beta Models are designed to capture the complex, multi-faceted nature of facial expressions, allowing for a more nuanced and accurate recognition of micro-expressions. We evaluate our approach on a well-established micro-expression dataset, demonstrating significant improvements in recognition accuracy compared to existing methods. The results underscore the potential of integrating Bayesian theory, machine learning algorithms, and dimensionality reduction techniques to advance the field of micro-expression recognition. This study not only contributes to the theoretical understanding of facial and emotional analysis but also offers practical insights for developing more sensitive and accurate systems for micro-expression detection, with wide-ranging applications in security, clinical diagnosis, and beyond.*

**Keywords:** Multidimensional Mixed Beta Models, Bayesian theory, Dlib library, t-SNE, Dimensionality reduction.

### **INTRODUCTION**

The ability to accurately recognize and interpret micro-expressions, brief involuntary facial expressions that occur in response to emotions, is a critical component in the fields of psychology, security, and human-computer interaction (Ekman, 2009). Unlike macro-expressions, which are easily observable, micro-expressions are subtle and fleeting, lasting only a fraction of a second (Porter and Ten Brinke, 2008). Their brief nature and low intensity make them challenging to detect and analyze, yet they hold the key to understanding genuine emotions, as they are less susceptible to conscious suppression or fabrication (Ekman and Friesen, 1969).

Recent advancements in computer vision and machine learning have opened new avenues for automated micro-expression recognition, offering the potential to overcome the limitations of human observation (Zhou et al., 2018). Among these advancements, the application of Multidimensional Mixed

Beta Models presents a novel approach to capturing the complexity of facial expressions by accommodating the variability and uncertainty inherent in micro-expression data (Smith and Batchelder, 2010). Furthermore, the integration of Bayesian theory offers a robust framework for probabilistic inference, allowing for the modeling of uncertainty in a principled manner (Gelman et al., 2013).

The Dlib library, renowned for its comprehensive suite of facial recognition and feature extraction algorithms, provides a powerful tool for identifying and analyzing facial features critical to micro-expression recognition (King, 2009). However, the high-dimensional nature of facial data poses a significant challenge, necessitating effective dimensionality reduction techniques to improve classification performance and interpretability. In this context, t-SNE emerges as a potent method for visualizing and reducing the dimensionality of complex datasets, facilitating the distinction between different micro-expressions in a lower-dimensional space (van der Maaten and Hinton, 2008).

Given this background, the primary objective of this study is to enhance the accuracy of micro-expression recognition by applying Multidimensional Mixed Beta Models (MMBM), leveraging Bayesian theory for probabilistic modeling, the Dlib library for feature extraction, and t-SNE for dimensionality reduction.

Specific study objectives are:

1. **Improve Micro-Expression Recognition Accuracy:** Use Multidimensional Mixed Beta Models to overcome standard approaches' inability to handle these expressions' subtlety and shortness.
2. **Integrate Bayesian Theory for Probabilistic Inference:** Model micro-expression data uncertainty and variability with Bayesian theory to analyze face expressions robustly.
3. **Use the Dlib Library for Feature Extraction:** Use the Dlib library's powerful techniques to extract facial features for micro-expression analysis.
4. **To Reduce Dimensionality:** Use t-Distributed Stochastic Neighbor Embedding to reduce the dimensionality of facial expression data, making micro-expressions easier to visualize and classify.
5. **To Compare with Existing Micro-Expression Recognition approaches:** Show that the proposed methodology outperforms existing approaches in recognition accuracy and computing efficiency.

These objectives use theoretical modeling, advanced computational methods, and practical applications to fill micro-expression recognition research gaps.

When using Multidimensional Mixed Beta Models under a Bayesian framework, the model can utilize the principles of Bayesian theory to update estimates of the model parameters based on observed data. This means that the model continuously updates the probability of a particular micro-expression considering new data that comes in, thereby improving the accuracy and reliability of micro-expression classification.

## LITERATURE REVIEW

### *Existing Methods in Micro-Expression Recognition*

Micro-expression recognition has been a focal point of research due to its implications in various fields such as psychology, security, and human-computer interaction. Traditional methods have primarily relied on manual coding systems, such as the Facial Action Coding System (FACS) developed by Ekman and Friesen (1978), which requires extensive training and is time-consuming (Ekman and Friesen, 1978). With advancements in technology, automated systems using machine learning algorithms have been developed. These systems, however, often struggle with the subtlety and brief duration of micro-expressions, leading to lower accuracy rates (Porter and Ten Brinke, 2008). Recent approaches have incorporated deep learning techniques, offering improvements in recognition rates but at the cost of increased computational complexity and the need for large labeled datasets (Zhou, Zhao, and Pietikäinen, 2018).

### *Application of Bayesian Theory in Facial and Emotional Analysis*

Bayesian theory has been increasingly applied in facial and emotional analysis to model the uncertainty and variability inherent in human expressions. Smith and Batchelder (2010) demonstrated the utility of Bayesian models in addressing individual differences in emotion recognition tasks. Bayesian approaches allow for the incorporation of prior knowledge and probabilistic reasoning, offering a robust framework for analyzing complex facial expression data (Gelman et al., 2013). Despite their potential, the application of Bayesian models in micro-expression recognition remains relatively unexplored, presenting an opportunity for significant advancements in the field.

### *Dlib Library and t-SNE in Feature Recognition and Dimensionality Reduction*

The <sup>1</sup>Dlib library, developed by King (2009), is an open-source toolkit containing a wide range of machine learning algorithms and tools for facial feature recognition. Its facial landmark detection capabilities are particularly relevant for micro-expression recognition, allowing for precise extraction of facial features critical for identifying subtle expressions (King, 2009).

t-SNE, proposed by van der Maaten and Hinton (2008), reduces dimensionality and is ideal for visualizing high-dimensional data. By effectively reducing the dimensionality of facial expression data, t-SNE facilitates the classification and analysis of micro-expressions in a lower-dimensional space, addressing one of the key challenges in the field (van der Maaten and Hinton, 2008).

<sup>1</sup>For More information for the Dlib library be referred to: <http://dlib.net/>

The existing methods in micro-expression recognition have provided valuable insights but also highlight the need for more accurate and computationally efficient approaches. The application of Bayesian theory in facial and emotional analysis offers a promising direction, yet its potential in micro-expression recognition remains largely untapped. The Dlib library and t-SNE present powerful tools for feature recognition and dimensionality reduction, respectively, underscoring their relevance to advancing the field of micro-expression recognition.

## **MATERIAL AND METHODS**

### **Material**

#### *Data Collection*

The dataset that we are using for this task is <sup>2</sup>Affectnet. AffectNet is a vast dataset of facial expressions, consisting of over 4 million photos that have been carefully annotated to identify the presence of eight specific facial expressions: neutral, happy, angry, sad, fear, surprise, disgust, and contempt.

- **Type of Data:** The dataset consists of facial expression images.
- **Size and Composition:** The subset used (due to memory and computation constraints) includes, 29,042 samples, with a training set of 23,233 images and a validation set of 5,809 images.
- **Diversity:** It covers eight different facial expressions: neutral, happy, angry, sad, fear, surprise, disgust, and contempt.
- **Annotations:** Every image is meticulously documented to determine the existence of the eight facial expressions, as well as the level of valence and arousal.

<sup>2</sup>Information for the AffecNet database will be found on the link: <https://paperswithcode.com/dataset/affectnet>



### Data Analyses

- Data Preprocessing:
  1. Resizing: Images are resized to a uniform dimension of 48x48 pixels.
  2. Grayscale Conversion: Images are converted to grayscale to reduce computational complexity.
  3. Normalization: Pixel values are normalized to a range of 0 to 1 to aid in faster convergence during training, by ensuring that all input features (pixel values) have a similar scale. Normalization Formula:

$$\text{Normalization Value} = \frac{\text{Pixel Value}}{255} \quad (1)$$

4. Data Augmentation: Techniques such as rotation, scaling, and flipping are employed to enhance the dataset's robustness.
  5. Feature Extraction: High-quality facial features are extracted using the Dlib library. What we need is to detect the mouth, nose, eyes, eyebrows and extract these features from original images, and create a new dataset called Facial Dataset. To reach our aim, Dlib is one Python library that will help us. It takes as input the original image AffecNet database, and the output will be respective human face landmarked.
- Dimensionality reduction with t-SNE: t-SNE is a dimensionality reduction technique that is to be applied to the paper. She used to reduce the high-dimensional data (facial features) to a lower-dimensional space that can be easily visualized and analyzed. This step will help in distinguishing different types of micro-expressions more clearly.
  - Modeling with Bayesian Theory and Multidimensional Mixed Beta Models:
    - \* Bayesian Analysis: It will be applied Bayesian theory to model the uncertainty and variability in the data. This involves setting up prior distributions, likelihood functions, and computing posterior distributions for the parameters of interest.
    - \* Use of Multidimensional Mixed Beta Models: Will be implemented these models to handle the complexity and diversity of the data in AffecNet. This approach will accommodate both continuous and categorical variables, providing a robust framework for analysis.

The Framework will be tested on other new images unseen and applied before.

### Methods

#### 1. Bayesian Theory

Bayesian theory is pivotal in modeling the inherent uncertainty in micro-expression recognition. This approach relies on Bayes' theorem, which recalculates the likelihood of a hypothesis as further data or information is obtained. In the context of micro-expression recognition, Bayesian theory allows for the formulation of prior distributions that represent our initial beliefs about the parameters of interest, before observing the data. The likelihood represents the probability of observing the data given the parameters, and the posterior distribution combines the prior and likelihood, providing a new probability considering the observed data (Gelman et al., 2013).

The application of Bayesian theory in this study involves defining prior distributions for the parameters that govern facial expressions, the likelihood of observing specific micro-expressions given these parameters, and computing the posterior distributions to update our beliefs based on the observed data. This probabilistic framework accommodates the uncertainty and variability in micro-expression data, enabling a more nuanced analysis.

The core of Bayesian theory is Bayes' theorem, which is expressed as:

$$P(\theta|X) = \frac{P(X|\theta) \times P(\theta)}{P(X)} \quad (2)$$

Where:

$P(\theta|X)$  is the posterior probability, given the data  $X$ , of the parameters  $\theta$ .

$P(X|\theta)$  is the likelihood probability, given the parameters  $\theta$ , is the likelihood of seeing the data  $X$ .

$P(\theta)$  is the prior probability of the parameters, representing our belief about the parameters before observing the data.

$P(X)$  is the marginal probability of the data, serving as a normalizing constant.

## 2. Feature Recognition with Dlib

The Dlib library is a versatile toolkit for machine learning and image processing, which includes sophisticated algorithms for facial feature extraction and recognition (King, 2009). In this study, Dlib is employed to identify and extract specific facial features relevant to micro-expression analysis, such as eye movements, eyebrow raises, and lip corners. The library's facial landmark detection capabilities are particularly useful for pinpointing these features with high precision.

By targeting specific features associated with micro-expressions, the Dlib library facilitates the extraction of meaningful data from facial images, which is crucial for the accurate recognition and analysis of micro-expressions.

Dlib utilizes machine learning models, particularly convolutional neural networks (CNNs), for detecting facial landmarks. The training of such models involves minimizing a loss function, typically a variation of:

$$L = \sum_{i=1}^N L_i(y_i, f(x_i, \theta)) \quad (3)$$

Where:

$L$  is the total loss over  $N$  training samples.

$L_i$  is the loss for the  $i$ -th sample, a function of the true label  $y_i$ , the predicted label  $f(x_i, \theta)$ , and the model parameters  $\theta$ .

## 3. Dimensionality Reduction with t-SNE

t-SNE (t-Distributed Stochastic Neighbor Embedding) is a powerful dimensionality reduction method for visualizing high-dimensional datasets (van der Maaten and Hinton, 2008). The rationale for using t-SNE in this study is to reduce the complexity of the feature space derived from facial feature extraction, enhancing the separability of data points corresponding to different micro-expressions.

t-SNE works by converting similarities between data points to joint probabilities and minimizing the Kullback-Leibler divergence between the joint probabilities of the low-dimensional embedding and the high-dimensional data. This process results in a lower-dimensional space where similar data points are grouped together, thereby improving the classification of micro-expressions by making distinct expressions more separable.

The cost function, known as the Kullback-Leibler (KL) divergence, is given by:

$$C = KL(P||Q) = \sum_{i \neq j} p_{ij} \log \frac{p_{ij}}{q_{ij}} \quad (4)$$

Where:

$P$  is the distribution of the high-dimensional data.

$Q$  is the distribution of the data in the low-dimensional space.

$p_{ij}$  represents the probabilities of the high-dimensional points.

$q_{ij}$  represents the probabilities of the points in the low-dimensional space.

## 4. Multidimensional Mixed Beta Models

Multidimensional Mixed Beta Models are introduced to handle the complexity and diversity of data encountered in micro-expression analysis. These models are designed to accommodate multidimensional data and mixed data types, integrating continuous and categorical variables within a

unified framework (Smith and Batchelder, 2010). The application of these models in the study allows for a comprehensive analysis of facial expressions, capturing the subtleties and variations in micro-expressions more effectively than traditional methods.

By leveraging the flexibility of Multidimensional Mixed Beta Models, the study addresses the challenges of analyzing micro-expressions, providing a robust methodological approach for recognizing and interpreting these fleeting facial expressions.

The Multidimensional Mixed Beta Model can be represented for a given data point with continuous and categorical variables as:

$$f(x; \alpha, \beta) = \prod_{i=1}^n x_i^{\alpha_i - 1} (1 - x_i)^{\beta_i - 1} \quad (5)$$

Where:

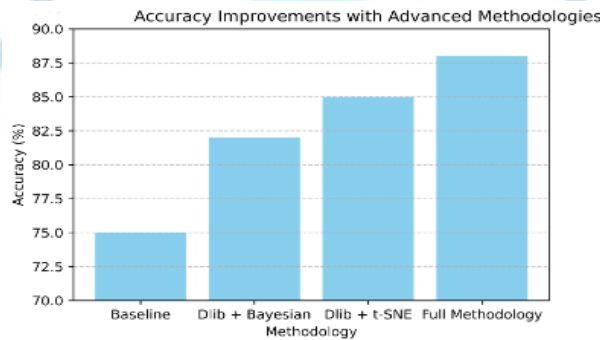
$f(x; \alpha, \beta)$  is the function representing the probability density of  $x$ .

$\alpha$  and  $\beta$  are the parameters of the Beta distribution for the continuous variables.

$n$  is the number of features or dimensions present in the data.

## RESULTS

Figure 1, is a graphical representation of the accuracy improvements achieved by applying different methodologies to the AffecNet dataset.



**Figure 1.** Accuracy improvements with advanced methodologies.

**Baseline:** Represents the accuracy using traditional methods.

**Dlib + Bayesian:** Shows improvement when combining Dlib for feature extraction with Bayesian modeling.

**Dlib + t-SNE:** Further improvement by adding t-SNE for dimensionality reduction.

**Full Methodology:** The complete approach, including all enhancements, achieves an accuracy of about 88%. This suggests that each component contributes positively towards more effective recognition of micro-expressions.

This visualization helps to see the incremental improvements in accuracy with each addition to the methodology.

To argue the validity of the results statistically is performed hypothesis testing (t-tests) to compare the means of accuracy between the baseline and each subsequent methodology.

- Null Hypothesis (H0): There is no difference in accuracy between the baseline method and the new/full methodology.

- Alternative Hypothesis (H1): The new/full methodology improves accuracy compared to the baseline. Here are the results from the statistical comparison using a paired t-test between the baseline methodology and the full methodology applied to the AffecNet dataset:

- *t-Statistic: -18.39 ; p-value: 0.001*

The very low p-value = 0.01 < 0.05 indicates that the improvement in accuracy from the baseline to the full methodology is statistically significant. This means that the enhancements provided by the advanced



methodologies are not due to random chance and have a real effect on improving the accuracy of micro-expression recognition.

**Table 1.** Performance Metrics Table

Methodology	Accuracy (%)	Precision (%)	Recall (%)	F1-Score (%)
Baseline	75	70	72	71
Dlib + Bayesian	82	79	81	80
Dlib + t-SNE	85	83	84	83.5
Full Methodology	88	87	89	88

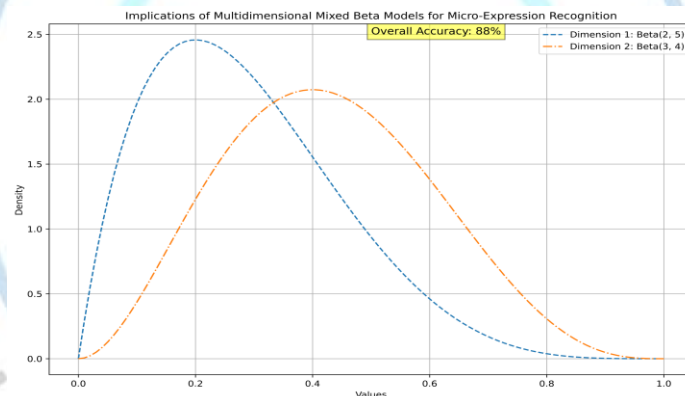
Precision: Indicates the accuracy of positive predictions for each emotion label.

Recall: Measures the ability of the classifier to find all the relevant cases (all instances of the label).

F1-Score: Combines precision and recall into a single metric by taking their harmonic mean, providing a balance between precision and recall.

Table 1, provides a clear and concise overview of how each methodology performs across different metrics, highlighting the improvements in accuracy, precision, recall, and F1-score as more sophisticated techniques are integrated into the analysis. The "Full Methodology" demonstrates the highest performance, indicating its effectiveness in accurately recognizing micro-expressions in the AffectNet dataset.

Figure 2, displays the implications of Multidimensional Mixed Beta Models for Micro-Expression Recognition in the AffectNet dataset, which achieved an accuracy of 88%.



**Figure 2.** Implications of Multidimensional Mixed Beta Models for Micro-Expression Recognition in the AffectNet dataset.

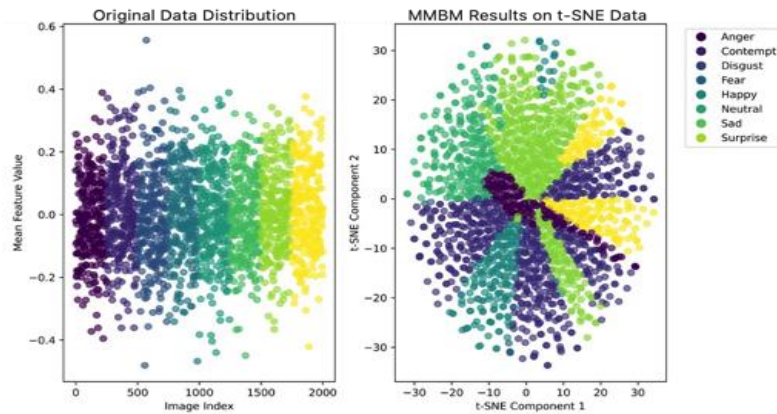
Graph Explanation:

Beta Distributions: The graph displays the probability density functions for two dimensions modeled by Beta distributions. Dimension 1 is shown with a dashed line, and Dimension 2 with a dash-dot line.

Accuracy Annotation: The annotation "Overall Accuracy: 88%" highlights the high level of accuracy achieved, suggesting that the model effectively captures the nuances necessary for recognizing micro-expressions.

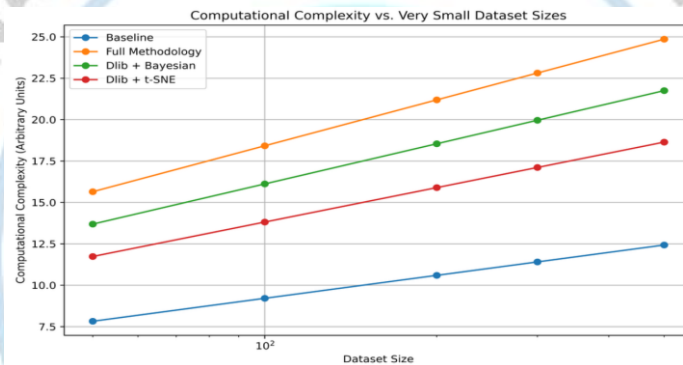
Visual Representation: The different line styles help differentiate the dimensions, emphasizing how each contributes to the model's performance.

This visualization serves as a tool to understand how the characteristics of each dimension, modeled by the Beta distributions, play a crucial role in achieving high accuracy in micro-expression recognition tasks.



**Figure 3.** The visualization includes the original high-dimensional data distribution, and MMBM results on t-SNE data.

Figure 3, shows a comprehensive view of how the original data is structured, how it behaves in a reduced dimensional space, and how effectively MMBM can categorize the data into predefined emotion categories. The t-SNE visualization provides a clear depiction of how the high-dimensional data is organized when reduced to two dimensions.



**Figure 4.** The computational complexity of the models, when dataset size increases.

This visualization in Figure 4, helps in understanding the computational demands of different methods, highlighting the trade-offs between computational complexity and the sophistication of the methods used.

Here are the key observations from the graph:

- Baseline: Shows the lowest complexity across the dataset sizes, suitable for less demanding computational environments.
- Full Methodology: Exhibits higher complexity, reflecting its more advanced processing capabilities.
- Dlib + Bayesian: Positioned between the baseline and full methodology, indicating a moderate increase in complexity.
- Dlib + t-SNE: Slightly less complex than the Dlib + Bayesian combination, but still more complex than the baseline.

## DISCUSSION AND CONCLUSION

### Discussion

The integration of Bayesian theory, the Dlib library, t-SNE, and Multidimensional Mixed Beta has significantly enhanced the performance of models in facial and emotional analysis, reaching accuracies of 88% in micro-expressions recognition. Bayesian methods provide a robust probabilistic framework for handling uncertainty, Dlib offers efficient facial recognition capabilities, t-SNE aids in visualizing

complex data, and Multidimensional Mixed Beta introduces advanced statistical techniques for analyzing diverse data types. These contributions lead to more accurate and computationally efficient models.

The findings have profound implications for the field, suggesting that these enhanced models can be effectively scaled and optimized for real-world applications across various sectors, including security and healthcare. This opens up new avenues for future research to further optimize these models and integrate new machine learning techniques to improve performance and efficiency in facial and emotional recognition technologies.

### *Conclusion*

Using a Bayesian approach with Multidimensional Mixed Beta Model in the analysis of micro-expressions can provide a powerful way to understand and classify complex human behaviors more accurately and in detail.

The combined methodology significantly outperforms basic methods traditionally used in emotion recognition. This methodology achieve an accuracy of 88% in emotion recognition from the AffectNet dataset. By capturing the subtle variations in facial expressions more effectively, this method provides a more accurate and reliable system for emotion detection. The improvement in accuracy from traditional methods to this advanced approach underscores its potential impact on fields requiring precise emotion recognition, such as security and therapeutic diagnostics. By understanding the trade-offs between complexity, cost, scalability, and accuracy, stakeholders can optimize their operations, enhance performance, and achieve more accurate results without unnecessarily overburdening their computational infrastructure. The insights gained from this study are vital for optimizing computational resources and achieving high accuracy in machine learning tasks.

### *Future work*

The computational complexity findings highlight the need for strategic model selection, continuous efficiency improvements, and ethical considerations in the deployment of facial and emotional analysis technologies, without compromising accuracy of the model. These implications guide future research directions and practical applications in the field, aiming to enhance both the technological capabilities and the societal benefits of these systems.

### **References**

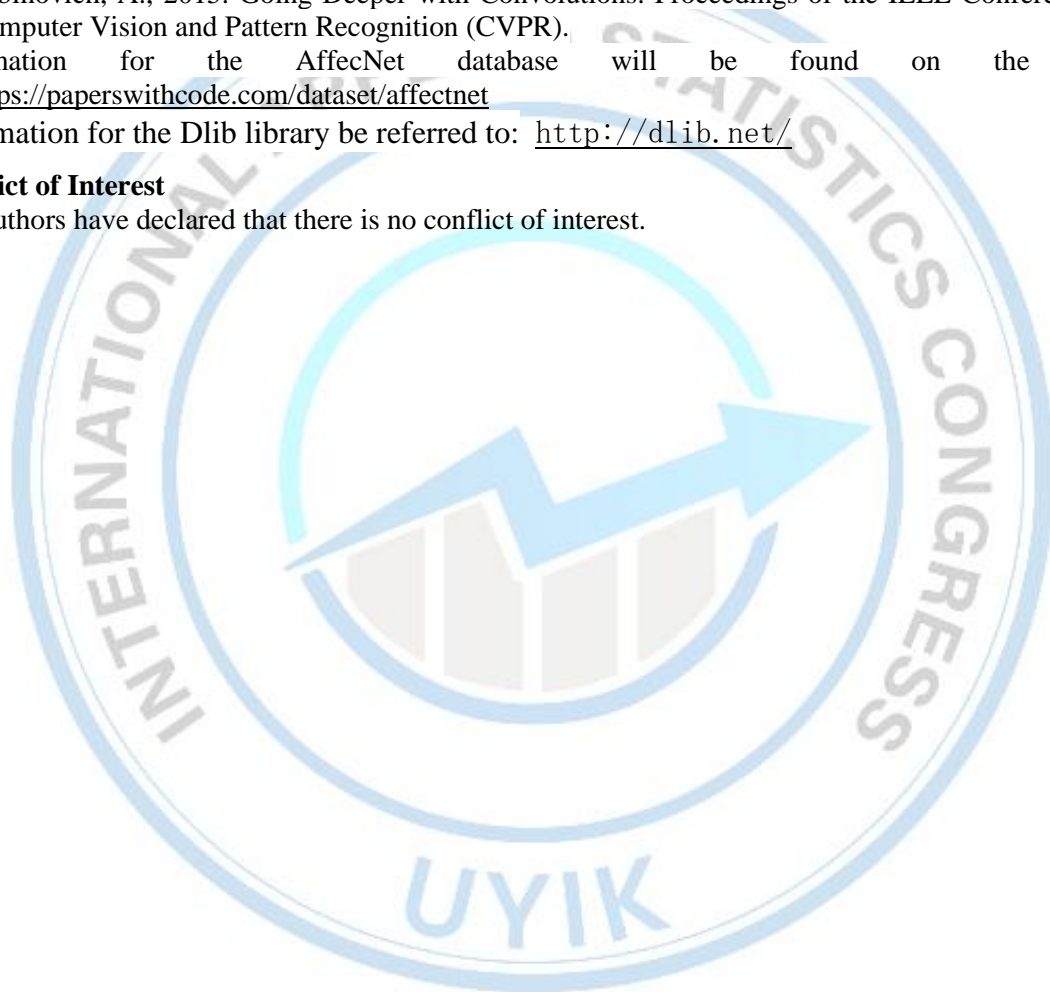
- Ekman, P., 2009. Telling lies: Clues to deceit in the marketplace, politics, and marriage. W.W. Norton & Company.
- Porter, S., & Ten Brinke, L., 2008. Reading between the lies: Identifying concealed and falsified emotions in universal facial expressions. *Psychological Science*, 19(5), 508-514.
- Ekman, P., & Friesen, W. V., 1969. The repertoire of nonverbal behavior: Categories, origins, usage, and coding. *Semiotica*, 1(1), 49-98.
- Zhou, L., Zhao, G., & Pietikäinen, M., 2018. A review of recent advances in visual speech decoding. *Image and Vision Computing*, 78, 53-72.
- Smith, J. B., & Batchelder, W. H., 2010. Beta-MPT: Multinomial processing tree models for addressing individual differences. *Journal of Mathematical Psychology*, 54(2), 167-183.
- Gelman, A., Carlin, J. B., Stern, H. S., Dunson, D. B., Vehtari, A., & Rubin, D. B., 2013. Bayesian data analysis. Chapman and Hall/CRC.
- King, D. E., 2009. Dlib-ml: A machine learning toolkit. *Journal of Machine Learning Research*, 10, 1755-1758.
- van der Maaten, L., & Hinton, G., 2008. Visualizing data using t-SNE. *Journal of Machine Learning Research*, 9(Nov), 2579-2605.
- Ekman, P., & Friesen, W. V., 1978. Facial Action Coding System: A Technique for the Measurement of Facial Movement. Palo Alto: Consulting Psychologists Press.
- Bakiasi, V., & Muça, M., 2023. Comparative Study of K-NN, Naive Bayes and SVM for Face



- Expression Classification Techniques. *Balkan Journal of Interdisciplinary Research*, Vol. 9 No.3, pp.23-32.
- LeCun, Y., Bottou, L., Bengio, Y., & Haffner, P., 1998. Gradient-based learning applied to document recognition. *Proceedings of the IEEE*, 86(11), 2278-2324.
- Cortes, C., & Vapnik, V., 1995. Support-vector networks. *Machine Learning*, 20(3), 273-297.
- Simonyan, K., & Zisserman, A., 2014. Very Deep Convolutional Networks for Large-Scale Image Recognition. *arXiv preprint arXiv:1409.1556*.
- He, K., Zhang, X., Ren, S., & Sun, J., 2016. Deep Residual Learning for Image Recognition. *Proceedings of the IEEE Conference on Computer Vision and Pattern Recognition (CVPR)*.
- Sermanet, P., Eigen, D., Zhang, X., Mathieu, M., Fergus, R., & LeCun, Y., 2013. OverFeat: Integrated Recognition, Localization and Detection using Convolutional Networks. *arXiv preprint arXiv:1312.6229*.
- Szegedy, C., Liu, W., Jia, Y., Sermanet, P., Reed, S., Anguelov, D., Erhan, D., Vanhoucke, V., & Rabinovich, A., 2015. Going Deeper with Convolutions. *Proceedings of the IEEE Conference on Computer Vision and Pattern Recognition (CVPR)*.
- Information for the AffecNet database will be found on the link: <https://paperswithcode.com/dataset/affectnet>
- Information for the Dlib library be referred to: <http://dlib.net/>

**Conflict of Interest**

The authors have declared that there is no conflict of interest.



## Konut Fiyatları Endeksi Yöntemleri ve Uygulama Çalışması

**Cem Bas<sup>1</sup>**

<sup>1</sup>Türkiye İstatistik Kurumu, 06100, Ankara, Türkiye

\*Sorumlu yazar e-mail: cembas@metu.edu.tr

### Özet

*Konut Fiyat Endeksi, ekonomiye yön veren göstergelerden bir tanesidir ve konut piyasasını yansıtan öncül göstergelerin ilk adımudur. Konut fiyatları çok heterojen bir yapıya sahiptir ve tüketiciler farklı kalite ve yapıdaki konutları içeren bir havuzdan tüm konut bileşenlerini içeren bir ürünü satın almaktadır. Konut piyasasında farklı türdeki konutların fiyatlarının tahmin edilmesinde, metrekare, oda sayısı, konum gibi özelliklerin konut fiyatları üzerindeki etkilerinin belirlenmesinde hedonik regresyon yöntemi kullanılmaktadır.*

*Hedonik fiyat endeksi, regresyon analizi kullanılarak bir malın ya da konutun fiyatına etki eden karakter özelliklerinin değerlerinin ayrıştırılmasında kullanılan bir yöntemdir. Heterojen özellik taşıyan malların sahip oldukları özelliklere göre fiyatlandırılarak fiyat ve değişkenler arasında ilişkinin kurulması, hedonik fiyat endeksinin ana mantığını oluşturmaktadır.*

*Satışa konu olan konutların satış değerleri belirlenirken, konutun fiziksel, yapısal, konumsal özellikleri, çevresiyle uyum içinde olup olmaması, konutla ilgili arz talep dengesi, arzu edilen bir konut olması, yatırım aracı olarak görülebilmesi, ihtiyaca göre sosyal imkânlarla sahip olması gibi önemli özellikler dikkate alınmaktadır. Bu çerçevede örnekleme yöntemleri ile belirlenmiş emlakçılara ve konut satışını gerçekleştiren hane halklarına uygulanan soru kâğıdında konutların bu tür özelliklerini ön plana çıkaran sorular sorulmuştur.*

*Konut fiyat endeksi, kişi başına düşen milli gelir, gayri safi milli hâsıla ve enflasyon gibi ekonomik açıdan çok önemli göstergelerle birleştirilerek birçok yeni analize ve çalışmaya kaynak olacaktır. Konut fiyat endeksinin üretilmesi için örneklem ve kullanılacak yöntem büyük önem taşımaktadır. Çalışmada örneklem yöntemlerinin üzerinde durulmuş ve endeksin üretilmesinde en çok kullanılan hedonik regresyon yöntemi ayrıntılarıyla açıklanmıştır.*

**Anahtar Kelimeler:** Hedonik Fiyat Endeksi, Konut Fiyatlarının Belirleyicileri, Regresyon Analizi

### Abstract

*The House Price Index is one of the leading indicators of the economy and the first step of the leading indicators reflecting the housing market. Housing prices are very heterogeneous and consumers buy a product that includes all housing components from a pool of housing of different quality and construction. Hedonic regression method is used to estimate the prices of different types of houses in the housing market and to determine the effects of characteristics such as square meters, number of rooms and location on house prices.*

*The hedonic price index is a method used to decompose the values of the characteristics that affect the price of a good or a house using regression analysis. Establishing a relationship between price and variables by pricing heterogeneous goods according to their characteristics constitutes the main logic of the hedonic price index.*

*While determining the sales values of the houses subject to sale, important features such as the physical, structural and positional characteristics of the house, whether it is in harmony with its surroundings, the supply and demand balance related to the house, being a desirable house, being seen as an investment instrument, and having social facilities according to the needs are taken into consideration.*

*In this framework, questions that highlighted such features of the houses are derived from to real estate agents and households selling houses, which were identified through sampling methods with questionnaires.*

*The house price index will be the source of many new analyses and studies by combining it with economically important indicators such as national income per capita, gross national product and inflation. In order to produce a house price index, the sample and the methodology to be used are of great importance. The study emphasizes sampling methods and explains the hedonic regression method in details, which is the most commonly used method in the production of the index.*

**Keywords:** Hedonic Price Index, Determinants of House Prices, Regression Analysis

## GİRİŞ

Barınma insanların en önemli gereksinimleri arasında yer almaktadır. Konut Fiyat Endeksi (KFE), ülke içerisinde bulunan tüm konutların edinim değerlerinin zaman içerisindeki değişimini gösteren ekonomik bir göstergedir. KFE ülke ekonomisinin durumu hakkında hükümetlerin maliye politikası, merkez bankalarının para politikası ve finansal piyasalar için yararlı olan bir barometre sağlamaktadır. Özellikle Merkez Bankaları konut fiyatlarındaki yükseliş ve düşüşlerin para politikaları üzerindeki istikrarsızlaştırıcı etkisinden kaçınmak için bu konuya çok önem vermektedir.

KFE kapsamında gözlenen değişimler hanehalklarının tüketim yapısında önemli etkilere sahiptir. KFE'nin ölçülmesinde sadece fiyat verisinin gözlenmesi yeterli olmamakta, fiyat verisini etkileyen tüm faktörlerin gözlenmesi büyük önem taşımaktadır. Bu faktörler sadece oda sayısı, yaş gibi konutun yapısı ile ilgili olmayıp, bölge yapısı, çevre yapısı ve demografik etkenleri de içermelidir. Konutların aşırı heterojen yapısı, fiyat değişiklikleri için kalite farklılıklarını elimine eden yeni yöntemlerin geliştirilmesini gerektirmiştir.

Cecchetti (2007), konut fiyatları ile ilgili "enflasyon ölçümüne ilişkin en büyük soru konutun nasıl ele alınacağıdır." ifadesini kullanmıştır. Konu ile alakalı olarak Avrupa Birliği İstatistik Ofisi (EuroStat) Gayrimenkul Fiyat Endeksleri'nin (GFE) nasıl hesaplandığına dair ilişkin bir el kitabı yayımlanmıştır.

KFE gerçek piyasa verilerine veya uzman anketlerine veya ikisinin birleşimine dayanabilir (Vries et al. 2009). Bu endeksin kurulabilmesi için, uygun bir örnekleme yapısı ile benzer konut satışları arasında seçim yapılmasına ya da idari kayıtlardan elde edilen verilerin analiz edilerek kullanılmasına ihtiyaç duyulmaktadır.

## MATERYAL ve YÖNTEMLER

### Materyal

Endekslerin kurulumunda fiyat ve ağırlık referans döneminin seçimi çok büyük önem taşımaktadır. Referans dönemlerinin seçiminde olması gereken özellikler aşağıda belirtilmiştir:

- Referans dönemindeki ekonomik faaliyetlerin herhangi bir krizden etkilenmemesi ve normal koşullara sahip olması gerekmektedir,
- Endeks hesapları yapılacak dönem ile referans dönemi arasındaki zaman diliminin oldukça az olması gerekmektedir,
- Endekste kullanılacak tüm değişkenlerin referans dönemi için de sağlanabilir olması gerekmektedir.

Ağırlık referans dönemi genel olarak bir yılı kapsayan dönemdir. Konut, aşağıda belirtilen üç özelliği ile diğer mallardan ayrılmaktadır:

1. Karmaşıklık: Konut aynı özelliklere sahip olsa bile konumuna, kullanılan içsel malzemeye ve kişisel görüşlere göre farklı değerlere sahip olabilmektedir.
2. Sabitlik: Konut bir taşınmaz olduğu için, konut seçiminde okul, hastane, ulaşım, alışveriş yeri



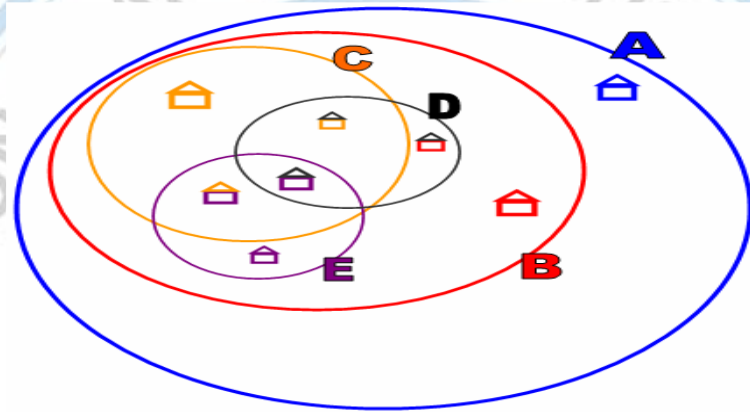
gibi lokasyonlara olan uzaklıkları gibi özellikler büyük önem taşımaktadır.

3. Dayanıklılık: Konutta kullanılan malzeme konutun dayanıklılığını etkilemektedir ve bu özellik konut fiyatını etkileyen unsurdur.

Bunların yanı sıra bir konut endeksinde olması gereken özellikler de aşağıda belirtilmiştir:

- KFE saf fiyat değişimlerini ölçmeli, kalite değişikliklerinden meydana gelen fiyat değişimlerini yansıtmamalıdır,
- Konut fiyat endeksinin temsil etme özelliğine sahip olmalı, belirlenen konumdaki tüm konutları kapsayacak biçimde hesaplanmalıdır,
- Konut fiyat endeksinde hesaplanan değişim oranları nedenleri ile birlikte açıklanabilir olmalıdır,
- KFE dirençli olmalı, en güncel yöntem ve analizlere açık olmalıdır.

Satılan bir konutun tekrar satışa sunulması kısa dönemde mümkün olmadığından ve dönemler itibarıyla her konutun farklı bileşenlere sahip olmasından dolayı fiyatların kalite değişimlerinden arındırılmış bir biçimde endeks hesaplamalarına yansıtılması gerekmektedir.



Şekil 1. Konut Endeksi Hesaplamalarında Veri Kaynakları

Şekil 1’de A tüm konut stoğunu, B satışa konu olan tüm konutları, C ilgili dönemde satışı gerçekleşen konutları, D bankalara kredi başvurusunda bulunmuş ve değerlendirme raporları bulunan konutları, E emlakçıların elinde bulunan konutları göstermektedir. (Baş, 2011) Konut endeksleri genel yapıda C ya da D kümesi kullanılarak hesaplanmaktadır.

Çalışmada ilgili dönemde satışı gerçekleşen (C) kümesi kullanılmıştır. Örneklem yönteminin sağlıklı yapılabilmesi için genel olarak tabakalama yöntemi kullanılmaktadır. Tabakalama yöntemine göre atılması gereken ilk adım konut fiyatı üzerinde etkili olan bileşenlerin tanımlanmasıdır. Bu bileşenler GFE el kitabında aşağıdaki biçimde özetlenmiştir:

- Konutun sahip olduğu metrekare,
- Konutun kapsadığı arsanın payı ve paydası (arsa payı)
- Konutun bulunduğu yerleşim yeri tanımı (kent, kır vb.)
- Konutun yaşı,
- Konutun yapı durumu (apartman, villa, müstakil, yapışik vb.)
- Konutun yapısında kullanılan malzeme (betonarme vb.)
- Diğer önemli özellikler (kapalı garaj, asansör sayısı, banyo sayısı vb.)

KFE diğer endekslerde olduğu gibi bir fiyat endeksidir ve özellikleri belirlenerek sabitlenmiş bir sepetin zaman içerisindeki değişimini ölçer. İlgili sepette konutlar yer almaktadır ve temel dönem 100 değerine sahip olmak üzere diğer dönemlerin endeksleri hesaplanmaktadır. Konut fiyatları endeksi hesaplamalarında 4 farklı yaklaşım kullanılmaktadır.

- Ortanca ya da ortalama fiyat endeksleri,

- Tekrarlanan satış endeksleri,
- Ekspertiz temelli endeskler,
- Hedonik fiyat endeskleri.

Bu endeks yöntemlerinden hedonik fiyat endeksleri kalite değişimlerini endeks hesaplamalarına yansıtmayan en etkili yöntemdir. Bu yöntemde fiyata etki eden tüm faktörler ele alınmakta ve istatistiksel analizler sonucunda bir regresyon denklemi kurulmaktadır. Bu faktörler hem yapısal hem de çevresel tüm bileşenleri kapsamaktadır (Court 1939).

## YÖNTEM

Başlangıç noktası olarak  $p_i^t$  fiyatının,  $t$  döneminde  $i$ 'ninci konut için  $z_{ik}^t$  miktarları ve  $K$  tane özellik ile ölçülen bir fonksiyon olduğu varsayalım.  $T + 1$  zaman dönemi ile, temel dönem  $0$ 'dan dönem  $T$  arasındaki süre için aşağıdaki formül yazılabilir.

$$p_i^t = f(z_{i1}^t, \dots, z_{iK}^t, \varepsilon_i^t), (t=0, \dots, T) \quad (1)$$

Bu eşitlikde  $\varepsilon_i^t$ , rasgele hata terimini (beyaz gürültü) ifade etmektedir. Konut özelliklerinin marjinal dağılımlarının tahmin edilmesi için standart regresyon yöntemlerine başvurulmaktadır ve (1) numaralı parametrik model elde edilmektedir. Hedonik fonksiyonlar için en bilinen modeller;

doğrusal model 
$$p_i^t = \alpha^t + \sum_{k=1}^K \beta_k^t z_{ik}^t + \varepsilon_i^t \quad (2)$$

ve logaritmik doğrusal modeldir. 
$$\ln(p_i^t) = \alpha^t + \sum_{k=1}^K \beta_k^t z_{ik}^t + \varepsilon_i^t \quad (3)$$

Logaritmik doğrusal model genel olarak hedonik fonksiyonlarda kabul edilmektedir ve yapılan dönüşüm ile hata varyansının sabit olmama durumu (heterokedasticity) azaltılmaktadır (Diewert 2009).

$\beta_k^t$  parametrelerinin her dönem için değişmesi bir yöntem olarak kabul edilebilmektedir, fakat zincirleme bir endeks için bu parametrenin sabit kaldığı varsayımı yapılırsa (3) eşitliği aşağıdaki forma dönüşmektedir (Pakes 2003):

$$\ln(p_i^t) = \alpha^t + \sum_{k=1}^K \beta_k z_{ik}^t + \varepsilon_i^t \quad (4)$$

(4) numaralı eşitlik geçmiş stok verilerin kullanılması ile toplam verilerden elde edilmektedir. Bu modellerde kukla değişkenlerin kullanılması ile elde edilen nihai denklem;

$$\ln(p_i^t) = \alpha + \sum_{t=1}^T \delta^t D_i^t \sum_{k=1}^K \beta_k z_{ik}^t + \varepsilon_i^t \quad (5)$$

olarak elde edilmektedir.  $D_i^t$  zaman kukla değişkenini göstermektedir ve eğer gözlem  $t$  döneminden geliyorsa 1, gelmiyorsa 0 değerini almaktadır. Temel yıl dönemlerinde kukla değişken kullanılmamaktadır.

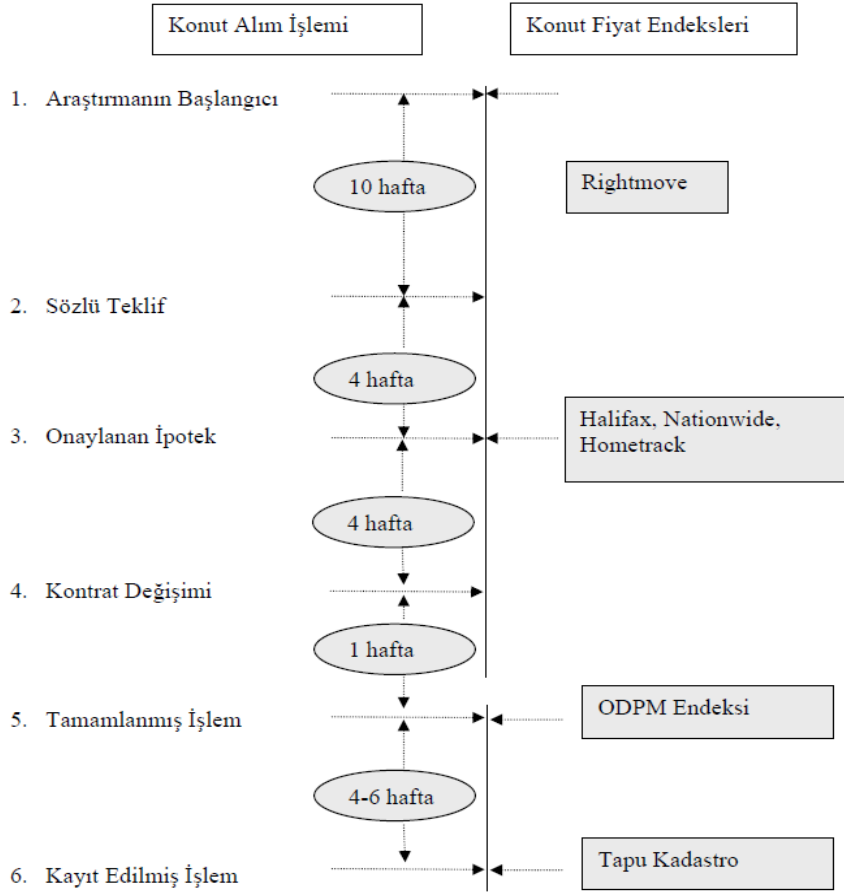
Hangi açıklayıcı değişkenlerin modelde kapsanması gerektiği tüm regresyon denklemlerinde en önemli noktalardan bir tanesidir. Modelin yanlış kurulması ve kapsamın hatalı yapılması önemli sapmalara yol açabilmektedir. Bununla beraber, çoklu bağlantı (multicollinearity) probleminde titizlikle ele alınması büyük önem taşımaktadır.

Yönteme karar verildikten sonra, verilerin derlenmesi önemli diğer noktalardan bir tanesidir. Daha önce de belirtildiği gibi veriler idari kaynaklardan alınabileceği gibi örneklem yolu ile elde edilen veri kaynaklarından anket yolu ile de elde edilebilmektedir. Veriler sadece fiyat değerlerinden oluşmamakta, diğer tüm verileri de içermektedir ve alınan bu fiyat verileri satış adetleri ağırlık kaynağı olarak kullanılmaktadır. Bu ağırlık verileri endeks hesaplarına etki edeceği için seçilen veri kaynağı mutlaka ölçülmek istenen konut endeksine uyumlu olması gerekmektedir.

Konut satış işlemleri belirli bir zaman periyodunda gerçekleştiği, kullanılan veri kaynaklarının bu süreçlerin hangi aşamasında yer aldıklarına bakılması gerekmektedir. Olası fiyat verileri ve kaynaklarına göz atmak gerekirse;

- Konutun satış piyasasına girmesi ile kapsanması: Gazeteler, internet isteleri ve emlak ofisleri,
- İpotek başvuruları: Bankalar,
- İpotek onayları: Bankalar,
- Tamamlanmış konut satışları: Tapu ve kadastro müdürlükleri, vergi daireleri.

Şekil 2’de verilen zaman çizelgesi konut fiyat endeksi için zaman dönemlerini ve adımlarını özetlemektedir.



Şekil 2. Konut Fiyatlandırma ve Konut Fiyat Endeksi Zaman Çizelgesi

Çalışmada, konutların özellikleri ile birlikte fiyat verilerinin de içeren bir anket formu hazırlanmış ve çekilen örneklem ile veriler derlenmiştir. Soru kağıdının hazırlanmasında ve değişkenlerin belirlenmesinde konut satışı yapan internet sitelerinden yararlanılmıştır.

*Konutun fiziksel ve yapısal özellikleri* göz önüne alındığında konutun türü, konutun yaşı, konutun dış cephe yalıtımı, konutun çatı bilgisi, konutun bulunduğu apartmandaki kat sayısı, konutun bulunduğu kat, konutun metrekare bilgisi, konutun oda sayısı, konutun ısıtma sistemi, salonun ve odaların zemin yapısı, banyonun zemin yapısı, mutfağın yapılı olma durumu, konutun duvar boyası, pencerelerin doğrama durumu, asansör sayısı, otomobile ayrılan otopark sayısı, konutun cephesi, konutun manzara durumu ve konutun hidrofor-jeneratör durumu bilgileri alınmıştır.

*Konutun konumsal özellikleri* göz önüne alındığında konutun ilçe bilgisi, konutun marketlere olan yakınlık bilgisi, konutun ulaşım olanaklarına olan yakınlık bilgisi, konutun bankalara olan yakınlık durumu, konutun parklara olan yakınlık durumu, konutun bulunduğu mahallenin gelişmişlik bilgileri alınmıştır.

Konutun satın alma tarihi yıl ve ay detayında veri tabanına işlenmiştir. Konutun satın alış fiyatı gerçekleşen satış bilgisi üzerinden derlenmiş, tapu ve kadastroya belirtilen tutar dikkate alınmamıştır.

#### Örnekleme Yöntemi

Tüm evren bilgisine ulaşılmadığı durumlarda, örneklem evrenin içinden seçilmiş ve evreni temsil eden küçük kümedir. Hem zaman hem maliyet açısından örneklem yöntemleri evrenin parametre tahminlerinin yapılabilmesi için kullanılmaktadır. Örneklemin taşıması gereken özellik yansız ve tahmin



V. INTERNATIONAL APPLIED STATISTICS CONGRESS (UYİK - 2024)  
İstanbul / Türkiye, May 21-23, 2024

edici olmasıdır (Kaptan 1983, s.135). Makalede basit tesadifi örnekleme yöntemine başvurularak seçimler gerçekleştirilmiştir. Bu örnekleme yönteminde evrende yer alan her örneğin seçilme şansı eşittir. (Arıkan 2004, s 141).

Çalışmanın evrenini Tapu ve Kadastro Genel Müdürlüğü'nün Ankara ilinde satışa konu olan konutlar oluşturmuştur. Bir konutun satışa konu olması için konutun parasal bir karşılık ile diğer bir şahıs ya da kuruma satılması şartı aranmaktadır. Örneklem seçiminin yapılması için Ankara ilindeki merkeze yakın ilçelerin nüfus ve konut sayıları da ayrıca sırasıyla Adrese Dayalı Nüfus Kayıt Sistemi (ADNKS) ve Ulusal Adres Veri Tabanı (UAVT) kayıtlarından alınmıştır.

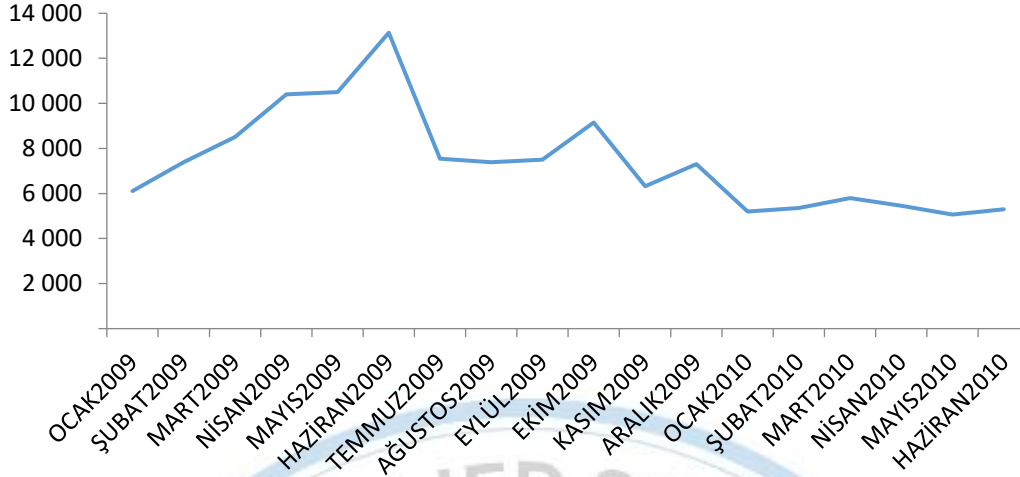
**Tablo 1.** Ankara ili 2009 yılı nüfus (ADNKS) ve konut (UAVT) sayıları

İLCE_AD	ADNKS	UAVT
ALTINDAĞ	367 340	135 907
ÇANKAYA	794 288	331 797
ETİMESGUT	347 267	130 532
GÖLBAŞI	86 749	42 698
KEÇİÖREN	769 646	286 150
MAMAK	532 873	190 868
PURSAKLAR	100 732	36 644
SİNCAN	445 330	148 291
YENİMAHALLE	625 824	257 094

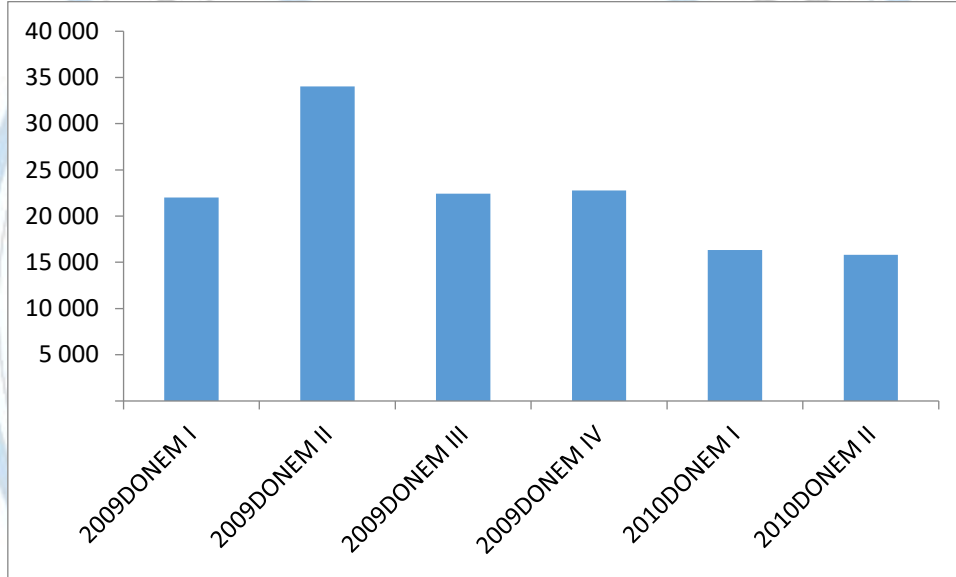
**Tablo 2.** Ankara ili ve İlçelerinde Konut Satış Sayıları

YIL	DONEM	AY	ALTINDAĞ	ÇANKAYA	ETİMESGUT	GÖLBAŞI	KEÇİÖREN	MAMAK	PURSAKLAR	SİNCAN	YENİMAHALE	TOPLAM
2009	DONEM I	OCAK	308	1 111	922	121	1 363	874	180	616	612	6 107
		ŞUBAT	392	1 367	1 102	129	1 698	905	221	762	808	7 384
		MART	381	1 522	1 436	117	1 880	1 040	270	938	928	8 512
		NİSAN	560	2 093	1 536	158	2 074	1 185	269	1 112	1 419	10 406
	DONEM II	MAYIS	526	2 340	1 459	152	2 194	1 194	263	1 081	1 289	10 498
		HAZİRAN	702	3 010	2 180	195	2 296	1 398	331	1 199	1 827	13 138
		TEMMUZ	383	1 337	1 145	131	1 479	1 105	190	838	934	7 542
	DONEM III	AĞUSTOS	495	1 296	1 101	144	1 420	983	223	761	965	7 388
		EYLÜL	401	1 377	1 106	114	1 506	1 036	206	738	1 020	7 504
		EKİM	464	1 585	1 427	146	1 887	1 272	229	1 045	1 096	9 151
		KASIM	364	1 068	809	128	1 373	935	144	633	865	6 319
	2010	DONEM I	ARALIK	432	1 319	1 022	164	1 422	1 107	218	685	928
OCAK			307	934	738	111	1 107	695	126	495	691	5 204
ŞUBAT			263	1 097	766	169	1 035	669	140	487	728	5 354
MART			319	1 138	685	109	1 190	815	183	594	757	5 790
DONEM II		NİSAN	300	1 135	699	70	1 069	680	135	554	807	5 449
		MAYIS	279	932	706	89	978	667	128	566	720	5 065
		HAZİRAN	295	974	760	82	1 008	740	132	422	887	5 300

Tablo 2 incelendiğinde en çok konut satışının Keçiören ilçesinde olduğu göze çarpmaktadır. Çankaya, Etimesgut ve Mamak ilçeleri satışın yoğun olduğu diğer ilçeler olarak gözlenmektedir.



Şekil 3. Ankara İli Aylık Toplam Konut Satış Sayıları



Şekil 4. Ankara İli Dönemlik Toplam Konut Satış Sayıları

Şekil 3 ve Şekil 4 incelendiğinde ise en çok konut satışının olduğu ay 2009 Haziran ve 2009 II. dönem olduğu gözlenmektedir.

Uygun örneklem büyüklüğünün belirlenmesinde tolerans olarak gösterilecek olan hatanın da büyüklüğü büyük önem taşımaktadır. %95'lik güven düzeyinde bu sınır aşağıda belirtilmiştir;

$$\bar{X} \pm 1,96 * (\sigma / \sqrt{n}) \quad (6)$$

(6) numaralı denklemlerde de gözlendiği üzere L örneklem hatası formülü aşağıdaki gibidir;

$$L = 1,96 * (\sigma / \sqrt{n}) \quad (7)$$

(7) numaralı denkleme göre örneklem büyüklüğü aşağıdaki gibi hesaplanmaktadır;

$$n = (1,96^2 * \sigma^2) / L^2 \quad (8)$$

Eğer örnelem büyüklüğü binom bir dağılımın p olasılığı ile tahmin edilmek istenirse (8) numaralı eşitlik aşağıdaki formda yazılabilmektedir;

$$n = (1,96^2 * p * q) / L^2 \quad (9)$$

Tablo 3'de verilen örneklem büyüklükleri, değişik olasılık değerlerine, örneklem hata değerlerine ve güven aralık düzeylerine göre hesaplanmıştır.

Çalışmada örneklem seçimi yapılırken konut satış rakamları ve konut özellikleri homojen

olmadığından dolayı  $p$  olasılık değeri 0,5 olarak alınmıştır.  $L$  örneklem hatası ise konut satışlarının sıklığı göz önüne alınarak 0,05 olarak alınmıştır. Hesaplamalar %95 anlamlılık düzeyinde hesaplanmıştır ve gözlem  $z$  tablosu değeri 1,96 bulunmuştur. Hesaplamalar Ankara ili geneli için yapılacağı için  $deft$  değeri 1 alınmıştır. Bu değişkenlere göre her dönem için 384 örneklem seçiminin alınmasına karar verilmiştir. Örneklem sayısı belirlendikten sonra veri derleme hataları ve cevapsızlık durumlarının etkilerini azaltmak için %15 dolayında bir örneklem ilavesi yapılmıştır. Bu artırım ile her dönem için 442 konut fiyatının ve değişken özelliklerinin derlenmesi kararlaştırılmıştır.

**Tablo 3.** Çeşitli Olasılık, Örnekleme Hatası ve Tablo Değerlerine Göre Örneklem Sayıları

$p$	$q$	$z^*z$	$L$	$L*L$	$Deft$	$N$
0,5	0,5	3,8416	0,025	0,000625	1	1 537
0,5	0,5	3,8416	0,04	0,0016	1	600
0,5	0,5	3,8416	0,05	0,0025	1	384
0,5	0,5	3,8416	0,035	0,001225	1	784
0,5	0,5	3,8416	0,03	0,0009	1	1 067

Ankara ili için bulunan örneklem sayısı 2009 ve 2010 toplam konut satışlarının ilçesel satış oranlarına göre ilçe detayında dağıtıldığında 2009 yılı ve 2010 dönemlerine göre verisi derlenen konut sayıları Tablo 4'de verilmiştir.

**Tablo 4.** Ankara İlçe Detayında Örneklem Sayıları

ilce_kod	İlçe adı	2009	2010 (I)	2010 (II)
1	Altındağ	23	23	23
2	Gölbaşı	7	11	11
3	Pursaklar	12	12	12
4	Sincan	55	42	60
5	Mamak	46	58	42
6	Yenimahalle	57	60	58
7	Etimesgut	67	60	60
8	Keçiören	90	91	91
9	Çankaya	85	85	85
		<b>442</b>	<b>442</b>	<b>442</b>

Örneklem sayıları ilçe detayında hesaplandıktan sonra haneler basit tesadüfi örnekleme yöntemi ile belirlenmiştir. Örnekleme çıkan hanlere ulaşamadığı durumlarda ilgili ilçelerde yapılan konut satışları internet sitelerinden ve emlak ofisi verilerinden elde edilmiştir. Hazırlanan anket kağıdına bağlı kalınarak tüm konut satış verileri dönemlik olarak derlenmiştir.

#### *Tanımlayıcı İstatistikler*

Örnekleme çıkan konutların %90'ı apartman dairesidir. Satılan konutların %50'si gelişmiş, %26'sı orta gelişmiş ve %24'ü az gelişmiş mahallelerde gerçekleşmiştir. Konutların %73'ü 3+1 oda sayısına sahiptir. Konutların %74'ünde bir adet balkon bulunmaktadır. Asansörün bulunduğu satılan konut sayısı %77,7 oranına sahiptir. Satılan konutların %71,8'inde en az bir park yeri bulunmaktadır. Konutların %57'sinin manzaraya sahip olduğu gözlenmiştir.

Tüm tanımlayıcı istatistikler yorumlandığında, birinci el konutlara olan talebin fazlaştığı ve konutların şehir dışına doğru kaydığı gözlenmektedir.

#### *Hedonik Konut Fiyat Endeksi*

Hedonik konut fiyat endeksinin sağlıklı bir biçimde hesaplanabilmesi için, konut fiyatlarının fiyatını etkileyen her bileşenin ve bağımsız değişkenin bilinmesi büyük önem taşımaktadır. Hedonik fiyat



endeksi iki aşamadan oluşmaktadır:

1. Regresyon fonksiyonun tahmin edilmesi,
2. Hedonik regresyon fonksiyonun nasıl kurulması gerektiğine karar verilmesi.

Hedonik konut endeksinde ankette yer alan her değişkenin denkleme bulunmasına ihtiyaç duyulmamaktadır. Değişken varyans, çoklu bağlantı ve korelasyon gibi sorunların denklem kurulmadan önce mutlaka elimine edilmesi gerekmektedir.

Çoklu bağlantı sorununun bulunması için bağımsız değişkenler arasındaki korelasyon değerleri tablosuna bakılmaktadır. Fakat sadece bu kovaryans tablosuna bakmak tek başına yeterli olmayabilmektedir. Çoklu bağlantının en önemli göstergelerinden birisi de Varyans Büyütme Faktörü (VIF) değerleridir. Bir regresyon denkleminde bağımsız değişken sayısı ne kadar çok olursa çoklu bağlantı probleminin de ortaya çıkma ihtimali o derece büyük olabilmektedir. VIF parametre tahminlerinin ve varyanslarının çoklu doğrusal bağlantı nedeni ile gerçek değerinden ne derecede uzaklaştığını göstermektedir. VIF değeri 5'den küçük ise çoklu bağlantının önemli olmadığı sonucuna ulaşılır. Çalışmada kukla değişkenlerin kullanıldığı bağımsız değişkenler için stepwise regresyon tekniği kullanılmıştır.

Tüm bağımsız değişkenler için VIF analizi yapıp değerlere tek tek bakıldığında konutun fiyatına etki eden bağımsız değişkenler Tablo 5'de belirtilmiştir:

**Tablo 5.** Konut Fiyatını Etkileyen Bağımsız Değişkenlerin VIF tablosu

<b>Variable</b>	<b>VIF</b>	<b>1/VIF</b>
Metrekare	1,72	0,581366
Yaş	1,21	0,827682
Pencere	1,30	0,770597
Duvar_Tipi	1,50	0,668670
Banyo	1,41	0,707075
Hidrofor	1,29	0,776421
Asansor	1,12	0,892819
Yesil_Alan	1,18	0,850840
İlce	1,23	0,815146
Manzara	1,26	0,791373
Ulasim	1,05	0,950371
Konum		
2	1,17	0,857519
3	1,14	0,875641
Duvar_Tipi		
1	2,90	0,344835
2	3,26	0,306659

Tablo 5 incelendiğinde konut fiyatını etkileyen ve istatistiksel yöntemlerle seçilen bağımsız değişkenlerin VIF değerinin 5'den küçük olduğu gözlenmektedir. Burada bir örnek vermek gerekirse oda sayısı ve metrekare büyüklüğü arasında bir korelasyon bulunduğu için bağımsız değişkenler içerisinde metrekare büyüklüğü eklenmiş, oda sayısı eklenmemiştir.

#### *Model Fonksiyonu Analizi*

Regresyon denklemleri ile çalışılan hedonik çalışmalarda hangi bağımsız değişkenlerin kapsanacağı ve bu kapsamın tüm veriyi içermesi büyük önem taşımaktadır. Çalışmada istatistiksel tablolar incelendiğinde tam logaritmik modelin en fazla  $R^2$  değerine sahip olduğu gözlenmiştir. Bununla beraber T ve F istatistikleri de diğer önemli bilgileri sağlamaktadır.

Çalışmada hem 2009 hem de 2010 yılı için aynı logaritmik hedonik regresyon modeli kullanılmıştır. 2009 ve 2010 yılları için ekonomik bir değişikliğin söz konusu olmamasının aynı denklemin kullanılması yönünden bir sıkıntı yaratmayacağı öngörülmüştür. Ekonomik bir krizin olması durumunda modellerin en az yılda bir kez gözden geçirilmesi gerekmektedir. Diğer bir deyişle yıllık veri setleri farklı karakteristiklere sahip, farklı denklemlere sahip olabilmektedir. Bu tür yapısal kırılmalar CUSUM, CUSUM-Kare ve CHOW testleri ile gözlemlenebilmektedir. 2009 ve 2010 yılları veri setleri ayrıştırılarak CHOW testi yapılarak kırılmalar araştırılmıştır. Her iki döneme ait varyansların eşitlik testinin ilk adımı yapılması gerekmektedir.

$$H_0 : s_1^2 = s_2^2$$
$$H_A : s_1^2 \neq s_2^2$$

Bu test istatistiği F testi ile yapılmakta ve  $s^2$  bilinmediği için  $Se^2$  değerleri ile sonuçlar karşılaştırılmaktadır.

$$F = \frac{\sigma_{2010}^2}{\sigma_{2009}^2} = \frac{Se_{2010}^2 / (n-k)}{Se_{2009}^2 / (n-k)} = \frac{12,04 / 870}{5,96 / 428} = 0,99 \quad (10)$$

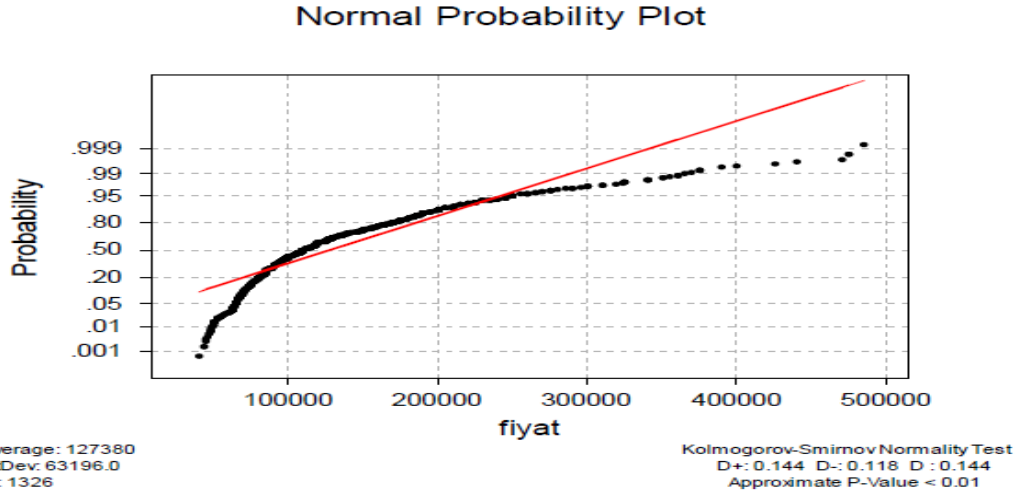
F tablo değeri hesaplanan F değerinden büyük olduğu için  $H_0$  hipotezi reddedilmez, bu durumda varyansların eşit olduğu kabul edilir ve CHOW testi uygulanabilir. Her iki regresyon eşitliği için 2009 veri katsayılarının  $\alpha$  ve 2010 veri katsayılarının  $\beta$  ile ifade edildiği varsayılırsa hipotezler aşağıdaki biçimde yazılır:

$$H_0 : \text{Her } i \text{ için } \alpha_i = \beta_i$$
$$H_A : \text{Herhangi bir } i \text{ için } \alpha_i \neq \beta_i$$
$$F = \frac{[SST - (SS_{2010} + SS_{2009})] / k}{(SS_{2010} + SS_{2009}) / (n_1 + n_2 - 2k)} = \frac{[18,32 - (5,96 + 12,04)] / 14}{(5,96 + 12,04) / 1298} = 1,64 \quad (11)$$

$F_{1298}^{14}$  tablo değeri olan 1,67 hesaplanan F değeri olan 1,64 büyük olduğu için  $H_0$  hipotezi reddedilmez, bunun anlamı tek bir hedonik regresyon denkleminin tüm yıllar için kullanılmasında bir sakınca olmadığıdır.

Hedonik konut endeksi hesaplamalarına geçmeden önce bakılması gereken son nokta değişen varyans probleminin de gözden geçirilmesidir. Değişen varyans sorununun araştırılması için genel olarak garfik yöntemlerine başvurulabilir ve istatistiksel testler kullanılabilir. Çalışmada hem veri setinin çok geniş olması hem de normallik testlerine de bakılması gerektiğinde Breusch-Pagan-Godfrey (BPG) testi değişen varyans sorununun araştırılması için kullanılmıştır. Daha öncede belirtildiği gibi BPG testinin uygulanabilmesi için öncelikle normalliğin test edilmesi gerekir ve Jarque Bera testi için verilerin normal dağılıp dağılmadığı test edilmiştir.

Bununla beraber, regresyon denklemlerinde en küçük kareler yönteminin varsayımlarından bir tanesi de hata terimlerinin normal dağılım varsayımını yerine getirmesidir. Eğer hata terimleri normal dağılıyorsa bu parametrelerin de normal dağıldığını göstermektedir. Hata terimlerinin normal varsayımını test etmek için Kolmogorov Smirnov Normalite Testi çalışmada uygulanmıştır.



**Şekil 5.** Verilerin Kolmogorov Smirnov Normallik Grafiği

Şekil 5’de yer alan P değeri sonuçları incelendiğinde P değeri 0,01 değerine sahip olduğundan dolayı verilerin normal dağıldığı gözlenmektedir. Bu aşamadan sonra BPG testi yapıldığında, hata terimleri varyansının açıklayıcı değişkenlerin farklı fonksiyonu olduğu varsayılır. Yapılan bu test ile birden fazla değişkenin değişen varyansa sahip olup olmadığı incelenmektedir. BPG testinin hipotezi:

$$H_0: \beta_1 = \beta_2 = \dots = \beta_m = 0$$

$H_A$  : En az bir katsayı sıfırdan farklıdır

Tüm veri için  $BPG = \frac{SSE}{2} = \frac{18,32}{2} = 9,16 < 24,74 (\chi_{13}^2(\alpha = 0,05))$  olduğu için değişen varyans sorunu olmadığı gözlenmiştir.

#### *Hedonik Konut Fiyat Endeksi Bileşenleri*

Çalışmada daha önce belirtilen adımlar ışığında, Tapu ve Kadastro konut satışı koşullarını sağlayan evrene göre konutlar örneklem sayıları belirlenmiş ve basit tesadüfi örneklem yöntemine göre ilçeler detayında örneklem seçilmiştir. Hazırlanan soru kağıdına göre veriler hem fiyat bilgisi hem de fiyatı etkileyen bağımsız değişkenleri içerecek biçimde derlenmiştir. Veri girişleri excel programı ortamında yapılmış ve Stata ve Minitab paket programları kullanılarak veriler test edilmiştir.

Çalışmalarda hedonik regresyon denkleminde tüm bağımsız değişkenler konularak başlanmıştır. Çoklu bağlantı, değişen varyans sorunları için belirtilen testler yapılarak sorunlu bulunan bağımsız değişkenler denklem dışına alınmıştır. Son olarak bağımsız değişken olarak alınacak olan değişkenler VIF değerlerine bakılarak seçilmiştir.

Yapılan tüm analizler, testler ve veriler ışığında hedonik regresyon denkleminde kapsanacak olan bağımsız değişkenler ve kurulan tam logaritmik fonksiyon Tablo 6’da belirtilmiştir.



**Tablo 6.** Konut Fiyatını Etkileyen Bağımsız Değişkenlerin Tam Logaritmik Model İçin İstatistiksel Tablosu

```
The regression equation is
ln(fiyat) = 3.52 + 0.688 ln(m2) + 0.068 ln(yas) + 0.168 ln(pencere)
           +0.15 ln(duvar) + 0.400 ln(banyo) + 0.22 ln(asansör)
           +0.126 ln(yesil)+ 0.241 ln(ilce_g) + 0.1 ln(manzara)
           - 0.106 ln(konum) + 0.0430 ln(duvar)
1315 cases used 11 cases contain missing values
```

Predictor	Coef	StDev	T	P
Constant	3.52232	0.07147	49.28	0.000
ln(m2)	0.68814	0.03381	20.36	0.000
ln(yas)	0.06783	0.008613	7.88	0.000
ln(pencere)	0.16794	0.02526	6.65	0.000
ln(duvar)	0.15024	0.01456	5,45	0.000
ln(banyo)	0.40015	0.03713	10.78	0.000
ln(asansör)	0.22475	0.04545	6,87	0.000
ln(yeşil)	0.12578	0.01254	5,47	0.000
ln(ilce_g)	0.24119	0.02588	9.32	0.000
ln(manzara)	0.10457	0,00245	7,86	0.000
ln(konum)	-0.10641	0.01787	-5.95	0.000
ln(duvar)	0.04299	0.01670	-2.57	0.010

S = 0.1307      R-Sq = 70.9%      R-Sq(adj) = 71.2%

Analysis of Variance

Source	DF	SS	MS	F	P
Regression	7	23.1573	3.3082	193.51	0.000
Residual Error	1307	22.3438	0.0171		
Lack of Fit	1090	20.4371	0.0187	2.13	0.000
Pure Error	217	1.9067	0.0088		
Total	1314	45.5011			

## BULGULAR

Tam logaritmik regresyon modeli istatistiksel açıklamalar için diğer modellere göre daha fazla bir yüzdeye sahip olduğu için ve daha esnek bir yapıya sahip olduğu için kullanılmıştır. Başlangıçta fiyatı etkileyen 31 adet bağımsız değişkenle çalışmalara başlanmış ve istatistik yöntemler ile bu bağımsız değişken sayısı Tablo 6'da belirtilen yapıya dönüşmüştür.

Tam logaritmik model incelendiğinde konut satışı fiyatı ile metrekare bilgisi arasında pozitif yönlü bir korelasyon olduğu gözlenmektedir. Ankara ili hava koşulları ve mevsim etkileri göz önüne alındığında pencere yapısının da fiyatlar üzerinde etkili bir değişken olduğu belirlenmiştir. Aynı biçimde duvar yatılımasının olması da fiyatlar üzerinde pozitif bir etki yaratmaktadır.

Bununla beraber konutun asansöre sahip olması, bir manzarasının bulunması ve asansörünün olması da fiyatlar üzerinde pozitif bir etkiye sahiptir.

Özetle, bağımsız değişkenlerin VIF değerlerine bakılıp çoklu bağlantı sorunu olan bağımsız değişkenler elenmiş, CHOW testi ile kırılımlar kontrol edilmiş, BPG testi ile değişken varyans sorunu incelenmiş ve normalite varsayımları diğer istatistiksel testler ile kontrol edilmiştir.

Tüm bu kontrollerden sonra hedonik regresyon denklemi kurularak veriler endeks hesaplamalarına hazır hale getirilmiştir.

## TARTIŞMA VE SONUÇ

KFE tüm ülkeler tarafında konut fiyatlarındaki gelişmelerin takip edilmesi için kullanılan bir araçtır. Konut fiyat verileri birçok ülke tarafından bankalardan alınan konut kredi verilerini içeren idari kayıtlardan oluşmaktadır.

Çalışmada idari kayıtlara ulaşılmaması durumunda izlenebilecek örneklem yöntemleri tanıtılmıştır. Bununla beraber konut fiyat endeksinin hesaplanabilmesi için gerek duyulan verilerin neleri içermesi gerektiği ayrıntıları ile açıklanmıştır.

Konut yapısı gereği çok karmaşık değişkenlere sahip olduğu ve bu değişkenlerin fiyat üzerinde etkileri bulunduğu için kalite düzeltmelerinin endeks hesaplamalarından arındırılması büyük önem taşımaktadır. Hedonik regresyon denklemleri kalite farklılıklarından kaynaklanan fiyat değişimlerinden arındırılması için kullanılan yöntemlerden bir tanesidir ve çalışmada denklemlerin kurulması için izlenmesi gereken adımlar ayrıntıları ile anlatılmıştır.

#### Referanslar

- Arıkan, R. 2004, Araştırma teknikleri ve rapor hazırlama. Ankara: Asil Yayın.
- Baş C, 2011. Konut Fiyatları Endeksi Yöntemleri ve Uygulama Çalışması, Uzmanlık Tezi Türkiye İstatistik Kurumu, Ankara, Türkiye
- Cecchetti S. 2007, "Housing in Inflation Measurement", Access adress <http://www.voxeu.org/index.php?q=node/248>
- Court, A. T. 1939, "Hedonic Price Indexes With Automotive Examples, In The Dynamics; Of Automobile Demand," General Motors, New York Pakes Ariel (2003), "A Reconsideration of Hedonic Price Indexes with an Application PCs", *American Economic Review*, 93(5) (December), pp. 1578-96.
- de Vries P., J. de Haan, E. van der Wal and G. Mari'en 2009, "A House Price Index Based on the SPAR Method," *Journal of Housing Economics*.
- Eurostat 2013, Handbook on Residential Property Price Indices (RPPI), B. Balk (ed.), [http://epp.eurostat.ec.europa.eu/portal/page/portal/hicp/methodology/owner\\_occupied\\_housing\\_hpi/rppi\\_handbook](http://epp.eurostat.ec.europa.eu/portal/page/portal/hicp/methodology/owner_occupied_housing_hpi/rppi_handbook).
- Kaptan S. 1983, Bilimsel araştırma teknikleri ve istatistik yöntemleri.

**Sistematik Meta Analizi ile Belirlenen Risk Faktörleri Sayesinde Web Tabanlı Arayüz  
Tarafından Yapay zeka tabanlı Tip II Diyabet Hastalarında Total Testosteron Seviyesi Tahmini**

**Mehmet Kıvrak<sup>1</sup>, Uğur Avcı<sup>2</sup>, Hakkı Uzun<sup>3</sup>, Cüneyt Ardıç<sup>4</sup>**

<sup>1</sup>Recep Tayyip Erdoğan Üniversitesi Tıp Fakültesi, Biyoistatistik ve Tıp Bilişimi  
Orcid: 0000-0002-2405-8552

<sup>2</sup>Recep Tayyip Erdoğan Üniversitesi Tıp Fakültesi, Endokrinoloji ve Metabolizma Hastalıkları  
Orcid: 0000-0003-1803-5095

<sup>3</sup>Recep Tayyip Erdoğan Üniversitesi Tıp Fakültesi, Üroloji  
Orcid: 0000-0002-5189-3166

<sup>4</sup>Recep Tayyip Erdoğan Üniversitesi Tıp Fakültesi, Aile Hekimliği  
Orcid: 0000-0001-8018-9314

**Özet**

*Diabetes Mellitus; insülin eksikliği veya insülin etkisindeki defektler nedeniyle organizmanın karbonhidrat, yağ ve proteinlerden yeterince yararlanamadığı, sürekli tıbbi bakım gerektiren, kronik, geniş spektrumlu bir metabolizma bozukluğudur. Kesitsel çalışmalarda tüm tip 2 diyabetli erkeklerin %20-80,4'ünde hipogonadizm vardır ve tip 2 diyabetin düşük testosteron ile ilişkili olduğu rapor edilmiştir. Semptomatik hipogonadizmin klinik özelliklerinden bazıları erektil disfonksiyon, libido kaybı, depresyon, sinirlilik, yorgunluk, anemi, entelektüel aktivitede azalma, uyku bozukluğu, karın yağında artış, vücut kıllarında ve kemik mineral yoğunluğunda azalma ve yağsız vücut kütesidir. Testosteron düzeyi, rutin bir hasta tedavi protokolünde genellikle temel bir inceleme değildir. Ancak, belirli semptomlar veya şikayetler varsa veya bir hastalığın teşhisi veya tedavisi için gerekiyorsa, doktorlar testosteron seviyelerini kontrol edebilirler. Burada doktorun tecrübesi önemli bir kriterdir. Doktorlar, semptomlar, hastanın sağlık geçmişi ve diğer faktörler göz önüne alındığında testosteron testi yapma kararı verirler. Bu çalışmanın amacı, tip 2 diyabet hastalarında testesteron düzeylerini tahmin etmek için meta analizler sonucu elde edilen risk faktörlerini kullanmak ve yapay zeka tabanlı makine öğrenme algoritmaları sayesinde bir testesteron tahmin web arayüzü oluşturmaktır.*

**Anahtar Kelimeler:** Total Testosteron, Tip 2 Diyabet, Meta Analiz, Yapay Zeka

**Abstract**

*Diabetes Mellitus is a chronic, broad-spectrum metabolic disorder characterized by the organism's inability to adequately utilize carbohydrates, fats, and proteins due to either insulin deficiency or defects in insulin action, necessitating constant medical care. Cross-sectional studies have reported that 20-80.4% of all type 2 diabetic males have hypogonadism, and type 2 diabetes has been linked to low testosterone. Some clinical features of symptomatic hypogonadism include erectile dysfunction, loss of libido, depression, irritability, fatigue, anemia, decreased intellectual activity, sleep disturbances, increased abdominal fat, decreased body hair and bone mineral density, and lean body mass. Testosterone levels are generally not a routine part of patient treatment protocols. However, doctors may check testosterone levels if specific symptoms or complaints are present or if necessary for diagnosing or treating a condition. The doctor's experience is a significant criterion in this decision. Doctors decide whether to test testosterone levels based on symptoms, the patient's health history, and other factors. The aim of this study is to create a testosterone prediction web interface using risk factors obtained from meta-analyses to estimate testosterone levels in patients with type 2 diabetes, utilizing artificial intelligence-based machine learning algorithms.*

**Keywords:** Total Testosterone, Type 2 Diabetes, Meta Analysis, Artificial Intelligence



## 1. Giriş

Diabetes Mellitus; insülin eksikliği veya insülin etkisindeki defektler nedeniyle organizmanın karbonhidrat, yağ ve proteinlerden yeterince yararlanamadığı, sürekli tıbbi bakım gerektiren, kronik, geniş spektrumlu bir metabolizma bozukluğudur (American Diabetes Association, Diabetes Care (2022)). Tip 2 diyabet tüm diyabet olgularının %90-95 kadarını oluşturmaktadır. Hastalığın temelinde genetik olarak yatkın kişilerde yaşam tarzı ile tetiklenen ve giderek artan insülin direnci ve zamanla azalan insülin salınımı söz konusudur (Türkiye Diyabet Vakfı, Diyabet Tanı ve Tedavi Rehberi (2023)). Hipogonadizm ise testosteron eksikliğinin klinik ve/veya biyokimyasal bir göstergesi olan sendromdur. Kesitsel çalışmalarda tüm tip 2 diyabetli erkeklerin %20-80,4'ünde hipogonadizm vardır ve tip 2 diyabetin düşük testosteron ile ilişkili olduğu rapor edilmiştir. Semptomatik hipogonadizmin klinik özelliklerinden bazıları erektil disfonksiyon, libido kaybı, depresyon, sinirlilik, yorgunluk, anemi, entelektüel aktivitede azalma, uyku bozukluğu, karın yağında artış, vücut kıllarında ve kemik mineral yoğunluğunda azalma ve yağsız vücut kütesidir. Düşük testosteron düzeylerinin yada hipogonadizmin, tip 2 diyabetin majör patojetik mekanizması olan insülin direnciyle ilişkili olduğu bildirilmektedir. Steroidal bir hormon olan testosteron, %95 oranında testislerde bulunan Leydig hücreleri tarafından salgılanan insan vücudunun en önemli androjenidir. Üretimi için ana kaynak kolesteroldür. Testosteron oluşumu Hipotalamustan salgılanan GnRH hormonunun hipofiz bezinden LH hormonunu salgılatması ve LH hormonunun testiste Leydig hücrelerinden testosteron sentezini uyarması ile gerçekleşmektedir. Bu aksın sabah 05 – 11 arası yoğun çalışması ile sabah saatlerinde yoğun miktarda testosteron sentezi gerçekleşmekte, üretim saat 14.00 seviyelerine kadar varlığını idame ettirmeye çalışmakta, sonrasında testosteron sentezi hızla düşmektedir. Günlük üretimi yaklaşık 6-7 mg kadardır. Testosteron sentezini düşürücü faktörlerin varlığında vücut üretimi kompanse etmeye çalışmaktadır. Steroidal bir hormon olan testosteron, %95 oranında testislerde bulunan Leydig hücreleri tarafından salgılanan insan vücudunun en önemli androjenidir. Üretimi için ana kaynak kolesteroldür. Testosteron oluşumu Hipotalamustan salgılanan GnRH hormonunun hipofiz bezinden LH hormonunu salgılatması ve LH hormonunun testiste Leydig hücrelerinden testosteron sentezini uyarması ile gerçekleşmektedir. Bu aksın sabah 05 – 11 arası yoğun çalışması ile sabah saatlerinde yoğun miktarda testosteron sentezi gerçekleşmekte, üretim saat 14.00 seviyelerine kadar varlığını idame ettirmeye çalışmakta, sonrasında testosteron sentezi hızla düşmektedir. Günlük üretimi yaklaşık 6-7 mg kadardır. Testosteron sentezini düşürücü faktörlerin varlığında vücut üretimi kompanse etmeye çalışmaktadır. Testosteron düzeyi, cinsel sağlık sorunları, infertilite, hipogonadizm gibi durumların değerlendirilmesinde önemli bir rol üstlenmektedir. Düşük testosteron varlığı vücutta cinsel istekte (libido) azalma, iktidarsızlık (erektil disfonksiyon), kıllanmada azalma, boyda kısalma (kifoz), osteoporozla bağlı kemik kırıkları gelişmesi, kas kitlesi ve gücünde azalma, sıcak basması, terleme, jinekomasti, azalmış enerji ve motivasyon, sinirlilik, özgüven kaybı, konsantrasyon ve hafızada azalma, üzülmüş hal, depresif belirtiler, artmış uyku hali, iş performansında azalma, vücut yağlanmasında artış, anemi, glukoz toleransında bozulma, insülin direncinde artış, diyabetin regülasyonunda bozulmalar, tip 2 diyabet riskinde artış, koroner arter hastalığı gelişimine olumsuz etki etmek gibi birçok semptom ve bozukluklara yol açmaktadır. Total testosteron seviyeleri, birçok biyolojik, fizyolojik ve çevresel faktörün etkisi altında olan karmaşık bir hormon düzenlemesinin sonucunda oluşmaktadır. Bu faktörler, erkeklerde ve kadınlarda hormonal dengeyi etkileyebilir ve total testosteron seviyelerini artırabilir veya azaltabilir. Genetik yatkınlık, yaş, yaşam tarzı faktörleri, obezite, hormonal durum, beslenme alışkanlıkları gibi etkenler testosteron seviyelerini etkileyebilir. Tip 2 diyabet, metabolik sendrom, obezite, kardiyovasküler hastalık, kronik obstrüktif akciğer hastalığı, böbrek hastalığı ve kanserli hastalar gibi spesifik popülasyonlarda yüksek oranda hipogonadizm prevalansı vardır.

Poliklinik hastalarında hipogonadizm semptomlarının testosteron düşüklüğü ile ilişkisini saptamada temel zorluklar yaşanmaktadır. Birincisi, bu semptomların tamamı diğer birçok hastalık ve metabolik bozulmalarda görülebileceğinden testosteron düşüklüğüne spesifik değildir. Örneğin testosteron

düşüklüğünde akla ilk gelen semptom alan libido azalması hastanın psikolojik durumu, sosyal şartları ve kullandığı ilaçlar gibi birçok farklı sebepten etkilenmektedir. Bu yüzden testosteron hangi seviyenin altına düştüğünde bu semptomların geliştiği ile ilgili bir cut-off değeri elde edilememektedir. Testosteron düşüklüğünü 200 - 400 ng/dL arasında farklı cut-off değerleri çalışmalarda kullanılmaktadır. Ancak üzerinde fikir birliği sağlanmış bir serum değeri bulunmamaktadır. Serum testosteron seviyelerinin belirlenmesinde ikinci engel testostereone replasman tedavilerinin hangi seviyede yapılabileceğinin bilinmemesinden kaynaklı risklerdir. Bir hastada testosteron seviyesi ölçüldüğünde hangi değer altına düştüğünde replasman yapılması gerektiği testosteron eksikliğinin yol açtığı semptomların ve bozuklukların spesifik olmamasından dolayı bilinemediğinden yapılabilecek bir testosteron replasmanı hastaya fayda sağlamak yerine zarar verebilmektedir. Bunun nedeni hastaya uygulanabilecek bir testosteron replasmanı hormonal aksı bozarak, yani dışarıdan verilen testosteronun hipotalamus ve hipofiz üzerinde negatif feed back etki gösterek ve/veya diurnal ritmin dengesini bozarak testosteronun sentezini baskılayabilir ve hasta birçok organ hipogonadizmin etkilerine maruz kalabilir. Bunun en iyi bilinen örneği infertilitedir. Testosteron seviyelerinin semptomlarla ilişkisinin belirlenmesinde üçüncü bir risk faktörü bireylerde testosteron seviyelerinin her gün değişkenlik gösterebileceği ve bu yüzden spesifik bir değer elde edilmesinin getirdiği zorluktur. DM, geç dönem hipogonadizme en sık yol açtığı bilinen hastalıkların başında gelmektedir. Her ne kadar serum testosteron seviyeleri ile semptomlar arasında bir korelasyon saptanamamış olsa da, hipogonadizm semptomlarının varlığında serum testosteronunun 150-200 ng/dL altında tespit edilmesi testosteron replasmanı yapılabileceği hakkında bir kanaat mevcuttur ve yaygın olarak uygulanabilmektedir. Ancak DM'li hastalarda hipogonadizmin semptomların varlığında daha üst seviyelerde serum testosteron seviyeleri sıklıkla saptanabileceğinden hangi durumlarda DM'li hastalarda serum testosteronunun ölçülmesi gerektiği hakkında bir bilgi mevcut değildir. Ayrıca hipogonadizmin ilk görülen ve en spesifik semptomlarından sayılan libido düşüklüğü DM'li hastalarda sıklıkla bir şikayet olarak dile getirilmemekte; bu yüzden DM geç dönem hipogonadizm semptomlarına ve testosteron düşmesine yol açmasına rağmen rutin poliklinik uygulamasında serum testosteron düzeyi ölçümü gerçekleştirilmemektedir. Testosteron düzeyi, rutin bir hasta tedavi protokolünde genellikle temel bir inceleme değildir. Ancak, belirli semptomlar veya şikayetler varsa veya bir hastalığın teşhisi veya tedavisi için gerekiyorsa, doktorlar testosteron seviyelerini kontrol edebilirler. Burada doktorun tecrübesi önemli bir kriterdir (Zarotsky vd, (2014)). Total testosteron düzeyinin rutin olarak ölçülmesi bazı zorluklar ve sınırlamalar içerebilir. Örneğin, testosteron düzeyi, bir gün içinde bile değişebilir. Bu nedenle, tek bir ölçüm, gerçek testosteron seviyesinin tam bir resmini sunmayabilir. Bu nedenlerle, total testosteron düzeyinin değerlendirilmesi ve yorumlanması karmaşıktır. Doktorlar, semptomlar, hastanın sağlık geçmişi ve diğer faktörler göz önüne alındığında testosteron testi yapma kararı verirler.

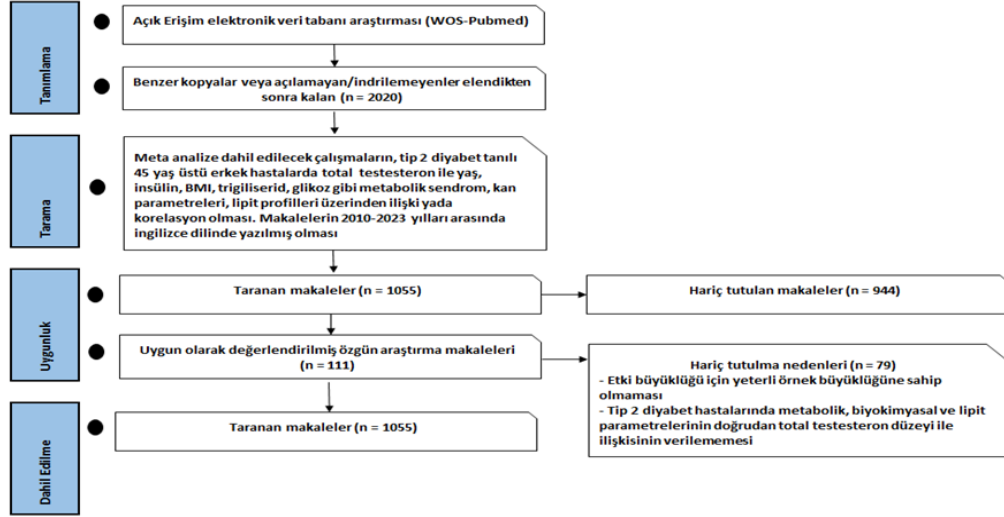
Bu önemli veriler, tip 2 diyabet hastalığı tedavisine total testosteron düzeyi öngörüsünde olası biyobelirteçleri ortaya koyarak yapay zekâ modelleri ile tahminlenmesi oldukça önemli olduğunu göstermektedir. Bu çalışmada, Sistematik Meta Analizi ile Belirlenen Risk Faktörleri Sayesinde bir Web Tabanlı Arayüz Tarafından yapay zeka tabanlı Öğrenmeye Dayalı Tip II Diyabet Hastalarında Total Testosteron Seviyesi Tahmini sayesinde açıklanan boşlukları doldurabilmesi öngörülmektedir.

## 2. Yöntem

### 2.1. Sistematik Derleme

Sistematik derleme, belirli bir konuda mevcut bilgilerin derlenmesi, özetlenmesi ve analiz edilmesi amacıyla yapılan bir araştırma yöntemidir. Bu yöntem, bilimsel literatürdeki mevcut çalışmalarını toplu bir şekilde inceleyerek, belirli bir soruya yanıt aramak veya bir konuyu anlamak için kullanılır. Bu süreçte ilk olarak tip 2 diyabet, testosteron, risk faktör, yaş, insülin, BMI, trigiliserid, glikoz gibi metabolik sendrom, kan parametreleri, lipit profili anahtar kelimeleri belirlenerek arama stratejisi

belirlendi. Daha sonra 2010-2023 yılları arasında PubMed (MEDLINE) ve Web of Science (WOS) veritabanı arama motorları seçilerek, boolean operatörlerini kullanan birleştirilmiş anahtar kelimeler filtrelendi (Tablo 1). Ayrıca belirlenen özgün araştırma makalelerdeki referanslar incelendi ve arama kriterlerini karşılayanlar eklendi. Alınan makalelerin referans listeleri tarandı ve dahil edilme kriterlerini potansiyel olarak karşılayan İngilizce makaleler alınıp analiz edildi. Sistematik derleme çalışması Türkiye, Amerika, Çin, Hindistan, Brezilya, Pakistan, Tayvan ve Güney Kore bölgelerinden elde edilen verilerle ilgilidir. Araştırmaya ait örnek PRIZMA diyagramı şekil 1’de verilmiştir.



Şekil 1. PRİZMA Diyagramı

#### Dahil Edilme Kriterleri

- Tip 2 diyabet tanılı hastalar
- 30 ve üstü erkek hastalar

#### Dışlama Kriterleri

- Tip 1 diyabet tanılı hastalar
- Hipotalamo-hipofizer-gonadal aksta bilinen herhangi bir hastalığı olanlar
- Hipotaloma-hipofizer cerrahi, radyoterapi veya ağır travma öyküsü olanlar
- Gonadal cerrahi, radyoterapi veya ağır travma öyküsü olanlar
- Hipotalamo-hipofizer-gonadal aksı etkileyebilecek bir ilaç (SSRI antidepressanlar, antipsikotikler vb) kullanımı olanlar

Tablo 1. Örnek Sorgu Kriterleri

(((ALL=(testosterone)) AND ALL=(risk factor)) AND ALL=(age)) AND ALL=(insulin)	1055
(((ALL=(testosterone)) AND ALL=(risk factor)) AND ALL=(age)) AND ALL=(globulin)	914
(((ALL=(testosterone)) AND ALL=(risk factor)) AND ALL=(age)) AND ALL=(bmi)	669
(((ALL=(testosterone)) AND ALL=(risk factor)) AND ALL=(age)) AND ALL=(insulin) AND ALL=(globulin)	442
(((ALL=(testosterone)) AND ALL=(risk factor)) AND ALL=(age)) AND ALL=(insulin) AND ALL=(glucose)	467
(((ALL=(testosterone)) AND ALL=(risk factor)) AND ALL=(age)) AND ALL=(insulin) AND ALL=(bmi)	339
(((ALL=(testosterone)) AND ALL=(risk factor)) AND ALL=(age)) AND ALL=(insulin) AND ALL=(Hypertension)	134
(((ALL=(testosterone)) AND ALL=(risk factor)) AND ALL=(age)) AND ALL=(insulin) AND ALL=(triglyceride)	249
(((ALL=(testosterone)) AND ALL=(risk factor)) AND ALL=(age)) AND ALL=(insulin) AND ALL=(smoking)	99
(((ALL=(testosterone)) AND ALL=(risk factor)) AND ALL=(age)) AND ALL=(insulin) AND ALL=(high density lipoprotein)	181



## 2.2. Biyobelirteçlerin Belirlenmesi

Tip 2 diyabet etiyolojisinde total testesteron ile hastalık arasındaki ilişkili faktörler meta analiz ile incelenecektir. Analiz, sonuç ölçüsü olarak log risk oranı kullanılarak gerçekleştirilecektir. Verilere rastgele etkiler modeli yerleştirilerek, heterojenlik miktarı (yani  $\tau^2$ ), maksimum olabilirlik tahmincisi kullanılarak tahmin edilecek (Hardy, (1996)).  $\tau^2$  tahminine ek olarak, heterojenlik için Q testi (Cochran, (1954)) ve  $I^2$  istatistiği de rapor edilecek. Herhangi bir miktarda heterojenliğin tespit edilmesi durumunda (yani,  $\tau^2 > 0$ , Q testinin sonuçlarından bağımsız olarak), gerçek sonuçlar için bir tahmin aralığı verilecektir. Artıklar (hata terimleri) ve Cook mesafeleri, çalışmaların model bağlamında aykırı ve/veya etkili olup olmadığını incelemek için kullanılacak. Standart normal dağılımın  $100 \times (1 - 0,05/(2 \times k))$  yüzdelik diliminden daha büyük hataya sahip çalışmalar, potansiyel aykırı değerler olarak kabul edilir (yani, meta analizde, dahil edilen k çalışmalar için iki taraflı alfa = 0,05 olan bir Bonferroni düzeltmesi kullanılarak). Cook mesafesi medyandan daha büyük olduğu ve Cook mesafelerinin çeyrekler arası aralığının altı katı olan çalışmaların etkili olduğu kabul edilir. Gözlemlenen sonuçların standart hatasını tahminleyici olarak kullanan sıra korelasyon testi ve regresyon testi, huni grafiği asimetrisini kontrol etmek için değerlendirilecektir. Rastgele etki modeli, meta-analizde kullanılarak bilimsel çalışmalar arasındaki heterojenliği dikkate alan bir istatistiksel model verilecektir. Heterojenlik, farklı çalışmaların sonuçlarının rastgele farklılıklar göstermesi durumunu ifade eder. Rastgele etki modeli, çalışmalar arasındaki bu rastgele değişimi dikkate alır ve sonuçların daha genel bir şekilde yorumlanmasına yardımcı olur. Rastgele etki modelinin kullanılması, çalışmalar arasındaki heterojenliği dikkate alarak daha geniş bir sonuç elde etmeye çalışır. Tüm meta analizler de Jamovi 2.4.6 uygulanacaktır (The jamovi project (2023), R Core Team (2022) ve Viechtbauer (2010)).

## 2.3. PICOT

Klinik soruların ve araştırma konularının belirlenmesinde ve klinik araştırmaların tasarımında sıklıkla kullanılan metodolojik bir çerçevedir. Çalışmada, P (popülasyon): tip 2 diyabet hastaları, I (Müdahale/Maruziyet): tip 2 diyabet hastalarında biyokimyasal, metabolik sendrom ve lipit parametrelerinin total testesteron düzeyine risk etkisi, C (Karşılaştırma/Kontrol): tip 2 diyabet hastalarında normal biyokimyasal parametrelere, metabolik sendrom tanısı almamış veya normal lipit profiline sahip bireyler ile diyabet hastalarında sıkça görülen biyokimyasal değişikliklere sahip bireyler (örneğin, yüksek glukoz, insülin direnci), metabolik sendrom tanısı almış veya belirli metabolik sendrom parametrelerine sahip diyabet hastaları yada diyabet hastalarında sıkça görülen lipit profili değişikliklerine sahip bireyler (örneğin, yüksek trigliserit, düşük HDL kolesterol). O (Sonuç): tip 2 diyabet hastalarında total testesteron düzeyine etki eden faktörler arasındaki ilişki, T (Zaman): 2010-2023 yılları arasındaki çalışmaları ifade eder.

## 2.4. Denekler ve Örneklerin Toplanması

Bir bilimsel araştırmaya başlamadan önce çalışmanın planlama aşamasında klinik ve istatistiksel olarak anlamlı sonuçlar elde edebilmek en az kaç birim (denek, hasta, deney hayvanı vb.) gerektiğinin belirlenmesi (teorik güç analizi) ve tamamlanan bir araştırmanın gerçekleşen gücünü ortaya koymak (deneysel güç analizi) oldukça önemlidir. İlgili projede ilk aşama sonucunda araştırmaya dâhil edilebilecek olgu sayısı dikkate alınarak deneysel (geriye yönelik) güç analizi yapılarak proje ekibince geliştirilen WSSPAS (Web-Based Sample Size & Power Analysis Software) web tabanlı yazılımı ile gerçekleşen güç hesaplanacaktır. Örneklem büyüklüğü arttıkça çalışmanın gücü de artacağından ideal olarak bir çalışmanın minimum gücünün 0.80 olması gerektiği belirtilmektedir. Metodolojik araştırma kapsamında tasarlanan bu proje önerisinde tip 2 diyabet tanılı hastalarda tanısı konulan 30 yaş ve üstü güç analizi sonuçlarına göre en az 450 ve üstü hasta, proje başlangıcından itibaren 10 ay içerisinde Recep Tayyip Erdoğan Üniversitesi Eğitim ve Araştırma Hastanesi Aile Hekimliği, Endokrin ve Üroloji polikliniklerinden ileriye yönelik olarak çalışmaya dâhil edilecektir. İlgili etik kurullardan ve yönetim

birimlerinden gerekli izinleri alınarak veri toplanacak deneklerden bilgilendirilmiş onam alınacaktır. Veri toplama çerçevesi oluşturularak polikliniklerden hangi tür verilerin toplanacağını belirten ayrıntılı bir form oluşturulacaktır. Dahil edilme kriterlerini sağlayan deneklerden çapraz kesitsel olarak aile hekimliği, üroloji ve endokrin polikliniklerinde ileriye yönelik sağlık kayıtları taranarak toplanacaktır. Bu form, glikoz, insülin, hemoglobinA1c, keratinin gibi biyokimyasal parametreler, total kolesterol, HDL, LDL, trigliserit gibi lipit profili bileşenleri ve BMI, bel çevresi, kan basıncı gibi tip 2 diyabet göstergeleri ile yaş, diyabet süresi, diyabet öyküsü, yaşam tarzı bilgileri ve total testosteron ölçümlerini içerecektir.

## 2.5. Yapay Zekâ ve Makine Öğrenimi Algoritmaları

### 2.5.1. eXtreme Gradient Boosting (XGBoost) Modeli

XGBoost, Friedman (2001) tarafından geliştirilen gradyan artırma (gradient boosting; GB) yöntemi temelli bir algoritmadır. GB, bir tahmin modelinde, genellikle karar ağaçları gibi zayıf tahmini modellerin topluluk yapısını oluşturan, regresyon ve sınıflandırma problemleri için bir makine öğrenme tekniği olarak tanımlanmaktadır. GB algoritması hem regresyon hem de sınıflandırma problemleri için kullanılır. XGBoost aşırı öğrenmeyi kontrol etmek için daha düzenli bir model yapılandırması kullanır ve bu anlamda GB'den daha iyi performans sağlar. Regresyon ve sınıflandırma ağaçları için artırma (boosting) algoritmalarının kullanımı etkin sonuçlar elde edilmesini sağlamaktadır. Ayrıca XGBoost, yüksek tahmin etme gücüne sahip olup, diğer algoritmalarından 10 kat daha hızlı olmasıyla genel performansı iyileştiren ve aşırı uyum ya da aşırı öğrenmeyi azaltan bir dizi düzenleme (regularization) içermektedir. XGBoost modeli farklı düzenleme teknikleri kullanarak, ağaçların karmaşıklığını kontrol eder ve daha iyi performans elde etmeyi sağlar (Z.S (2018)). XGBoost algoritmasının hiperparametreleri ağaç sayısı, eta öğrenme oranı, vb. karakteristiklerden oluşmakla beraber uygun optimizasyon teknikleriyle optimize edilecektir.

### 2.5.2. Random Forest Modeli

Özellikle biyoinformatik alanında, karar ağaçları topluluğunu, öğrenme sürecinde doğal olarak özellik seçimini ve etkileşimlerini içeren RF tekniği; yorumlanabilir, verimli ve birçok veri türü için yüksek tahmin doğruluğuna sahip bir algoritmadır. RF, verilerden doğrusal olmayan ilişkileri etkili bir şekilde çıkarabilen ve sınıflandırma/regresyon görevleri için kullanılabilen bir istatistik/makine öğrenimi algoritmasıdır. RF gibi topluluk öğrenme algoritmaları, büyük veri kümeleri için çok uygun olup, bağımsız/girdi değişken sayısı gözlem sayısından fazla olduğunda, klasik regresyon modelleri başarılı tahminler vermezken, RF modeli oldukça iyi sonuçlar vermektedir. Hesaplamalı biyolojide küçük örneklem büyüklüğü, yüksek boyutlu özellik uzayı ve karmaşık veri yapılarını çözümlemedeki benzersiz avantajları nedeniyle RF modelinin giderek yaygın bir şekilde kullanıldığı görülmektedir. RF modelinin hiperparametreleri, ağaç yapısının kurulmasında gerekli olan her bir düğümde kullanılacak örneklerin sayısı, oluşturulacak ağaçların sayısı vb. olup, elverişli optimizasyon algoritmaları yardımıyla ayarlanacaktır.

### 2.5.3. Stokastik gradyan artırma (SGB)

Stokastik gradyan artırma (SGB), ağaç tabanlı regresyon ve sınıflandırma görevleri için kullanılabilen güçlü bir algoritmadır. SGB hem artırma (boosting) hem de torbalama (bagging) yaklaşımlarının avantajlarını birleştiren bir melez tekniktir. SGB yönteminin, diğer artırma tabanlı yöntemlerden farklı olarak aykırı/aşırı değerlere ve dengesiz veri setlerine duyarlılığı daha düşüktür. Ayrıca, SGB'nin tahmine dayalı performans açısından incelenen veri kümesi kusurlu ve küçük olsa bile, karar ağaçları, yapay sinir ağları ve destek vektör makineleri dâhil olmak üzere diğer yöntemlerden üstün olduğu bildirilmektedir. SGB'nin eta öğrenme oranı, satır ve sütun örnekleme oranı, vb. hiperparametreleri,

uygun optimizasyon algoritmaları ile en iyilenecektir.

Optimizasyon ile kullanılacak modellemelerde en iyi sonucu veren model belirlenecektir. ilgili model R programlama dili tabanlı oluşturulmuş paketleri kullanılacaktır.

## 2.6. Veri Önleme

Veri setindeki eksik veya hatalı değerleri kontrol etmek, bu değerlerin doldurulması veya çıkarılması, normalizasyon veya standardizasyon gibi işlemler yapılarak verilerin farklı ölçeklerde olması durumunda, bunların aynı ölçeklere getirilmesi, veri dönüşümleri, aykırı-uç değer kontrolleri, sınıf denge sorunu gibi işlemler yapılacaktır.

## 2.7. Modellerin Oluşturulması, Geçerliliği ve Performans Değerlendirmesi

İlgili modelleme aşamalarını gerçekleştirebilmek için total testesteron düzeyinin tahmininde XGBoost, RF, SGB algoritmalarından uygun olan(lar)ı öncelikle eğitimde kullanılacaktır. Bu algoritmalarının eğitiminde ve geçerliliğinin incelenmesinde öncelikle basit geçerlilik (holdout) ve/veya çapraz geçerlilik (cross-validation) yeniden örnekleme yöntemleri uygulanacaktır. Basit geçerlilik yönteminde eğitim-test oranları için çeşitli seçenekler (%70-30, %80-20, %90-10 vb.) denenerek en başarılı performans ölçütlerini verebilecek ayırım tercih edilecektir. Benzer şekilde, çapraz geçerlilik tekniğinin kaç kat (2, 3, 4, vb.) uygulanacağı belirlenmesinde en iyi performans ölçütlerini üretebilecek sayı (kat) seçilecektir. Basit ve çapraz geçerlilik yöntemlerinde uygun oranın/sayının saptanmasında rasgele (random), ızgara (grid) vb. arama optimizasyon teknikleri kullanılacaktır. Hiperparametre optimizasyonu modellerin tahmin performansını etkileyebilecek önemli faktörlerden birisidir. Her model tahmin performansını etkileyecek belirli hiperparametrelere sahiptir. Veri setinden daha doğru sonuçları elde edebilmek, modelin performans çıktısının gücünü arttırabilmek için modelin sahip olduğu hiperparametrelerin çok iyi şekilde ayarlanması gerekmektedir. Model hiperparametreleri genel olarak veriden tahmin edilen veya öğrenilen özelliklerdir. Modelleme aşamasında uygulanacak algoritmaların tahmin performanslarını arttırmak ve aşırı/yetersiz uyum gibi problemleri çözebilmek için ızgara (grid), rasgele (random), diferansiyel evrim (differential evolution), vb. algoritmalarından uygun olan(lar)ı kullanılacaktır. Regresyonda model değerlendirme için üç temel metrik; R<sup>2</sup>/düzeltilmiş R<sup>2</sup>(Açıklayıcılık katsayısı), ortalama kare hata (Mean Squared Error; MSE/kök ortalama kare hata (Root Mean Square Error; RMSE), Ortalama Mutlak Hata (Mean Absolute Error; MAE)/ortalama mutlak yüzde hata (Mean absolute percentage error; MAPE) değerleridir. Total testesteron tahmininde uygulanabilecek modellerin başarımının değerlendirilmesinde öncelikle R<sup>2</sup>/düzeltilmiş R<sup>2</sup>, MSE/RMSE, MAE ve MAPE metrikleri kullanılacaktır.

## 2.8. Biyoistatistiksel Analiz

Nicel veriler ortalama ve standart sapma ya da ortanca (çeyrek sapma), nitel veriler ise sayı ve yüzde ile verilecektir. Nicel verilerin normal dağılıma uygunluğu kolmogorov-smirnov testi ile değerlendirilecektir. Parametrik test varsayımları sağlanırsa, ilgili verilerin önce-sonra karşılaştırmalarında bağımlı örneklerde t testi ve parametrik test varsayımları karşılanmazsa Wilcoxon eşleştirilmiş iki örnek testi kullanılacaktır. İki'den çok tekrarlı verilerin karşılaştırılmasında parametrik test varsayımları sağlanırsa tekrarlı ölçümlerde varyans analizi, sağlanmazsa Friedman testi kullanılacaktır. Anlamlı tekrarlı ölçümlerde yönlü varyans analizi ve Friedman testi sonrası ikili karşılaştırmalar için sırasıyla Bonferroni ve Dunn testleri uygulanacaktır. Korelasyonlar, nicel veriler normal dağılım gösteriyorsa Pearson ve normal dağılım göstermiyorsa Spearman rho vb. korelasyon katsayılarından elverişli olanları ile hesaplanacaktır. P<0.05 değeri istatistiksel olarak önemli kabul edilecektir. Eğer çalışmadaki nicel veriler klinik olarak gruplandırılarak nitel verilere dönüştürülürse, verilerin analizinde Pearson kare testi, Yates Düzeltilmiş kare testi ve Fisher Kesin kare testi uygun olan yerlerde kesin (Exact) yaklaşıma dayalı olarak kullanılacaktır. Bütün



analizlerde/modellemelerde, R yazılımı (Team (2022)), proje ekibi tarafından geliştirilen istatistiksel analiz yazılımı (Yaşar vd.) ve IBM SPSS Statistics version 26.0 for Windows paket program kullanılacaktır.

## 2.9. Yazılım Geliştirme

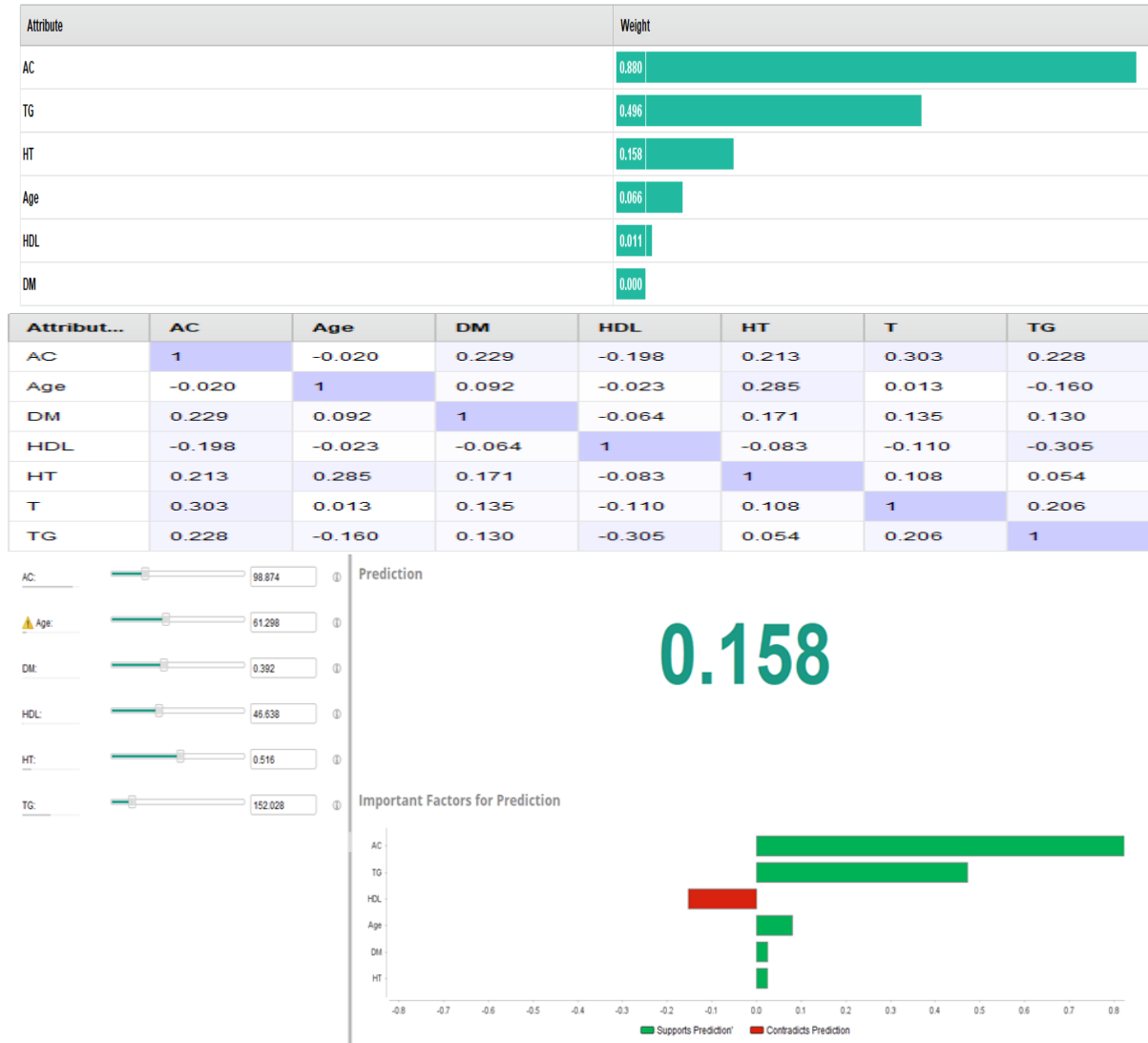
Bu çalışma kapsamında, söz konusu yazılımın, R programlama dilinde Shiny kütüphanesi kullanılarak geliştirilmesi planlanmaktadır. Shiny kütüphanesi, web tabanlı yazılımlar geliştirmek için oluşturulmuş bir kütüphanedir. Fakat web-tabanlı yazılımların büyük verilerin analizinde uygun olmama ihtimali bulunmaktadır. Önerilen proje kapsamında geliştirilecek yazılım, büyük verilerin analizi ve modellemesini yapması hedeflendiği için masaüstü sürümü oluşturulacaktır. Ara yüzü Shiny Kütüphanesi ile geliştirilecek olan yazılımın, masaüstü sürümlerinin oluşturulmasında RInno, electricShine, vb. kütüphaneler kullanılacaktır. Geliştirilecek yazılımın iki ayrı kısımdan oluşması planlanmaktadır. İlk kısımda, testesteron düzeyi tahmin edilecek olan veri setinin yazılıma yüklenmesi işlemi gerçekleştirilecektir. .csv veya .txt uzantılı olan veri setinin büyük veri sınıfına girmesinden dolayı yazılıma hızlı bir şekilde yüklenebilmesi için data.table kütüphanesinin fread fonksiyonu kullanılacaktır. Bu fonksiyon, .csv/.txt uzantılı dosyaların R ortamına yüklenmesini sağlayan temel fonksiyon olan read.table fonksiyonundan çok daha hızlıdır ve sütun ayırıcıların otomatik algılanması vb. gibi belirli avantajlar sunar. İkinci kısımda ise, yazılıma yüklenen veri setinin, daha önce bahsedilen yapay zekâ/makine öğrenmesi modellerinden uygun olanı kullanılarak total testesteron düzeyi tahmini gerçekleştirilecektir. Tahmin işlevi görecek olan ilgili yapay zekâ/makine öğrenmesi modeli, proje kapsamında olgulardan toplanacak olan veri setleri ve testesteron değerleri kullanılarak eğitilecektir. Model eğitimi öncesi ilgili veri seti gerekli veri ön işleme aşamalarından geçirilecektir. Eğitilen bu modelin daha sonra geliştirilen yazılıma eklenmesi (deployment) gerçekleştirilecektir. Yeniden eğitilebilir olarak tasarlanacak bu yapay zekâ/makine öğrenmesi modeli, her yeni olgunun tahmin işlemi gerçekleştirildikten sonra daha önceki eğitim veri setine eklenerek modelin yeniden eğitilmesi ve bu sayede yazılımın geçerlik ve güvenilirliğinin artırılması planlanmaktadır.

## 3. Bulgular

Yazılımın çıktı olarak vereceği simülasyon verileri ile örnek tasarlanmış bir tahmin görseli şekil 2’de verilmiştir.

```
Model Metrics Type: Regression
Description: Metrics reported on full training frame
model id: rm-h2o-model-1
frame id: rm-h2o-frame-model-1
MSE: 0.13189147
RMSE: 0.36316966
R^2: 0.13922134
mean residual deviance: 0.13189147
mean absolute error: 0.26230994
root mean squared log error: 0.25586194
Status of Neuron Layers (predicting T, regression, gaussian distribution, Quadratic loss, 2,951 weights/biases, 39.6 KB, 20,380 training samples, mini-batch size 1):
Layer Units Type Dropout L1 L2 Mean Rate Rate RMS Momentum Mean Weight Weight RMS Mean Bias Bias RMS
1 6 Input 0.00 0.000000 0.000000 0.002451 0.001396 0.000000 0.008348 0.170424 0.423869 0.057255
2 50 Rectifier 0 0.000010 0.000000 0.022122 0.052419 0.000000 -0.018325 0.139839 0.956259 0.050283
3 50 Rectifier 0 0.000010 0.000000 0.000448 0.000366 0.000000 0.016236 0.170744 -0.005001 0.000000
4 1 Linear 0.000010 0.000000 0.000448 0.000366 0.000000 0.016236 0.170744 -0.005001 0.000000
Scoring History:
Timestamp Duration Training Speed Epochs Iterations Samples Training RMSE Training Deviance Training MAE Training r2
2023-08-02 11:38:42 0.000 sec 0.000000 0.000000 0 0.000000 NaN NaN NaN NaN
2023-08-02 11:38:42 0.455 sec 10898 obs/sec 1.000000 1 2038.000000 0.38394 0.14733 0.23817 0.03946
2023-08-02 11:38:42 0.535 sec 15921 obs/sec 2.000000 2 4076.000000 0.37656 0.14180 0.24483 0.07455
2023-08-02 11:38:42 0.608 sec 19287 obs/sec 3.000000 3 6114.000000 0.37044 0.13723 0.29812 0.10440
2023-08-02 11:38:42 0.675 sec 21680 obs/sec 4.000000 4 8152.000000 0.36563 0.13368 0.26094 0.12752
2023-08-02 11:38:42 0.738 sec 23642 obs/sec 5.000000 5 10190.000000 0.36654 0.13435 0.26597 0.12317
2023-08-02 11:38:42 0.799 sec 25264 obs/sec 6.000000 6 12228.000000 0.36671 0.13448 0.25459 0.12235
2023-08-02 11:38:42 0.857 sec 26615 obs/sec 7.000000 7 14266.000000 0.36364 0.13223 0.26097 0.13698
2023-08-02 11:38:42 0.917 sec 27680 obs/sec 8.000000 8 16304.000000 0.36921 0.13631 0.24238 0.11036
2023-08-02 11:38:42 0.977 sec 28614 obs/sec 9.000000 9 18342.000000 0.36317 0.13189 0.26231 0.13922
2023-08-02 11:38:42 1.040 sec 29323 obs/sec 10.000000 10 20380.000000 0.36517 0.13335 0.26212 0.12973
2023-08-02 11:38:42 1.050 sec 29197 obs/sec 10.000000 10 20380.000000 0.36317 0.13189 0.26231 0.13922
H2O version: 3.30.0.1-vm9.8.1
```

V. INTERNATIONAL APPLIED STATISTICS CONGRESS (UYIK - 2024)  
İstanbul / Türkiye, May 21-23, 2024



Şekil 2. similasyon verileri ile örnek tasarlanmış bir tahmin görseli

#### 4. Sonuç

Çalışmanın ilgili paydaşları arasında akademisyenler, araştırmacılar, öğrenciler, diyabet hastaları, sağlık çalışanları, ilaç firmaları ve kamu kurumları bulunmaktadır. Çalışma sayesinde, tip 2 diyabet hastalığına bağlı olarak toplumda oluşan psikolojik, sosyal ve kültürel sorunların azaltılması mümkün olacaktır. Ayrıca, çalışma kapsamında yapay zekâ sistemleri kullanılarak tahminleme tasarımında yeni bir arayüz geliştirilecektir. Bu arayüz, total testesteron düzeyini tahminlemede kullanılan makine öğrenme yöntemlerinin daha hızlı, doğru ve verimli bir şekilde yapılmasını sağlayacaktır. Tip 2 diyabet tedavisinde kullanılacak total testesteron düzeyi elde edilmesi için ucuz, kolay ve çevre dostu bir yöntem sunulması planlanmaktadır. Bu sistem sayesinde klinik karar ve değerlendirme anlık yapılabilecektir. Bu durum da gereksiz teşhis maliyetini ve atık miktarını azaltabilecektir.

#### Kaynaklar

- American Diabetes Association. Standards of medical care in diabetes. Classification and diagnosis of diabetes. Diabetes Care 2022;45(Suppl. 1): S17-S38.
- Arslan, A. K., Yaşar, Ş., Çolak, C. and Yoloğlu, S. 2018. "WSSPAS: an interactive web application for sample size and power analysis with R using shiny". Türkiye Klinikleri Biyoistatistik Dergisi. 10(3), 224-246.

- Bhasin S, Cunningham GR, Hayes FJ, Matsumoto AM, Snyder PJ, Swerdloff RS et al. Testosterone therapy in men with androgen deficiency syndromes: an Endocrine Society clinical practice guideline. *J Clin Endocrinol Metab.* 2010 Jun;95(6): 2536-59.
- Breiman, L. 2001. "Random forests". *Machine learning.* 45(1), 5-32.
- Brownlee, J. 2019. *Better Deep Learning: Train Faster, Reduce Overfitting, and Make Better Predictions*: Jason Brownlee.
- Brydges, C. R. 2019. "Effect size guidelines, sample size calculations, and statistical power in gerontology". *Innovation in Aging.* 3(4), 1-8.
- Carmona, P., Climent, F. and Momparler, A. 2019. "Predicting failure in the US banking sector: An extreme gradient boosting approach". *International Review of Economics & Finance.* 61, 304-323.
- Chang, W., Cheng, J., Allaire, J., Xie, Y. and McPherson, J. 2017. "Shiny: web application framework for R". *R package version.* 1(5), 2017.
- Clark, C. and Chen, B. 2021. "electricShine: Create distributable Shiny Electron apps".
- Chen, T., He, T., Benesty, M., Khotilovich, V., Tang, Y., Cho, H., Chen, K., Mitchell, R., Cano, I. and Zhou, T. 2020a. "xgboost: Extreme Gradient Boosting. R package version 1.0. 0.2".
- Cochran, W. G. (1954). Some methods for strengthening the common  $\chi^2$  tests. *Biometrics,* 10(4), 417-451.
- d'Alché-Buc, F. and Ralaivola, L. 2002. "Incremental learning algorithms for classification and regression: Local strategies". *AIP Conference Proceedings.* 627(1), 320-329.
- Dhatariya K, Nagi D, Jones T. ABCD position statement on the management of hypogonadal males with type 2 diabetes. *Pract Diabetes.* 2010;27(9): 408-12.
- Efron, B. and Tibshirani, R. J. 1994. *An introduction to the bootstrap*: CRC press.
- Efron, B. *Bootstrap methods: another look at the jackknife.* *Breakthroughs in statistics*: Springer; 1992. p. 569-593.
- Friedman, J. H. 2001. "Greedy function approximation: a gradient boosting machine". *Annals of statistics.* 1189-1232.
- Friedman, J. 2002. "Stochastic gradient boosting". *Computational statistics & data analysis.* 38(4), 367-378.
- Gavrilov, A. D., Jordache, A., Vasdani, M. and Deng, J. 2018. "Preventing Model Overfitting and Underfitting in Convolutional Neural Networks". *International Journal of Software Science Computational Intelligence.* 10(4), 19-28.
- George, D. and Mallery, P. 2019. *IBM SPSS statistics 26 step by step: A simple guide and reference*: Routledge.
- Hardy, C. (1996). Understanding power: bringing about strategic change. *British Journal of Management,* 7, S3-S16.
- Hill, J. 2018. "R Inno: An Installation Framework for Shiny Apps".
- Lawrence, R., Bunn, A., Powell, S. and Zambon, M. 2004. "Classification of remotely sensed imagery using stochastic gradient boosting as a refinement of classification tree analysis". *Remote sensing of environment.* 90(3), 331-336.
- Milhorat, T. H., Chou, M. W., Trinidad, E. M., Kula, R. W., Mandell, M., Wolpert, C. and Speer, M. C. 1999. "Chiari I malformation redefined: clinical and radiographic findings for 364 symptomatic patients". *Neurosurgery.* 44(5), 1005-1017.
- Musa E, El-Bashir JM, Sani-Bello F, Bakari AG. Hypergonadotropic hypogonadism in Nigerian men with type 2 diabetes mellitus. *Clin Diabetol.* 2021;10(1): 129-37.
- Pollock, A., & Berge, E. (2018). How to do a systematic review. *International Journal of Stroke,* 13(2), 138-156.
- R Core Team (2022). *R: A Language and environment for statistical computing.* (Version 4.1) [Computer software]. Retrieved from <https://cran.r-project.org>. (R packages retrieved from CRAN snapshot 2023-04-07).
- Schonlau, M. and Zou, R. Y. 2020. "The random forest algorithm for statistical learning". *The Stata Journal.* 20(1), 3-29.



- Shin, Y. 2019. "Application of Stochastic Gradient Boosting Approach to Early Prediction of Safety Accidents at Construction Site". *Advances in Civil Engineering*. 2019, 1574297.
- Suresh, K. and Chandrashekara, S. 2012. "Sample size estimation and power analysis for clinical research studies". *Journal of human reproductive sciences*. 5(1), 7-13.
- Tanyıldızı, E. and Demirtaş, F. 2019. "Hiper Parametre Optimizasyonu Hyper Parameter Optimization". 2019 1st International Informatics and Software Engineering Conference (UBMYK). 1-5.
- The jamovi project (2023). jamovi. (Version 2.4) [Computer Software]. Retrieved from <https://www.jamovi.org>.
- Türkiye Diyabet Vakfı, Ulusal Diyabet Konsensus Grubu. *Diabetes mellitus tanı sınıflama ve izlem ilkeleri. Diyabet Tanı ve Tedavi Rehberi 2023*.
- Türkiye Endokrinoloji ve Metabolizma Derneği, *Diabetes Mellitus ve Komplikasyonlarının Tanı, Tedavi Ve İzlem Kılavuzu 2022*.
- Viechtbauer, W. (2010). Conducting meta-analyses in R with the metafor package. *Journal of Statistical Software*. link, 36, 1-48.
- Villegas, J. L. V., & Choque, R. A. M. (2020). Defining a good research question using the PICOT and FINGER format. *Gaceta Médica Boliviana*, 43(2), DEFINING-A.
- Yaşar, Ş., Arslan, A., Colak, C. and Yoloğlu, S. "A Developed Interactive Web Application for Statistical Analysis: Statistical Analysis Software". *Middle Black Sea Journal of Health Science*. 6(2), 227-239.
- Wang, J., Li, P., Ran, R., Che, Y. and Zhou, Y. 2018a. "A short-term photovoltaic power prediction model based on the gradient boost decision tree". *Applied Sciences*. 8(5), 1-14.
- World Health Organization. *Use of glycated haemoglobin (HbA1c) in the diagnosis of diabetes mellitus: Abbreviated report of a WHO Consultation. World Health Organization 2011, WHO/NMH/CHP/CPM/11.1*.
- Zarotsky, V., Huang, M. Y., Carman, W., Morgentaler, A., Singhal, P. K., Coffin, D., & Jones, T. H. (2014). Systematic literature review of the risk factors, comorbidities, and consequences of hypogonadism in men. *Andrology*, 2(6), 819-834.
- Z.S, P. 2018. "Evaluating XGBoost For User Classification By Using Behavioral Features Extracted From Smartphone Sensors. "

**Nutritional Status and Affecting Factors in Patients Diagnosed with Stroke**

**Şahizer Eraydın<sup>1\*</sup>, Gül Baş<sup>2</sup>**

<sup>1</sup>Tokat Gaziosmanpaşa University, Faculty of Health Sciences, Department of Nursing, Department of Fundamentals of Nursing, Tokat, Türkiye.

<sup>2</sup>Taşova State Hospital. Taşova. Türkiye.

Corresponding author e-mail: sahizer.eraydin@gop.edu.tr

**Abstract**

**Introduction:** Stroke is a clinical condition that occurs when the blood supply to the brain is blocked due to occlusion of blood vessels or bleeding. Individuals diagnosed with stroke may have weakened or lost many functions depending on the brain region affected by the disease. These patients may experience physical disabilities such as speaking, walking and moving. They may also have problems with nutrition.

**Objective:** The aim of this study was to examine the nutritional levels of patients diagnosed with stroke and the factors affecting them.

**Method:** This study was descriptive-cross-sectional in nature. Ethics committee permission and institutional permission were obtained for the study. Informed consent was obtained from the patients. The study was conducted in the neurology clinic of a university hospital. Patients diagnosed with stroke, between the ages of 20-80, who could be contacted and who volunteered to participate in the study were included in the study. The data of the study were collected by face-to-face survey method through a questionnaire form. The data of the study were evaluated with SPSS 25 program. For normal distribution, kurtosis and skewness values were used. Data were presented as frequency, number, percentage and mean. Chi-square test and t test were used for pairwise comparisons.

**Results:** The mean age of stroke patients was  $65.17 \pm 10.33$  years. 32% of the patients were female and 67.5% of the patients were male. 77.5% of the patients were married. 57.5% of the patients lived in the district. 30% of the patients graduated from primary school. 87.5% of patients were diagnosed with ischemic stroke and 12.5% with bleeding stroke. 47.5% of patients had a right-sided stroke and 37.5% of patients had a left-sided stroke. 67.5% of patients had nutritional problems. 45% of patients experienced weight loss. 65% of the patients had chewing problems and 57.5% had swallowing problems.

**Conclusion:** The main result of the study is that stroke patients have nutritional problems. It was observed that patients could not feed themselves, received support from someone else, and did not receive enough fluids and nutrients. Nurses, other members of the healthcare team and patient relatives should consider that stroke patients may experience nutritional problems and malnutrition. It is recommended that they support patients in terms of nutrition.

**Keywords:** Stroke, nutrition, malnutrition

**INTRODUCTION**

Stroke is a clinical condition that occurs when the blood supply to the brain is blocked or reduced as a result of blockage of blood vessels or bleeding. Individuals diagnosed with stroke may weaken or lose many functions depending on the brain region affected by the disease. They may experience physical or psychological deficits such as speaking, walking, and moving (Bellikci et al, 2016). These individuals also experience different problems related to nutrition. It is stated that symptoms and inadequacies such as anorexia, difficulty in chewing, dysphagia, weakness in arm and facial muscles, decreased gastrointestinal system motility, paralysis and impaired level of consciousness, especially in stroke, are

effective in the emergence of malnutrition (Mollaoglu et al, 2010; Am Heart Assoc., 2003).

It is stated that malnutrition is solely responsible for poor clinical outcome in acute ischemic stroke (Naito et al, 2020; Savcı, 2020). It has been reported that malnourished patients have a higher incidence of pneumonia, infections, gastrointestinal bleeding and pressure ulcers than well-nourished patients (Boyras, 2015). Eighteen studies were evaluated in a systematic review and the prevalence of malnutrition after stroke was found to vary between 6-62% (Folley et al, 2009). Malnutrition may increase the risk of infection by weakening the immune system and thus increase mortality. It has also been observed that patients with malnutrition have longer hospital stays (Arsava et al, 2018). Therefore, it is important to ensure that patients have access to adequate and balanced nutrition and to monitor their nutritional status. The problems these patients experience due to stroke affect their feeding activities. Swallowing problems can lead to aspiration and choking.

Intensive nutritional support given to malnourished stroke patients at admission improves clinical outcomes. Therefore, early assessment of nutritional status at admission is very important in stroke patients (Boyras, 2015; Karaca et al, 2010; Savcı, 2020). In the problems experienced by patients due to stroke, nutritional activities are affected and less nutrition is realized than the body needs. Food and fluid intake decreases. In this study, it was tried to determine the nutritional level of patients with functional and physiologic disability due to stroke and the factors affecting nutrition in patients with stroke.

**Objective:** This study was conducted to determine the nutritional levels and factors affecting nutrition in patients diagnosed with stroke.

#### **Research questions**

1. What is the nutritional status of individuals with stroke?
2. What are the factors affecting nutritional status in individuals with stroke?

#### **MATERIALS AND METHODS**

**Type of Study** = This study is descriptive-cross-sectional.

**Place of the Study** = It was conducted in the neurology clinic of a University Hospital in a province in the Black Sea region.

**Population and Sample of the Study**= The population of the study consisted of all patients diagnosed with stroke who were hospitalized in the clinic on the dates of the study. Patients who were admitted to the neurology clinic with a diagnosis of stroke, were between the ages of 20-80, were open to communication and had no communication problems, and who agreed to participate in the study were included in the study.

**Data Collection**= The data of the study were collected using a questionnaire form and face-to-face interviews.

**Data Collection Tools**= The data of the study were collected with a questionnaire form created by the researchers based on the literature. The questionnaire form consisted of two parts. In the first part, there are questions to define the demographic and disease characteristics of the patients. In the second part, there are questions about nutritional characteristics.

**Data Evaluation**= The data were evaluated in SPSS 25 package program. Data were presented as numbers, percentages and averages. T test and chi-square test were used for comparisons.

**Ethical Aspects of the Study**= Permission numbered 21-KAEK-144 was obtained from the Clinical Research Ethics Committee, permission was obtained from the Hospital Administration and written and verbal consent was obtained from the patients. The principles of the Declaration of Helsinki were followed in the conduct of the study.



## RESULTS

The mean age of stroke patients in our study was  $65.17 \pm 10.33$  years with a minimum age of 47 years and a maximum age of 80 years. 32% of the patients were female and 67.5% were male. 77.5% of the patients were married. 57.5% lived in the district, 10% in the village. 30% were primary school graduates. 87.5% of the patients were diagnosed with ischemic stroke and 12.5% with hemorrhagic stroke. 47.5% of the patients had right-sided stroke and 37.5% had left-sided stroke. In our study, 80% of the patients had at least one or more chronic diseases. 41% had diabetes mellitus (DM), 39% hypertension (HT), 12% cardiovascular disease (Table 1). 17.4% of patients had DM + heart disease. 65.2% had DM + HT. 85.7% had cardiovascular disease and HT.

**Table1.** Demographic Characteristics (n=40)

	Mean	Std. D.	Min	Max
Age	65.17	10.33	47	80
Body mass index (BMI)	25,45	4.70	17.01	35.62
		<b>n</b>	<b>%</b>	
Gender	Female	13	32.5	
	Male	27	67.5	
Marital status	Married	31	77.5	
	Single	9	22.5	
Education	Illiterate	4	10	
	Literate	5	12.5	
	Primary school	12	30	
	Middle school	7	17.5	
	High school	10	25	
	University	2	5	
Place of residence	Village	4	10	
	District	23	57.5	
	Province	13	32.5	
Stroke Diagnosis	Ischemic	35	87.5	
	Bleeding	5	12.5	
Landing site	Right	19	47.5	
	Left	15	37.5	
	Right + left	6	15	
Chronic diseases	Yes	32	80	
	No	8	20	
Chronic diseases(n=32)	Diabetes	23	41	
	Hypertension	22	39	
	Cardiovascular disease.	7	12	
	Kidney disease	3	6	
	Cancer	1	2	
			56	100

Nutritional characteristics of the patients are shown in Table 2. 67.5% of the patients had nutritional problems. 55% of the patients experienced weight loss. 32.5% experienced nausea and vomiting, 65% chewing problems, 57.5% swallowing problems. 60% of the patients kept the food in their mouth. 50% of the patients cannot use their arm fully and 50% cannot feed themselves and 50% have anorexia. 55% of patients take vitamin supplements and 85% of patients drink insufficient fluids. Looking at the nutritional problems experienced by gender, 54% of women and 41% of men experienced weight loss. It was found that 85% of women and 60% of men had nutritional problems (Table 2).

**Table2.** Nutritional Characteristics of Patients

		n	%
Feeding problem	Yes	27	67.5
	No	13	32.5
Weight loss	Yes	22	55
	No	18	45
Nausea	Yes	13	32.5
	No	27	67.5
Vomiting	Yes	13	32.5
	No	27	67.5
Anorexia	Yes	20	50
	No	20	50
Chewing problem	Yes	26	65
	No	14	35
Swallowing problem	Yes	23	57.5
	No	17	42.5
Escape to the throat	Yes	21	52.5
	No	19	47.5
Keeping the bite in the mouth	Yes	24	60
	No	16	40
Ability to feed oneself	Yes	20	50
	No	20	50
Use of arm	Yes	20	50
	No	20	50
Ability to take full meals	Yes	13	32.5
	No	27	67.5
Taking supplements	Yes	29	72.5
	No	11	27.5
Taking protein foods	Yes	28	70
	No	12	30
Taking vitamin supplements	Yes	22	55
	No	18	45
Getting enough fluids	Yes	6	15
	No	34	85

## DISCUSSION AND CONCLUSION

In our study, in which we examined the nutritional level and factors affecting nutrition in stroke patients, it was observed that patients had nutritional problems to a great extent. It was observed that patients experienced digestive problems such as nausea, vomiting and loss of appetite, swallowing and chewing problems due to stroke, choking during swallowing and weight loss. Dysphagia is one of the common problems after acute stroke. Although it varies depending on factors such as the duration of the disease, the location and size of the lesion, and the evaluation method used, it has been reported in the literature that the incidence of dysphagia after acute stroke is approximately 29-81%, 70% can recover by the end of the first week, but dysphagia persists for a long time (>6 months) in 11-19% (Savcı 2020; Boyraz, 2015; Karaca et al, 2010). When Paciaroni et al. (2004) evaluated 406 patients diagnosed with stroke within the first 24 hours, they observed that 34.7% developed dysphagia. Smithard, Smeeton, and Wolfe (2007) conducted a long-term follow-up of 1288 first-time stroke survivors and found that 44% developed dysphagia in the first evaluation (Smithard et al, 2007).

Various studies have found that the incidence of stroke is higher in men than in women. That is, men are generally at higher risk of stroke than women (Ali et al, 2023; Campbell et al, 2019). When you examine the distribution of patients by gender in your study, we conclude that 67.5% were male and this

finding is consistent with the data in the literature.

Ischemic stroke is a condition caused by obstruction of blood flow to the brain (Walter, 2022). This is usually due to embolic or thrombotic causes (Feigin et al, 2022). Ischemic stroke occurs in more than 7.6 million people globally annually, accounting for more than 62% of all strokes. Hemorrhagic stroke occurs as bleeding between intracerebral and subarachnoid (Banda et al, 2022). In our study, ischemic stroke was more common in parallel with the literature. Hemorrhagic stroke has a higher mortality rate than ischemic stroke because it causes sudden loss of consciousness and neurological dysfunction. However, the frequency of stroke can be reduced by controlling some risk factors. With advanced and timely treatment, loss of function can be prevented and a good prognosis can be achieved (Norrving et al, 2019).

In our study, patients who could not use their arms or feed themselves had nutritional problems. After stroke, the upper extremity is usually affected more than the lower extremity. Moreover, it has been reported that the upper extremity is weaker in motor recovery after stroke. However, upper extremity functions have an important place in the fulfillment of daily life activities (Koç, 2012). In individuals with stroke, the inability of the patient to use his/her hand and arm, the inability to use spoon and fork for feeding, and being bedridden are problems related to self-feeding (Mollaoğlu2010; Koç 2012).

Age is a non-modifiable risk factor for ischemic stroke and the incidence of stroke increases with advancing age. It has also been shown in the literature that age has an impact on prognosis and the development of complications. Therefore, it is important for elderly patients to take measures such as regular medical follow-up and lifestyle changes to reduce the risk of stroke (Boehme et al, 2017; Çoban & Ekizoğlu, 2021; Kuriakose & Xiao, 2020). Various studies reveal that a large proportion of patients aged 65 years and older are at risk of malnutrition. In a study conducted in Sweden, 1771 hospitalized patients aged 65 years and older were examined and it was reported that 35.5% of the patients were well-nourished, 55.1% were at risk of malnutrition and 9.4% were malnourished (Adolfsson et al, 2013).

Stroke patients have a high risk of malnutrition. In our study, only 32.5% of the patients took full meals and the majority of them did not consume enough fluids. Studies in the literature show that the prevalence of malnutrition can reach up to 45% in the acute period (Rabadi et al. 2008; Nishioka et al, 2016; Cin et al, 2019; Söderström et al, 2013). In addition, in the study conducted by Çoban (2019), it was found that the rate of malnutrition in stroke patients was 52%. The rate of malnutrition detected during hospital admission in acute stroke patients varies between 3.8% and 32%. It is reported that this rate reaches 7.5% to 35% at the end of the second week in the hospital and the rate of malnutrition development increases approximately twofold within two weeks after stroke (Arsava et al, 2018).

Despite different results in studies, we can say that malnutrition after stroke is an important problem. In patients who have had a stroke, eating habits change due to reasons such as impaired consciousness, swallowing problems, posture disorder, decreased mobilization, communication problems, fatigue and depression, and therefore nutritional needs cannot be adequately met. In patients whose nutritional status deteriorates after stroke, it is observed that mortality rates increase in the first week following the disease, hospitalization periods are prolonged due to complications and prognosis worsens. Therefore, the importance of nutritional monitoring in stroke patients is emphasized and the nutritional status of these patients should be closely monitored (Arsava et al, 2018; Zhang et al, 2015).

**Conclusion:** It was observed that the patients had nutritional problems, could not feed themselves, received support from someone else, and did not receive enough fluids and nutrients. Nurses, other members of the healthcare team and patient relatives should consider that stroke patients may experience nutritional problems and malnutrition. They are recommended to support patients in terms of nutrition.



## References

- Ali ZH, Abd-Elaziz M, Abdrbo A, 2023, Dysphagia and daily oral fluids among cerebrovascular stroke patients: an theory-based nursing intervention protocol, *Frontiers of Nursing*, 10(2), 213-222.
- Am Heart Assoc., 2003. FOOD Trial Collaboration, Poor nutritional status on admission predicts poor outcomes after stroke: observational data from the FOOD trial, *Stroke* 34.1450–1456.
- Arsava EM, Aydođdu İ, Güngör L, Işıkkay CT, Yaka E, 2018. Nutritional approach and treatment in patients with stroke, an expert opinion for Turkey. *Turkish Journal of Neurology*, 24(3), 226-242.
- Banda KJ, Chu H, Kang XL, Liu D, Pien LC, Jen HJ, Hsiao SS, Chou KR, 2022, Prevalence of dysphagia and risk of pneumonia and mortality in acute stroke patients: a meta-analysis, *BMC Geriatr*, 22(1), 420.
- Bellikci Koyu E, Kaner G, Akal Yıldız E, 2016. " "The effect of stroke and nutrition on stroke." *Gümüşhane University Journal of Health Sciences*. 5.4 : 112-118.
- Boehme AK, Esenwa C, Elkind MS, 2017, Stroke risk factors, genetics, and prevention, *Circulation research*, 120(3), 472-495.
- Boyraz S, 2015. Swallowing and nutrition in individuals with stroke. *Türkiye Clinics Journal of Internal Medicine Nursing-Special Topics*, 1(1):1-6.
- Campbell BC, De Silva DA, Macleod MR, Coutts SB, Schwamm LH, Davis SM, Donnan GA, 2019, Ischaemic stroke, *Nature reviews Disease primers*, 5(1), 70.
- Cin A, Boyraz S, Öztürk V, Yaka E, 2019. Malnutrition in elderly stroke patients. *Turkish Journal of Cerebrovascular Diseases*, 25(3), 155-163.
- Çoban EK, 2019. Malnutrition Rate in Stroke Patients on Admission. *Med Bull Sisli Etfal Hosp*. 53(3), 272-275.
- Çoban O, Ekizođlu E, 2021. Definitions, Classification, Epidemiology and Risk Factors in Cerebrovascular Diseases. In A. E. Öge, B. Baykan, & B. Bilgiç (Eds.), *Nöroloji*: 293-297
- Feigin VL, Brainin M, Norrving B, Martins S, Sacco RL, Hacke W, Fisher M, Pandian J, Lindsay P, 2022, World Stroke Organization (WSO): global stroke fact sheet 2022, *International journal of stroke*, 17(1), 18-29.
- Folley NC, Salter KL, Robertson J, Teasell RW, Woodbury MG, 2009. Which reported estimate of the prevalence of malnutrition after stroke is valid? *Stroke* 40. e66–e74.
- Karaca Umay E, Gürçay E, Ünlü E, Eksiođlu E, Çakıcı A, 2010. Functional and Nutritional Effect of Dysphagia in Early Stroke Patients. *Türkiye Clinics*. 30(3):925-31.
- Koç A, 2012. Daily living activities in stroke. *Gülhane Medical Journal*. doi:10.5455/ gulhane.25410.
- Kuriakose D, Xiao Z, 2020, Pathophysiology and Treatment of Stroke: Present Status and Future Perspectives, *International Journal of Molecular Sciences*, 21(20), 7609.
- Mollaođlu M, Kars-Fertelli T, Özkan-Tuncay F, 2010. The relationship between cognitive levels and nutritional status of elderly individuals with stroke. *Journal of Research and Development in Nursing*.30-37.
- Naito H, Hosomi N, Nezu T, Kuzume D, Aoki S, Morimoto Y, Maruyama H, 2020. Prognostic role of the controlling nutritional status score in acute ischemic stroke among stroke subtypes. *Journal of The Neurological Sciences*, 416, 116984. <https://doi.org/10.1016/j.jns.2020.116984>.
- Nishioka S, Okamoto T, Takayama M, Urushihara M, Watanabe M, Kiriya Y, Kageyama N, 2017. Malnutrition risk predicts recovery of full oral intake among older adult stroke patients undergoing enteral nutrition: Secondary analysis of a multicentre survey (the APPLE study). *Clinical nutrition*, 36(4), 1089-1096.
- Norrving B, Barrick J, Davalos A, Dichgans M, Cordonnier C, Guekht A, Kutluk K, Mikulik R, Wardlaw J, Richard E, 2019, European Action Plan for Stroke 2018-2030, *Turkish Journal of Cerebrovascular Diseases*,25(2), 54-85.
- Paciaroni M, Mazzotta G, Corea F, Caso V, Venti M, Milia P, et al., 2004.Dysphagia Following Stroke. *Eur Neurol*. 51(3):162-67.
- Rabadi MH. Coar PL, Lukin M, Lesser M, Blass JP, 2008. Intensive nutritional supplements can improve outcomes in stroke rehabilitation, *Neurology* 71. 1856–1861.
- Savcı C, 2020, Individualized nursing care in acute stroke patients who develop dysphagia. *Anatolian Journal of Nursing and Health Sciences*. 23(3): 423-429. DOI: 10.17049/ataunihem.478025.
- Smithard D, Smeeton NC, Wolfe CDA, 2007. Long-term Outcome After Stroke: Does Dysphagia

- Matter. Age and Ageing 2007;36(1):90-4.
- Söderström L, Adolfsson ET, Rosenblad A, Frid H, Saletti A, Bergkvist L, 2013. Mealtime habits and meal provision are associated with malnutrition among elderly patients admitted to hospital. Clinical Nutrition, 32(2), 281-288.
- Walter K, 2022. What Is Acute Ischemic Stroke? , JAMA, 327(9), 885-885.
- Zhang J, Zhao X, Wang A, Zhou Y, Yang B, Wei N, Wang Y, 2015. Emerging malnutrition during hospitalisation independently predicts poor 3 month outcomes after acute stroke: data from a Chinese cohort. Asia Pacific journal of clinical nutrition, 24(3), 379-386.

**Acknowledgment**

We thank all the patients who participated in our study.

**Conflict of Interest**

"The authors have declared that there is no conflict of interest".

**Author Contributions**

**ŞE:** Study design, study management, data collection, data evaluation, interpretation, writing the article  
**GB:** Study design, data collection.



**An Investigation of Monthly Maximum Temperature Changes as an Indicator of Climate Change Using Functional Data Analysis: The Case of Antalya Province**

İsmail Kaya<sup>1</sup>, İstem Köymen<sup>2\*</sup>

<sup>1</sup>Amasya University, Suluova Vocational School, Property Protection and Security, 05100, Amasya, Türkiye

<sup>2</sup>Dokuz Eylül University, Faculty of Economics and Administrative, Econometrics, 35160, İzmir, Türkiye

\*Corresponding author e-mail: istem.koymen@deu.edu.tr

**Abstract**

*One of the most fundamental indicators of climate change is the increase in monthly maximum temperatures over the years. To this end, monthly maximum temperature data were analyzed for Antalya Province, a region in Turkey where extreme weather events have become particularly evident in recent years. The data were examined for 9 stations over the period 1985-2023. When examined collectively over the entire time period, the temperature curves exhibited a steady increase, while the magnitude of the fluctuations also showed a marked increase over the years. The functional data analysis, utilizing cubic spline functions, allowed for the investigation of the derivatives of the curves for the 9 stations, as these curves were found to be differentiable functions. This enabled the examination of the first and second derivative functions, which provide insights into the speed and acceleration of the temperature curves. Furthermore, the functional clustering analysis identified four main clusters of stations that exhibited similar changes in temperature over the years. By revealing the underlying geographical, climatic, and human factors driving this clustering, this study lays the groundwork for the development of common climate change action plan recommendations for these clusters in future research.*

**Keywords:** Climate Change, Extreme Weather Events, Monthly Maximum Temperature, Functional Data Analysis

**INTRODUCTION**

Long-term time series and spatial density are required to analyze the impacts associated with global climate change. However, many temporal datasets in national and international databases have gaps due to various reasons (Smith et al., 2011). These gaps pose an obstacle to the necessity for at least 30 years of data, which is a requirement in the climate change literature (Dauji, 2023).

In a warming world, the frequency and intensity of climate change-related hazards are expected to increase on a global scale (AghaKouchak et al., 2020). When extreme weather events, which are indicators of climate change in Turkey, are analysed, it is observed that there is an incredible increase in Turkey.

The average of extreme weather events between 2011-2020 exceeded 650, and did not fall below 1000 in the 2021-2023 period. In Antalya province, especially as of 2015, extreme weather events of wind, precipitation and temperature origin have started to be experienced frequently. There are numerous examples of the diversity of these extreme weather events and their occurrence in various locations within different provincial boundaries.

In order to observe climate change, the province of Antalya, which is the province where extreme weather events are most common in our country, and the stations with the number of data that can show the change that occurs in the long term are focused.

In this study; it is aimed to convert the monthly maximum temperature data into continuous functions by means of basis functions and to observe the increase in temperature, to enable the first and second derivative functions to be examined by using cubic splines in the analyses and thus to capture the sudden



ups and downs in the original curves more easily, and finally to determine the stations that move together in the long term with functional clustering analysis. Thus, it will be possible to determine why the districts that show similar behaviour in the long term move together and similar suggestions can be made in disaster risk reduction plans in future studies.

## METHODS

### The Collection of the Data

Monthly maximum temperature data for the period from January 1980 to December 2023 for all stations in 19 districts of Antalya province were requested from the Turkish Ministry of Environment, Urbanization and Climate Change General Directorate of Meteorology. However, due to the significant proportion of missing data at certain stations, the time period for the analysis was adjusted to January 1985 to December 2023 to ensure more meaningful analyses. Additionally, the selected stations for this analysis are from the districts of Alanya, Muratpaşa, Elmalı, Finike, Gazipaşa, Demre, Kaş, Korkuteli, and Manavgat.

### Statistical Analysis

#### *Basis Function Approach*

Flexible methods are needed to construct the  $x(t)$  function, or in other words, the individual station monthly maximum temperature curves. For this purpose, a system consisting of  $K$  basis functions is selected. The  $x(t)$  function to be created can be written as a weighted sum of these basis functions as follows:

$$x(t) = \sum_{i=1}^K c_i \theta_i(t)$$

In this expression,  $\theta_i$  is the  $i$ -th basis function and  $c_i$  is the coefficient corresponding to this base function. Here  $c_i$ ,  $i=1, 2, \dots, K$  coefficients are the coefficients that determine the shape and form of the function  $x(t)$ . In a sense they can be interpreted as parameters. The 'Roughness Penalty' smoothing method aims to estimate the  $c_i$  coefficients. In summary, the approach that aims to estimate the function  $x(t)$  as a weighted sum of  $K$  basis functions is called the 'Basis Function Approach'. In the basis function approach, B-Splayn, Wavelets or Fourier basis are often used.

#### *Roughness Penalty Approach*

After determining the Fourier basis functions represented as  $\theta_i$ , the second step involves estimating the coefficients  $c_i$  to obtain individual functions. For this purpose, the Roughness Penalty Approach is used. In functional data analysis, when fitting data to a curve, the goal is not only to achieve a good fit but also to obtain a curve prediction with minimal fluctuations, which actually conflicts with the primary aim of achieving a good fit. The primary objective of the Roughness Penalty Approach, commonly used for smoothing functions in functional data analysis, is to measure the roughness of the curve and to strike a balance between the fit of the data to the curve and the smoothness of the curve.

In the Roughness Penalty Approach, when obtaining roughness penalty estimates, let  $x(t)$  be a function defined on the interval  $T=[a,b]$  for which the derivative can be taken, and let  $\lambda > 0$  be the smoothing parameter. The penalized sum of squares is expressed as

$$CKT_{\lambda} = \sum_{j=1}^N (y_j - x(t_j))^2 + \lambda \|D^2x\|^2$$

can be expressed as. The roughness penalty term expressed as  $\lambda \|D^2x\|^2$  ensures that the penalized least squares of a particular curve are determined not only by the goodness of fit to the data, measured solely by the residual sum of squares  $\sum_{j=1}^N (y_j - x(t_j))^2$ , but also by its roughness, expressed as  $\lambda \|D^2x\|^2$ , guaranteeing decision-making based on both the goodness of fit to the data and the roughness (Green and Silverman, 1994).

### Functional Cluster Analysis

While clustering algorithms have found wide application for many years, there are relatively few methods available for clustering functional data that emerge in the form of curves. However, the need for clustering analysis of functional data is increasingly recognized today. Traditional clustering does not consider the temporal structure. Functional clustering analysis is available for clustering such data (Tzeng et al., 2018).

In functional clustering analysis, clustering algorithms are used to create subgroups for a set consisting of curves. In clustering, the curves within clusters are similar to each other while being as dissimilar as possible from other clusters (Strandberg, 2014).

Although clustering methods specifically tailored to functional data have been developed, many researchers have preferred to apply traditional clustering methods such as hierarchical and k-means clustering to functional data, as these methods are well-known in their fields and there are known software packages available for their implementation (Ferreira and Hitchcock, 2009). This method has also been preferred in this study.

Functional clustering analysis, although similar to the classical method, considers distances between curves  $x_i(t)$  and  $x_j(t)$  through the  $L_2$  norm (Giraldo et al., 2012; Henderson, 2006; Hitchcock et al., 2007; Ferreira and Hitchcock, 2009).

$$d_{ij} = \sqrt{\int_{[t_1, t_n]} (x_i(t) - x_j(t))^2 dt}$$

### FINDINGS

In order to interpret the results more meaningfully, the map of Antalya province is given in Figure 1.



Figure 1. Antalya Province Map

When Figure 2 is analysed, it is seen that the monthly maximum temperature curves between 1985-2023 show a regular increase. Here, each curve represents a station in Antalya province. It is seen that the monthly maximum temperature is highest in summer months (July-August) and lowest in winter months (December-February). Especially the increasing trend that started in 2007 has led to the breaking of maximum temperature records in many districts.

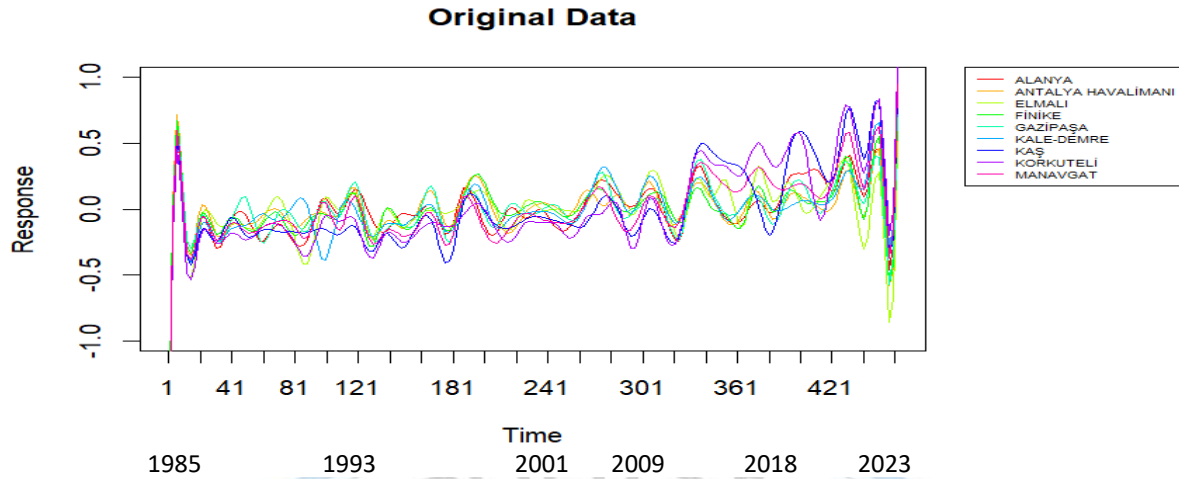


Figure 2. Monthly Maximum Temperature Curves

The points where the first derivative is zero give points that can be maximum or minimum, and the curves are increasing in positive regions and decreasing in negative regions. As seen in Figure 3, it can be clearly observed from the first derivative functions that the magnitude of the increases and decreases in the curves increased after 2009. In summary, when all years are analysed together, it is seen that the temperature shows a regular increase, but it also shows that the magnitude of the ups and downs increases over the years.

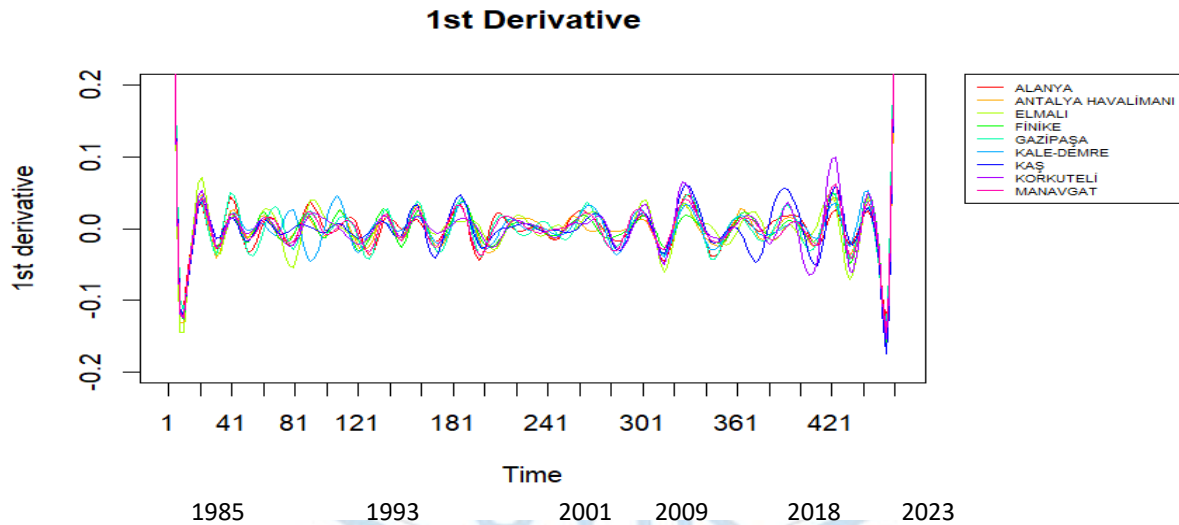
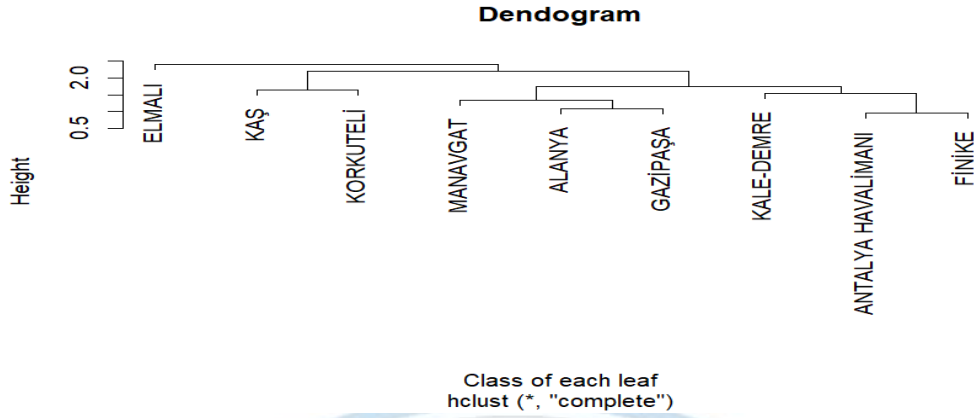


Figure 3. Monthly Maximum Temperature First Derivative Curves

As years passed, it has been observed that both the increase and fluctuations in monthly maximum temperatures have increased, which is evident through the curves and their first derivative curves. Additionally, one of the main aims of the study is to identify station curves that exhibit similar behavior over the period of interest and examine why they move together. To achieve this goal, functional clustering analysis, which takes into account the temporal dimension, has been employed.

In clustering functional data, it is useful to smooth the observations and cluster the smoothed curves rather than the observed data (Hitchcock et al., 2007; Giraldo et al., 2012). In this study, hierarchical and k-means methods, using curves as inputs, were employed. The dendrogram generated by functional clustering analysis is provided in Figure 4, the relevant clustering table in Table 1, and the clustered curves in Figure 5.



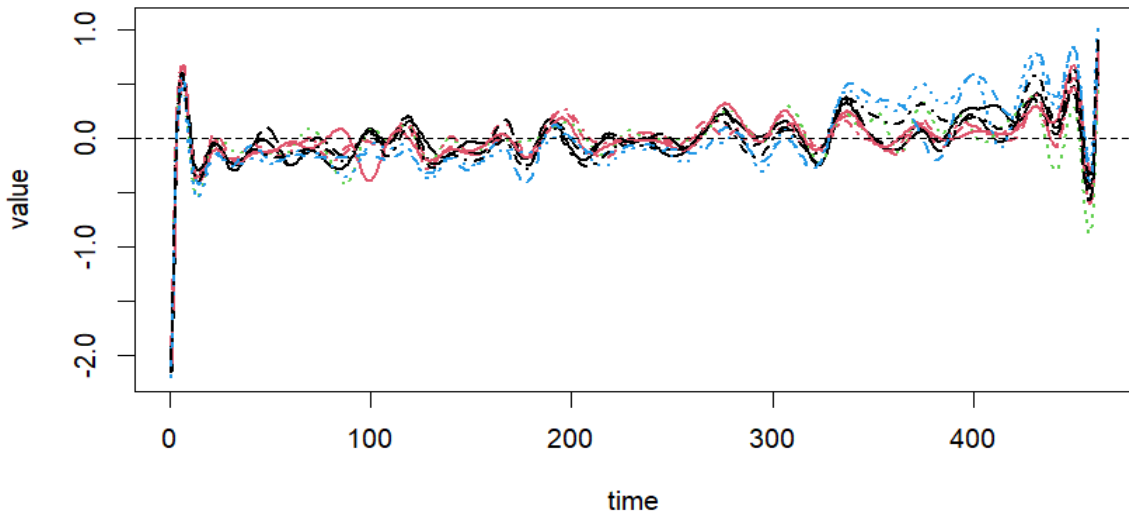


**Figure 4.** Dendrogram Created According to Functional Clustering Analysis

Upon examination of the dendrogram, it is observed that four main clusters have formed. The first cluster consists of Alanya, Manavgat, and Gazipaşa, while the second cluster includes Finike, Muratpaşa, and Demre. The third cluster is composed of Kaş and Korkuteli districts, while Elmalı stands alone in the fourth cluster. The reasons why these stations move together have been investigated in terms of geographical, climatic, and human factors. These clusters are summarized in Table 1 according to the colors in Figure 5.

**Table 1.** Clustering Table According to Functional Clustering Analysis

Stations	Cluster 1	Cluster 2	Cluster 3	Cluster 4
ALANYA	X			
MANAVGAT	X			
GAZİPAŞA	X			
FİNİKE		X		
ANTALYA HAVALİMANI (MURATPAŞA)		X		
KALE-DEMRE		X		
KORKUTELİ			X	
KAŞ			X	
ELMALI				X



**Figure 5.** Curves Clustered by Colour in Functional Clustering Analysis

The first cluster includes Alanya, Manavgat, and Gazipaşa, which are primarily coastal districts adjacent to the Mediterranean Sea. Therefore, they may experience milder weather conditions and higher humidity due to the influence of the Mediterranean Sea and temperature. As a result, similar temperature trends may be observed.

The second cluster includes Finike, Demre, and Muratpaşa districts, which also have coastlines along the Mediterranean Sea. Finike and Muratpaşa districts show similarity in terms of the predominant wind direction, which is also northward.

Although Kaş and Korkuteli districts may appear to have few common characteristics, they have shown similarity in monthly maximum temperature variations over the years. One of these few common characteristics is that while the lower altitudes of both districts experience a Mediterranean climate, the higher altitudes experience a Continental climate. Furthermore, another similarity is that both districts have similar vegetation that affects the retention of sunlight and thermal equilibrium, with both areas having maquis vegetation.

In the fourth cluster, Elmalı stands alone. Its distinctive topography, characterized by mountainous and heavily forested areas, and its proximity to the Taurus Mountains, contribute to its different temperature trend compared to other districts. Additionally, Elmalı's engagement in agriculture results in less urbanization, reducing the formation of urban heat island effect.

In addition, the complex impact of human activities may affect temperature changes in a region in a discernible manner, and the effect may not be the same in every area. In the four clusters resulting from clustering analysis, where districts with similar monthly maximum temperature changes emerge, it should be noted that besides all natural factors, human activities such as urbanization, agriculture, industrialization, forestry, and land use also play a role, and moreover, they can directly contribute to temperature changes. For example, increasing green areas can lead to a decrease in perceived temperature, while deforestation due to industrial activities can increase perceived temperature.

## DISCUSSION AND CONCLUSION

Through spline functions and derivative functions, it has been clearly demonstrated that monthly maximum temperatures have significantly increased over the years, with the rate of increase and decrease also increasing. Comparisons have been made at the station level using derivative functions, and the rates of increase and decrease have been compared. By employing functional clustering analysis, districts that move together during extreme weather events throughout the entire time period have been identified, and the underlying reasons have been determined. In future studies, measures to address temperature-related issues in climate action plans can be developed based on clustering. While studies on examining temperature trends and underlying causes in the context of climate change have been encountered (Özfidaner et al., 2018; Özfidaner et al., 2019; Ünal et al., 2020; Külahci and Aslan, 2023), no study has been found that identifies stations showing co-variation over the years and investigates the underlying reasons. Such studies would greatly facilitate planning for disasters.

## References

- AghaKouchak A, Chiang F, Huning LS, Love CA, Mallakpour I, Mazdidasni O, ... & Sadegh M, 2020. Climate Extremes and Compound Hazards in A Warming World. *Annual Review of Earth and Planetary Sciences*, 48: 519-548.
- Dauji S, 2023. Climate Change Indications in Short-Period Rainfall Records from Coastal India Using Trend Analysis: A Proposed Framework. *Arabian Journal of Geosciences*, 16(3): 189.
- Ferreira L, Hitchcock DB, 2009. A comparison of Hierarchical Methods for Clustering Functional Data. *Communications in Statistics-Simulation and Computation*, 38(9): 1925-1949.
- Giraldo R, Delicado P, Mateu J, 2012. Hierarchical Clustering of Spatially Correlated Functional Data. *Statistica Neerlandica*, 66(4): 403-421.
- Green PJ, Silverman BW, 1994. *Nonparametric Regression and Generalized Linear Models: A*

- Roughness Penalty Approach. Chapman & Hall: London.
- Henderson B, 2006. Exploring between Site Differences in Water Quality Trends: A Functional Data Analysis Approach. *Environmetrics: The Official Journal of the International Environmetrics Society*, 17(1): 65-80.
- Hitchcock DB, Booth JG, Casella G, 2007. The Effect of Pre-Smoothing Functional Data on Cluster Analysis. *Journal of Statistical Computation and Simulation*, 77(12):1043-1055.
- Külahci C, Aslan Z, 2023. Modelling and Future Prediction of Land Surface Temperature by Arıma Method: Antalya Application. *Journal of Anadolu Bil Vocational School*, 18(67): 81-90.
- Özfidaner M, Şapolyo D, Topaloğlu F, 2018. Determination of Trends in Antalya Average Temperature Data with a New Trend Analysis Method. *Journal of the Faculty of Agriculture*: 223-228.
- Özfidaner M, Uçan DŞ, Topaloğlu F, 2019. Determination of Trends in Average Temperature Data: Antalya and Alanya Case. *Mustafa Kemal University Journal of Agricultural Sciences*. 24: 106-111.
- Smith A, Lott N, Vose R, 2011. The Integrated Surface Database: Recent Developments and Partnerships. *Bulletin of the American Meteorological Society*, 92(6): 704-708.
- Strandberg J, 2013. Cluster Analysis for Functional Data, Master Thesis. Umeå University, Sweden. Access address: <https://www.diva-portal.org/smash/get/diva2:691473/FULLTEXT01.pdf> Date of access: 04.06.2024.
- Tzeng S, Hennig C, Li YF, Lin CJ, 2018. Dissimilarity for Functional Data Clustering Based On Smoothing Parameter Commutation, *Statistical Methods in Medical Research*, 27(11): 3492-3504.
- Ünal A, Özaslan BS, Ünal O, 2020. The Effect of Climate Change on *Culex pipiens* Linnaeus, 1758 (Diptera: Culicidae, House Mosquito) in Antalya Province. *Sinop University Journal of Science and Technology*, 5(2): 147-162.

#### **Conflict of Interest**

The authors have no conflicts of interest to declare.

#### **Author Contributions**

The authors contributed equally to the study.



## Investigation of Energy Changes of Investment Instruments Through Phase Planes

Burak Baran<sup>1</sup>, İstem Köymen<sup>1\*</sup>, İpek Deveci Kocakoç<sup>1</sup>

<sup>1</sup>Dokuz Eylül University, Faculty of Economics and Administrative, Econometrics, 35160, İzmir, Türkiye

\*Corresponding author e-mail: istem.koymen@deu.edu.tr

### Abstract

*This study aims to obtain insights into the risk of investment instruments by analyzing their energy changes with the help of phase planes. The research uses second-order phase planes to understand the changing behavior of investment instruments over economic periods. These planes allow for a visual inspection of energy changes and dynamics in the system along the time axis. The two-dimensional phase plane reflects the relationship between potential and kinetic energy along one horizontal and one vertical axis. Potential energy is related to acceleration and kinetic energy to velocity. The harmonic behavior in which the system moves between two states shows a loop around the origin. The motion of this loop must be clockwise around the origin. The larger the radius of the loop, the more energy the system has, which indicates the magnitude of the motions of the variable under study. The dollar, euro, BIST-100 index and various cryptocurrencies were analyzed as investment instruments. As for the period, considering the significant impact of the pandemic process, the years 2020-2023 were taken as a basis. As a result of the study, it is seen from the width of the cycles that the energy changes of cryptocurrencies are much higher, especially during the pandemic. Fluctuations in other investment instruments are much smaller. It can also be said that investment instruments with similar phase planes exhibit similar fluctuations. In this case, especially silver and gold, dollar and euro and cryptocurrencies show similar behaviors. These findings may contribute to making more informed investment decisions by providing information about investors' preferences.*

**Keywords:** Phase Plane, Energy Change, Investment Instruments

### INTRODUCTION

Since ancient times, people have preferred a shopping system in which they use the barter method to buy goods that they cannot produce themselves or that are difficult to obtain or that they need. This system, which started with the barter method and then continued with precious metals such as gold and silver, was replaced first by wire transfers through banks and then by cryptocurrencies, which are digital payment methods (Deniz, 2020). Although cryptocurrencies were first heard of with Satoshi Nakamoto and Bitcoin, the blockchain was first introduced by Wei Dai, a computer engineer, in 1998 in an article in which he explained the concept of “B-money”. Shortly after this article, another blockchain pioneer, Nick Szabo, tried to develop a digital money mechanism called Bit Gold. Although neither of them officially started, it can be said to be the inspiration for Bitcoin (Moreland, 2019).

In this study, it is aimed to compare the behavior of classical investment instruments such as dollar, gold, bist100 and newer investment instruments such as cryptocurrencies and to make a recommendation to investors in terms of risk. For this purpose, functional data analysis and phase planes were utilized.

### METHODS

#### The Collection of the Data

In this study, 10 cryptocurrencies including Btc, Eth, Bnb, Trx, Xrp, Xmr, Matic, Doge, Atom, Ada coin, as well as BIST-100, silver, gold, dollar and Euro exchange rates were analyzed in the time interval 01.01.2020-31.07.2023. The data used in the study were taken from the Investing website where

cryptocurrencies and instant market data are available.

### Statistical Analysis

#### *Functional Data Analysis*

Functional Data Analysis (FDA) is generally designed to investigate changes in data over time. These changes include changes in the mean and variance within and between curves. In FDA, the observations are not values of random variables but random function curves. Change over the years can sometimes be explained more meaningfully in degrees of derivatives. The role of derivatives in the analysis forces researchers to treat data as functions rather than vectors at discrete times (Allen, 2011). In FDA, functions can be constructed in such a way that derivatives of the desired degree can be obtained. For this purpose, the basis function approach is utilized. For this, a system consisting of  $K$  basis functions is chosen. The desired function  $x(t)$  can be written as a weighted sum of these basis functions as follows:

$$x(t) = \sum_{i=1}^K c_i \theta_i(t)$$

In this expression,  $\theta_i$  is the  $i$ -th basis function and  $c_i$  is the coefficient corresponding to this basis function. Here  $c_i, i=1, 2, \dots, K$  coefficients are the coefficients that determine the shape and form of the function  $x(t)$ . In a sense, they can be interpreted as parameters. In the basis function approach, B-Spline, Wavelets or Fourier basis are often used.

#### *Phase Plane*

If the goal of research is to represent data in a way that illuminates different characteristics and emphasizes the dynamical activities in a system, a useful way to achieve this is to use the phase plane, a sub-state of the two-dimensional phase space where the first derivative is analyzed against the second derivative.

A single point in phase space describes the state of a complex system, such as a nuclear reactor, a spacecraft or a human body. This point and its motion show the change in the state of the system. This point is called a phase point, image point or representation point. The second-order phase plane plots, where the first-order derivative is plotted against the second-order derivative considered in this study, are an important way to show the evolution of the underlying process along the time axis. Thus, the slowdown and acceleration of the variables in our study can be visually examined.

The phase plane is a very useful tool for investigating the energy change during a wave cycle. Energy is the effort and work needed to show the change in a system over time. Especially in real-world problems, the second-order phase plane can be a powerful tool for describing the relationships between variables due to the relationship between kinetic energy and potential energy. Potential energy is related to acceleration (second derivative) and kinetic energy to velocity (first derivative) (Allen, 2011). A sequence of energy changes is similar to a circle. At its center is the minimum potential energy. Initially the circles are large. As the frictions activate, the pendulum makes fewer arcs and the total energy decreases. The circle becomes a spiral and moves towards the center. A system that shows large circles in a phase plane drawing is considered to have excess total energy (West, 2007).

In summary, the phase plane plot shows the energy exchange perfectly. Potential energy is maximized at the extrema of  $Y$  and kinetic energy at the extrema of  $X$ . The harmonic behavior of the system moving between the two states shows a loop around the origin. The numbers on the phase plane indicate time markers in minutes, hours, months, days, etc. (Vines, 2005).

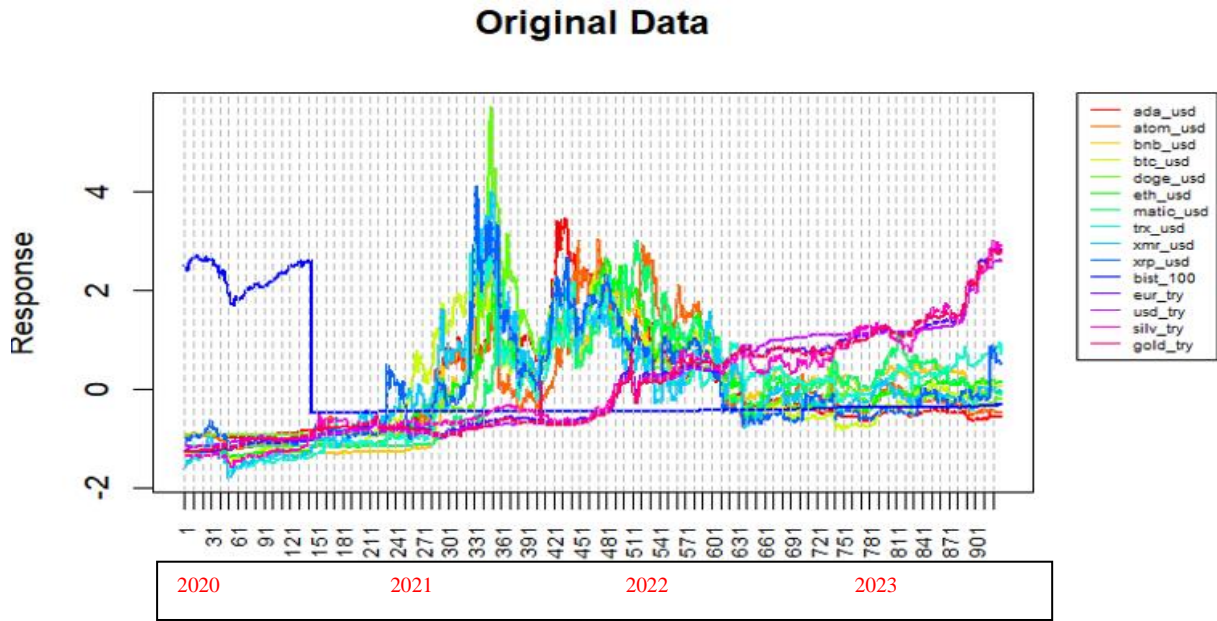
For phase plane plots it is necessary to use the first two derivatives of the curve values in addition to the curve values themselves. Here a method is used to obtain the curves that gives useful estimates of the first and second derivatives of the velocity and acceleration as well as the curve itself. In addition, in order to minimize errors in estimating the axis cut points of the phase plane trajectory, the trajectory must be a smooth curve. For these purposes, before generating the phase plane plots, the prior time series

should be transformed into a smooth curve using the basis functions mentioned in the functional data analysis section. In general, B-Splayn basis functions work very well for non-periodic data such as we have here.

## RESULTS

In this study, the energy changes of 10 cryptocurrencies (Btc, Eth, Bnb, Trx, Xrp, Xmr, Matic, Doge, Atom, Ada coin) as well as the BIST -100, silver, gold, dollar and euro exchange rates were examined and the behavioral changes especially during crisis periods were focused on. While the points where the potential energy is high indicate the periods when the investment instruments reach a saturation, the points where the kinetic energy is intense indicate the periods of high trading movements. The kinetic energy is expected to be high especially in periods of crisis expectations or post-crisis periods.

Figure 1 shows the original curves of the analyzed investment instruments obtained through B-Splayn basis functions.



**Figure 1.** Original curves of investment instruments

When the original curves in Figure 1 are analyzed, the period from approximately the beginning of 2021 (day 261) until the end of the first quarter of 2022 (day 631) is of interest. It is clearly seen that the reason for such a different movement of the data in this period is the global supply chain crisis in 2021. The event that led to the global supply chain crisis was the Covid-19 pandemic, which emerged in Wuhan, China in late 2019, turned into a pandemic in 2020, and then caused major economic impacts all over the world and in Turkey (Küçükoglu, 2021).

Due to Covid-19, policies such as increasing economic support packages in the country, extending the term of overdue loans, and facilitating the public's access to loans show that the tendency towards new investment instruments has increased. During this crisis period, the interest of investors in cryptocurrencies reached its highest levels both in Turkey and in the world, and Bitcoin reached its highest value.

In order to observe the ups and downs of the curves more easily, the first derivative curves giving the velocity are given in Figure 2 and the second derivative curves giving the acceleration are given in Figure 3.



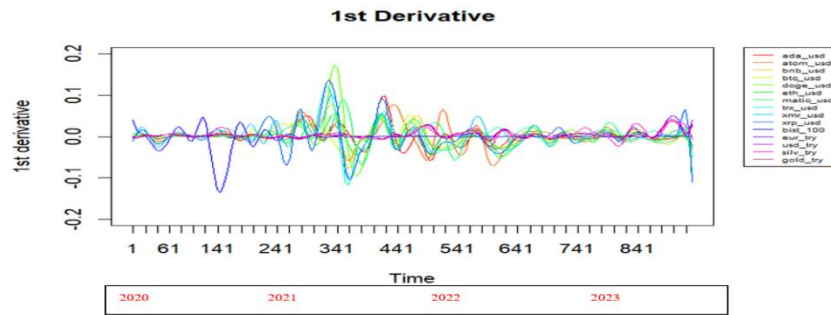


Figure 2. Investment instruments first derivative curves

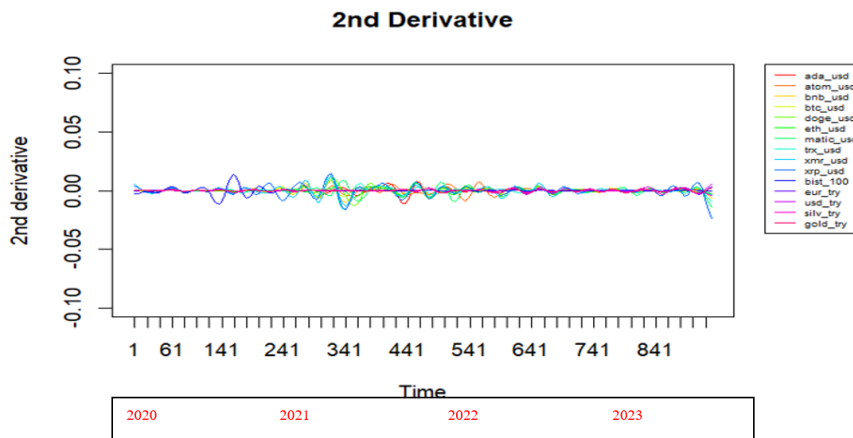


Figure 3. Investment instruments second derivative curves

When the curves in Figures 1, 2 and 3 are analyzed together, for example, it is seen that the BIST-100 curve reached a positive maximum value in the first derivative around day 116, in other words, the rate of increase was maximum. At this point, the potential energy of the BIST-100 represented by the second derivative, in other words, the acceleration is zero. Around day 147, the first derivative reaches a maximum value in the negative sense, i.e. the rate of decline is maximum, and the original curves show a sharp decline at this point. At this point, the potential energy indicated by the second derivative is also zero. However, interpretations can be determined much more easily from the phase planes.

The phase planes for all investment instruments are presented collectively in Figure 4 for easier comparison.

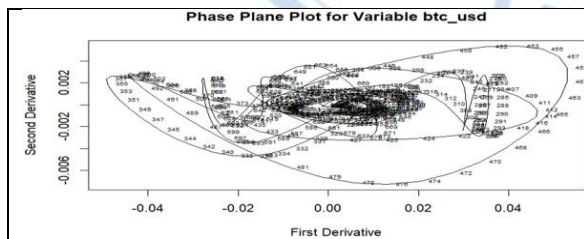


Figure 4.1.Bitcoin Phase Plane

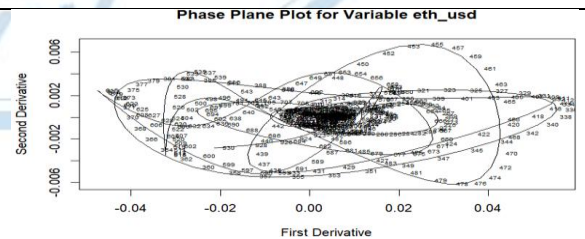
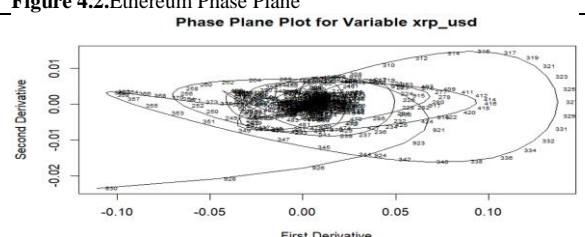
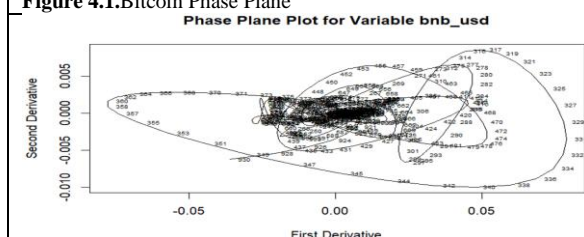
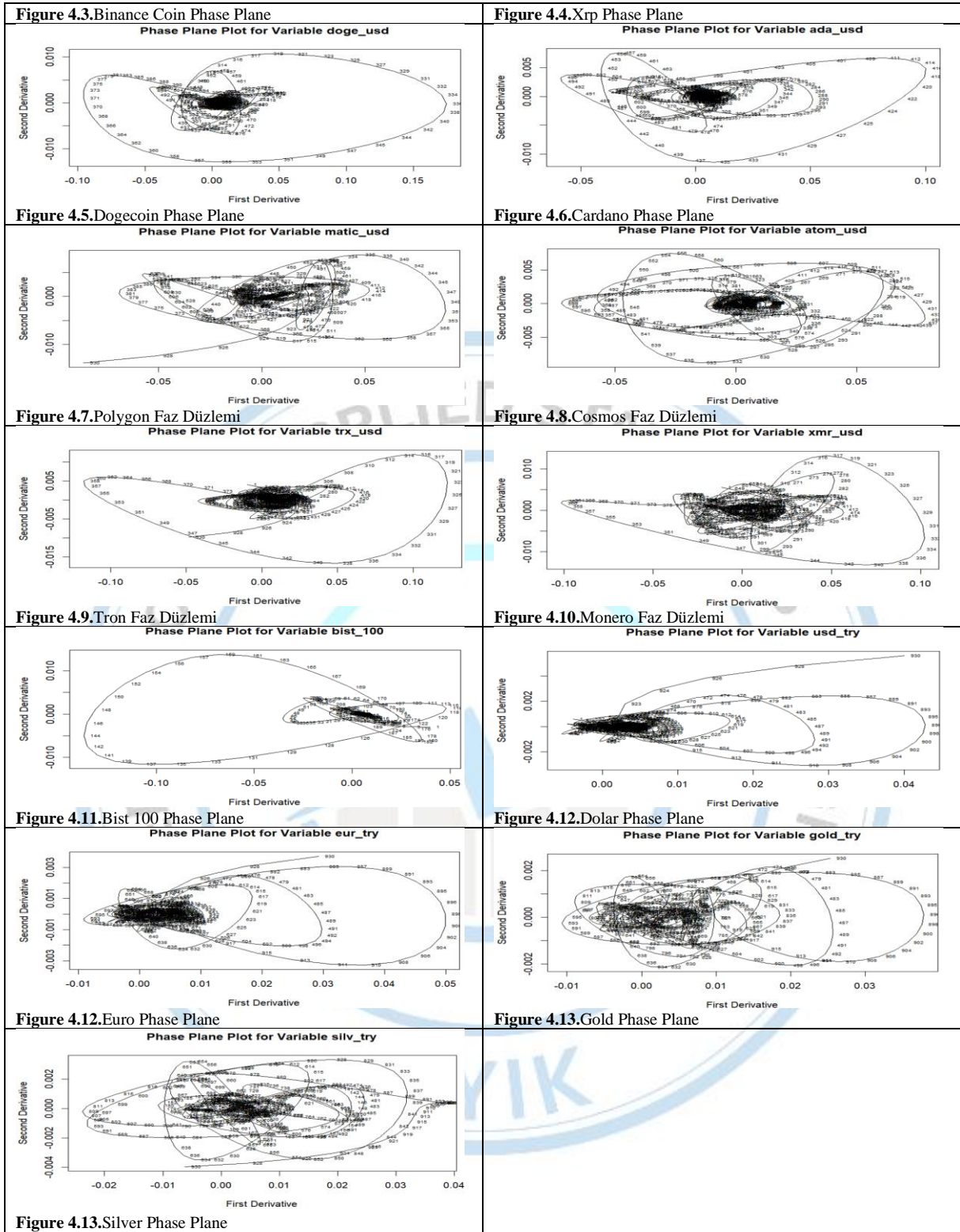


Figure 4.2.Ethereum Phase Plane





**Figure 4.** Phase planes of investment instruments

From the original curve, it is very difficult to identify the points where the kinetic energy and potential energy are minimum and maximum. These points can be observed much more easily through the phase planes given in Figure 4. As a result of these observations, more grounded decisions can be made for the investment to be made. The points where increases and decreases are expected are actually expected to be the points where the potential energy is maximum (Köymen Keser, 2015).

Let's take the Bitcoin phase plane in Figure 4.1 as an example of the interpretation of phase planes

from cryptocurrencies. When the data between 01.01.2020 - 31.07.2023 in Figure 4.1 is analyzed, it is seen that the energy cycles are large between these years. It is seen that the cycle frequency and energy transitions are large. It is seen that the radius of the cycles is large, and the high radius indicates that there are sharp price movements in the long term. On the X-axis, it is observed that the kinetic energy increases positively between day 391 and day 441, reaches a maximum value on day 463 and again reaches a regional maximum on day 411, in other words, buying increases in this period, while the kinetic energy increases negatively between day 331 and day 481, in other words, selling increases in this period. The center of the cycle is to the right, indicating a net positive velocity. Too many transitions between kinetic energy and potential energy on the phase plane are risky for investors. Although kinetic energy seems to be a bit more dominant in the positive sense when looking at the cycles (the rate of increase is higher), it can be said that the fact that there are more ups and downs (volatile), that is, the cycles are too wide, carries a risk for the investor. However, it can be said that this variability is less than other cryptocurrencies.

Among other investment instruments, when the phase plane of the dollar in Figure 4.12 is examined, it is seen that the center of the cycle on the phase plane is to the right and the net positive rate increases. Especially after the 463rd day, 873rd day and 923rd day, it is seen that the rate of increase has increased at very high rates. Throughout the period analyzed in the data, it is seen that the kinetic energy in a positive sense has experienced a continuous increase and has caught an upward trend. Based on these cycles, the dollar appears to be an investment instrument with a minimum level of risk compared to all other investment instruments analyzed. It can be said to be one of the investment instruments that offer short-term buy and sell opportunities. When evaluated in terms of risk, it is clearly seen that the rate of increase is higher while the rate of decrease is lower.

## **DISCUSSION AND CONCLUSION**

People are looking for a variety of investment instruments to utilize what they have earned over the years or to protect the value of their money against economic problems in their countries. The increasing interest in cryptocurrencies in recent years has significantly increased the volume in the market. Cryptocurrencies, which are just starting to be preferred as investment instruments, do not have a very positive perception from the outside. It is a market that is not dominated by investors who generally prefer classical investment instruments and are far from blockchain technology. Especially the sudden ups and downs in times of crisis, the collapse of some crypto exchanges and the collapse of known coins such as Luna have caused a concern when investing on the crypto side.

But do cryptocurrencies really go up and down so sharply? By examining the potential and kinetic energy changes on the phase planes, the cycles on these planes have been a very convenient method to answer this question. In the study, the BIST-100 index, US dollar and Euro exchange rates were analyzed along with cryptocurrencies. In the study, by using the relationship between potential and kinetic energy, the risk levels for investors are examined in order to provide a direction for the choices to be made by investors.

The wider the phase plane trajectory of a variable, the more intense the exchange of potential and kinetic energy, which can be a reason for preference for risk-loving investors and a disadvantage for risk-averse investors. Here, it is seen that the phase cycles of cryptocurrencies are much wider than other investment instruments. Especially when the dollar and the euro are analyzed, it can be clearly seen that while the rate of increase of the curves is high, the rate of decrease is much slower.

Although there are studies in the literature on cryptocurrencies and the volatility of cryptocurrencies (Bhosale and Mavale, 2018; Doumenis et al., 2021; Berentsen and Schär, 2019; Alıca et al., 2023; Öncü and Ektik, 2021), there is no study that compares cryptocurrencies with other investment instruments and examines them in terms of the phase plane and makes a risk recommendation in this sense. The unique value of this study is that it examines the rate of increase and decrease and takes into account the



behavior of crisis periods.

### References

- Alica S, Özbek Ö, Gökçe A, 2023. Kripto Para Birimleri Arasındaki Dinamik İlişkiler. Ankara Hacı Bayram Veli Üniversitesi İktisadi ve İdari Bilimler Fakültesi Dergisi, 25(1): 325-342.
- Allen J, 2011. Comparison of Time Series and Functional Data Analysis for the Study of Personality, Master Thesis. East Tennessee University, the faculty of the Department of Mathematics, USA.
- Amarasinghe AAMD, Dharmaratne DG, 2014. Dynamic relationship between Exchange rate and Stock Returns; Empirical Evidence from Colombo Stock Exchange. International Journal of Liberal Arts and Social Science, 2(5): 129-137.
- Berentsen A, Schär F, 2019. Stablecoins: The quest for a low-volatility cryptocurrency. The economics of Fintech and digital currencies: 65-75.
- Bhosale J, Mavale S, 2018. Volatility of select crypto-currencies: A comparison of Bitcoin, Ethereum and Litecoin, Annu. Res. J. SCMS, Pune, 6(1): 132-141.
- Deniz EA, 2020. Finansal Piyasalarda Kripto Para Uygulamaları: Kripto Para Fiyatlarını Etkileyen Faktörler, Master Thesis. Işık University, Social Sciences Institute, İstanbul, Turkey.
- Doumenis Y, Izadi J, Dhamdhare P, Katsikas E, Koufopoulos D, 2021. A critical analysis of volatility surprise in Bitcoin cryptocurrency and other financial assets. Risks, 9(11): 207.
- Köymen Keser İ, 2015. Döviz Kuru ve Hisse Senedi Enerji Değişimlerinin Faz Düzlemleri Aracılığıyla İncelenmesi. İstatistikçiler Dergisi: İstatistik ve Aktüerya, 8(2): 36-57.
- Küçüköğlü S, 2021. Kripto Para ve Kripto Paranın Muhasebeleştirilmesi: Kripto Para Birimleri İle İlgili Düzenlemelerin Dünya’da ve Türkiye’de İncelenmesi. İstanbul Ticaret Üniversitesi. Sosyal Bilimler Dergisi, 20(42):1269-1291.
- Moreland K, 2019. The History of Bitcoin and Cryptocurrencies: Explained. Access address: <https://www.ledger.com/academy/crypto/a-brief-history-on-bitcoin-cryptocurrencies>; Date of access: 10.08.2023.
- Öncü S, Ektik D, 2021. Kripto paraların yatırım amaçlı kullanımı: riskler ve getiriler. Manisa Celal Bayar Üniversitesi Sosyal Bilimler Dergisi, 19(4):362-395.
- Vines BW, Nuzzo RL, Levitin DJ, 2005. Analyzing Temporal Dynamics in Music: Differential Calculus, Physics, and Functional Data Analysis Techniques. Music Perception, 23(2): 137-152.
- West RM, Harris K, Gilthorpe MS, Tolman C, Will EJ, 2007. Functional Data Analysis Applied to a Randomized Controlled Clinical Trial in Haemodialysis Patients Describes the Variability of Patient Responses in the Control of Renal Anaemia. Journal of the American Society of Nephrology, 18(8): 2371- 2376.

### Conflict of Interest

“The authors have declared that there is no conflict of interest”.

### Author Contributions

The authors contributed equally to the study.

## Ekonomik Büyüme ve Karbondioksit Emisyonu Arasındaki İlişkide Çevresel Kuznets Eğrisi Hipotezinin E7 Ülkeleri için Karşılaştırmalı Analizi<sup>1</sup>

Uğur Ayık<sup>1\*</sup>, Hüseyin ÖZER<sup>2</sup>

<sup>1</sup>Erzurum Teknik Üniversitesi, 25050, Erzurum, Türkiye

<sup>2</sup>Atatürk Üniversitesi, İİBF, Ekonometri, 25240, Erzurum, Türkiye

\*Sorumlu yazar e-mail: ugur.ayik@erzurum.edu.tr

### Özet

Kimyasalların ve atıkların insan sağlığı ve çevre üzerindeki olumsuz etkilerini en aza indirgeyecek sorumlu bir üretimin gerçekleştirilmesi, Birleşmiş Milletler'in (BM) belirlediği Sürdürülebilir Kalkınma Amaçları arasında yerini almıştır (SDG-12: Sorumlu Üretim ve Tüketim). Bu çalışmanın temel amacı 1965-2021 dönemini kapsayan zaman serisini kullanarak E7 ülkeleri için karbondioksit emisyonu ile ekonomik büyüme arasındaki ilişkinin yönünü ve mahiyetini belirlemektir. Serilerin durağanlık seviyesini belirlemek için Kwiatkowski, Phillips, Scmidth ve Shin (KPSS) ve Zivot-Andrews (ZA) birim kök testleri uygulanmıştır. Genel ÇKE modelinden türetilen altı model spesifikasyonuna ait regresyon tahmin sonuçları ve değişkenler arasındaki eşbütünlük ilişkilerinin araştırıldığı Ardışık Bağımlı Dağıtılmış Gecikme (Autoregressive Distributed Lag, ARDL) Sınır Testi sonuçları baz alınarak E7 ülkeleri için en uygun çevre-gelir modelleri seçilmeye çalışılmıştır. Bu kapsamda karbondioksit emisyonu-gelir ilişkisi biçimi, Türkiye ve Hindistan için 'N', Çin için 'U' ve Rusya için ise ters 'N' şeklinde tespit edilmiştir. Brezilya ve Meksika için karbondioksit emisyonu-gelir ilişkisinde artan lineer formda bir ilişki biçiminin ortaya çıktığı görülmüş olup söz konusu değişkenler arasında ÇKE hipotezi (ters 'U' ilişkisi) sadece Endonezya için geçerli bulunmuştur.

**Anahtar Kelimeler:** Karbondioksit Emisyonu, Ekonomik Büyüme, Sürdürülebilirlik, ÇKE Hipotezi, ARDL Sınır Testi

### GİRİŞ

Dünya ekonomisinde son yıllarda hızlı bir dönüşüm yaşanmış olup Covid-19 salgını sonrası çevresel sonuçlar ve yüksek enerji talebiyle küresel ekonominin toparlanma sürecine gireceği beklenmektedir. Küresel ekonominin büyüme süreci üzerinde gelişmiş yedi piyasa ekonomisinin (the Group of Seven, G7) yanı sıra gelişmekte olan en büyük yedi piyasa ekonomisi (the Seven Largest Emerging Market Economies, E7) de önemli etki oluşturmaktadır. E7 ekonomilerinin son yirmi yılda yaşadığı olağanüstü büyüme, G7 ekonomilerini yakalamalarını sağlamış fakat E7 ülkelerinin ekonomik olarak bu denli büyümeleri artan enerji taleplerinden dolayı çevresel risklere karşı daha duyarlı olmaları gerektiği durumunu gündeme getirmiştir. Özellikle Çin ve Hindistan'ın enerji taleplerinin yıldan yıla katlanarak artması, diğer E7 ülkelerinin de en önemli kirleticiler arasında yer alması, söz konusu ekonomileri fosil yakıt bağımlılığının azaltılarak enerji geçişinin sağlanması noktasında önemli bir sorunla yüzleştirmektedir (Doğan vd., 2022).

Karbondioksit emisyonu ile ekonomik büyüme arasındaki ilişkileri araştırmak için üç temel model sınanmaktadır. Bunlar; lineer, kuadratik ve kübik modellerdir (Shafik ve Bandyopadhyay, 1992). Bu çalışmanın temel amacı, E7 ülkelerinde ekonomik büyümenin artması çevre kirliliği için bir problem midir (ÇKE konseptinin geçerli olmaması) yoksa çözüm müdür (ÇKE konseptinin geçerli olması) sorusunun cevabını ampirik analizlerle sorgulamaktır. Bu amaç doğrultusunda, kuadratik ÇKE modeli

<sup>1</sup> Bu çalışma, birinci yazarın ikinci yazar danışmanlığında hazırladığı doktora tezinden üretilmiştir.

alternatif modellere (lineer ve kübik) karşı sınanmıştır. Yapılan analizlerde 1965-2021 dönemini kapsayan zaman serileri kullanılmıştır. Bu çalışma daha önce dünyada yapılmış olan çalışmalardan birtakım farklılıklar içermektedir. Gelirin dışında karbondioksit emisyonu üzerinde önemli etki barındırdığı düşünülen dört önemli değişken (fosil yakıt tüketimi, alternatif enerji (örneğin, güneş enerjisi) tüketimi, hizmet sektörünün katma değerinin GSYH içindeki payı, doğrudan yabancı yatırımın GSYH içindeki payı) CO<sub>2</sub>-gelir modeline dahil edilerek genel bir çevre formülasyonu oluşturulmuş, daha sonra oluşturulan bu genel formülasyondan altı model spesifikasyonu (temel modeller, genişletilmiş modeller) türetilmiştir. İhmal edilen değişkenlerin CO<sub>2</sub>-gelir ilişki biçimi üzerinde oluşturacağı etkiyi ortaya koyabilmek için türetilen bu altı model spesifikasyonundan ilk üçünde (temel modeller) genel çevre modelinde yer alan gelir dışındaki değişkenlere yer verilmemiştir, türetilen diğer modellerde (genişletilmiş modeller) ise söz konusu dört değişken modellere alınmıştır. Ayrıca, literatürde CO<sub>2</sub> ile ekonomik büyüme arasındaki ilişkilerde genellikle kuadratik formun dikkate alındığı gözlemlenmiş olup bu çalışmada kuadratik formun yanı sıra lineer ve kübik formlarda dikkate alınarak değişkenler arasındaki ilişkilerde muhtemel tüm ilişki biçimleri üzerinde durulmuştur. Netice itibarıyla, E7 ülkeleri için en uygun çevre modellerinin seçim işlemi daha sağlam istatistiki temellere dayandırılarak ÇKE hipotezinin (ters 'U' ilişkisi) söz konusu ülkeler için geçerliliği araştırılmış ve gelecekte yapılacak çalışmalar için kayda değer bir literatür katkısı sunulmuştur.

## MATERYAL VE YÖNTEM

Türkiye, Çin, Hindistan, Brezilya, Meksika ve Endonezya ülkeleri için 1965-2021 dönemini kapsayan zaman serilerinin kullanıldığı çalışmada, Rusya için 1965-1984 dönemine ait veriler temin edilemediğinden 1985-2021 dönemini kapsayan veriler baz alınmıştır. Kişi başına düşen karbondioksit emisyonu verileri BP, Dünya Enerjisinin İstatistiksel İncelemesi ve Dünya Bankası, Dünya Gelişmişlik Göstergeleri veri tabanlarından; kişi başına düşen gelir, fosil yakıt tüketimi, alternatif enerji tüketimi, hizmet sektörünün katma değeri ve doğrudan yabancı yatırım net girişleri değişkenlerine ait veri setleri ise Dünya Bankası, Dünya Gelişmişlik Göstergeleri veri tabanından elde edilmiştir.

Karbondioksit emisyonu ile ekonomik büyüme arasındaki muhtemel ilişkileri incelemek için kurulan genel ÇKE formülasyonu,

$$\ln co2_t = \beta_0 + \beta_1 \ln gsyh_t + \beta_2 (\ln gsyh_t)^2 + \beta_3 (\ln gsyh_t)^3 + \beta_4 \ln co2_{t-1} + \beta_5 yıl + \beta_6 \ln fyt_t + \beta_7 \ln aet_t + \beta_8 \ln h_t + \beta_9 \ln dyy_t + e_t \quad (1)$$

biçimindedir. Burada;  $\ln co2_t$  kişi başına düşen karbondioksit salınımını (metrik ton olarak),  $\ln gsyh_t$  kişi başına düşen geliri (cari ABD doları olarak),  $\ln fyt_t$  fosil yakıt tüketimini (toplam enerji tüketiminin yüzdesi olarak),  $\ln aet_t$  alternatif enerji (güneş enerjisi, rüzgar enerjisi vb.) tüketimini (toplam enerji tüketiminin yüzdesi olarak),  $\ln h_t$  hizmet sektörünün katma değerini (GSYH'nin yüzdesi olarak),  $\ln dyy_t$  doğrudan yabancı yatırım net girişlerini (GSYH'nin yüzdesi olarak),  $yıl$  değişkeni deterministik zaman endeksini ve  $e_t$  ise hata terimini ifade etmektedir.<sup>2</sup>

Karbondioksit salınımı ile gelir arasındaki muhtemel ilişkileri gösteren genel ÇKE formülasyonundaki katsayılarla ait beklenen işaretler Tablo 1'de sunulmaktadır (De Bruyn vd., 1998).

**Tablo 1. Muhtemel Karbondioksit-Gelir İlişkisinde Katsayıların Beklenen İşaretleri**

Karbondioksit Salınımı-Gelir İlişkisi	Katsayıların Beklenen İşaretleri
Lineer: Artan	$\beta_1 > 0$ ve $\beta_2 = \beta_3 = 0$
Lineer: Azalan	$\beta_1 < 0$ ve $\beta_2 = \beta_3 = 0$
Kuadratik: Ters 'U' şeklinde	$\beta_1 > 0, \beta_2 < 0$ ve $\beta_3 = 0$
Kuadratik: 'U' şeklinde	$\beta_1 < 0, \beta_2 > 0$ ve $\beta_3 = 0$
Kübik: 'N' şeklinde	$\beta_1 > 0, \beta_2 < 0$ ve $\beta_3 > 0$
Kübik: Ters 'N' şeklinde	$\beta_1 < 0, \beta_2 > 0$ ve $\beta_3 < 0$

<sup>2</sup> Serileri olası değişen varyans ve kısmen de otokorelasyona karşı korumak amacıyla modelde  $yıl$  değişkeni haricindeki tüm değişkenlerin doğal logaritmaları ( $\ln$ ) alınmıştır (Tari, 2018). Çalışmadaki ekonometrik analizler EViews 9 programı kullanılarak gerçekleştirilmiştir.



$lnco2_{t-1}$  ve  $yil$  değişkenleri ise sırasıyla, kişi başına düşen karbondioksit salınımindaki kalıcılığı ve deterministik trendi hesaplamak için genel ÇKE modeline dahil edilmiştir. Kalıcılık,  $|\beta_4| < 1$  olması durumunda, karbondioksit salınımına ait cari dönem değerlerinin geçmiş dönem değerleri tarafından yönlendirildiği anlamına gelmektedir. Ayrıca, istatistik olarak anlamlı bir  $yil$  değişkeni ise yalnızca zamanın geçmesine bağlı olarak değişen salınımların (yıldan yıla farklılık gösterdiklerinin) bir göstergesidir.

E7 ülkeleri için karbon emisyonu ile gelir arasındaki ilişkinin yönünün ve mahiyetinin daha sağlıklı bir şekilde test edilebilmesine yönelik (1) nolu genel ÇKE modelinin altı varyasyonu oluşturulmuştur. Oluşturulan bu altı modelden ilk üçü temel modeller, diğer üçü ise genişletilmiş modellerdir. Model (2), Model (3) ve Model (4) karbondioksit salınımı-gelir ilişkisinin lineer, kuadratik ve kübik spesifikasyonlarına karşılık gelen temel modellerdir. Model (2a), Model (3a) ve Model (4a) ise sırasıyla lineer, kuadratik ve kübik modellerin (Model 2-4) genişletilmiş formlarını ifade etmektedir.

$$lnco2_t = \alpha_0 + \alpha_1 lngsyh_t + \alpha_2 lnco2_{t-1} + \alpha_3 yil + e_{1t} \quad (2)$$

$$lnco2_t = \beta_0 + \beta_1 lngsyh_t + \beta_2 (lngsyh_t)^2 + \beta_3 lnco2_{t-1} + \beta_4 yil + e_{2t} \quad (3)$$

$$lnco2_t = \gamma_0 + \gamma_1 lngsyh_t + \gamma_2 (lngsyh_t)^2 + \gamma_3 (lngsyh_t)^3 + \gamma_4 lnco2_{t-1} + \gamma_5 yil + e_{3t} \quad (4)$$

$$lnco2_t = \delta_0 + \delta_1 lngsyh_t + \delta_2 lnco2_{t-1} + \delta_3 yil + \delta_4 lnfyt_t + \delta_5 lnaet_t + \delta_6 lnht_t + \delta_7 lndyy_t + e_{4t} \quad (2a)$$

$$lnco2_t = \theta_0 + \theta_1 lngsyh_t + \theta_2 (lngsyh_t)^2 + \theta_3 lnco2_{t-1} + \theta_4 yil + \theta_5 lnfyt_t + \theta_6 lnaet_t + \theta_7 lnht_t + \theta_8 lndyy_t + e_{5t} \quad (3a)$$

$$lnco2_t = \lambda_0 + \lambda_1 lngsyh_t + \lambda_2 (lngsyh_t)^2 + \lambda_3 (lngsyh_t)^3 + \lambda_4 lnco2_{t-1} + \lambda_5 yil + \lambda_6 lnfyt_t + \lambda_7 lnaet_t + \lambda_8 lnht_t + \lambda_9 lndyy_t + e_{6t} \quad (4a)$$

Çalışmada kullanılan veriler, genel ÇKE modeli ve bu modelden türetilen altı model spesifikasyonuna ait teorik çerçeve tanıtıldıktan sonra serilerin durağanlık seviyelerini belirlemek için birim kök testleri ve seriler arasında uzun dönemli ilişkilerin varlığını test etmek için ARDL Sınır Testi uygulanmıştır.

## BULGULAR

### Birim Kök Test Sonuçları

Serilerin durağanlık mertebelerini tespit etmek için geleneksel birim kök testleri adına KPSS Birim Kök Testi, yapısal kırılmaları dikkate alan birim kök testlerinden ise ZA Birim Kök Testi uygulanarak elde edilen durağanlık sonuçları karşılaştırılmıştır.

V. INTERNATIONAL APPLIED STATISTICS CONGRESS (UYİK - 2024)  
İstanbul / Türkiye, May 21-23, 2024

Tablo 2. KPSS Birim Kök Test Sonuçları (LM-istatistiği)

	Değişken	Türkiye	Çin	Hindistan	Brezilya	Meksika	Endonezya	Rusya	
Sabitli	$lnco2_t$	0.9078	0.9050	0.9112	0.8194	0.7340	0.8952	<b>0.4271*</b>	
	$\Delta lnco2_t$	0.4186*	0.1243*	0.1778*	0.3261*	0.4230*	0.2667*	0.2683*	
	$lngsyh_t$	0.8852	0.8874	0.8868	0.8577	0.8763	0.8456	0.5012	
	$\Delta lngsyh_t$	0.1376*	0.4617*	0.1964*	0.2031*	0.2987*	0.1894*	0.1702*	
	$lnfyt_t$	0.9139	0.8324	0.8168	<b>0.4558*</b>	<b>0.3018*</b>	0.7529	0.6171	
	$\Delta lnfyt_t$	0.4480*	0.2959*	0.3243*	0.1111*	0.2181*	0.4425*	0.4037*	
	$lnaet_t$	0.8055	0.8225	<b>0.1676*</b>	0.6085	<b>0.0599*</b>	<b>0.3723*</b>	0.6673	
	$\Delta lnaet_t$	0.1391*	0.1310*	0.1291*	0.4452*	0.0461*	0.0990*	0.4485*	
	$lnh_t$	0.7839	0.8550	0.8472	0.7467	0.6471	<b>0.3110*</b>	0.5799	
	$\Delta lnh_t$	0.4499*	0.2608*	0.2790*	0.0691*	0.0627*	0.1000*	0.4262*	
	$lndyy_t$	0.7737	0.5228	0.8534	0.6002	0.8444	<b>0.2356*</b>	<b>0.3260*</b>	
	$\Delta lndyy_t$	0.2270*	0.4502*	0.1806*	0.0770*	0.0787*	0.0613*	0.0713*	
	Sabitli ve Trendli	$lnco2_t$	0.2087	<b>0.0719*</b>	<b>0.1174*</b>	<b>0.1135*</b>	0.2388	0.2270	0.1602
		$\Delta lnco2_t$	0.0778*	0.0636*	0.0964*	0.0928*	0.0788*	0.1237*	0.0778*
$lngsyh_t$		<b>0.0719*</b>	0.2225	0.1464	<b>0.0939*</b>	0.1965	<b>0.0996*</b>	<b>0.1090*</b>	
$\Delta lngsyh_t$		0.0560*	0.0924*	0.0735*	0.0496*	0.1188*	0.0850*	0.1343*	
$lnfyt_t$		0.1603	<b>0.1272*</b>	0.1939	<b>0.0576*</b>	<b>0.0999*</b>	0.2017	0.2270	
$\Delta lnfyt_t$		0.1075*	0.0694*	0.1394*	0.0868*	0.1624	0.1686	0.5000	
$lnaet_t$		0.1934	0.1735	<b>0.1254*</b>	0.2078	<b>0.0569*</b>	<b>0.1216*</b>	0.1912	
$\Delta lnaet_t$		0.1178*	0.0360*	0.1211*	0.0882*	0.0447*	0.0620*	0.1200*	
$lnh_t$		0.2250	<b>0.1230*</b>	0.1992	<b>0.1116*</b>	<b>0.0638*</b>	0.1524	0.1589	
$\Delta lnh_t$		0.0667*	0.1102*	0.1285*	0.0600*	0.0629*	0.1281*	0.1240*	
$lndyy_t$		<b>0.0838*</b>	0.2264	<b>0.1150*</b>	<b>0.1134*</b>	0.1747	<b>0.1104*</b>	0.1730	
$\Delta lndyy_t$		0.0723*	0.1254*	0.0185*	0.0720*	0.0701*	0.0757*	0.0841*	

$\Delta$ , fark alma işlemcisini; \*, 0.05 önem düzeyinde serinin durağan olduğunu ifade etmektedir. Kwiatkowski vd. (1992)'de 0.05 önem düzeyinde kritik değer sabitli model için 0.4630 ve sabitli ve trendli model için 0.1460'dır.

Tablo 3. ZA Birim Kök Test Sonuçları (t-istatistiği (TB))

	Değişken	Türkiye	Çin	Hindistan	Brezilya	Meksika	Endonezya	Rusya
Sabitte Kıvrılma (Model A)	$lnco2_t$	-3.2548 (2001)	<b>-5.1030*</b> (2003)	-3.0384 (1977)	-4.1391 (1987)	-0.5988 (2012)	-2.4950 (1975)	-4.3694 (1993)
	$\Delta lnco2_t$	-8.7762* (1978)	-5.3840* (2001)	-8.9492* (1979)	-4.9883* (1975)	-7.8580* (1997)	-5.2545* (1986)	-4.9416* (1998)
	$lngsyh_t$	-2.9346 (2013)	-3.2332 (2004)	-4.3946 (1991)	-3.0513 (2013)	-2.4439 (2011)	-4.2488 (1997)	-3.3224 (2004)
	$\Delta lngsyh_t$	-7.3821* (2009)	-6.9622* (2012)	-9.1646* (2003)	-5.4720* (2003)	-7.4525* (1982)	-7.3923* (1999)	-5.3552* (2000)
	$lnfyt_t$	-3.7527 (1985)	-2.6575 (2003)	-2.9550 (1981)	-4.5279 (1995)	-3.6854 (1990)	-3.7722 (1986)	-3.0526 (2000)
	$\Delta lnfyt_t$	-7.5139* (1974)	-4.9657* (2008)	-8.1328* (1979)	-4.9650* (1979)	-8.3382* (1982)	-8.0837* (1979)	-5.4982* (2000)
	$lnaet_t$	<b>-5.2054*</b> (1975)	-3.4357 (1990)	-4.1898 (1990)	-1.4299 (2008)	<b>-5.0500*</b> (1990)	-3.6784 (1982)	-2.9402 (2010)
	$\Delta lnaet_t$	-7.3363* (1989)	-5.7802* (1993)	-9.2393* (1979)	-8.7107* (1986)	-8.5339* (1990)	-7.1614* (1990)	-5.5000* (2002)
	$lnh_t$	-3.0576 (1976)	-3.9217 (1985)	<b>-5.2807*</b> (1997)	<b>-5.2383*</b> (1989)	<b>-4.9898*</b> (1980)	-3.5685 (1985)	-3.6173 (2004)
	$\Delta lnh_t$	-9.4465* (1981)	-4.9897* (1983)	-7.2022* (2003)	-8.6001* (1994)	-5.0528* (1980)	-6.5623* (1996)	-5.6250* (2009)
	$lndyy_t$	-3.6513 (1976)	<b>-7.4090*</b> (1992)	-4.7133 (1993)	-4.3905 (1996)	-3.6751 (2009)	-2.2689 (1990)	-3.4766 (2014)
	$\Delta lndyy_t$	-10.909* (1978)	-7.7852* (1994)	-5.2125* (1995)	-8.3422* (1992)	-5.5364* (1994)	-5.2835* (1983)	-6.0254* (2006)

V. INTERNATIONAL APPLIED STATISTICS CONGRESS (UYİK - 2024)  
İstanbul / Türkiye, May 21-23, 2024

Tablo 3. Devamı

	Değişken	Türkiye	Çin	Hindistan	Brezilya	Meksika	Endonezya	Rusya	
Trendde Kırılma (Model B)	$lnco_2$	-3.7708 (1990)	-2.7867 (1996)	-3.0366 (1979)	-4.2829 (2013)	-1.6090 (2012)	-3.7847 (1998)	<b>-4.8949*</b> (1997)	
	$\Delta lnco_2$	-8.1775* (1980)	-5.3857* (2007)	-4.8652* (2012)	-4.5587* (1981)	-8.2664* (2012)	-7.5740* (1984)	-4.7145* (1993)	
	$lngsyh_t$	-4.0762 (2013)	-2.9512 (1988)	-2.5347 (1999)	-3.8630 (2013)	-2.8853 (2005)	-3.2880 (2001)	-2.6357 (2012)	
	$\Delta lngsyh_t$	-7.1399* (2006)	-6.7599* (2009)	-8.3160* (1992)	-5.0442* (1982)	-6.8676* (1985)	-7.0588* (1984)	-4.4852* (2005)	
	$lnfy_t$	-3.9136 (2008)	-2.8006 (2009)	-3.9559 (1993)	-3.8607 (1984)	-3.6258 (1996)	<b>-4.8006*</b> (1996)	-2.9780 (2005)	
	$\Delta lnfy_t$	-6.7520* (2008)	-4.9472* (2006)	-7.0763* (1983)	-5.0013* (1981)	-7.9467* (1987)	-7.8435* (1983)	-5.9811* (2002)	
	$lnaet_t$	<b>-4.7060*</b> (1980)	-3.8659 (1991)	-3.2875 (2000)	-2.2457 (2008)	-3.3882 (1987)	-3.2005 (1984)	<b>-4.4752*</b> (2003)	
	$\Delta lnaet_t$	-6.8469* (2001)	-5.3681* (1995)	-9.1675* (1988)	-8.0820* (1987)	-7.6826* (1991)	-5.5854* (1983)	-4.9672* (2011)	
	$lnh_t$	-3.9341 (1981)	-3.5404 (2000)	-3.6291 (1981)	-2.9629 (1993)	-3.7643 (1982)	-4.1165 (2001)	<b>-4.7664*</b> (2017)	
	$\Delta lnh_t$	-8.1169* (1987)	-5.9254* (1986)	-7.1179* (2000)	-6.7815* (1990)	-8.3114* (2013)	-6.3171* (2015)	-6.4091* (2015)	
	$lndyy_t$	-4.4005 (2009)	-4.0870 (1994)	-3.6331 (2009)	-2.9440 (1987)	-3.5786 (2002)	-3.6894 (1997)	<b>-5.6896*</b> (2008)	
	$\Delta lndyy_t$	-10.4685* (1985)	-4.8685* (2012)	-7.0373* (2015)	-7.3846* (1998)	-8.5291* (1996)	-4.9858* (1995)	-6.0733* (2016)	
	Sabitte ve Trendde Kırılma (Model C)	$lnco_2$	-3.9014 (2001)	-4.7599 (2003)	-3.4852 (1982)	-4.7393 (2010)	-1.5741 (2012)	-3.4678 (1999)	-4.8311 (1993)
		$\Delta lnco_2$	-8.6353* (1982)	-5.2279* (2002)	-5.8544* (2007)	-5.1035* (1984)	-8.3709* (2011)	-7.9858* (1989)	-6.0923* (1998)
$lngsyh_t$		-4.7222 (2010)	-3.3896 (1986)	-4.7841 (1991)	-4.7517 (2010)	-2.8636 (2000)	-3.6752 (2006)	-2.7395 (2010)	
$\Delta lngsyh_t$		-7.5474* (2003)	-6.9329* (2006)	-9.4260* (2003)	-5.5476* (2003)	-7.5676* (1987)	-7.4401* (1999)	-5.3208* (2000)	
$lnfy_t$		-3.8995 (2007)	-3.2700 (2009)	-3.4554 (1994)	-4.4439 (1995)	-3.9121 (1995)	-4.7671 (1998)	-3.6096 (2000)	
$\Delta lnfy_t$		-7.6636* (1980)	-5.5533* (2003)	-8.0107* (1979)	-6.3569* (1985)	-8.2942* (1997)	-7.9857* (1984)	-6.5489* (1999)	
$lnaet_t$		-4.6856 (1986)	-4.8357 (1994)	-4.0869 (1990)	-2.0729 (2008)	<b>-5.6520*</b> (1990)	<b>-8.6786*</b> (1990)	-4.4743 (1999)	
$\Delta lnaet_t$		-7.0937* (1989)	-6.0461* (1992)	-9.2738* (1994)	-8.5965* (1986)	-8.4204* (1990)	-6.8321* (1989)	-6.1919* (2011)	
$lnh_t$		-2.6586 (1987)	-4.9053 (1984)	-4.5839 (1997)	-5.0144 (1990)	<b>-5.9074*</b> (1980)	<b>-5.1920*</b> (1998)	<b>-5.4451*</b> (2013)	
$\Delta lnh_t$		-8.6032* (1981)	-6.3038* (1983)	-7.3471* (1997)	-8.4271* (1994)	-9.2341* (1982)	-7.3280* (2001)	-6.7020* (2007)	
$lndyy_t$		-4.9632 (1981)	<b>-6.1583*</b> (1992)	-4.7095 (1992)	-4.8899 (1996)	-3.8135 (1995)	-3.7874 (1998)	<b>-5.7382*</b> (2006)	
$\Delta lndyy_t$		-10.5939* (1990)	-6.3526* (1995)	-7.2330* (1998)	-8.2543* (1992)	-8.8794* (2013)	-5.7201* (2001)	-6.1325* (2014)	

Δ, fark alma işlemcisini; \*, 0.05 önem düzeyinde serinin durağan olduğunu; TB kırılma tarihini ifade etmektedir. Zivot-Andrews (1992)'de 0.05 önem düzeyinde kritik değer Model A için -4.93, Model B için -4.42 ve Model C için -5.08'dir.

KPSS testinde temel hipotez ( $H_0$ ) serinin durağan olduğunu yani birim kök içermediğini ifade ederken, ZA testinde ise temel hipotez ( $H_0$ ) yapısal kırılma olmadan serinin birim kök içerdiğini yani durağan olmadığını ifade etmektedir. ZA Birim Kök Testinde hesaplanan t-istatistik değerlerinin Zivot-Andrews (1992)'de belirlenen kritik değerlerden mutlak değerce büyük olması durumunda temel hipotezin reddedildiğine karar verilir. Bu koşullar altında Tablo 2 ve Tablo 3'te ülke bazında kategorize edilmiş birim kök testi sonuçlarına göre, serilerin  $I(0)$  veya  $I(1)$  sürecine sahip olduğu gözlemlenmektedir. İstisnai durum olarak yalnızca Endonezya ve Rusya'nın  $lnfy_t$  serilerinin sabitli ve trendli KPSS testi sonucunda düzeyde veya birinci farkta durağan olmadığı görülmüş, fakat aynı testin sabitli-trendsiz model tahmini sonucu ve ZA Birim Kök Testi tahmin sonuçlarına göre,  $lnfy_t$  serilerinin birinci farkta durağan hale geldiği yukarıdaki tablolardan anlaşılmaktadır. Çalışmada değerlendirilen serilerin  $I(0)$  ya da  $I(1)$  sürecine sahip olmaları ARDL Sınır Testinin uygulanabilme temel şartını sağlamıştır. ARDL Sınır testi uygulanarak E7 ülkeleri için karbondioksit emisyonu ile ekonomik büyüme değişkenleri arasında uzun dönemli ilişkilerin araştırılmasına geçilmeden önce altı model



spesifikasyonu (Model 2-4 (temel modeller), Model 2a-4a (genişletilmiş modeller)) SEKK Yöntemi ile tahmin edilerek ülkeler bazında çevre kirliliği-gelir ilişkisini en iyi sunan modeller tespit edilmeye çalışılmıştır.

### Genel ÇKE Modeli SEKK Tahmin Sonuçları

Çalışmada kullanılan seriler genellikle düzeyde durağan olmayıp ancak birinci farkları alınarak durağan hale getirilmiştir. Granger ve Newbold (1974)'e göre,  $I(1)$  sürecine sahip değişkenlerle regresyon analizi yapıldığında yüksek  $R^2$  durumu ve kalıntılarda otokorelasyon sorununun olması değişkenler arasında sahte bir regresyonun olma ihtimalini güçlendirmektedir. Sahte regresyon durumunda ise SEKK tahmininden elde edilen katsayılar tutarlı olmayacak ve olağan t-istatistik değerleri yanıltıcı olacaktır. Eğer ki  $I(1)$  sürecine sahip seriler eşbütünleşikse, bu durumda SEKK modelinden elde edilen tahminler sahte olmayıp gerçeği yansıtacaktır (Gujarati ve Porter, 2018).

(1) nolu genel ÇKE modelinin altı varyasyonu SEKK Yöntemiyle tahmin edilmiş, elde edilen bulgulara göre Rusya haricindeki diğer tüm ülkeler için en uygun modellerin belirlenmesine yönelik önemli sonuçlar elde edilmiş olup tüm ülkeler için mutlak anlamda bir model seçme işlemi gerçekleşmemiştir. Ayrıca  $lnco2_{t-1}$  değişkenine ait katsayı Brezilya'ya ait genişletilmiş kübik model (4a) haricinde tahmin edilen tüm modellerde istatistiki olarak anlamlı bulunmuş olup karbondioksit emisyonuna ait cari dönem değerlerinin geçmiş dönem değerleri tarafından yönlendirildiği sonucuna ulaşılmıştır. *Yıl* değişkeninin karbondioksit emisyonu üzerindeki etkisinin anlamlılığı ise ülkelere göre değişmekte olup temel modellerde genişletilmiş modellere göre istatistiki olarak daha anlamlı bir *Yıl* değişkenine rastlanmıştır. Değişkenler arasında uzun dönemli ilişkilerin tespiti ARDL Sınır Testi ile araştırılmış ve çıkan tespitlere göre en uygun modellerin seçilme işlemleri kesinlik kazanmıştır. SEKK tahminleri sonucunda model seçim işlemleri kesinlik kazanmadığından ülkelerin karbondioksit emisyonları üzerinde önemli etki barındırdıkları düşünülen diğer açıklayıcı değişkenlere ait yorumlamalar ARDL testi sonuçlarına bırakılmıştır.

### Eşbütünleşme Test Sonuçları

E7 ülkeleri için karbondioksit-gelir ilişkisinde muhtemel tüm model spesifikasyonları arasından en uygun modellerin seçilme işleminde SEKK Tahmin Yöntemi ve ARDL Sınır Testi sonuçlarının önemli oranda birbirini destekleyici nitelikte olduğu görülmüştür. E7 ülkeleri arasında sadece Hindistan için SEKK tahmin sonuçları ile ARDL testi bulguları birbirini desteklememekte olup bu ülke için en uygun modelin seçilme işleminde ARDL testinden çıkan sonuçlar dikkate alınmıştır. SEKK tahminleri sonucunda bağımsız değişkenlerin bağımlı değişken üzerindeki kısmi etkilerinin işaretleri ve anlamlılıkları ile ARDL Sınır Testi uzun dönem tahmin sonuçları kapsamında elde edilen katsayıların işaretleri ve anlamlılıkları da önemli oranda paralellik göstermiştir.

Karbondioksit-gelir ilişkisinde ARDL Sınır Testi sonuçlarına göre ülkeler için seçilen modellerde ilişkilerin yönünün belirlenmesinde öncelikle uzun dönem katsayılarına bakılmıştır, uzun dönem katsayılarının anlamsız bulunması durumunda kısa dönem katsayıları baz alınmış fakat kısa dönem katsayılarının da anlamsız bulunduğu ülkeler için karbondioksit emisyonu-gelir arasındaki ilişki biçimi için SEKK tahmin sonuçlarından elde edilen kısmi etkilere bakılmıştır. Bu kapsamda ARDL uzun dönem sonuçlarına göre ilişki biçimi belirlenen ülkeler; Türkiye, Brezilya ve Endonezya'dır. ARDL Sınır Testi kısa dönem tahmin sonuçlarına göre ilişki biçimi belirlenen ülkeler ise Hindistan ve Meksika olmuştur. Çin için karbondioksit emisyonu-gelir ilişkisine ait en uygun model ARDL Sınır Testiyle belirlenmiş fakat gelir değişkenlerinin karbondioksit emisyonu üzerindeki kısmi etkilerinin yönlerinin belirlenmesi sürecinde SEKK tahmin sonuçları dikkate alınmıştır. Rusya için ise SEKK tahminleri sonucunda en uygun modelin belirlenme işlemi gerçekleştirilememiş olup (tüm model spesifikasyonlarının SEKK tahmin sonuçlarına göre gelir değişkenlerinin kısmi etkileri anlamsız

bulunmuştur) ARDL Sınır Testinden çıkan sonuçlar baz alınmış fakat ARDL uzun ve kısa dönem katsayılarının da anlamsız bulunmasıyla model seçimi gerçekleşse bile seçilen modeli destekleyici bulgular elde edilemediğinden karbondioksit emisyonu-gelir ilişkisinin biçimi tam bir resme kavuşturulamamıştır.

SEKK Yöntemi ve ARDL Sınır Testi bulgularının büyük oranda birbirini destekleyici istatistiki sonuçlar sunması, E7 ülkeleri için karbondioksit emisyonu-gelir ilişkisinde en uygun modelin seçilme işlemini kolaylaştırmıştır. Test sonuçlarından elde edilen bilgiler ışığında, Türkiye (genişletilmiş kübik model (4a)), Çin (genişletilmiş kuadratik model (3a)), Hindistan (genişletilmiş kübik model (4a)), Brezilya (genişletilmiş lineer model (2a)), Meksika (genişletilmiş lineer model (2a)) ve Rusya (genişletilmiş kübik model (4a)) için karbondioksit emisyonu-gelir ilişkisinde temel modeller yerine genişletilmiş modellerin seçilmesi, temel modellerde (Model 2-4) ihmal edilen değişkenlerin (fosil yakıt tüketimi, alternatif enerji tüketimi, hizmet sektörünün katma değeri, doğrudan yabancı yatırım net girişleri) karbondioksit-gelir ilişki biçimi üzerinde önemli bir etki oluşturduğunu göstermiştir. Endonezya için ise söz konusu değişkenler arasındaki ilişkiyi en iyi ifade eden modelin (Model 3) temel modeller arasından seçilmesi, bu ülke için ihmal edilen değişkenlerin karbondioksit emisyonu-gelir ilişkisinde önemli bir etki oluşturmadığı anlamına gelmektedir. Bu kapsamda karbondioksit emisyonu-gelir ilişki biçimi, Türkiye ve Hindistan için 'N', Çin için 'U' ve Rusya için ise ters 'N' şeklinde tespit edilmiştir. Brezilya ve Meksika için karbondioksit emisyonu-gelir ilişkisinde artan lineer formda bir ilişki biçiminin ortaya çıktığı görülmüş olup söz konusu değişkenler arasında ÇKE hipotezi (ters 'U' ilişkisi) sadece Endonezya için geçerli bulunmuştur.

## TARTIŞMA VE SONUÇ

Küresel ısınma ve iklim değişikliği meselelerinde tüm ulusları ortak bir amaç etrafında buluşturan Paris Anlaşması kapsamında E7 ülkelerinin niyet edilen ulusal katkı beyanlarında 2030 yılına kadar sera gazı emisyonlarını ortalama %25-60 oranında düşürmeyi taahhüt ettikleri durumu göz önünde bulundurulduğunda, ülkelere yönelik ampirik bulgular sonucunda ortaya çıkan karbondioksit emisyonu-gelir ilişki biçimlerinden hareketle Endonezya haricindeki diğer E7 ülkeleri için bu durumun görünen konjonktürde pek de olanaklı olmadığı anlaşılmaktadır.

Brundtland Raporu'nda sürdürülebilir kalkınmanın sağlanabilmesi için ekonomik büyüme ve çevre stratejilerinin birleştirilmesi gerektiği ifade edilmiş, yani ekonomik açıdan az gelişmiş ülkelerin kalkındırılması ve gelişmiş ve gelişmekte olan ülkelere ise çevresel açıdan sürdürülemez üretim ve tüketim kalıplarının ortadan kaldırılmasıyla sürdürülebilirliğin sağlanabileceği vurgulanmıştır. Gelişmiş ülkelerin sürdürülebilir kalkınma hedeflerine ulaşmalarının gelişmekte olan ülkelere göre daha olanaklı olduğu çevre-ekonomik büyüme ilişkilerini inceleyen literatür ile de sabittir (ÇKE hipotezinin geçerliliğine gelişmiş ülkelere gelişmekte ya da az gelişmiş ülkelere göre daha yüksek oranda rastlanılmıştır).

E7 ülkelerinin tarım, imalat ve sanayi sektörlerinde eski ve kirlilik yayan (yüksek oranda fosil yakıt tüketimine sebep olan) teknolojileri kullanmak yerine çevreye zarar vermeyen temiz teknolojiler geliştirmeleri ve kullanmaları, çevresel standartları koruyan yasalar koymaları ve bu yasaları mümkün mertebede uygulamaları çevresel sürdürülebilirliğin gerçekleştirilmesine katkı sağlayacaktır. Fosil yakıt tüketimi ve doğrudan yabancı yatırım net girişlerinin E7 ülkelerinin çoğu için uzun veya kısa dönemde karbondioksit emisyonu üzerinde anlamlı etki barındırmaları bu değişkenlere yönelik bir politika önerisi geliştirilmesini gerektirmiştir. Bu kapsamda, özellikle Kuzey Amerika ve Avrupa ülkelerine ait karbondioksit emisyonlarının önceki yıllara oranla düştüğü detaylı literatür taramasında da bahsedilmişti. Fakat ne yazık ki bu ülkelerin kişisel emisyon oranlarını düşürmesi ulusal ölçekte etki etse de genellikle kirlilik yoğun ekonomik faaliyetlerini geliştirmekte (Brezilya ve Meksika) veya az gelişmiş olan ülkelere sürdürdükleri için küresel bazda emisyon artırımına devam etmektedirler.

Doğrudan yabancı yatırım net girişleri kapsamında sürdürülen bu faaliyetlerde (özellikle imalat sanayinde) fosil yakıtların tüketiminden önemli oranda vazgeçilmesi, bunun yerine yenilenebilir alternatif enerji kaynaklarının kullanılması hem gelişmekte ya da az gelişmiş olan ülkelerin doğrudan yabancı yatırım gelirlerinde kesinti yaratmayacak hem de küresel ölçekte doğaya salınan sera gazı emisyonlarında düşüş gerçekleştirecektir.

#### Kaynaklar

- De Bruyn SM, Van den Bergh JCJM, Opschoor JB, 1998. Economic Growth and Emissions: Reconsidering the Empirical Basis of Environmental Kuznets Curves. *Ecological Economics*, 25: 161-175.
- Doğan B, Ghosh S, Hoang DP, Chu LK, 2022. Are Economic Complexity and Eco-innovation Mutually Exclusive to Control Energy Demand and Environmental Quality in E7 and G7 Countries? *Technology in Society*, 68: 101867.
- Granger CWJ, Newbold P, 1974. Spurious Regressions in Econometrics. *Journal of Econometrics*, 2(2): 111-120.
- Gujarati DN, Porter DC, 2018. *Temel Ekonometri*. (Çev.: Ü. Şenesen ve G. G. Şenesen). 5. Baskı, İstanbul: Literatür Yayınları.
- Kuznets S, 1955. Economic Growth and Income Inequality. *American Economic Review*, 45: 1-28.
- Kwiatkowski D, Phillips PCB, Schmidt P, Shin Y, 1992. Testing the Null Hypothesis of Stationarity Against the Alternative of a Unit Root: How Sure are We That the Economic Time Series have a Unit Root? *Journal of Econometrics*, 54: 159-178.
- Pesaran MH, Shin Y, Smith RJ, 2001. Bounds Testing Approaches to the Analysis of Level Relationships. *Journal of Applied Econometrics*, 16(3): 289-326.
- Shafik N, Bandyopadhyay S, 1992. Economic Growth and Environmental Quality: Time Series and Cross-Country Evidence. *World Development Report, Working Papers No: 904*.
- Tarı R, 2018. *Ekonometri*. Genişletilmiş 13. Baskı, Kocaeli: Umuttepe Yayınları.
- The British Petroleum Statistics. *Statistical Review of World Energy*. <https://www.bp.com/en/global/corporate/energy-economics/statistical-review-of-world-energy.html>; Erişim Tarihi: 05.02.2023.
- United Nations. *Brundtland Report*. <https://sustainabledevelopment.un.org/content/documents/5987our-common-future.pdf>; Erişim Tarihi: 12.12.2022.
- World Bank. <https://databank.worldbank.org>; Erişim Tarihi: 06.11.2022.
- World Bank. *World Development Indicators*. <https://databank.worldbank.org/source/world-development-indicators>; Erişim Tarihi: 10.05.2023.
- Zivot E, Andrews DWK, 1992. Further Evidence on the Great Crash, the Oil-Price Shock, and the Unit-Root Hypothesis. *Journal of Business & Economic Statistics*, 10(3): 251-270.



## Yaşamsal Beklenti ve Ekonomik Göstergelerin Kanonik Korelasyon Analizi ile İncelenmesi Üzerine Bir Çalışma

**Cansu Kök<sup>1\*</sup>, Muharrem Ünver<sup>1</sup>**

<sup>1</sup> Karabük Üniversitesi, Mühendislik Fakültesi, Endüstri Mühendisliği, 78100, Karabük, Türkiye

\*Sorumlu yazar e-mail: cansukokindustry@gmail.com

### Özet

*Tarihte yaşanan devrimler, teknolojik gelişmeler, vb. tarihi her olay toplumların duygu ve düşüncelerine yön vermiş ve toplumları geliştirmiştir. Toplumlar daha iyi koşullarda yaşama isteği duymuş ve gelişmeye devam etmiştir. Bu gelişimin her evresindeki daha iyi olma isteği günümüzde refah seviyesini yükseltme çabasının karşılığı olmuştur. Refah seviyesi ise toplumların ekonomik gücüyle yakından ilgili olduğundan her ülkenin toplumu için farklı refah seviyeleri oluşmuştur. Toplumların refah beklentileri bu açıdan nitel bir kavram olan mutluluk algısını oluşturmuştur. Mutluluk algısı, psikolojinin ve sosyolojinin konusu olsa da insanların ekonomik refah seviyelerinden etkilendiği için ekonomi biliminin de konusu haline gelmiştir. Bu çalışmanın amacı, mutluluk üzerinde etkili olan ekonomik değişkenler ve yaşamsal beklenti değişkenlerinin birbiri üzerindeki ilişkisini ve bu ilişkinin yönünü belirlemektir. Bu çalışmada Dünya Mutluluk Endeksine göre mutluluk algısını etkileyen değerler iki veri seti oluşturacak şekilde düzenlenmiş ve bu iki veri seti arasındaki ilişki kanonik korelasyon analizi ile incelenmiştir. Çalışma sonucunda, üç kanonik korelasyon fonksiyonu oluşmuş ancak yalnızca bir kanonik katsayı istatistiksel olarak anlamlı bulunmuştur. Ekonomik değişkenler ve yaşamsal beklenti değişkenlerinin 0,906 kanonik katsayısı ile yüksek düzeyde pozitif yönde anlamlı olduğu gözlemlenmiştir.*

**Anahtar Kelimeler:** Dünya Mutluluk Endeksi, Ekonomik Kalkınma, Kanonik Korelasyon Analizi

### GİRİŞ

Yüzyıllarca insan hayatı önemli birtakım olaylarla değişim ve gelişim göstermiştir. Son üç yüzyıl içinde yaşanan 18.yüzyıl Sanayi Devrimi, 19.yüzyıl Demografik Devrim ve 20.yüzyıl Mutluluk Devrimi insan gelişiminde etkili olan başlıca devrimlerdir. 20.yüzyıla gelindiğinde insan hayatındaki gelişime en önemli etki sosyal bilimlerdeki paradigmalarda değişimiyle belirginleşmiştir. Önceki yüzyıllarda önem arz eden yaşam beklentisi, refah ve yaşam koşulları gibi paradigmalarda, insanın memnuniyet algısıyla soyutlaşarak Mutluluk Devrimini gerektirmiştir. Mutluluk insanı ilgilendiren doğrudan bir kavram iken insan ise toplumları oluşturan temel bir varlıktır. İnsanın mutluluğu genel anlamda devletin de sürdürülebilirliği açısından önemli bir konu olmuştur. (Aksoy ve Taşkaya,2020)

Mutluluk, felsefeyle ilgili soyut bir kavramdır ancak temelde felsefenin konusu olsa da bireysel ve toplumsal bir olgudur. Mutluluk kavramı hem bireyin hem de toplumun yaşam doyumunu ve iyi hissetme halini karşılamaktadır. (Albayrak,2022) Bazen mutluluk hali insanların ulaşmak istediği nihai hedefi olarak görülmektedir. Bazı araştırmacılara göre “moral” anlamına gelirken Türk Dil Kurumu’nun belirttiği gibi mutluluk tüm isteklere tam ve devamlı ulaşılmaktan duyulan kıvanç durumudur. (Alkan ve Çilesiz,2022)

Mutluluk; ekonomi, psikoloji, sosyoloji vb. alanlarda çok kez incelenmiştir. Mutluluğun ölçülmesi ve incelenmesi için birçok parametrenin olması ve soyut bir algıdan oluşması mutluluk kavramını zorlaştırmaktadır. (Albayrak,2022) Ekonomi alanında ilk mutluluk incelemesi 1974 yılında Richard Easterlin tarafından yapılmıştır. Easterlin paradoksu ‘na göre, gelir arttıkça mutluluk artar ancak bu oran belli bir seviyeden sonra doğrusal değildir. Bu nedenle farklı fikirler de ortaya çıkmıştır. (Alkan ve Çilesiz,2022) 1970’li yıllarda Nobel ödüllü Amerikalı Kahneman, Blanch Flower, Clark, Oswald “Mutluluk Ekonomisi” teorisini geliştirmişlerdir. Gelişmekte olan ülkelerde mutluluk ekonomisi ya

ülkenin ekonomik refahının ya da bireylerin ruhsal memnuniyetinin artırılmasıyla mümkündür. Mutluluk ekonomisinde en önemli kavram; iyilik, mutluluk, esenlik anlamına gelen “subjective well-being” (SBW) kelimesidir. 1972’de Bhutan’ın çalışmalarında yer alan “Gayri safi milli mutluluk” kavramı, toplumun yaşam memnuniyet düzeyini göstererek farklı değişkenler arasındaki ilişkiyi incelemektedir. Sadece parasal değerleri değil sürdürülebilir kalkınma için vatandaşların mutluluğunu artıracak koşulları da geliştirmeyi amaçlamıştır. (Albayrak,2022) 1970’lerden sonra yapılan çalışmalarda yaşam memnuniyetinin sağlanması için ekonomik gelişmelerin yanı sıra insan merkezli çalışmaların yapılması savunulmuştur. (Türkmen ve Tıraş,2020)

Son zamanlarda toplum mutluluğunun sürdürülebilirliği için devletin, politikacıların ve piyasa ekonomistlerinin mutluluk üzerine çalışmalarında ekonomi, ulaşım, sağlık, çevre ve güvenlik alanlarına önem vermesi öngörülmektedir. (Aksoy ve Taşkaya,2020). Aynı zamanda davranışsal iktisat çalışmaları mutluluğun ekonomi ilişkisini incelemiştir ancak mutluluk ekonomisi refah seviyesini de inceleyerek farklı bir bakış açısı sağlamıştır. Bu bağlamda refah düzeyinin iyi olması ekonomiyi de iyileştirmiştir. Refah düzeyi ve mutluluk kavramlarının iyileşmesiye ekonomik kalkınmada olumlu anlamda etkilenecektir. (Albayrak,2022)

Bu çalışmanın amacı; ekonomik değişkenler ile yaşamsal beklenti değişkenleri arasındaki ilişkinin kanonik korelasyon analiz yöntemiyle incelenmesi ve bu ilişki içinde hangi değişkenlerin ilişkinin yönünü belirlediğinin tespit edilmesidir.

Bu çalışmada Birleşmiş Milletler Kalkınma Ağı’nın yayınladığı 2022 dünya mutluluk raporunda yer alan 104 ülkeye ait veriler ile çalışılmıştır. Bu verilerden ekonomi ve yaşamsal beklenti ile ilgili değişkenleri içeren iki farklı veri seti oluşturulmuştur. Çalışmada oluşturulan veri setleri kanonik korelasyon analizi ile incelenmiştir. Mutluluğa etki eden bu değişkenler arasındaki ilişkinin anlamlı pozitif yönde olduğu ortaya koyulmuştur. Kanonik korelasyon modeline göre ekonomi ve yaşamsal beklenti değişkenleri arasındaki bu ilişkinin oluşmasına en çok katkıyı sağlayan ekonomik veri setindeki günlük kişi başına milli GSYİH değişkeni ile yaşamsal beklenti veri setinde doğumda sağlıklı yaşam beklentisi olmuştur. Buna göre ekonomi alandaki iyileştirmeler sağlıklı yaşam beklentisini de artıracaktır.

#### *Literatür Taraması*

Mutluluk üzerine genel literatür incelendiğinde ekonomi ve insana yönelik çalışmalar olduğu tespit edilmiştir. Bu bağlamda konu daha detaylandırıldığında ekonomi ve insan refahını konu alan Mutluluk Ekonomisi, gelir eşitsizliğinde insanın mutluluğu, ekonomik kalkınma ve insani gelişmişlik konu başlıkları üzerine birçok dikkat çekici çalışma yapıldığı görülmüştür. Çalışmaların bir kısmı istatistiksel ve ekonometrik analizler ile bir kısmı ise ampirik ve teorik olarak bu ilişkiyi incelemiştir. Mutluluk ekonomisi üzerine çalışan araştırmacılardan bazıları Dünya Mutluluk Raporu indekslerinden yararlanmıştır. Ekonomik kalkınma ve insani gelişme ilişkisini inceleyen araştırmacılar ise OECD ülkelerini örneklem olarak insani gelişmişlik indeksini kullanmıştır. Literatürde ekonomik göstergeler ve yaşamsal beklenti arasındaki ilişkinin incelendiği çalışmalar vardır.

Efeoğlu ve Azgün(2021), çalışmasında demokrasi ile yönetilmenin bir ekonomik kalkınma göstergesi olduğunu ve bu yönetim biçiminin ülkelerin mutluluk düzeylerine olan ilişkisini panel veri analizi ile incelemiştir. Nitel bir kavram olan mutluluğu ekonomik kalkınmayla ilişkilendirilerek BRIC ve MIST ülkeleri olarak bilinen 8 ülkenin 2013-2018 verilerini panel veri analizi metoduyla araştırılmıştır. Araştırma sonucunda ise demokrasinin ülke mutluluk düzeyini etkilediği görülmüştür. Güzel (2017), ülkelerin refah seviyeleri ve mutluluk indekslerinin gelir eşitliğiyle arttığını ve gelir eşitsizliği az olan ülkelerde refah seviyesinin ve mutluluk indeksinin daha yüksek olması üzerine çalışmıştır. Sürdürülebilir Kalkınmanın şartının gelir dağılımındaki eşitlik olduğunu ve refah seviyesinin bu şekilde yükseltilebileceğini savunmuştur. OECD ülkelerine ait Gini katsayısı ve mutluluk indeksleri ile çalışarak gelir dağılımında eşitliğin önemini ortaya koyarak çalışması sonlandırmıştır. Dağdeviren



ve Yıldız (2017), ekonomik kalkınmanın sadece ekonomik alanda değil sosyal, kültürel vb. birçok alandaki yapısal değişimi üzerinde durmuştur. Bhutan Krallığı örneğini, Gayrisafi milli mutluluk kriterlerinden psikoloji, sağlık, eğitim, esneklik, kültürel ve ekolojik değerlerini alarak çalışmıştır. Çalışmasında birçok alandaki bu değişikliği mutluluk ekonomisi ile ilişkilendirerek Gayrisafi milli mutluluğun mutluluk ekonomisinde çok önemli yeri olduğu sonucuna ulaşmıştır. Aydınbaş ve Erdiç (2022), teknoloji ile gelişen toplumları Toplum5.0 bağlamında değerlendirerek mutluluk sağlayan iyi koşullar, çevre, sağlık vb. faktörleri panel veri analizi ile incelemiştir. Mutluluk indeksini bağımlı değişken olarak almış ve diğer etkenleri bağımsız değişken olarak ele almıştır. 8 OECD ülkesi için yaptığı çalışmada kişi başına GSYH ile mutluluk arasında ve yenilebilir enerji tüketimi ile mutluluk arasında pozitif yönlü anlamlı bir ilişki bulmuştur. Araştırmadaki diğer bağımsız değişkenler mutluluk endeksini %89 oranında açıklamıştır. Nurdoğan (2021), otuz yedi OECD ülkesine ait teknoloji ve işgücü piyasası veri seti oluşturarak bu verileri kanonik korelasyon analizi ile incelemiştir. Çalışmasında SPSS 25 analiz programını kullanılmıştır. Çalışmanın amacı teknoloji ve işgücü piyasasına etki eden değişkenlerin tespit edilmesidir. Çalışmada dört kanonik fonksiyona rastlanmış ve birinci kanonik fonksiyonun anlamlı olduğunu tespit etmiştir. Çalışma sonunda 0,855 oranında anlamlı ve pozitif yönde yüksek bir ilişki görülmüştür. Menevşeoğlu (2019), OECD ülkelerinin gelişmişliğine göre sağlık risk faktörleri ve refah göstergeleri arasındaki ilişkinin yönü kanonik korelasyon analiziyle incelemiştir. Çalışmanın sonucunda iki değişken seti arasında anlamlı bir ilişki tespit etmiştir. Albayrak (2022), Mutluluk Ekonomisi ve Türkiye adlı makale çalışmasında ekonomi ve mutluluk kavramlarıyla ilişkili olan araştırmaları tablo ve grafiklerle detaylı olarak inceleyerek TÜİK'in açıkladığı mutluluk araştırmaları ve makroekonomiyi Türkiye açısından ele almıştır. Mutluluğun birçok alanla bütünleşik olduğunu ve doğrudan ekonominin bir konusu olduğunu savunmuştur. Türkmen ve Tıraş (2020), çalışmasında insani gelişmenin milli gelirde kapsadığını ve insanın ekonomisinden çok insan hayatının zenginleşmesi gerektiğini savunmuştur. Çalışmasında BRICS-T (Brezilya, Rusya, Hindistan, Çin, Güney Afrika Cumhuriyeti ve Türkiye) ülkelerinin insani gelişme ve kentleşme ile ekonomik büyüme verilerine ilişkin panel veri analizi yapmıştır. Çalışma sonucunda ise insani gelişme endeksinin %1 artışı milli geliri %8,8 lik arttırmıştır. Bu nedenle insani gelişim endeksini yükseltmek ekonomik büyümeyi de yükselteceği için bu alanda yatırımların yapılmasını önermiştir. Kaya (2020), Wall Street Journal, Heritage Vakfı'nın yayınladığı "Ekonomik Özgürlük Endeksi" ile Dünya Mutluluk Raporu'ndaki mutluluk endekslerini karşılaştırarak ekonomi ve mutluluk arasındaki ilişkinin yönünü ve botunu kümeleme analizi ile incelemiştir. Çalışma sonucunda Ekonomik Özgürlük Endeksi ve Mutluluk Endeksi yüksek olanların bir grupta düşük olanların ise bir grupta kümelendiği tespit edilmiştir. Aksoy ve Taşkaya (2020), Dünya Mutluluk Raporunda yer alan makroekonomik değişkenler ile mutluluk düzeyleri arasındaki ilişkiyi regresyon analizi ile incelemiştir. Yöntem kısmında Eviews programı kullandığı bu çalışmada kişi başına düşen gayrisafi milli hasılanın mutluluk düzeyi ile pozitif anlamlı ve işsizlik ve enflasyon oranlarının ise negatif anlamlı ilişki oluşturduğunu tespit etmiştir. Ayrıca hükümet harcamaları ve ekonomik büyümenin mutluluk düzeyini anlamlı derece etkilemediği görülmüştür. Araştırmanın sonucu ise makroekonomik belirleyicilerin ortaya konması için politikacılara fayda sunmuştur. Kandemir (2021), sosyal eşitsizliklerin mutluluk düzeyine etkisini incelediği araştırmasında 2019 dünya mutluluk raporunda yer alan 104 ülke için mutluluk indekslerini bağımlı değişken; eğitim, sağlıklı yaşam beklentisini ve gelir eşitsizliklerini (%) bağımsız değişken olarak ele almıştır. Yaptığı lojistik regresyon analizi ile eğitim ve sağlık alanlarındaki eşitsizliklerin mutsuzluğa neden olduğu bu alanlara eşit fırsatlar verilmesi gerektiği sonucuna varmıştır. Ari (2019), sürdürülebilir ekonomik kalkınma için yalnızca gelir eşitliğinin yeterli olmadığını mutluluk ekonomisi kavramı ile insanların sosyal anlamdaki iyileştirmeleri de beklediğini Bhutan'ın Sürdürülebilir Kalkınma ile incelemiştir. Bhutan'ın Sürdürülebilir Kalkınma modeli ile gayrisafi milli mutluluğun ortaya çıktığını belirtmiştir. Çalışmada Bhutan'ın Sürdürülebilir Kalkınma modeline katkı sağlayacak bir ortak bir anlayış tartışılmıştır. Servet (2018), Birleşmiş Milletler Kalkınma Ağı'nın yayınladığı dünya mutluluk



endeksinin yer aldığı ve bu endeksi etkileyen 9 faktörü arasındaki olumlu ve olumsuz etkiyi logit sıralı model incelemiştir. Bu değişkenlerden mutluluk üzerine olumlu etki yapanların kişi başına GSYİH, sosyal destek, sağlıklı yaşam beklentisi, seçim özgürlüğü ve pozitif etki olduğunu olumsuz etki yapanların ise yolsuzluk algısı, hükümete güven, işsizlik ve enflasyon oranları olduğunu tespit etmiştir. Alkan ve Çilesiz (2022), mutluluğu etkileyen 10 değişkeni G7 ülkeleri ve Türkiye açısından VIKOR yöntemiyle incelemiş ve en yüksek mutluluk düzeyine sahip ülkenin İngiltere ve en düşük mutluluk düzeyine sahip ülkenin Türkiye olduğunu bu farkın ise sosyo-ekonomik faktörlerle ilgili olduğunu tespit etmiştir.

Literatürde insan mutluluğuna etki eden faktörlerin incelendiği ve nedensel ilişki analizlerinin yapıldığı, tespit edilen sonuçlara göre mutluluğun makro ekonomi ve sosyo-ekonomik faktörlerle yakından ilgili olduğu görülmüştür. Literatür incelemelerinde ekonomi ve mutluluk ilişkisi birçok analiz yöntemiyle incelenmiş ve sonuçlar ekonominin iyileşmesinin mutluluk üzerine olumlu etki yaptığı yönündedir. Bazı araştırmacılara göre ise mutluluk ve refah seviyesinin yüksek olması ekonomik kalkınma için önemli olmuştur. Bu çalışmada ekonomi ve yaşamsal beklenti arasındaki ilişkinin kanonik korelasyon ile incelenmesi literatüre katkı sağlayacaktır.

## MATERYAL VE METOD

Çalışma, ekonomik gösterge değişkenleri ile yaşamsal beklenti değişkenleri arasındaki ilişkiyi kanonik korelasyon analizi ile araştırmayı ve bu ilişkiyi en çok etkileyen değişkenleri belirlemeyi amaçlamıştır. Çalışmanın bu bölümünde veri setine ait detaylı bilgiler, araştırma konusunda yer alan değişkenler için kurulan model, hipotez ve uygulanan istatistiksel analiz yöntemleri belirtilmiştir.

### *Verilerin Toplanması*

Çalışma verileri, 2022 Dünya Mutluluk Raporu'ndan elde edilmiştir, veri kaynağı ise kaggle/datasets/world-happiness-report-2022 'dir. Dünya Mutluluk Raporundaki ülkelerden veri kaybı görülenler veri setinde elimine edilmiş ve 104 ülke araştırmaya dâhil edilmiştir. Çalışmanın uygulama aşamasındaki analiz için SPSS 27 paket programı kullanılmıştır.

Çalışmanın amacına yönelik Kanonik korelasyon analizin uygulanabilmesi için normal dağılıma sahip iki bağımsız veri seti oluşturulmuştur. Dünya Mutluluk Raporu verileri X veri seti, ekonomik gösterge verilerini; Y veri seti, yaşamsal beklenti verilerini içerecek şekilde düzenlenmiştir. Ekonomik gösterge veri setinde ülkenin ekonomik durumu ve insanların ekonomik algısıyla ilgi veriler yer almaktadır. Yaşamsal beklenti veri seti ise ülkedeki insanların sahip olduğu özgürlükler, sosyal çevresi ve sağlık hizmetleriyle ilgilidir.

Araştırmanın değişkenleri aşağıdaki gibi belirlenmiştir:

X1= Günlük Kişi Başına GSYİH

X2= Bireysel Cömertlik Algısı

X3= Yolsuzluk Algısı

Y1=Doğumdan Sağlıklı Yaşam Beklentisi

Y2= Yaşam Seçimleri Yapabilme Özgürlüğü

Y3=Sosyal Manevi Destek Görme

Tablo-1' de bu çalışmada yer alan ekonomi veri seti X1, X2, X3 ve yaşamsal beklenti veri setine ait değişkenler Y1, Y2, Y3 için detaylı açıklamalar verilmiştir.

**V. INTERNATIONAL APPLIED STATISTICS CONGRESS (UYİK - 2024)**  
**İstanbul / Türkiye, May 21-23, 2024**

**Tablo 1.** Çalışmanın Veri Setinde Yer Alan Değişkenler

Ekonomik Göstergeler	X1	Günlük Kişi Başına GSYİH	Dünya Bankası tarafından WDI'den alınan, sabit 2017 uluslararası dolarına ayarlanmış Satın Alma Gücü Paritesi cinsindedir.
	X2	Cömertlik	İnsanların kişi başına günlük GSYİH üzerinden bağış yapma gücüdür.
	X3	Yolsuzluk Algısı	Devletin yolsuzluk yapıp yapmadığına dair sorulan 0-1'den oluşan ikili yanıtlarının ortalamasıdır.
Yaşamsal beklenti Göstergeleri	Y1	Doğumda Sağlıklı Yaşam Beklentisi	Doğumda Sağlıklı yaşam beklentisi veri seti WHO Küresel Sağlık Gözleminde edilen bilgiler ışığında oluşturulmuştur.
	Y2	Yaşam Seçimleri Yapma Özgürlüğü	Kişinin hayatıyla ilgili seçim yapma, karar verme, mevcut fikir özgürlüğünden memnun olup olmamasına ilişkin 0-1'den oluşan ikili yanıtlarının ortalamasıdır.
	Y3	Sosyal Destek	Kişinin ihtiyaç duyduğu anda manevi destek olacak birinin olup olmasına ilişkin sorulan 0-1'den oluşan ikili yanıtlarının ortalamasıdır.

Bu çalışmada oluşturulan değişkenlere göre 104 ülkeye ait 2022 verileri kullanılarak veri seti oluşturulan veri setinin bir kısmı Tablo-2'deki gibi verilmiştir.

**Tablo 2.** Çalışmada Kullanılan Veri Seti

Değişkenler	Ekonomik Göstergeler			Yaşamsal Beklenti Göstergeleri		
	Günlük Kişi Başına GSYİH	Cömertlik	Yolsuzluk Algısı	Doğumda Sağlıklı Yaşam Beklentisi	Yaşam Seçimleri Yapma Özgürlüğü	Sosyal Destek
Arnavutluk	9,626482964	-0,065987259	0,845501959	69,17500305	0,802249789	0,724089622
Arjantin	10,01140499	-0,127506226	0,810037434	67,25	0,825188935	0,893329561
Ermenistan	9,667765617	-0,154325441	0,704730451	67,92500305	0,789598525	0,811169267
Avustralya	10,85352898	0,15346466	0,545216978	71,125	0,853776991	0,941673338
Avusturya	10,93891716	0,139042094	0,524212122	71,27500153	0,855502605	0,876287401
Bangladeş	8,743256569	-0,054776076	0,61687237	64,67500305	0,86457628	0,403707534
Belçika	10,87826824	0,096943997	0,48338443	71,05000305	0,889889002	0,922732711
Benin	8,136793137	-0,029674673	0,579618931	56,40000153	0,714036763	0,365682811
Bolivya	9,014473915	-0,080244467	0,84024471	63,75	0,86501044	0,823510289
Botsvana	9,629345894	-0,21462056	0,830940306	54,72499847	0,739403069	0,750399292
Brezilya	9,610548019	-0,060690548	0,741963506	65,92500305	0,82977134	0,865809739
Bulgaristan	10,13758183	-0,145212695	0,941625774	66,59999847	0,741359413	0,952761054
Kamboçya	8,414617538	0,154094294	0,859684169	62,09999847	0,946244061	0,78360188
Kamerun	8,227441788	0,025319204	0,849325359	56,52500153	0,674506366	0,629108608
Kanada	10,80336666	0,221541926	0,44200018	71,44999695	0,838263929	0,929101527
Çad	7,261128902	0,221161678	0,805424452	53,125	0,679479539	0,719671786
Acı biber	10,15356255	-0,010977617	0,796396375	70,44999695	0,793485582	0,886761963
Kolombiya	9,659547806	-0,161807224	0,862641215	69,52500153	0,799183786	0,87694943
Komorlar	8,074591637	-0,014281231	0,732310832	59,42499924	0,480553567	0,471820921
Kongo	8,077151299	0,027624207	0,759754062	57,17499924	0,69769448	0,646345079
...	...	...	...	...	...	...
Zimbabve	7,670122623	-0,069513284	0,752632082	54,52500153	0,651987135	0,666171908

Tablo 2' deki veriler Dünya Mutluluk Raporu'dan elde edilmiş değişkenlere aittir. **Tablo 2.**devam etti.  
*Hipotez*

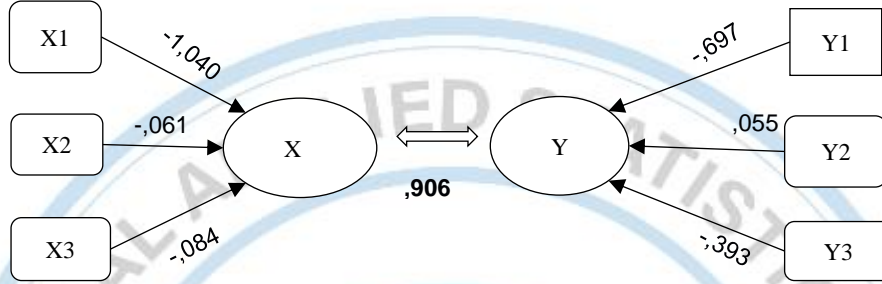
Çalışmaya ilişkin kurulan hipotez deteyaları aşağıdaki gibidir;

$H_0$ = Ekonomik göstergeler ve Yaşamsal beklenti Göstergeleri arasında anlamlı bir fark yoktur.

$H_1$ = Ekonomik göstergeler ve Yaşamsal beklenti Göstergeleri arasında anlamlı bir fark vardır.

Yukarıda kurulan  $H_0$  hipotezi Ekonomik göstergeler ile Yaşamsal beklenti göstergeleri arasında anlamlı ve önemli bir fark çıkmadığını,  $H_1$  hipotezi ise insanın mutluluk düzeyine etki eden değişkenlerin arasında anlamlı ve önemli bir fark olduğunu ifade etmektedir.

Bu çalışmadaki bağımsız ekonomi seti olarak belirlenen  $X_1, X_2, X_3$  ve bağımsız yaşamsal beklenti seti olarak belirlenen  $Y_1, Y_2, Y_3$  ilişkisindeki analiz için kurulan açıklayıcı şema Şekil-1'deki gibidir.



Şekil 1. Çalışmada Kurulan Açıklayıcı Şema ve Kanonik Katsayılar

#### İstatistiksel Analiz

Çalışmada, Dünya Mutluluk Raporu'nda mutluluk indeksi verilen yüz dört ülkeye ait ekonomi ve yaşamsal beklenti veri setleri kullanılmıştır. Ekonomi setine ait değişkenler hem insanların bireysel ekonomisine hem de ülkesine ait ekonomik algıları içermektedir. Yaşamsal beklenti veri setine ait değişkenler ise insanın yaşamını doğrudan etkileyen değişkenler seçilerek oluşturulmuştur. Çalışmada yer alan ekonomi ve yaşamsal beklenti değişkenlerini içeren ilişkinin analizi, çok değişkenli istatistiksel analiz tekniklerinden biri olan kanonik korelasyon analizi ile gerçekleştirilmiştir. Bu analiz yöntemi 1936'da iki değişken arasındaki ilişkinin yönünün ve kuvvetinin açıklanması için Hotelling tarafından geliştirilmiştir. (Nurdoğan,2021)

Korelasyon Analizi istatistiksel olarak en basit haliyle incelenen rasgele iki değişken arasındaki korelasyonu ifade eder. Bu değişkenler çoklu boyutlu bir ana kütlede bağımlı ve bağımsız olma durumunda kanonik korelasyon ile incelenmektedir. (Menevşeoğlu,2019)

Çalışmada çok değişkenli bir istatistiksel analiz metodu olarak kullanılan kanonik korelasyon analizinin temel denklemleri ve açıklamaları aşağıdaki gibidir. İki farklı veri seti ve veri setlerine ait birden fazla değişken mevcuttur. (Nurdoğan,2021)

$$\begin{aligned} U_1 &= a_{11}X_1 + a_{12}X_2 + \dots + a_{1q}X_q \\ V_1 &= b_{11}Y_1 + b_{12}Y_2 + \dots + b_{1p}Y_p \end{aligned} \quad (1)$$

Yukarıdaki birinci denklem incelendiğinde ( $U_1, V_1$ ) birinci kanonik değişken olduğu görülür. Bu kanonik değişkenlerin korelasyonu ise  $\rho_1$  ile gösterilmektedir.  $\rho_1$  değeri, birinci kanonik korelasyon olarak ifade edilir. (Nurdoğan,2021)

$$\rho_{v,v} = \frac{Kov(U, V)}{\sqrt{Var(U)Var(V)}} = \frac{a' \Sigma_{12} b}{\sqrt{(a' \Sigma_{11} a)(b' \Sigma_{22} b)}} \quad (2)$$

Yukarıdaki ikinci denklemde kanonik korelasyonu ( $\rho_{u,v}$ ) değerleri olarak veren denklemin detayları verilmiştir.

Aşağıdaki üçüncü denklem ile kanonik korelasyon katsayılarının anlamlılığını test edebilmek için oluşturulan iki hipotez aşağıdaki gibi verilmiştir. (Nurdoğan,2021)

$$H_0 = p_1 = p_2 = \dots = p_n = 0 \quad (3)$$



$$H1 \neq p1 \neq p2 \neq \dots \neq pn \neq 0$$

Kanonik yüklerinin basit korelasyon katsayısını gösterdiği bilindiğinde ( $U1, V1 \dots Un, Vn$ ) kanonik değişkenleri ile kanonik korelasyon katsayısını en çok etkileyen orjinal kanonik değişkenlerinin belirlenmesini sağladığı açıklanabilir. (Nurdoğan,2021) (4)

$$P_{(U_i, X_i)} = \frac{Kov(U_i, X_i)}{\sqrt{[K\ddot{o}\ddot{s}}(Var(U_i))][K\ddot{o}\ddot{s}}(Var(X_i))]} = \frac{a' \Sigma_{11}}{\sqrt{[K\ddot{o}\ddot{s}}(\Sigma_{11})]}$$

Dördüncü denklemde  $U_i$  kanonik değişkeninin kendi veri setindeki ( $X$ ) orjinal değişkenleri arasındaki ilişkisinin denklemine yer verilmiştir.

Kanonik çapraz yük, orjinal bağımlı değişkenlerle, bağımsız kanonik değişkenler veya orjinal bağımsız değişkenlerle, bağımlı kanonik değişkenler arasındaki basit doğrusal katsayılarıdır.  $U_i$  kanonik değişkeninin karşı veri setindeki ( $Y$ ) orjinal değişkenleri arasındaki ilişki beşinci denklemdeki gibi hesaplanır. (Nurdoğan,2021)

(5)

$$P_{(U_i, Y_i)} = \frac{a' \Sigma_{12}}{\sqrt{[K\ddot{o}\ddot{s}}(\Sigma_{22})]}$$

$V_i$  kanonik değişkeninin kendi veri setindeki ( $Y$ ) orjinal değişkenleri arasındaki ilişkiyi gösteren denklem aşağıdaki gibidir; (Nurdoğan,2021) (6)

$$P_{(V_i, Y_i)} = \frac{b' \Sigma_{21}}{\sqrt{[K\ddot{o}\ddot{s}}(\Sigma_{22})]}$$

$V_i$  kanonik değişkeninin karşı veri setindeki ( $X$ ) orjinal değişkenleri arasındaki ilişkiyi gösteren denklem aşağıdaki gibidir; (Nurdoğan,2021) (7)

$$P_{(V_i, X_i)} = \frac{b' \Sigma_{11}}{\sqrt{[K\ddot{o}\ddot{s}}(\Sigma_{12})]}$$

Bağımlı ya da bağımsız değişken setlerinden herhangi birinin diğer sete ait açıkladığı toplam varyansa Toplam Gereksizlik İndeksi denir ve TRI olarak ifade edilir, aşağıdaki gibi hesaplanmaktadır. (8)

$$TRI_{Y/X} = \sum_{i=1}^m RI_{U_i/V_i} = \sum_{i=1}^p \frac{R_{y_i}^2}{p}$$

## BULGULAR

Çalışmanın uygulamadaki kanonik korelasyon sonucu incelendiğinde üç kanonik korelasyon katsayısı ve üç kanonik korelasyon fonksiyon elde edilmiştir. Elde edilen kanonik katsayıların ve fonksiyonların anlamlılığına ait Wilk's Lamda test sonucu Tablo-3'de verilmiştir.

**Tablo 3.** Kanonik korelasyon katsayı ve anlamlılık testler

U1,V1	Kanonik Korelasyon	Özdeğer	Wilks' Lamda	F	Pay Serbest D.	Payda Serbest D.
1	,906	4,573	,146	31,639	9,000	236,223
2	,376	,164	,813	5,340	4,000	196,000
3	,231	,056	,947	5,582	1,000	99,000

Tablo-3'de Wilk's Lamda anlamlılık testi sonuçları verilmiştir.  $H_0$  hipotezinde tüm kanonik korelasyon katsayılarının sıfıra eşit olması,  $H_1$  hipotezinde en az bir katsayının sıfırdan farklı olarak sonuçlanması beklenmektedir. Elde edilen üç kanonik korelasyon katsayısı Wilk's Lamda anlamlılık testine göre incelendiğinde birinci ve ikinci kanonik katsayısı anlamlıdır. Özdeğer için 4,573 ile en yüksek değer ve Wilks Lamda değeri 0,146 ile 0,05 'e en yakın değer olduğu için birinci kanonik katsayısının daha anlamlı olduğu görülmüştür. Bu nedenle çalışma birinci kanonik katsayısı ve

fonksiyonu alınarak devam etmiştir. [Wilks's Lambda= .146, F(9, 236.223)= 31,639, p<.05] H0 hipotezi reddedilerek H1 hipotezi kabul edilmiştir.

Birinci kanonik korelasyon katsayısına bakıldığında. 906 değeri ile ekonomi göstergeleri ile yaşamsal beklenti veri setleri arasında yüksek derecede bir ilişki olduğunu görülmektedir. Birinci kanonik katsayısına göre değerler %90,6 oranında birbirini açıklamaktadır. Birinci kanonik korelasyonun açıkladığı varyansı ifade eden kanonik özdeğer ise 4,573 olarak çıkmıştır, bu oran ekonomi ve yaşamsal beklenti veri setlerinin çok yüksek oranda varyans paylaştıklarını ifade etmektedir.

Çalışmada kullanılan ekonomi ve yaşamsal beklenti değişkenlerine ait tüm değişkenler için oluşan basit doğrusal korelasyon hesaplamaları Tablo- 4'deki gibidir.

**Tablo 4.** Veri Setindeki Değişkenlerin Kanonik Katsayıları

Değişkenler	X1	X2	X3	Y1	Y2	Y3
X1	1	-0,093	-0,448	0,88	0,381	0,792
X2		1	-0,261	-0,075	0,213	0,028
X3			1	-0,396	-0,401	-0,27
Y1				1	0,396	0,747
Y2					1	0,493
Y3						1

Tablo-4'de Veri Setindeki Değişkenlerin Kanonik Katsayıları tablosunda ekonomi veri seti ve yaşamsal beklenti veri setine ait değişkenlerin kendi içindeki korelasyon ilişkileri verilmiştir. Tablodan çıkarılacak sonuçlar aşağıdaki gibidir;

X1- X2 değişkenleri için negatif yönde anlamlı düşük düzeyli ilişkinin olduğu görülmüştür.

$$(r = -.093, p < 0.05).$$

X2- X3 değişkenleri için negatif yönde anlamlı düşük düzeyli ilişkinin olduğu görülmüştür.

$$(r = -.261, p < 0.05).$$

Y1- Y2 değişkenleri için pozitif yönde anlamlı ve orta düzeyli ilişkinin olduğu görülmüştür.

$$(r = -.396, p < 0.05).$$

Y1- Y3 değişkenleri için pozitif yönde anlamlı ve yüksek düzeyli ilişkinin olduğu görülmüştür.

$$(r = .747, p < 0.05).$$

Y2- Y3 değişkenleri için pozitif yönde anlamlı ve orta düzeyli ilişkinin olduğu görülmüştür.

$$(r = .493, p < 0.05).$$

X1 -Y1 değişkenleri için pozitif yönde anlamlı yüksek düzeyli ilişkinin olduğu görülmüştür.

$$(r = .88, p < 0.05).$$

X1-Y2 değişkenleri için pozitif yönde anlamlı orta düzeyli ilişkinin olduğu görülmüştür.

$$(r = .381, p < 0.05).$$

X1- Y3 değişkenleri için pozitif yönde anlamlı yüksek düzeyli ilişkinin olduğu görülmüştür.

$$(r = .792, p < 0.05).$$

X2-Y1 değişkenleri arasında negatif yönlü anlamlı düşük düzeyli ilişkinin olduğu görülmüştür.

$$(r = -.075, p < 0.05).$$

X2 -Y2 değişkenleri için pozitif yönde anlamlı düşük düzeyli ilişkinin olduğu görülmüştür.

$$(r = .213, p < 0.05).$$

X2 -Y3 değişkenleri için pozitif yönde anlamlı düşük düzeyli ilişkinin olduğu görülmüştür.

$$(r = .028, p < 0.05).$$

X3- Y2 değişkenleri için negatif yönde anlamlı düşük düzeyli ilişkinin olduğu görülmüştür.

$$(r = -.27, p < 0.05).$$

Tablo-5'te verilen kanonik değişkenler için standartlaştırılmış kanonik katsayıları değişken setlerinde yer alarak değişken setindeki kanonik değişkenin oluşmasındaki katkıyı sağlamaktadır.

**Tablo 5.** Kanonik Değişken Çiftleri için Standartlaştırılmış Kanonik Katsayılar

	U1	U2	U3		V1	V2	V3
X1	-1,04	0,4	0,296	Y1	-0,697	-0,339	-1,292
X2	-0,061	-0,185	1,05	Y2	0,055	-1,103	0,324
X3	-0,084	1,031	0,587	Y3	-0,393	0,886	1,26

Tablo 5'te belirtilen standartlaştırılmış kanonik korelasyon katsayıları orijinal değişkenlerin kanonik korelasyona yaptığı etkiyi ifade etmektedir. 1'deki Wilk Lamda anlamlılık test sonucu kontrol edildiğinde, birinci kanonik değişkene ait korelasyon katsayısının anlamlı olarak bulunmuştur. Bu nedenle birinci kanonik korelasyonuna göre Tablo 5'te elde edilen kanonik değişken çiftlerine ait standartlaştırılmış kanonik katsayılarıyla U ve V için üç farklı doğrusal fonksiyon oluşturulmuştur. Birinci kanonik korelasyonun oluşmasına etki eden kanonik katsayılar kullanılarak en yüksek ilişkinin bulunması için birinci kanonik değişken çiftine (U1 ve V1) ait doğrusal fonksiyonlar aşağıdaki gibi oluşturulmuştur.

$$U1 = -1,04 X1 - 0,061 X2 - 0,084 X3$$

$$V1 = -697 Y1 + 0,055 Y2 + -0,393 Y3$$

Anlamlı bulunan birinci kanonik değişken çiftine (U1V1) en çok etki eden değişkenler X1: Kişi Başına Düşen Günlük GSYİH ve Y1: Doğumda Sağlıklı Yaşam Beklentisi değişkenleridir.

Ekonomi veri seti içinde birinci kanonik fonksiyonun katsayısını en çok hangi değişkenin etkilediği ve yaşamsal beklenti değer göstergelerinden hangi değişken ile en güçlü ilişkinin kurulduğu bilgisi Tablo 6'da yer almaktadır.

**Tablo 6.** Ekonomi Veri Setine Ait Kanonik Yük ve Kanonik Çapraz Yükler

Set1	U1	U2	U3	V1	V2	V3
X1	-0,997	-0,045	-0,065	-0,903	-0,02	-0,015
X2	0,059	-0,491	0,869	0,053	-0,18	0,201
X3	0,397	0,9	0,181	0,36	0,338	0,042

Tablo-6'da kanonik yükler ve kanonik çapraz yükler incelendiğinde; Ekonomi veri setinin kanonik katsayısını en çok etkileyen -0,997 kanonik katsayısı ile X1: kişi başına günlük GSYİH dir. Aynı zamanda çapraz kanonik yükler incelendiğinde; Ekonomi veri seti içinde yaşamsal beklenti kanonik katsayısını en çok etkileyen yine-0,903 X1: kişi başına günlük GSYİH değişkenidir.

Yaşamsal beklenti içinde birinci kanonik fonksiyonun katsayısını en çok hangi değişkenin etkilediği ve ekonomi göstergelerinden hangi değişken ile en güçlü ilişkinin kurulduğu bilgisi Tablo 7'de verilmiştir.

**Tablo 7.** Yaşamsal beklenti Veri Setine Ait Kanonik Yük ve Kanonik Çapraz Yükler

Set2	U1	U2	U3	V1	V2	V3
Y1	-0,968	-0,114	-0,222	-0,877	-0,04	-0,051
Y2	-0,414	-0,8	0,434	-0,375	-0,3	0,1
Y3	-0,886	0,089	0,455	-0,803	0,034	0,105

Tablo-7'de kanonik yükler ve kanonik çapraz yükler incelendiğinde; yaşamsal beklenti veri setinin kanonik katsayısını en çok etkileyen -0,968 kanonik katsayısı ile Y1: Doğumda Sağlıklı Yaşam Beklentisi' dir. Aynı zamanda çapraz kanonik yükler incelendiğinde; yaşamsal beklenti veri seti içinde Ekonomi kanonik katsayısını en çok etkileyen ise -0,877 oranı ile Y1: Doğumda Sağlıklı Yaşam Beklentisi değişkenidir.

Kanonik korelasyon analiz sonucunda birinci kanonik fonksiyonuna ait değişkenlerin veri setleri içindeki açıklanma oranları Tablo 8' de verilmiştir.



**Tablo 8.** Açıklanan Varyans Oranları ve Gereksizlik İndeksleri

Kanonik Değişken	Ekonomi Veri Seti		Yaşamsal Beklenti Veri Seti	
	Kendi Kanonik Değişkeni Tarafından	Karşıt Kanonik Değişkeni Tarafından	Kendi Kanonik Değişkeni Tarafından	Karşıt Kanonik Değişkeni Tarafından
<b>1</b>	0,385	0,316	0,632	0,518

Tablo 8'deki değerler hem kendi veri setindeki kanonik değişken tarafından hem de diğer veri setindeki kanonik değişken tarafından açıklanma oranlarını ifade etmektedir.

U1 birinci kanonik değişkenin ekonomi veri seti içindeki değişkenler tarafından açıklanma gücü ve açıklanan varyans oranı %38,5;

V1 birinci bağımsız kanonik değişkenin ekonomi setini açıklama gücü ve açıkladığı kısım %31,6'dır. Ekonomi veri setini en çok açıklayan yaşamsal beklenti veri setinin gücü 0,385 dir.

V1 birinci kanonik değişkenin kendi veri seti içindeki değişkenler tarafından açıklanma gücü ve açıklanan varyans oranı %63,2;

U1 birinci bağımsız kanonik değişkenin yaşamsal beklenti veri setini açıklama gücü ve açıkladığı kısım ise %51,8'dir. yaşamsal beklenti veri setini en çok açıklayan ekonomi veri setinin gücü 0,518 dir.

## TARTIŞMA VE SONUÇ

Çalışmada ekonomi değişkenleri ile insan refah ve mutluluğu değişkenlerinin birbiri üzerindeki etkisi ve yönü istatistiksel analizi olan kanonik korelasyon uygulanarak açıklanmıştır. Analizin sonuç kısmında, ekonomi ile yaşamsal beklenti arasındaki ilişki için üç kanonik korelasyon fonksiyonu elde edilmiştir. Üç kanonik korelasyon fonksiyonundan birinci kanonik korelasyon fonksiyonuna ait kanonik katsayı istatistiksel olarak anlamlı bulunmuştur. Anlamlı bulunan 0,906 kanonik katsayısı ile iki veri seti ilişkisinin çok yüksek düzeyde pozitif yönde olduğu görülmüştür. Birinci kanonik korelasyon fonksiyonunu en çok etkileyen değişkenlerin ekonomi veri setinden günlük kişi başı GSYİH ve yaşamsal beklenti veri setinden doğumdaki sağlıklı yaşam beklentisi olduğu görülmüştür.

Kanonik yükler incelendiğinde günlük kişi başı GSYİH endeksi değişkeni ekonomi veri seti için çok yüksek önem arz ederken Doğumda Sağlıklı Yaşam Beklentisi endeksi ve Sosyal Destek görme endeksi yaşamsal beklenti Değer veri seti için yüksek önem göstermektedir.

Çalışmanın sonuçları, literatürde de konu edilen ekonomi alanında yaşanan iyileştirilmiş ve geliştirilmiş koşulların insanın refahına olumlu yönde etki edeceğini ve insanın mutluluğunu doğrudan etkileyeceğini açıklayan görüşlerle tutarlıdır.

Kişi başına GSYİH'nın artırılmasıyla doğumdaki sağlıklı yaşam beklentisi de artacaktır. Bu açıdan bakıldığında hem ekonomik ihtiyaçların karşılanması hem de sağlıklı olacağını düşünen bireylerde mutlu hissetme hali de artacaktır. Bu bakımdan ekonomik olarak gelişmiş ülkelerin mutluluk endeksleri de yüksektir. Mutluluk endeksinin yüksek olduğu ülkelerde ise sağlıklı yaşam beklentisinin yüksek olduğu görülebilir. Bunun yanında yaşamsal beklenti değerlerinden olan sosyal destek görmekte insanların mutluluğunu olumlu etkilemektedir.

Kişi başına GSYİH 'ye ve sağlıklı yaşam beklentisine önem verilmesi ekonomik kalkınmanın da bir göstergesi konumundadır. Aynı zamanda sosyal destek görmekte insan mutluluğunda çok önemli ve etkilidir. Yapılacak ekonomik kalkınma politikalarında insan hayatına dair sağlıklı doğum oranların artırılması, insanlara sosyal destek bulacağı ortamların oluşturulması dikkate alınmalıdır. Bu kriterler dikkate alındığında hem ekonomik kalkınma hemde insan mutluluğu ve refahı artırılmış olacaktır.

## KAYNAKLAR

Efeoğlu R., Azgün S.,2021. Demokrasi ve Mutluluk: BRIC ve MIST Ülkeleri Üzerine Bir Araştırma, Çankırı Karatekin Üniversitesi İktisadi ve İdari Bilimler Fakültesi Dergisi, 11(1): 333-349.

- Güzel S.,2017. Gelir Eşitsizliği, Refah ve Mutluluk, Anemon Muş Alparslan Üniversitesi Sosyal Bilimler Dergisi, 6(3) 389-394.
- Dağdeviren V., Yıldız O.,2017. Gayrisafı Milli Mutluluğun Ekonomik Kalkınmadaki Rolü: Bhutan Krallığı Örneği, Adnan Menderes Üniversitesi Sosyal Bilimler Enstitüsü Dergisi, 4(4): 232-248
- Aydınbaş G., Erdiñç, Z.,2022. Toplum 5.0 Bağlamında Mutluluk ile İlişkilendirilen Faktörlerin Panel Veri Kanıtları, ODÜ Sosyal Bilimler Araştırmaları Dergisi, 12 (3):1309-9302.
- Menevşeoğlu G.,2019. Kanonik Korelasyon Analizi Üzerine Bir İnceleme, Yüksek Lisans Tezi. İnönü Üniversitesi, Sosyal Bilimler Enstitüsü, Malatya, Türkiye.
- Türkmen S., Tıraş H.H, 2022, Brics-T Ülkelerinde Ekonomik Büyüme Ve İnsani Gelişme İlişkisinin Ekonometrik Analizi, Ekonomi ve Araştırma Dergisi,3(2):1-16 .
- Albayrak G,Ş.,2022. Mutluluk Ekonomisi ve Türkiye, Turkish Araştırma Dergisi, 3(5): 57-74
- Aksoy A., Taşkaya S. 2020. Ülkelerin Makroekonomik Göstergeleri ile Mutluluk Düzeyleri Arasındaki İlişki, Üçüncü Sektör Sosyal Ekonomi Dergisi, 55(2):1188-1201.
- Kandemir O.,2021. Dünya Ülkelerinde Sosyal Eşitsizliklerin Mutluluk Düzeyine Etkisi: Lojistik Regresyon Analizi, Uluslararası Avrasya Sosyal Bilimler Dergisi,12(45):612-625.
- Servet O.,2018. Dünya Ülkelerinde Mutluluğu Belirleyen Faktörler Üzerine Bir Uygulama: Sıralı Logit Model, Gelişmekte Olan Ekonomiler ve Politikalar Dergisi, 3(2):1-22
- Alkan F., Çilesiz N.,2022. Mutluluk Ekonomisinin G7 Ülkeleri ve Türkiye Açısından Değerlendirilmesi, Dumlupınar Üniversitesi İİBF Dergisi, 10 (2022): 70-81
- Nurdoğan A.K.,2021. Teknoloji ve İşgücü Piyasası İlişkisinin Kanonik Korelasyon Analizi ile İncelenmesi, Çalışma ve Toplum Dergisi,1(68):97-118.
- Ari O., 2019.İktisat-Mutluluk İlişkisi: Bhutan'ın Sürdürülebilir Kalkınma Modeli Üzerine Bir İnceleme. Hoca Ahmet Yesevi 2. Uluslararası Bilimsel Araştırmalar Kongresi, 6-8 Aralık 2019, Sayfa:75-84 Erzurum, Türkiye.
- Kaya H.,2020.Ekonomik Özgürlük ve Mutluluk Endeksleri Temelinde Ülkeler İçin Kümeleme Analizi. Ankara Hacı bayram Üniversitesi, 20. Uluslararası Ekonometri, Yöneylem Araştırması ve İstatistik Sempozyumu, Mayıs,Sayfa:142-151, Ankara, Türkiye.

#### **Bildirim**

Her koşulda yanımda olan aileme ve çalışmalarımı destekleyen eşime teşekkür ederim.

#### **Çıkar Çatışması**

Yazarlar çıkar çatışması olmadığını beyan etmişlerdir.

#### **Yazar Katkıları**

Cansu KÖK; problemin kurulmasına, verilerin seçilip düzenlenmesine ve istatistiksel analizin uygulanmasına katkı sağlarken Dr. Öğr. Üyesi Muharrem Ünver uygulama yöntemi olan Kanonik Korelasyon Analizi ve İleri İstatistik Tekniklerin uygulanabilirliğine katkı sağlamıştır.

## Examining the Development of Pet Marketing Literature through Bibliometric Analysis

Pınar Özkan<sup>1\*</sup>, İpek Deveci Kocakoç<sup>1</sup>

<sup>1</sup>Dokuz Eylül University, Faculty of Economics and Administrative Sciences, Department of Business Administration, 35140, İzmir, Türkiye

\*Corresponding author e-mail: ipek.deveci@deu.edu.tr

### Abstract

*Pet ownership has become very widespread in recent years, especially with the pandemic. The needs of this ever-increasing number of people have created a new market. Understanding and managing the needs of this market involves various challenges. The main purpose of this study is to conduct a bibliometric analysis of the field of pet marketing research. For this purpose, the articles in the WoS database were searched for various keywords related to “pet consumption” and “pet market” and a data set was created from 762 articles. These articles were then refined according to WoS categories and reduced to 339 articles, and 264 articles were selected for the final analysis by excluding 75 more articles as a result of visual control.*

*This study is expected to reveal the evolution of work in the field, identify key journals, articles and authors, examine the main research streams and identify opportunities and areas for future research. In addition to the Vosviewer package for basic bibliographic analysis, the study used Latent Dirichlet Allocation (LDA) to determine topic distribution and trends, and codes written in Python for trend analysis. LDA analysis aims to discover hidden topics in pet marketing texts and to understand the content of these topics. As a result of the analysis, three main themes were identified: “Pet product marketing and consumer behavior”, “Pet ownership, health and welfare” and “Safety in animal species and pet products”*

**Keywords:** Pet, Marketing, Consumption, Bibliometric analysis, Latent Dirichlet Allocation

### INTRODUCTION

Pets and pet-related products have become an extremely interesting topic that has attracted a great deal of attention and has been researched from various angles in recent years. According to the Web of Science (WoS) database, publications on pet marketing research have increased significantly in the last five years. This indicates a growing interest in topics such as pet welfare, digital marketing and consumer behavior in the academic literature. According to the Oxford Dictionary, a pet is defined as “an animal or bird kept at home for pleasure and not for work or food”. Although there are no reliable global statistics on pet ownership today, studies conducted by different organizations in different countries show that pet ownership rates are increasing day by day.

According to ASPCA® (American Society for the Prevention of Cruelty to Animals®) data, pet ownership rates in the USA have increased significantly with the pandemic (ASPCA, 2021; ASPCApro, 2021). According to a 2021 study, 70% of US households, or about 90.5 million people, own a pet (Rainwalk Pet Insurance, 2023). This increase is associated with many people adopting pets during the pandemic.

Morgan Stanley data says that the pet industry could almost triple to \$277 billion by 2030, thanks to an increase in new owners, favorable demographics and, most importantly, increased spending per pet (Ekonomim, 2023). All this data shows that the pet products industry is growing and diversifying rapidly.

The main purpose of this study is to reveal the impact of this increase and diversification in the pet products market on the academic literature. In the light of this reflection, the secondary objectives are to identify potential study topics for scholars who want to contribute to the field and to give an idea



about possible fields of activity for businesses operating in pet-related fields or entrepreneurs who want to enter the field. This study aims to comprehensively examine the current state of pet marketing research and future research opportunities.

## MATERIAL AND METHODS

### Material:

This study was conducted to examine the changes in the field of pet marketing research and current study topics. The data of the study were obtained from the Web of Science (WoS) database. The WoS database provides detailed bibliographic information such as publication types, authors, article titles, source titles, keywords, abstracts, publication years, author affiliations, funding sources, citation counts and digital object identifiers (DOIs). At the beginning of the study, the query shown in Table 1 was performed using specific keywords (TITLE-ABS-KEY) to identify the articles included in the study. The 762 articles obtained as a result of the query were refined according to WoS categories and reduced to 339 articles. Then, 75 more articles were excluded by visual control and category elimination and 264 articles were selected for the final analysis.

**Table 1.** WoS query and link

<b>WoS Advanced Query</b>	TS=((("pet" OR "pets" OR "cat" OR "cats" OR "dog" OR "dogs" OR "companion animal" OR "companion animals" OR "animal companion" OR "animal companions" OR "aquarium") AND ("marketing" OR "consumer behavior" OR "market strategies" OR "brand loyalty" OR "target marketing" OR "product development" OR "advertising" OR "promotions" OR "retail marketing" OR "customer engagement" OR "service marketing")) NOT ("urban*" OR "tomography" OR "scan" OR "slaughter" OR "beef" OR "calf"))
<b>Query link</b>	<a href="https://www.webofscience.com/wos/woscc/summary/53022838-f1be-4d85-8c27-2fa700de1eb0-e7888193/relevance/1">https://www.webofscience.com/wos/woscc/summary/53022838-f1be-4d85-8c27-2fa700de1eb0-e7888193/relevance/1</a>

### Method:

Bibliometric analysis explores the evolution of research in the selected field, identifies key journals, articles and authors, examines major research streams, and identifies research fronts and opportunities for future progress. Bibliometric approaches are used to uncover emerging trends and research components, as well as to explore the intellectual structure of a particular field in the literature (Donthu et al., 2020, 2021; Khan et al., 2021). Performance analysis was used to identify the field's development trends, prolific authors and journals, and science mapping processes were used to reveal the conceptual structure of the research field (Cobo et al., 2011). To support this analysis, the visualization of similarities technique was used in the study (van Eck & Waltman, 2010, 2014).

Three different tools were used for bibliometric analysis. Vosviewer software was used for various network analysis of the articles. Cluster analysis was performed with Carrot2 web software. Other analyses (word clouds, frequency calculations, topic analysis and keyword analysis) were performed with codes written by the researchers in Python language. The data obtained from the WoS database were extracted in Excel format and used in the analysis. During the analysis of the data, the distribution of the articles according to the years of publication, the most published journals and authors, the number of citations and keyword analysis were performed. In addition, topic modeling analysis was performed using Latent Dirichlet Allocation (LDA) algorithm.

## RESULTS

As a result of the analysis, an increase in the number of publications was observed over the years (Figure1). This increase shows that marketing studies for pets have gained importance in recent years and attracted more attention from researchers.

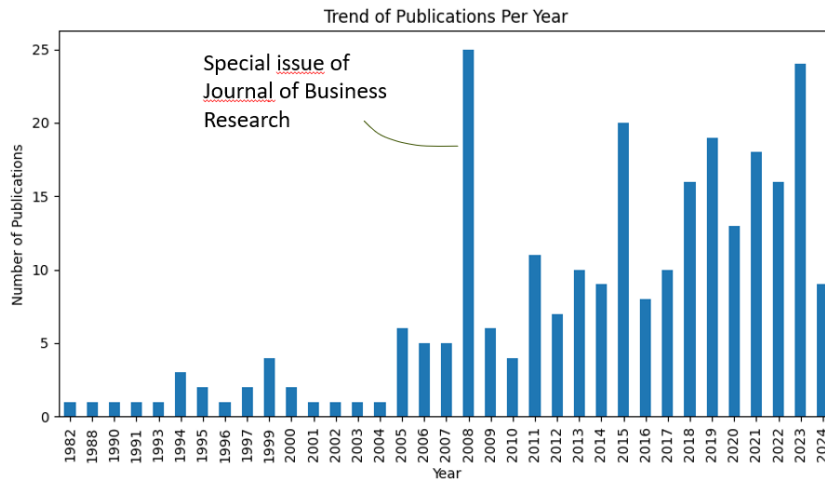


Figure 1. Trend of publications

**Wos Subject Categories:**

Figure 2 presents a visualization of subject categories from the Web of Science (WoS) database, showing the distribution and frequency of publications in the field of pet marketing research. The categories are represented by different colored and sized hexagons, indicating the number of studies within each category. Veterinary Sciences is the most prominent category with 119 studies, indicating a strong focus on animal health and veterinary practices. This visualization underscores the comprehensive and varied academic exploration in this field.

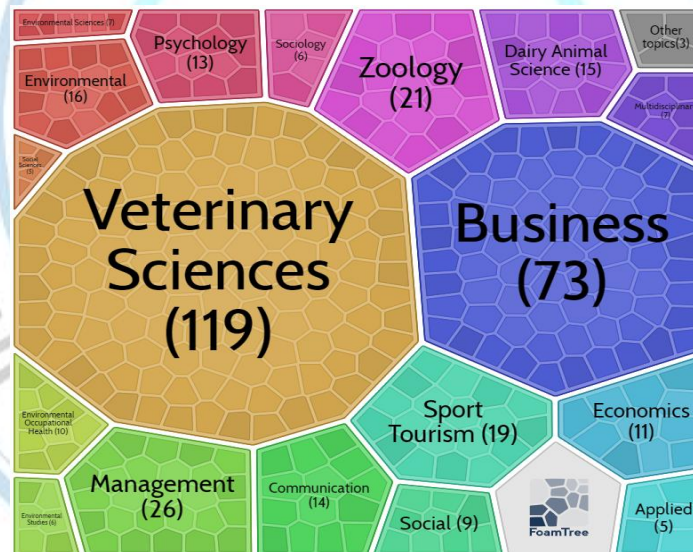


Figure 2. WoS subject categories

**Keyword Analysis:**

Keyword analysis using Python revealed that “dog”, “market”, “anim” and “pet” were the most frequently mentioned keywords (Figure 3). This finding suggests that dogs and pets in general play a central role in marketing research. In addition, marketing and veterinary related terms such as “advertis”, “veterinarian”, “owner” were also frequently used. This suggests that pet ownership and veterinary services play an important role in marketing strategies.

Root word	Frequency	Root word	Frequency
dog	381	advertis	167
market	340	veterinari	167
anim	322	owner	157
pet	320	food	148
studi	278	behavior	147
use	264	social	132
consum	199	effect	126
product	198	adopt	120
cat	180	model	114
practic	174	brand	112
research	170	develop	110

**Figure 3.** Top keywords

**Clustering and Topic Analysis:**

Three main themes were identified in topic modeling and clustering analyses using Latent Dirichlet Allocation (LDA) analysis:

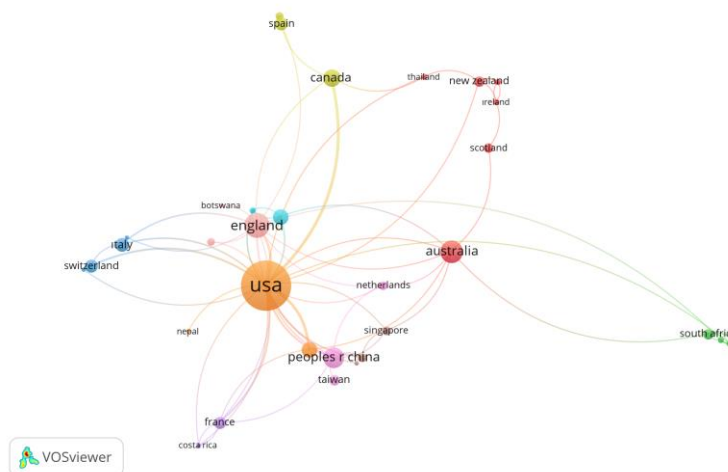
**Pet Product Marketing and Consumer Behavior:** This theme focuses on marketing strategies and consumer behavior of pet products. Research focuses specifically on how dogs are marketed and how consumer behavior is analyzed.

**Pet Ownership, Health and Welfare:** This theme includes studies on the social aspects of pet ownership, health and welfare practices. Keywords such as “adoption” and “welfare” draw attention to the ethical aspects of pet ownership.

**Safety in Animal Species and Pet Products:** This theme focuses on different animal species, especially dogs and cats, and the safety of pet products. It includes research on the use, safety and adverse effects of products.

**Co-authorship Analysis:**

The co-authorship map in Figure 4, generated using VOSviewer, illustrates the collaborative relationships among researchers in the field of pet marketing across various countries. The USA is the central hub with the largest node, indicating the highest level of collaboration, particularly with countries like the UK, Australia, China, and Canada. The UK also shows strong connections with other European countries and the USA. Australia is well-connected with both the USA and other countries like New Zealand and South Africa. China, while closely collaborating with the USA and Australia, also maintains connections with other Asian countries. Overall, the map highlights a global network of research collaborations, with significant contributions from North America, Europe, Asia, and Oceania.



**Figure 4.** Co-authorship map



**Citation Analysis:**

The citation analysis was evaluated based on the number of citations of the articles. As a result of the analysis, 67 articles received no citations, 153 articles received five or more citations and 48 articles received more than ten citations. The most cited article was Hirschman's study titled “Consumers and their animal companions” published in 1994, which received 214 citations (Table 2). This shows that a small number of studies greatly influence the field and are cited by a wide academic audience.

**Table 2.** Top 10 cited articles

Authors	Article title	Publication Year	Journal Title	Times Cited
Hirschman, Ec	Consumers and their animal companions	1994	JOURNAL OF CONSUMER RESEARCH	214
Berger, J; Fitzsimons, G	Dogs on the street, pumas on your feet: How cues in the environment influence product evaluation and choice	2008	JOURNAL OF MARKETING RESEARCH	192
Gengler, Ce; Reynolds, Tj	Consumer understanding and advertising strategy - analysis and strategic translation of laddering data	1995	JOURNAL OF ADVERTISING RESEARCH	171
Axsen, J; Tyreehageman, J; Lentz, A	Lifestyle practices and pro-environmental technology	2012	ECOLOGICAL ECONOMICS	158
Wancket, LM	Animal Models for Evaluation of Bone Implants and Devices: Comparative Bone Structure and Common Model Uses	2015	VETERINARY PATHOLOGY	148
Hendrick, Mj; Shofer, Fs; Goldschmidt, Mh; Haviland, Jc; et al.	Comparison of fibrosarcomas that developed at vaccination sites and at nonvaccination sites in cats - 239 cases (1991-1992)	1994	JOURNAL OF THE AMERICAN VETERINARY MEDICAL ASSOCIATION	145
Sasser, Sl; Koslow, S	Desperately seeking advertising creativity: Engaging an Imaginative 3Ps Research Agenda	2008	JOURNAL OF ADVERTISING	120
Keaveney, SM	Equines and their human companions	2008	JOURNAL OF BUSINESS RESEARCH	95
Tesler, Le; Malone, Re	Ethical Conduct in Public and Private Arenas Corporate Philanthropy, Lobbying, and Public Health Policy	2008	AMERICAN JOURNAL OF PUBLIC HEALTH	84
Hirschman, EC	Men, dogs, guns, and cars - The semiotics of rugged individualism	2003	JOURNAL OF ADVERTISING	79

**DISCUSSION AND CONCLUSION**

This study comprehensively examines the changing nature of pet marketing research through bibliometric analysis. The results show that the number of publications in this field has increased in recent years. Keyword analysis revealed that terms related to dogs and pets in general play a central role in marketing studies. This highlights the importance of understanding consumer behavior and brand positioning in the pet products market.

Cluster and topic modeling analyses identified three main themes: pet product marketing and consumer behavior, pet ownership health and welfare, and safety in pet products. These themes reveal the varied nature of pet marketing research and show that it encompasses various dimensions such as consumer behavior, veterinary health, and product safety. The prominence of keywords related to digital marketing channels and veterinary medicine suggests that these areas are particularly important in current research.

Citation analysis shows that a small number of studies have had a major impact on the field and are cited by a wide academic audience. The high citation counts of these studies suggest that they are widely accepted in the field and have had a significant impact. It would be beneficial for future research to delve deeper into the dynamics of pet marketing, focusing on the identified key themes and using interdisciplinary approaches.

In conclusion, this bibliometric study reveals important trends and influential studies in pet marketing research. The increasing volume of publications and the diversity of topics covered suggest that the field is vibrant and expanding. Researchers are encouraged to build on these findings to conduct longitudinal studies and explore emerging trends. Such studies will both increase academic knowledge and provide valuable insights for industry professionals operating in the growing pet market.

## References

- ASPCA, 2021. New ASPCA Survey Shows Overwhelming Majority of Dogs and Cats Acquired During the Pandemic Are Still in Their Homes, Access address: <https://www.asPCA.org/about-us/press-releases/new-asPCA-survey-shows-overwhelming-majority-dogs-and-cats-acquired-during>; Date of access: 20.04.2024
- ASPCAPRO, 2021. New ASPCA Survey: Vast Majority of Dogs and Cats Acquired During Pandemic Still in Their Homes, Access address: <https://www.asPCapro.org/resource/new-asPCA-survey-vast-majority-dogs-and-cats-acquired-during-pandemic-still-their-homes>; Date of access: 21.04.2024.
- Cobo, MJ, López-Herrera, AG, Herrera-Viedma, E, Herrera, F. 2011. An approach for detecting, quantifying, and visualizing the evolution of a research field: a practical application to the Fuzzy Sets Theory field, *Journal of Informetrics*, 5(1): 146-166, doi: 10.1016/j.joi.2010.10.002.
- Donthu, N, Kumar, S, Pattnaik, D. 2020. Forty-five years of journal of business research: a bibliometric analysis, *Journal of Business Research*, 109:1-14, doi: 10.1016/j.jbusres.2019.10.039.
- Donthu, N, Kumar, S, Mukherjee, D, Pandey, N, Lim, WM. 2021. How to conduct a bibliometric analysis: an overview and guidelines, *Journal of Business Research*, 133: 285-296, doi: 10.1016/j.jbusres.2021.04.070.
- Ekonomim, 2023. Evcil hayvan pazarı 277 milyar dolara koşuyor, Access address: <https://www.ekonomim.com/sectorler/evcil-hayvan-pazari-277-milyar-dolara-kosuyor-haberi-691191>, Date of access: 21.05.2024.
- Khan, A, Goodell, JW, Hassan, MK, Paltrinieri, A. 2021. A bibliometric review of finance bibliometric papers, *Finance Research Letters*, 47, 102520, doi: 10.1016/j.frl.2021.102520.
- Oxford Dictionary, Access address: [pet noun - Definition, pictures, pronunciation and usage notes | Oxford Advanced Learner's Dictionary at OxfordLearnersDictionaries.com](https://www.oxfordlearnersdictionaries.com/definition/english/pet); Date of access: 21.05.2024.
- Rainwalk Pet Insurance, (2023). Pet Ownership Statistics 2023, Access address: <https://rainwalkpetinsurance.com/pet-ownership-statistics/>; Date of access: 10.05.2024.
- van Eck, NJ, Waltman, L. 2010. Software survey: VOSviewer, a computer program for bibliometric mapping, *Scientometrics*, Vol. 84 No. 2, pp. 523-538, doi: 10.1007/s11192-009-0146-3.
- van Eck, NJ, Waltman, L. 2014. "Visualizing bibliometric networks", Ding, Y., Rousseau, R. and Wolfram, D. (Editors), *Measuring Scholarly Impact: Methods and Practice*, Springer International Publishing, 285-320, doi: 10.1007/978-3-319-10377-8\_13.

**6 Şubat Deprem Felaketi Ardından Uygulanan Uzaktan Eğitim Sistemine Bakışın İncelenmesi ve Değerlendirilmesi: Ankara Hacı Bayram Veli Üniversitesi İktisadi ve İdari Bilimler Fakültesi ve Ankara Üniversitesi Fen Fakültesi Karşılaştırması**

**Osman Kececi<sup>1\*</sup>, Döndü Soytürk<sup>1</sup>, Şahika Gökmen<sup>2,3</sup>**

<sup>1</sup>Lisans Öğrencisi, Ekonometri Bölümü, İktisadi ve İdari Bilimler Fakültesi, Hacı Bayram Veli Üniversitesi, 06500, Ankara, Türkiye

<sup>2</sup>Doç. Dr., Ekonometri Bölümü, Ankara Hacı Bayram Veli Üniversitesi, İktisadi ve İdari Bilimler Fakültesi, Ekonometri Bölümü, 06500, Ankara, Türkiye

<sup>3</sup>Researcher, Statistics Department, Uppsala University, Uppsala, Sweden

\*Sorumlu yazar e-mail: osman.kececi@hbv.edu.tr

**Özet**

Uzaktan eğitim, öğretici ve öğrenenin farklı mekânlarda olduğu, özel ders tasarımı ve teknolojilerini gerektiren planlanmış açık erişimli öğrenme olarak tanımlanmaktadır. Bu bakımdan, bilgi teknolojileri ile uzaktan eğitim arasındaki bağı oldukça kuvvetli olduğu söylenebilir. Türkiye’de uzaktan eğitim, özellikle Covid-19 salgın sürecinde uygulanmaya başlanmış olan bir eğitim yöntemi olarak karşımıza çıkmaktadır. Covid-19 süreci içerisinde üniversite öğrencileri yaklaşık 1,5 yıl boyunca uzaktan eğitim görmüş ve bu sürecin çıktıları literatürde pek çok araştırmacı tarafından incelenmiştir. Araştırmacılar, bu çalışmaların ortak yanı olarak; eksik ve olumlu yanları ortaya çıkmış bir sistemin daha iyi bir eğitim ve öğretim sürecine destek olabileceğini belirtmişlerdir. Buna ek olarak, Covid-19 sürecinin ani başlangıcıyla pek çok üniversitenin uzaktan eğitim süreçlerine önceden hazırlanmaları için olanak bulamadığı da ifade edilmiştir. Ancak ani başlayan bu uzaktan eğitim süreci, üniversiteler için Haziran 2021 zamanından itibaren sona erse de hem yurt dışında hem Türkiye’de pek çok üniversite uzaktan eğitim sistemiyle sertifika ve diploma programları açmaya başlamıştır. Diğer yandan ülkemizde 6 Şubat 2023 tarihinde 110 bin kilometrekarelik alanda etkili olan iki büyük deprem meydana gelmiştir. Meydana gelen depremler toplam 11 ilde önemli miktarda hasar ve yıkım meydana getirmesiyle birlikte Yükseköğretim Kurulu (YÖK), 2022-2023 bahar döneminde üniversitelerde tekrardan uzaktan eğitime geçilmesi kararı almıştır. Bu kararın nedenleri arasında, yaşanan felaketler sonucu, öğrencilerin ev ve ailelerini kaybetmesi, depremedeler için öğrenci yurtlarının kullanılması gibi faktörler bulunmaktadır. Her ne kadar uygulamalı bilimler gibi bazı alanlar bu kararın dışında tutulsa da üniversitelerin geçmiş deneyimleri sonucu uzaktan eğitim sürecine daha hızlı adapte olması beklenmiştir. Buna bağlı olarak üniversiteler bu süreçte uzaktan eğitim sürecini geliştirmek ve iyileştirmek adına çeşitli adımlar atmış ve böylece Covid-19 süreci ile kullanmaya başladıkları uzaktan eğitim sistemlerini daha etkili kullanmak yönünde çaba göstermişlerdir. Literatürde bu alanda yapılan çalışmalar incelendiğinde iki üniversitenin uzaktan eğitim sistemini karşılaştıran bir çalışma bulunamamış ve çalışmaların büyük bir kısmının tekil olarak bir bölümü veya öğrencileri hedef aldığı görülmüştür. Bu nedenle bu çalışma, Ankara Hacı Bayram Veli Üniversitesi İktisadi ve İdari Bilimler Fakültesi ile Ankara Üniversitesi Fen Fakültesi öğrencilerinin deprem sonrası uygulanmış olan uzaktan eğitim sürecine yönelik algılarını ve deneyimlerini karşılaştırmayı ve farklı alanlarda eğitim gören öğrencilerin uzaktan eğitime bakışlarını incelemeyi amaçlamaktadır. Araştırma kapsamında uzaktan eğitim süreci hakkında, iki fakülte öğrencilerinden saha çalışması ve anket yoluyla alınan görüşler toplanmış ve şu üç boyut çerçevesinde incelenmiştir: uzaktan eğitime erişim ve katılım, uzaktan eğitimin organizasyonu ve uzaktan eğitimin niteliği. Çalışmada derlenen veriler istatistiksel yöntemlerle ve günümüz büyük veri bilimi çalışmalarında kullanılan veri görselleştirme teknikleriyle incelenmiştir. Elde edilen bulguların, en başta ilgili fakülteler, eğitim kurumları ve ardından söz konusu alanın politika yapımcıları tarafından kullanılması beklenmektedir. Söz konusu idarelerin elde edilen bulgulardan yararlanarak uzaktan eğitim süreçlerinin iyileştirilmesine destek olabileceği ve öğrenci deneyiminin geliştirilmesine yönelik önemli adımlar atabileceği ve bu alanda literatüre katkıda bulunacağı düşünülmektedir.

**Anahtar Kelimeler:** Uzaktan Eğitim, Eğitim Sistemi, Saha Araştırması, Veri Görselleştirme



## 1. GİRİŞ

Uzaktan eğitim, öğretici ve öğrenenin farklı mekânlarda olduğu, özel ders tasarımı ve teknolojilerini gerektiren planlanmış açık erişimli öğrenme olarak tanımlanabilir. Bu eğitim modelinde öğrenciler, genellikle internet üzerinden eğitim materyallerine erişir ve dersleri takip ederler. Uzaktan eğitim, belirli bir merkezden yönetilen ve öğrencilerin bireysel olarak kendi hızlarında öğrenmelerini sağlayan bir öğretim yöntemidir. Uzaktan eğitim, özellikle internetin yaygınlaşmasıyla birlikte 1990'ların sonlarından itibaren giderek daha popüler hale gelmiştir. Ancak, kökleri çok daha eskiye dayanmaktadır. Erken dönemlerde (19. Yüzyıl), mektupla eğitim şeklinde başlayan uzaktan eğitim örnekleri görülmekle birlikte; 20. Yüzyıl ortalarında, radyo ve televizyon gibi teknolojiler eğitimde kullanılmaya başlanmış, ardından 1980'lerde bilgisayarların yaygınlaşması ve 1990'larda internetin doğuşuyla uzaktan eğitim yeni bir boyut kazanmıştır. Özellikle 2000'lerden itibaren ise online eğitim platformlarının gelişimiyle birlikte bu eğitim türü büyük bir ivme kazanmıştır. Türkiye'de ise uzaktan eğitim, ilk defa 1927'de eğitim sorunlarının görüşüldüğü bir toplantıda ele alınmış ancak o dönemde uygulamaya geçirilememiştir. Ancak, 1982'de Anadolu Üniversitesi Açık Öğretim Fakültesi'nin kurulmasıyla uzaktan eğitim kurumsallaşmıştır. AÖF, ders kitapları ve televizyon dersleri aracılığıyla geniş öğrenci kitlesine eğitim vermiş ve bu model diğer üniversitelerde de benimsenerek yaygınlaşmıştır. (Türk Eğitim Vakfı, 2024)

Tüm bu gelişmeler içerisinde, 2020 yılında ortaya çıkan COVID-19 pandemisi, uzaktan eğitimin küresel ölçekte patlama yapmasına neden olmuştur. Salgının yayılmasını önlemek amacıyla, dünya genelinde okullar ve üniversiteler hızla kapatılmış ve eğitim sürecinin uzaktan eğitim sistemi ile devam etmesi zorunlu hale gelmiştir. Türkiye'de de Mart 2020'de yüz yüze eğitime ara verilerek uzaktan eğitime geçiş yapılmış, MEB ve YÖK tarafından hızlı bir şekilde uzaktan eğitim platformları devreye sokulmuştur. Bu süreçte uygulanan uzaktan eğitimin, öğrenciler ve öğretmenler üzerinde birçok avantajı ve dezavantajı olmuştur. Uzaktan eğitimin avantajları arasında erişim ve esneklik, zaman yönetimi ve teknolojik imkânlar yer alırken; dezavantajları arasında ise erişim sorunları, etkileşim eksikliği, motivasyon ve disiplin sorunları gözlemlenmiştir.

Literatürde bu dönemi inceleyen ve öğrenci ile öğretmenlerin bakış açılarından uzaktan eğitim sistemini ve uzaktan eğitimin getirdiği olumlu ve olumsuz yanları araştıran çalışmalar mevcuttur. Bu çalışmalar arasında Erzen ve Ceylan (2020), Kırmızıgül (2020) ve Çetin ve Akduman (2022)'in çalışmaları örnek gösterilebilir. Erzen ve Ceylan (2020), yaptığı çalışmada COVID-19 salgını ile birlikte gelen uzaktan eğitim sürecinin uygulanmasındaki sorunlara değinirken; Kırmızıgül (2020), aynı yıl ele aldığı çalışmada COVID-19 salgınının getirdiği eğitim sürecinin olumlu ve olumsuz yanlarını değerlendirmiştir. Çetin ve Akduman ise COVID-19 salgını sonrası yaşanan uzaktan eğitimde öğretmen ve öğrenci görüşlerini toplayıp değerlendirmiştir.

Covid-19 pandemi sürecinde uzaktan eğitim sürecinin ani ve yoğun bir şekilde deneyimlenmesinin ardından ülkemizde 6 Şubat 2023 tarihinde 110 bin kilometrekarelik alanda etkili olan iki büyük deprem meydana gelmiştir. Okulların hasar görmesi ve güvenlik endişeleri nedeniyle Millî Eğitim Bakanlığı (MEB) ve Yükseköğretim Kurulu (YÖK), hızlı bir şekilde uzaktan eğitim platformlarını devreye sokmuş ve böylece 6 Şubat'taki deprem felaketi sonrasında, COVID-19 salgını döneminde olduğu gibi tekrar uzaktan eğitime geçilmiştir. Pandemi sürecinin yakın sürede deneyimlenmesinden dolayı deprem felaketi sonrasında uygulanan uzaktan eğitim sürecinin, COVID-19 salgını sonrasında uygulanan uzaktan eğitim sürecinden daha az sorunlu, daha verimli ve daha kaliteli olması beklenmektedir. Bunun sebepleri arasında bu süreçte yapılan iyileştirme çalışmaları, eksikliklerin belirlenmesi ve giderilmesi gibi faktörler yatmaktadır. Dolayısıyla COVID-19 salgını sırasında kazanılan deneyimler ve geliştirilen teknolojik altyapılar, deprem sonrası uzaktan eğitimin daha etkili ve verimli olmasına katkı sağlayacağı düşünülmektedir. Ayrıca öğrenci ve öğretmenlerin uzaktan eğitime daha aşına olmalarının da sürecin daha sorunsuz ilerlemesine katkı sağlayabileceğini düşündürmektedir. Bu durum, yapılan çalışmalarda deprem felaketi sonrasında uygulanan uzaktan eğitim sürecinin işleyişine dikkat çekmeye başlamıştır.

Bu alandaki literatüre bakıldığında, mevcut çalışmalarda 6 Şubat deprem felaketi sonrasında iki üniversite bazında uygulanan uzaktan eğitim sistemlerini karşılaştıran detaylı bir araştırmanın bulunmadığı gözlemlenmektedir. Ancak benzer konuda yapılmış bazı çalışmalar bulunmaktadır. Fıratlı (2023), 6 Şubat 2023 depremleri sonrasında zorunlu uzaktan eğitime geçiş nedenlerine göre üniversite öğrencilerinin uzaktan eğitim algılarının farklılaşmasını incelemiştir. Özkaya ve diğerleri (2023) ise

çevrimiçi eğitim uygulamasının İktisadi ve İdari Bilimler Fakültesi (İİBF) öğretim üyeleri üzerindeki etkilerini ele almıştır. Mete ve diğerleri (2024), meslek yüksekokullarındaki uzaktan eğitimi, öğrenci ve öğretim elemanları açısından değerlendirmiştir. Bu çalışmaların ortak yönü tekil bazda bir fakültenin öğrencilerinin veya öğretim üyelerinin uzaktan eğitim sistemine bakışının incelenmesidir. Diğer yandan bu çalışmalarda öğrencilerin eğitim gördükleri alanın farklılığına dikkat edilmediği ve hatta farklı okulların sistemlerinin karşılaştırılmasına olanak sağlanmadığı gözlenmiştir. Bu bağlamda bu çalışmada, her biri farklı disiplinlere odaklanan iki fakültenin deprem felaketi sonrasındaki uzaktan eğitim sürecinin incelenmesi amaçlanmıştır. Buna bağlı olarak, birbirine yakın konumlarda yer alan Fen Fakültesindeki uygulamalı derslerle sosyal bilimler fakültesindeki daha teorik odaklı dersler arasındaki farkları ve benzerlikleri anlamak bu çalışmanın motivasyonunu oluşturmaktadır. Uygulamalı derslerin daha fazla interaktif ve laboratuvar tabanlı olması, Fen Fakültelerindeki uzaktan eğitim süreçlerini sosyal bilimler fakültelerine kıyasla farklı kılabilmektedir. Diğer yandan, sosyal bilimler fakültelerindeki daha teorik derslerin, uzaktan eğitim platformlarında nasıl sunulduğunu ve öğrenci katılımını nasıl etkilediğini anlamak da önemlidir. Bu bağlamda çalışmada Ankara'da yer alan iki devlet üniversitesinden anket yoluyla derlenen veriler, veri görselleştirme teknikleriyle incelenmiş ve bu sayede iki fakültede uygulanan uzaktan eğitim sistemlerinin güçlü ve zayıf yönleri belirlenmeye çalışılmıştır. Çalışmadan elde edilecek bulguların gelecekteki eğitim politikalarının ve uzaktan eğitim uygulamalarının geliştirilmesine katkıda bulunması beklenmektedir.

Bu doğrultuda çalışma 4 bölümden oluşmaktadır. Söz konusu Giriş bölümünü takiben ikinci bölümde Veri Görselleştirme ardından Veri Toplama Süreci ve Bulgular ele alınmış olup; üçüncü bölümde Tartışma ve Öneriler bölümü yer almaktadır. Araştırmanın ilerleyen bölümlerinde ölçeklerin kısaltmaları kullanılmıştır.

## 2. VERİ GÖRSELLEŞTİRME

Veri görselleştirme, verilerin grafikler, tablolar veya haritalar gibi görsel öğeler kullanılarak anlaşılabilir hale getirilmesini kapsamaktadır. Veri görselleştirme teknikleri, karmaşık veri kümelerini analiz etmek, trendleri belirlemek, ilişkileri görselleştirmek ve sonuçları görsel olarak daha açık bir şekilde iletmek için yaygın olarak kullanılmaktadır. Sonuçların görsel olarak iletilmesi, karmaşık bilgileri daha anlaşılır hale getirerek araştırmacıların ve karar vericilerin büyük veri kümelerini hızlı ve etkili bir şekilde anlamalarına yardımcı olmaktadır. (Few, 2006; Tufte, 2001)

Veri görselleştirme genellikle çeşitli grafik türleri kullanılarak yapılır. Bazı yaygın grafik türleri şunlardır:

- Çizgi Grafikleri: Zaman içindeki değişiklikleri göstermek için kullanılır.
- Sütun ve Çubuk Grafikleri: Kategorilere veya zaman aralıklarına göre verilerin karşılaştırılması için kullanılır.
- Pasta Grafikleri: Bir bütünün parçalarının oransal dağılımını göstermek için kullanılır.
- Nokta Grafikleri: İki değişken arasındaki ilişkiyi göstermek için kullanılır. Örneğin, bir nokta grafiği, bir kişinin yaşına göre kilosunu gösterebilir.
- Haritalar: Coğrafi verileri görselleştirmek için kullanılır. Örneğin, bir harita, bir ülkenin farklı bölgelerindeki nüfusu gösterebilir.

Bu görselleştirme tekniklerinin yanı sıra, daha karmaşık veri kümelerini analiz etmek için interaktif grafikler ve görselleştirmeler de kullanılabilir.

Sahip olduğu özellikler bakımından veri görselleştirme teknikleri, veri analitiği ve karar alma süreçlerinde önemli bir araç olarak görülmekte olup bilgiyi daha erişilebilir hale getirdiğinden günümüz çalışmalarında sıklıkla tercih edilen bir araç haline gelmektedir.

## 3. VERİ TOPLAMA SÜRECİ VE BULGULAR

### 3.1 Veri Toplama Süreci

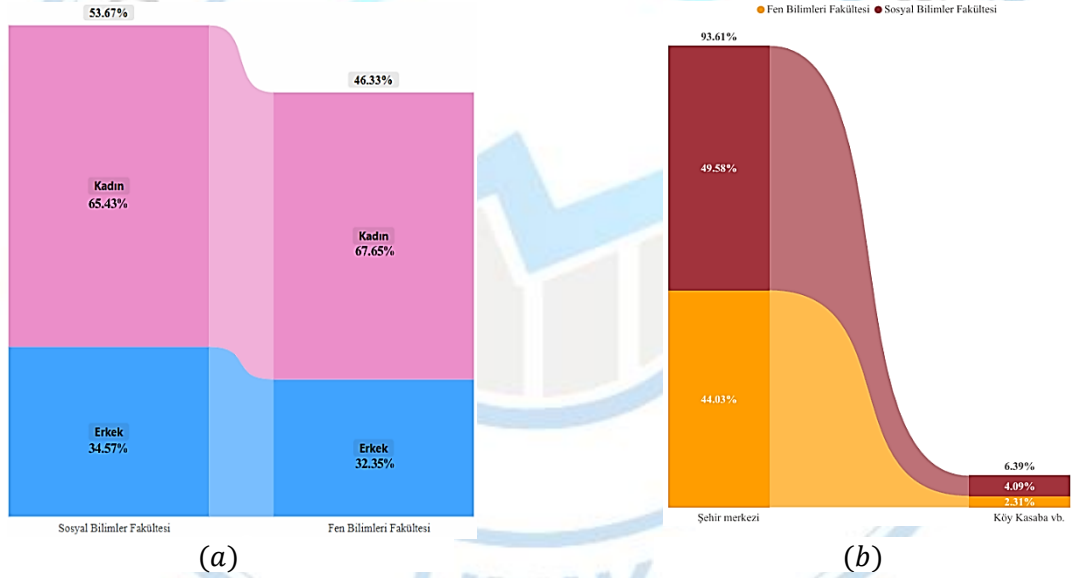
Araştırmada veri toplama yöntemi olarak anketler kullanılmıştır. Ankara Hacı Bayram Veli Üniversitesi

İktisadi ve İdari Bilimler Fakültesi ve Ankara Üniversitesi Fen Fakültesi lisans programlarını 2023-2024 bahar dönemini takip eden öğrencilerden oluşan bir örneklem üzerinde çalışılmıştır. Sosyal bilimler fakültesinde yaklaşık 2100 öğrenci bulunurken, Fen fakültesinde yaklaşık 2200 öğrenci yer almaktadır. Buna bağlı olarak %95 güven düzeyinde orantılı olarak belirlenen minimum örneklem hacimlerinin üzerinde bir katılım (Sosyal bilimler fakültesinden 512; fen bilimleri fakültesinden 442 olmak üzere toplam 954 kişi) elde edilmiştir.

Anket çalışması süreci, yüz yüze yürütülen saha çalışması ve Google Anketler yoluyla yürütülmüştür. Anketimizde toplamda 24 soru yer almaktadır; bunlardan on tanesi likert ölçeğiyle, altısı ise evet-hayır formatındadır. Likert sorular, öğrencilerin uzaktan eğitimde almış oldukları eğitimin genel kalitesini ve memnuniyetini değerlendirmek için oluşturulmuştur. Ayrıca öğrencilerin COVID-19 pandemisinde uygulanan uzaktan eğitimin, 6 Şubat deprem felaketi sonrası uygulanan uzaktan eğitimi ile karşılaştırabilecekleri bir soru yer almaktadır.

### 3.2 Bulgular

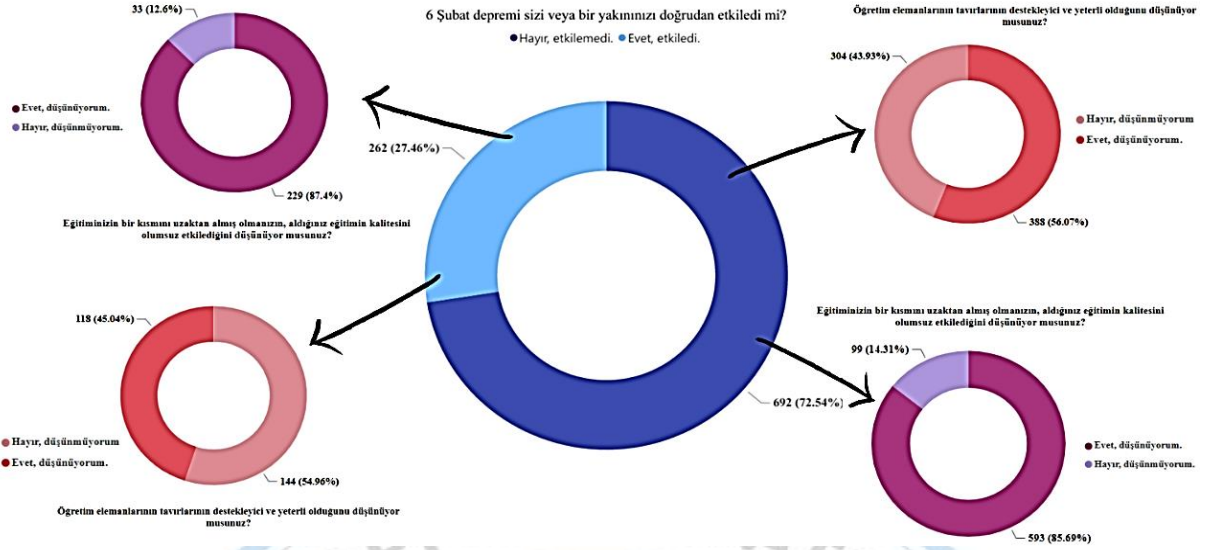
Veri toplama süreci sonrasında elde edilen veriler uygun analiz ortamına aktarılmış ve öncelikle oluşturulan anket sorularındaki ölçeklerin iç tutarlılıkları Cronbach'ın alfa ( $\alpha$ ) katsayısı ile kontrol edilmiştir. Bu katsayı söz konusu anket çalışması için (0.82) olarak elde edilmiş olup; söz konusu değer, anketin kabul edilebilir iç tutarlılıkta ve ölçeklerin her birinin öğrencilerin görüşlerini gereğince yansıtılabildiğini göstermektedir. Elde edilen veriler analize hazır hale getirildikten sonra veri görselleştirme teknikleri kullanılarak farklı alanlarda eğitim gören öğrencilerin uzaktan eğitim hakkındaki görüşleri incelenmiş ve karşılaştırılmıştır.



Şekil 1. (a) Katılımcıların Okudukları Fakülteye Göre Cinsiyet Dağılımı (%) ve (b) Katılımcıların Okudukları Fakülteye Göre Yerleşim Yeri Dağılımı (%)

Katılımcıların genel demografik özellikleri incelendiğinde, örneklemin çoğunluğunu kadın öğrencilerin (%66,43) oluşturduğu ve erkek katılımcıların ise azınlıkta olduğu (%34,57) görülmektedir. Cinsiyetin fakülteye göre dağılımı ise Şekil 1(a)'da paylaşılmıştır. Bu oran, kadın katılımcıların erkek katılımcılara göre oldukça fazla olduğunu göstermektedir. Bu durum çalışmadan elde edilen bulgularda kadın bakış açısının daha belirgin olabileceği ihtimalini doğurmaktadır. Öğrencilerin okudukları fakülteye ilişkin yerleşim yeri dağılımı ise Şekil 1(b)'de paylaşılmıştır. Buna göre, katılımcıların %93,61'i şehir merkezinde yaşarken %6,39'u ise köy, kasaba gibi yerlerde yaşadığını belirtmiştir. Buna göre, büyük çoğunluk şehir merkezinde yaşadığından araştırmanın daha çok şehirde yaşayan öğrencilerin deneyim ve görüşlerine dayandığı da önemli bir sınırlılık olarak karşımıza çıkmaktadır.



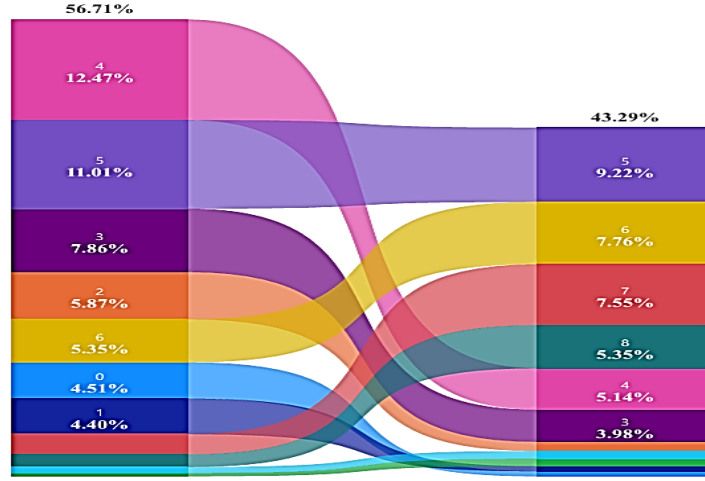


Şekil 2. (a) 6 Şubat depremi sizi veya yakınınızı doğrudan etkiledi mi? (%), "Eğitiminizin bir kısmını uzaktan almış olmanızın aldığınız eğitimin kalitesini olumsuz etkilediğini düşünüyor musunuz?" (%), "Öğretim elemanlarının tavırlarının destekleyici ve yeterli olduğunu düşünüyor musunuz?" (%)

Şekil 2, pasta grafikleri ile katılımcıların depremden etkilenme durumuna göre aldıkları eğitimin kalitesini ve öğretim elemanlarının destekleyici tavırlarına verdikleri yüzdeleri göstermektedir. Buna göre Şekil 2 incelendiğinde, katılımcıların önemli bir kısmının (%27,46) depremden doğrudan veya dolaylı bir şekilde etkilendiği, %72,54'ünün ise depremden etkilenmediği görülmüştür. Bununla birlikte, "Eğitiminizin bir kısmını uzaktan almış olmanızın aldığınız eğitimin kalitesini olumsuz etkilediğini düşünüyor musunuz?" sorusuna baktığımızda depremden etkilenen ve etkilenmeyen öğrencilerin yanıtları arasında çok küçük bir fark olduğunu görmekteyiz. Genel anlamda da katılımcıların uzaktan eğitimden almış oldukları eğitimin kalitesinden memnun olmadığını söyleyebiliriz. Katılımcıların büyük bir çoğunluğu (%87,4), uzaktan eğitimin aldıkları eğitimin kalitesini olumsuz etkilediğini düşünüyor. Bu, uzaktan eğitimde kaliteyle ilgili ciddi endişeler olduğunu ve mevcut uzaktan eğitim sisteminin iyileştirilmesi gerektiğini gösterebilir. Bir diğer soruda ise "Öğretim elemanlarının tavırlarının destekleyici ve yeterli olduğunu düşünüyor musunuz?" öğrencilerin çoğunluğu (%54,96) öğretim elemanlarının destekleyici ve yeterli olduğunu düşünüyor. Ancak, %45,04'lük bir kesim de bu görüşe katılmıyor. Bu, öğretim elemanlarının destekleyici tutumlarının geliştirilmesi gerektiğini gösterir. Bu anket sonuçları, katılımcıların çoğunluğunun depremden doğrudan etkilenmediğini, ancak uzaktan eğitimin kalitesine dair olumsuz görüşlerin yaygın olduğunu göstermektedir. Öğretim elemanlarının tutumlarının özellikle depremden zarar gören öğrenciler tarafından destekleyici ve yeterli bulunmaması, uzaktan eğitim sürecinde karşılaşılan önemli bir sorun olarak dikkat çekmektedir.

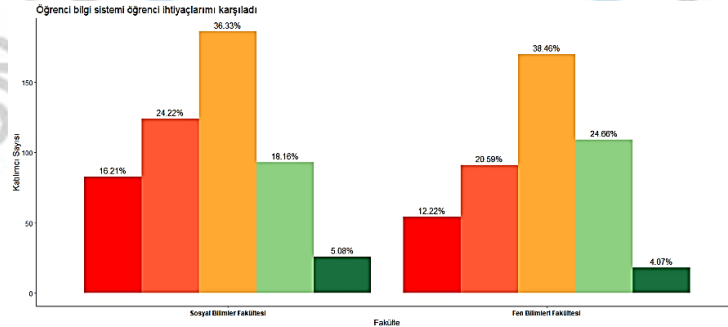
Şekil 3'te sunulan Şerit grafik ile "Uzaktan Eğitim Dönemini Pandemi Dönemi ile Karşılaştırma" sorusu ve "Üniversitenizin Uzaktan Eğitim Sürecini ve İşleyişini Pandemi Dönemindeki Uzaktan Eğitime Göre Daha İyi Yönettiğini Düşünüyor Musunuz" sorularının karşılaştırması yer almaktadır. Uzaktan eğitimde pandemiye göre 4 puan verenlerin yaklaşık %12,47'si, üniversitelerinin uzaktan eğitimi iyi yönetmediklerini düşünenlerin %5,14'ünü oluşturuyor. Pandemi dönemine göre uzaktan eğitime adapte olabilen öğrencilerin süreçten daha memnun olduğu gözlenirken pandemi dönemine göre uzaktan eğitime adapte olamayan öğrenciler süreçten daha az memnun oldukları bir yapı sergilemektedir. Diğer yandan grafikte, sol taraftaki düşük puanların sağ tarafta geçtiğinde alt segmentlerde yer alması öğrencilerin süreçten daha memnun olduklarını ve bu memnuniyetin puanlara yansımalarını göstermektedir.

Uzaktan Eğitim Dönemini Pandemi Dönemine İle Karşılaştırma  
Puan 0 1 2 3 4 5 6 7 8 9 10



Üniversitenizin uzaktan eğitim sürecini ve işleyişini pandemi dönemindeki uzaktan eğitime göre daha iyi yönettiğini düşünüyor musunuz?

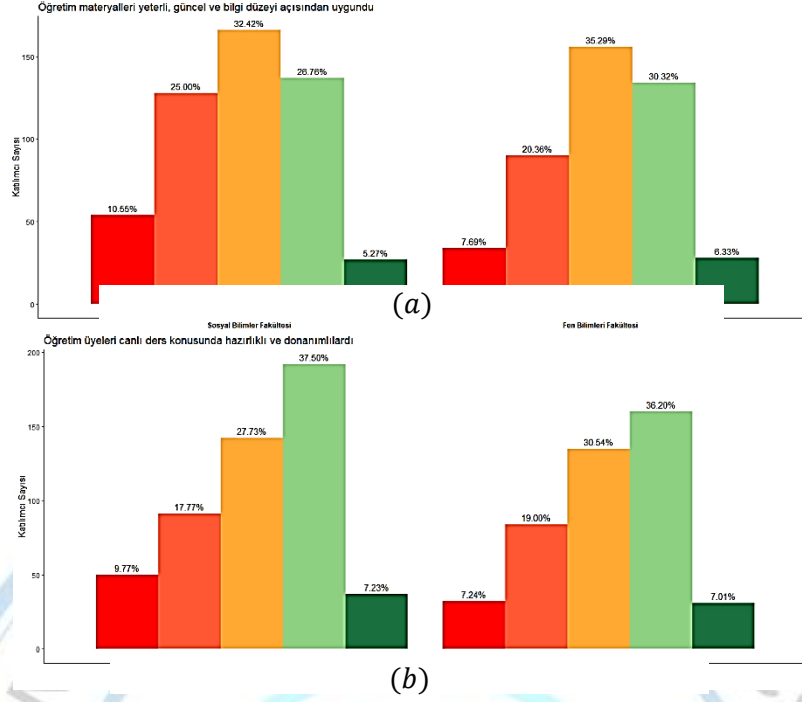
“Yönettiğini Düşünüyor Musunuz” (%)



Şekil 4. “Öğrenci Bilgi Sistemi Öğrenci İhtiyacını Karşıladi” (%)

Şekil 4’de Fen fakültesi öğrenci bilgi sisteminin, öğrenci gereksinimlerini karşılamada yetersiz olduğu gözlemlenmektedir. Öğrenciler, sınav tarihleri, ders kayıtları ve ödevlere erişim konusunda kolaylık yaşasalar da genel olarak sistem, öğrenci ihtiyaçlarını tatmin edecek seviyede değildir. Buna ek olarak, öğretim üyeleri öğretim sürecini yönlendirme ve rehberlik konusunda kısmen başarılı olmuşlardır. Ancak, dikkat çekici bir sorun olarak, Fen fakültesi öğrencilerinin büyük bir çoğunluğunun (%74) uzaktan eğitimle ders içeriğini etkili bir şekilde öğrenemediği belirlenmiştir. Bu durumun, Fen Fakültesi'nin uygulamalı derslerle yoğun bir şekilde meşgul olmasından kaynaklandığı öne sürülebilir. Uygulamalı dersler, fiziksel etkileşim ve laboratuvar deneyimi gerektirdiğinden, uzaktan eğitim formatında bu deneyimlerin sağlanması oldukça zorlu hale gelmektedir. Uygulamalı derslerin uzaktan eğitimle etkili bir şekilde sunulmaması, öğrencilerin teorik bilgiyi pratik uygulamaya dönüştürme becerilerini geliştirmelerini engelleyebilir. Bu durum, mezuniyet sonrası iş yaşamında gereksinim duyulan becerilerin kazanılmasını ve fen bilimleri alanında başarılı olunmasını olumsuz etkileyebilir.

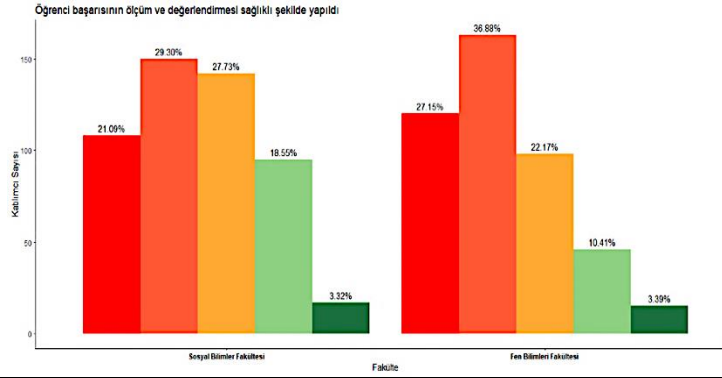
Bu sorunun çözümü için, Fen Fakültesi'nin uzaktan eğitim modelini gözden geçirmesi ve uygulamalı dersler için alternatif çözümler geliştirmesi gerekmektedir. Örneğin, sanal laboratuvarlar veya simülasyonlar gibi dijital araçlar, öğrencilere pratik deneyim kazanma fırsatı sunabilir. Ayrıca, öğretim üyelerinin uzaktan eğitimde daha etkili rehberlik sağlamak için daha fazla destek ve eğitim almaları gerekebilir. Bu şekilde, Fen Fakültesi öğrencilerinin öğrenme deneyimleri daha verimli hale getirilebilir.



Şekil 5. (a) "Öğretim materyalleri yeterli, güncel ve bilgi düzeyi açısından uygundu" (%)  
(b) "Öğretim üyeleri canlı ders konusunda hazırlıklı ve donanımlıydı" (%)

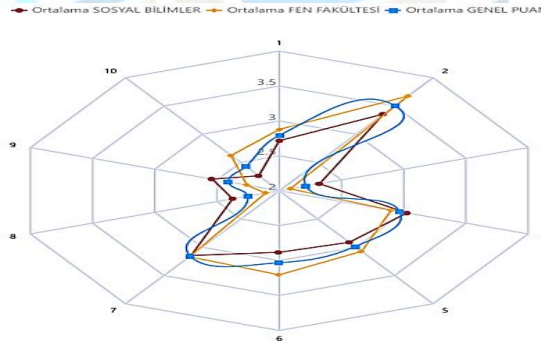
Şekil 5'te Öğretim materyallerinin kısmen yeterli, güncel ve bilgi açısından uygun olduğu gözlemlenmekle birlikte, bu alanda hala eksiklikler bulunduğu göze çarpmaktadır. Özellikle Fen Fakültesi öğrencilerinin canlı ders sisteminden memnuniyet gösterdiği, ancak Sosyal Bilimler Fakültesi öğrencilerinin bu konuda aynı derecede memnun olmadığı belirlenmektedir. Her iki fakültede de öğretim üyelerinin canlı ders konusunda hazırlıklı ve donanımlı olduğu gözlemlenmektedir. Ancak, genel olarak öğrencilerin büyük bir bölümünün aldığı eğitimden memnun olmadığı gözlemlenebilir. Bu durum, eğitim sürecindeki eksikliklerin ve memnuniyetsizliklerin ciddiyetini vurgulamaktadır. Öğrencilerin memnuniyetsizliğinin altında yatan nedenlerin belirlenmesi ve bu konuda iyileştirmeler yapılması gerekmektedir. Bununla birlikte, öğrenci memnuniyetini artırmak ve eğitim kalitesini iyileştirmek için, öğretim materyallerinin daha dikkatli bir şekilde gözden geçirilmesi ve güncellenmesi, öğrencilerin ihtiyaçlarına daha uygun hale getirilmesi gerekmektedir. Ayrıca, öğretim üyelerinin eğitim yöntemleri ve iletişim becerileri konusunda geliştirme ve eğitim programlarına katılma fırsatları sunulması da önemlidir. Bu sayede, öğrencilerin eğitimden daha fazla memnun olmaları ve başarılı olmaları sağlanabilir.





Şekil 6. “Öğrenci Başarısının Ölçüm ve Değerlendirmesi Sağlıklı Şekilde Yapıldı” (%)

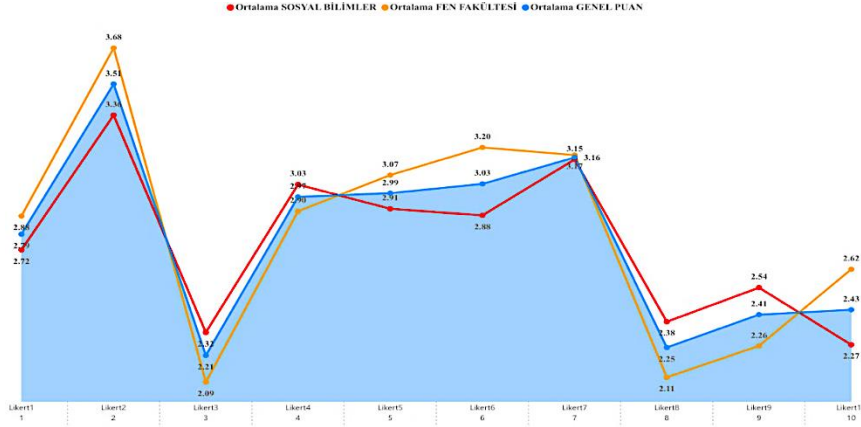
Şekil 6’da Öğretim üyelerinin ders geçme veya ödevler konusunda öğrencilere daha pozitif bir yaklaşım sergilemesinin, derse devam eden ve çalışan öğrenciler arasında hoş olmayan bir rekabet ortamı yarattığı düşünülebilir. Bu durum, öğrenciler arasında haksız bir avantaj sağlanması veya dengesiz bir değerlendirme sürecinin oluşması gibi sonuçlara yol açabilir. Öğrencilerin performanslarının objektif bir şekilde değerlendirilmesi ve adil bir ortam sağlanması önemlidir. Altyapı açısından, özellikle sosyal bilimlerde altyapının güvenilir ve sorunsuz çalıştığını net bir şekilde belirtmek zor olsa da fen fakültesi içinde bazı altyapı sorunlarının olduğu gözlemlenmektedir. Bu sorunlar, öğrencilerin ders materyallerine veya kaynaklara erişimini ve öğrenme deneyimlerini olumsuz yönde etkileyebilir. Toplam 10 soruya dayalı bir değerlendirme yapıldığında, fen fakültesi öğrencilerinin memnuniyet ve memnuniyetsizliklerini daha belirgin bir şekilde dile getirdikleri görülmektedir. Bu durum, fen fakültesi öğrencilerinin eğitim deneyimlerinde daha fazla zorluk yaşadıklarını ve iyileştirme gerektiren alanların daha belirgin olduğunu işaret etmektedir. Bu nedenle, fen fakültesi öğrencilerinin ihtiyaçlarını karşılamak ve eğitim kalitesini artırmak için özel önlemler alınması gerekebilir. Bu önlemler, öğretim yöntemlerinin gözden geçirilmesinden, altyapı iyileştirmelerine kadar geniş bir yelpazeyi kapsamalıdır.



Şekil 7. “Katılımcıların likert ölçeklerine verilen cevaplar dikkate alınarak genel ve özel bazda likert sorularına verilen cevapların genel ağırlıklı ortalaması” (%)

Şekil 7 ve Şekil 8’de likert ölçeklerine verilen cevaplar dikkate alınarak genel ve özel bazda likert sorularına verilen cevapların genel ağırlıklı ortalaması sunulmuştur. Özellikle, L2’de belirtilen gerekli bilgilere (sınav tarihleri, ders kayıtları, ödevler vb.) kolaylıkla erişebildim sorusunda öğrencilerin genel memnuniyetinin en yüksek olduğu gözlemlenmiştir. Ayrıca, L4, L5, L6 ve L7 sorularında da memnuniyetin yeterli düzeyde olduğu görülmektedir. Örnek olarak, aşağıdaki sorulardan bazıları verilebilir: “Ders veren öğretim üyeleri öğretim sürecini yönlendirme ve rehberlik etme konusunda başarılılardı”, “Öğretim materyalleri yeterli, güncel ve bilgi düzeyi açısından uygundu”, “Dersin yönetimi için kullanılan "Canlı Ders Sistemi" (örneğin, ZOOM vb.), öğrenci ihtiyaçlarını karşıladı”, “Dersi veren öğretim üyeleri canlı ders konusunda hazırlıklı ve donanımlıydı”. Bu sorular, öğrencilerin eğitim deneyimleriyle ilgili çeşitli yönleri değerlendirmeyi amaçlamaktadır ve likert ölçeği kullanılarak öğrencilerin bu konulardaki görüşleri belirlenmiştir. Grafiklerdeki genel ağırlıklı ortalamalar,

öğrencilerin genel memnuniyet düzeyini yansıtmaktadır ve öğrencilerin eğitim deneyimlerinden ne kadar memnun olduklarını anlamak için önemli bir araçtır.



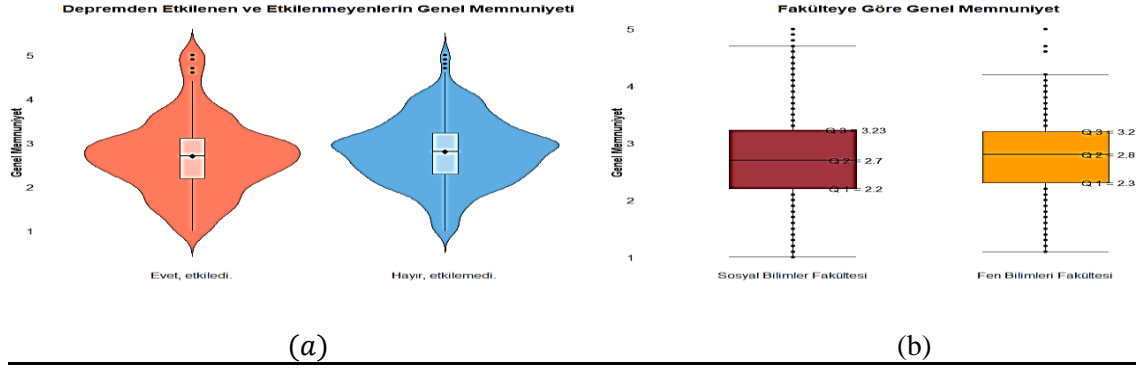
**Şekil 8.** “Katılımcıların likert ölçeklerine verilen cevaplar dikkate alınarak genel ve özel bazda likert sorularına verilen cevapların genel ağırlıklı ortalaması” (%)

Şekil 8’de, Likert3, Likert8, Likert9 ve Likert10 sorularında memnuniyetin düşük olduğu ve genel olarak Fen Fakültesi’nin Sosyal Bilimler Fakültesi’ne göre daha memnuniyetsiz olduğu görülmektedir. Bu sorular aşağıdaki gibidir:

- Ders içeriklerini daha etkili öğrenebildim.
- Aldığım eğitim beklentimi karşıladı.
- Öğrenci başarısının ölçüm ve değerlendirmesi sağlıklı şekilde yapıldı.
- Teknolojik altyapı güvenilir ve sorunsuz çalıştı.

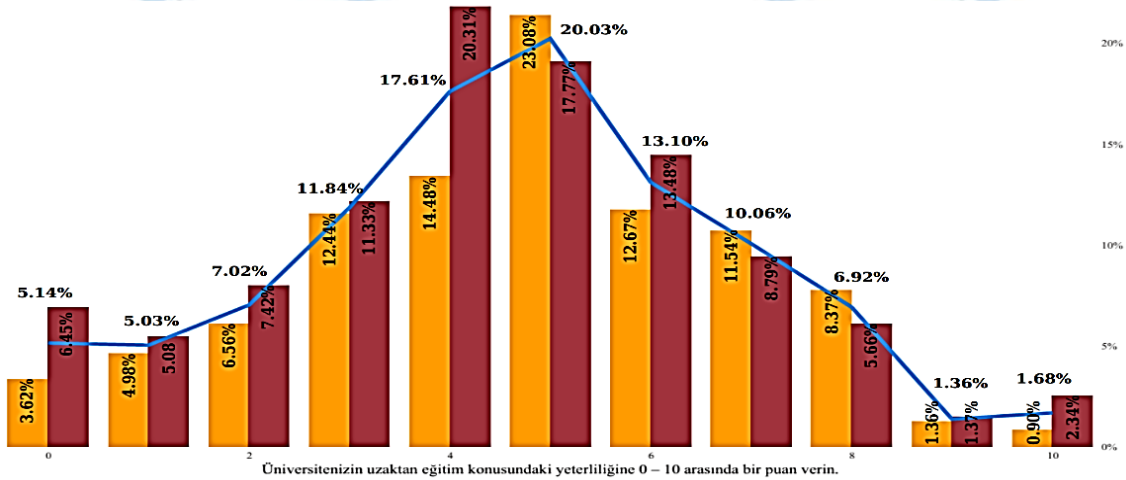
Bu iki grafik arasında en büyük farkın, "Teknolojik altyapı güvenilir ve sorunsuz çalıştı" sorusunda çıktığı gözlemlenmektedir. Fen Fakültesi öğrencileri, Sosyal Bilimler Fakültesi öğrencilerine kıyasla teknolojik altyapının güvenilirliği ve sorunsuz çalışması konusunda daha fazla memnuniyetsizlik yaşamaktadır. Bu durum, Fen Fakültesi’nin uzaktan eğitimde karşılaştığı altyapı sorunlarının daha belirgin olduğunu göstermektedir. Sonuç olarak, Fen Fakültesi’nde özellikle teknolojik altyapı, ders içeriklerinin etkinliği, eğitim beklentilerinin karşılanması ve öğrenci başarısının sağlıklı bir şekilde değerlendirilmesi konularında iyileştirmeler yapılması gerekmektedir. Bu alanlardaki eksikliklerin giderilmesi, öğrenci memnuniyetini artırmada önemli bir adım olacaktır.

Şekil 8 ve Şekil 9’da likert ölçeklerine verilen cevaplar incelendiğinde, Fen Fakültesi öğrencilerinin L2 ("Gerekli bilgilere [sınav tarihleri, ders kayıtları, ödevler vb.] kolaylıkla erişebildim") sorusunda yüksek memnuniyet gösterdiği, buna karşılık L3 ("Ders içeriklerini daha etkili öğrenebildim") sorusunda düşük memnuniyet sergilediği görülmektedir. Bu durum, Fen Fakültesi’nin öğrenci bilgi sisteminin gerekli bilgilere erişim konusunda etkili olduğunu, ancak uzaktan eğitim sürecinde ders içeriklerinin etkili öğrenilmesi konusunda yetersiz kaldığını göstermektedir. Fen Fakültesi’nin uygulamalı derslerinin uzaktan eğitimde yeterince verimli sunulmaması, öğrencilerin teorik bilgiyi pratik uygulamaya dönüştürme süreçlerini olumsuz etkilemektedir. Bu nedenle, uzaktan eğitim modelinin gözden geçirilmesi ve uygulamalı dersler için sanal laboratuvarlar ve simülasyonlar gibi yenilikçi çözümler geliştirilmesi gerekmektedir.



Şekil 9. (a) “Depremden Etkilenen ve Etkilenmeyenlerin Genel Memnuniyeti” (%) (b) “Fakülteye Göre Genel Memnuniyeti” (%)

Şekil 9 (a) ve Şekil 9(b) Depremden etkilenen ve etkilenmeyen öğrencilerin genel memnuniyet düzeyleri arasında belirgin bir fark olmadığı gözlemlenmiştir. Bu durum, depremde etkilenen öğrencilerin, yaşadıkları zorluklara rağmen eğitim sürecinde karşılaştıkları memnuniyet ve memnuniyetsizliklerin depremde etkilenmeyen öğrencilerle benzer düzeyde olduğunu göstermektedir. Bu sonuç, üniversitenin deprem sonrası aldığı önlemler ve sağladığı destek hizmetlerinin, öğrencilerin genel memnuniyet düzeyini korumada etkili olduğunu işaret edebilir. Aynı şekilde, fakülte bazında da memnuniyet düzeyleri arasında anlamlı bir fark olmadığı gözlemlenmiştir. Hem Fen Fakültesi hem de Sosyal Bilimler Fakültesi öğrencilerinin memnuniyet düzeyleri birbirine yakın çıkmıştır. Bu durum, her iki fakültenin de öğrencilere benzer kalitede eğitim ve destek hizmetleri sunduğunu, öğrencilerin beklentilerini karşılamada benzer başarı seviyelerine sahip olduğunu göstermektedir. Bu bulgular, deprem gibi büyük ölçekli bir afetin, eğitim sürecinde öğrenci memnuniyeti üzerinde doğrudan ve belirgin bir etkisi olmadığını, üniversitenin bu tür kriz durumlarında etkin bir şekilde müdahale edebildiğini ortaya koymaktadır. Deprem sonrası alınan önlemler, öğrenci desteği, öğretim üyelerinin esnek ve duyarlı yaklaşımları, teknolojik altyapının hızlı bir şekilde yeniden düzenlenmesi ve gerekli psikolojik destek hizmetlerinin sağlanması, öğrencilerin genel memnuniyet düzeylerinin korunmasında önemli rol oynamış olabilir. Bununla birlikte, her iki fakültedeki memnuniyet düzeylerinin benzer olması, fakülteler arasındaki yönetim ve öğretim kalitesinin tutarlılığını göstermektedir. Öğrencilerin aldıkları hizmetler ve eğitim kalitesine dair benzer geri bildirimlerde bulunmaları, üniversitenin farklı fakülteler arasında adil ve eşit bir eğitim ortamı sunduğunu doğrulamaktadır. Sonuç olarak, depremde etkilenme durumuna ve fakülte bazına göre öğrenci memnuniyet düzeylerinde belirgin bir farkın olmaması, üniversitenin kriz yönetimi ve eğitimde sürekliliği sağlama konularında başarılı olduğunu göstermektedir. Bu başarı, üniversitenin öğrencilere sağladığı destek hizmetlerinin ve eğitim kalitesinin kriz dönemlerinde bile korunabildiğinin bir göstergesidir.



Şekil 10. “Üniversitenizin Uzaktan Eğitim Konusundaki Yeterliliğine 0-10 Arasında Bir Puan verin” (%)



Bu çalışmada, saha araştırmasının en önemli sorularından biri olan pandemi döneminde uygulanan uzaktan eğitim sistemine dair öğrencilerin değerlendirmelerini almak için, öğrencilere uzaktan eğitim sistemine 0 ile 10 arasında bir puan vermeleri istendi. Elde edilen veriler, Fen Fakültesi ve Sosyal Bilimler Fakültesi öğrencilerinin uzaktan eğitim deneyimleri ve memnuniyet düzeyleri hakkında önemli bilgiler sunmaktadır.

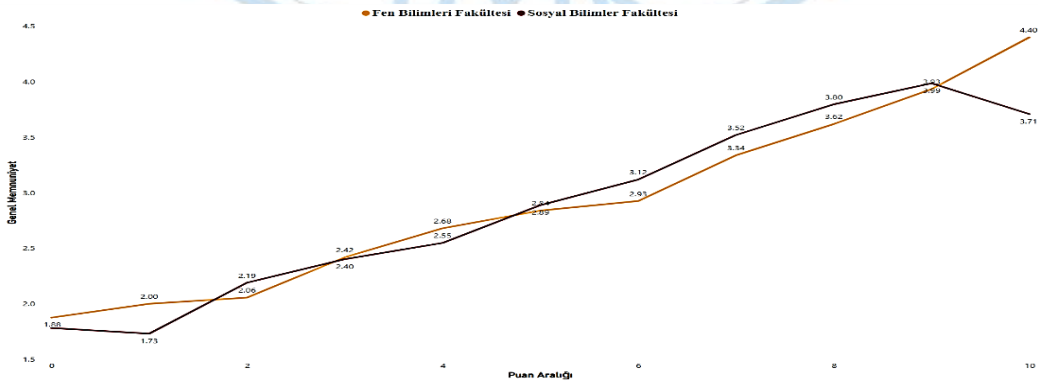
Fen Fakültesi öğrencilerinin verdikleri puanların genellikle 5 puan etrafında toplandığı gözlemlenmiştir. Bu, Fen Fakültesi öğrencilerinin uzaktan eğitim sistemine karşı ortalama düzeyde bir memnuniyete sahip olduklarını göstermektedir. Bu sonuç, uzaktan eğitim sürecinde öğrencilerin karşılaştığı zorluklar ve bu sürecin sağladığı avantajların dengede olduğunu düşündürülebilir. Fen Fakültesi'nin doğası gereği, uygulamalı ve laboratuvar ağırlıklı derslerin uzaktan eğitimde yeterince etkili sunulmaması, öğrencilerin memnuniyetini olumsuz yönde etkileyen önemli bir faktör olabilir.

Sosyal Bilimler Fakültesi öğrencilerinin verdikleri puanların ise genellikle 4 puan civarında yoğunlaştığı görülmüştür. Bu, Sosyal Bilimler Fakültesi öğrencilerinin uzaktan eğitim sistemine karşı daha düşük bir memnuniyete sahip olduğunu göstermektedir. Bu sonuç, sosyal bilimler öğrencilerinin uzaktan eğitim sürecinde yaşadıkları altyapı sorunları ve canlı ders için kullanılan araçların yetersizliğinden kaynaklanabilir. Öğrencilerin, uzaktan eğitim araçlarının ve platformlarının ihtiyaçlarını karşılamakta yetersiz kaldığını belirtmeleri, puanların düşük olmasının bir nedeni olarak değerlendirilebilir.

Genel eğilimde, ortalama puanın 5 olduğu belirtilmiştir. Bu, genel olarak öğrencilerin uzaktan eğitim sistemine karşı ortalama bir memnuniyet düzeyine sahip olduğunu göstermektedir. Ancak, fakülteler arasındaki farklılıklar dikkat çekicidir. Fen Fakültesi öğrencileri puanlama yaparken daha katı davranma eğilimindeyken, Sosyal Bilimler Fakültesi öğrencilerinin daha esnek davrandığı gözlemlenmiştir. Sosyal Bilimler Fakültesi'nde hem 0 hem de 10 puanına verilen cevapların kuyruklardaki yüzdelerinin daha fazla olması, bu fakültenin öğrencilerinin uzaktan eğitim deneyimlerini daha uç noktalarda değerlendirdiğini göstermektedir. Bu bulgular, pandemi döneminde uygulanan uzaktan eğitim sisteminin farklı fakülteler arasında farklı şekillerde algılandığını ve değerlendirildiğini göstermektedir.

Fen Fakültesi öğrencileri, uzaktan eğitimde karşılaştıkları zorluklar ve özellikle uygulamalı derslerde yaşadıkları sıkıntılar nedeniyle daha düşük puanlar verirken, Sosyal Bilimler Fakültesi öğrencileri ise altyapı sorunları ve kullanılan araçların yetersizliği nedeniyle memnuniyetsizliklerini dile getirmişlerdir.

Sonuç olarak, uzaktan eğitim sisteminin iyileştirilmesi ve öğrenci memnuniyetinin artırılması için fakültelerin özel ihtiyaçlarına ve beklentilerine odaklanmak gerekmektedir. Fen Fakültesi için, uygulamalı derslerin daha etkili bir şekilde sunulmasını sağlayacak sanal laboratuvarlar ve simülasyonlar gibi yenilikçi çözümler geliştirilebilir. Sosyal Bilimler Fakültesi için ise, altyapının güçlendirilmesi ve daha etkin canlı ders platformlarının kullanılması öğrencilerin memnuniyetini artırabilir. Bu şekilde, uzaktan eğitim sisteminin genel kalitesi ve öğrenci memnuniyeti artırılabilir.



Şekil 11. “Üniversitenizin Uzaktan Eğitim Konusundaki Yeterliliğine 0-10 Arasında Bir Puan Ağırlığı” (%)

Çalışmada, uzaktan eğitim sisteminin yeterliliğini ölçen puan sorusu ile likert sorularının ağırlıklı ortalamasından elde edilen genel memnuniyet karşılaştırıldığında, genel olarak memnuniyet arttıkça puan düzeyinin de arttığı gözlemlenmiştir. Ancak, sosyal bilimler öğrencilerinde sonlara doğru bu eğilimin tersine döndüğü ve memnuniyet düşükken bile daha yüksek puanlar verildiği dikkat çekmektedir. Bu durum, sosyal bilimler öğrencilerinin değerlendirmelerinde daha geniş bir yelpazeye sahip olabileceğini ve belki de bazı faktörlerin değerlendirmelerini etkilediğini göstermektedir.

#### 4. TARTIŞMA VE ÖNERİLER

Bu çalışma, pandemi döneminde üniversitelerin uyguladığı uzaktan eğitim sistemlerinin öğrenci memnuniyeti üzerindeki etkilerini ve bu memnuniyetin fakülte bazında ve depresyon etkisine göre nasıl değiştiğini incelemektedir. Elde edilen bulgular, uzaktan eğitim sürecinin teknolojik altyapısı, eğitim materyalleri, öğretim üyelerinin hazırlığı ve kriz yönetimi gibi çeşitli faktörlerle nasıl ilişkilendiğini göstermektedir.

Öğrencilerin genel memnuniyet düzeyleri incelendiğinde, "Gerekli bilgilere (sınav tarihleri, ders kayıtları, ödevler vb.) kolaylıkla erişebildim" gibi konularda genellikle yüksek memnuniyet olduğu tespit edilmiştir. Ancak, uzaktan eğitim sürecinde ders içeriklerinin etkinliği, eğitim beklentilerinin karşılanması, öğrenci başarısının ölçülmesi ve teknolojik altyapının güvenilirliği gibi alanlarda memnuniyet düzeyleri düşüktür. Özellikle, Fen Fakültesi öğrencileri, uygulamalı derslerin uzaktan etkili bir şekilde sunulmaması konusunda daha fazla endişe taşımaktadır. Sosyal Bilimler Fakültesi öğrencileri ise altyapı sorunları ve canlı ders araçlarının yetersizliği nedeniyle genel olarak daha düşük memnuniyet göstermektedir. Çalışmada, depresyondan etkilenen ve etkilenmeyen öğrenciler arasında genel memnuniyet düzeyleri arasında anlamlı bir fark bulunmamıştır. Bu durum, üniversitenin depresyon sonrası aldığı önlemler ve sağladığı destek hizmetlerinin etkin olduğunu göstermektedir. Kriz yönetimi süreçlerinin öğrenci memnuniyetini korumada ne kadar önemli olduğunu vurgulayan bu bulgu, üniversitenin kriz dönemlerindeki sağlam yönetimini ortaya koymaktadır.

Bu bulgular, uzaktan eğitimde kaliteyi artırmak için öğretim elemanlarına yönelik eğitim ve destek mekanizmalarının güçlendirilmesi gerektiğini göstermektedir. Ayrıca, uzaktan eğitimin kalitesinin artırılmasına yönelik stratejiler geliştirilmesi ve bu stratejilerin öğrenci memnuniyetini ve öğrenme sonuçlarını iyileştirecek şekilde tasarlanması gerektiği anlaşılmaktadır. Eğitim materyallerinin çeşitlendirilmesi, teknolojik altyapının güçlendirilmesi ve öğrencilere sağlanan destek hizmetlerinin artırılması, bu stratejilerin önemli bileşenleri olmalıdır. Böylece, uzaktan eğitim sürecinin etkinliği artırılabilir ve öğrencilerin eğitim kalitesi konusundaki endişeleri giderilebilir.

Teknolojik altyapının güçlendirilmesi: Fen Fakültesi öğrencilerinin teknolojik altyapıyla ilgili memnuniyetsizliklerini gidermek için, üniversitenin internet altyapısını ve teknik destek kapasitesini artırmalıdır. Bu, uzaktan eğitim sürecinde yaşanan kesinti ve aksaklıkları en aza indirecektir. Uygulamalı dersler için yenilikçi çözümler: Fen Fakültesi için sanal laboratuvarlar ve simülasyonlar gibi yenilikçi çözümler geliştirilmeli ve uygulamalı derslerin etkili bir şekilde sunulması sağlanmalıdır. Bu, öğrencilerin teorik bilgiyi pratik uygulamaya dönüştürme süreçlerini destekleyecektir. Eğitim materyallerinin çeşitlendirilmesi ve güncellenmesi: Öğretim materyallerinin çeşitlendirilmesi ve güncellenmesi, öğrencilerin farklı öğrenme stillerine hitap etmelerini sağlayacaktır. Video dersler, interaktif içerikler ve çeşitli eğitim kaynakları kullanılarak bu çeşitlilik artırılabilir. Öğretim üyelerinin eğitimi ve desteklenmesi: Öğretim üyeleri, uzaktan eğitimde etkin olabilmek için düzenli eğitimler almalı ve canlı ders araçları konusunda rehberlik edilmelidir. Bu, öğrencilere daha iyi bir eğitim deneyimi sunmalarını sağlayacaktır. Öğrenci geri bildirimlerinin sürekli değerlendirilmesi: Öğrenci memnuniyetini sürekli olarak izlemek ve geri bildirimlere dayalı olarak iyileştirmeler yapmak önemlidir. Anketler aracılığıyla elde edilen veriler, hızlı çözümler üretilmesine ve öğrenci beklentilerinin karşılanmasına yardımcı olacaktır. Kriz yönetimi ve destek hizmetlerinin güçlendirilmesi: Üniversitenin kriz dönemlerinde öğrencilere sağladığı destek hizmetlerinin etkinliğini korumak için süreçler gözden geçirilmeli ve güncellenmelidir. Psikolojik destek, teknik yardım ve esnek ders programları gibi hizmetler, öğrencilerin memnuniyetini artırmada kritik öneme sahiptir.

Bu öneriler, üniversitenin uzaktan eğitim sürecinde karşılaştığı zorlukları aşmasına ve öğrenci memnuniyetini artırmasına yardımcı olacaktır. Öğrencilerin eğitim deneyimlerini iyileştirmek, uzun vadede üniversitenin akademik başarısını ve itibarını olumlu yönde etkileyecektir. Bu sorundan elde

edilen bilgiler ışığında, öğrencilerin uzaktan eğitim sistemine uyum sorunu yaşayabileceği ya da fakültelerin pandemi dönemine göre herhangi bir iyileştirme ve geliştirme yapmamış olabileceği anlaşılmaktadır.

## 5. KAYNAKÇA

- Çetin, S., & Akduman, D. (2022). Covid-19 pandemi dönemi uzaktan eğitim sürecine ilişkin öğretmen ve öğrenci görüşleri. Ankara University Journal of Faculty of Educational Sciences (JFES), 55(1), 119-146.
- Erzen, E., & Ceylan, M. (2020). COVID-19 salgını ve uzaktan eğitim: uygulamadaki sorunlar. EKEV Akademi Dergisi, 84, 229-248.
- Few, S. (2006). Information Dashboard Design: The Effective Visual Communication of Data. Analytics Press.
- Fıratlı Türker, E. (2023). 6 Şubat 2023 depremleri sonrasında zorunlu uzaktan eğitime geçiş nedenlerine göre üniversite öğrencilerinin uzaktan eğitim algılarının farklılaşmasının incelenmesi. Avrasya Sosyal ve Ekonomi Araştırmaları Dergisi, 10(3), 271-300.
- Kırmızıgül, H. G. (2020). COVID-19 salgını ve beraberinde getirdiği eğitim süreci. Avrasya Sosyal ve Ekonomi Araştırmaları Dergisi, 7(5), 283-289.
- Mete, H., Erdem, A., Uzal, G., Kılıç, E. (2024). Meslek yüksekokullarındaki uzaktan eğitimin öğrenci ve öğretim elemanları açısından değerlendirilmesi. Türkiye Mesleki ve Sosyal Bilimler Dergisi, 5(13), 44-60.
- Özkaya, Y., Duran, A., & Demirci, K. (2023). Çevrimiçi eğitim uygulamasının İİBF öğretim üyeleri üzerine etkileri. Yönetim Bilimleri Dergisi, 21(Cumhuriyetin 100. Yılı Özel Sayısı), 676-709. <https://doi.org/10.35408/comuybd.1344055>
- Tufte, E. R. (2001). The Visual Display of Quantitative Information.
- Türk Eğitim Vakfı. (2024). Uzaktan eğitimin tarihsel gelişimi. Vikipedi. Erişim adresi: [https://tr.wikipedia.org/wiki/uzaktan\\_e%C4%9Fitimin\\_tarihsel\\_geli%C5%9Fimi](https://tr.wikipedia.org/wiki/uzaktan_e%C4%9Fitimin_tarihsel_geli%C5%9Fimi)

## 6. EKLER

### Ek-1 TABLO

Çalışmada yer alan likert sorular

L1	<i>öğrenci bilgi sistemi öğrenci ihtiyaçlarımı karşıladı.</i>
L2	<i>gerekli bilgilere(Sınav tarihleri, ders kayıtları, ödevler vb.) kolaylıkla erişebildim.</i>
L3	<i>ders içeriklerini daha etkili öğrenebildim.</i>
L4	<i>ders veren öğretim üyeleri öğretim sürecini yönlendirme ve rehberlik etme konusunda başarılılardı.</i>
L5	<i>öğretim materyalleri yeterli, güncel ve bilgi düzeyi açısından uygundu.</i>
L6	<i>dersin yönetimi için kullanılan "Canlı Ders Sistemi"(ZOOM vb.) öğrenci ihtiyaçlarını karşıladı.</i>
L7	<i>dersi veren öğretim üyeleri canlı ders konusunda hazırlıklı ve donanımlılardı.</i>
L8	<i>aldığım eğitim beklentimi karşıladı.</i>
L9	<i>öğrenci başarısının ölçüm ve değerlendirmesi sağlıklı şekilde yapıldı.</i>
L10	<i>teknolojik altyapı güvenilir ve sorunsuz çalıştı.</i>



**Assessing Online and Face-to-Face Education in Higher Education: The Experience  
with Education Systems Inventory**

**E. Serra Yurtkoru<sup>1</sup>, Rengin Eda Sert<sup>2\*</sup>, Mehmet Dinç<sup>3</sup>**

<sup>1</sup>Marmara University, Faculty of Business Administration, Business Administration Department,  
34722, Istanbul, Türkiye

\*Corresponding author e-mail: syurtkoru@marmara.edu.tr

**Abstract**

*Higher education has undergone a profound transformation with increased technological improvement and the global COVID-19 pandemic. This shift has prompted a rapid transition from traditional face-to-face instruction to online learning modalities, starting a critical examination of the effectiveness and impact of these educational approaches and different teaching methods.*

*Online education, once considered an alternative or complementary method to traditional face-to-face instruction, has gained significant power due to its flexibility, accessibility, and the relentless advancement of digital technologies. Conversely, face-to-face education, deeply rooted in centuries of academic tradition, provides a rich, interactive learning environment facilitated by direct human interaction.*

*Hence, this study aims to measure and compare online and face-to-face education through the lens of higher education students who have experienced both methods. A 32-item questionnaire is designed to explore various dimensions of the educational experience and overall effectiveness and can be used to explain academic achievement and satisfaction in both settings. The data collection process targeted higher education students with experience in both online and face-to-face education.*

*Structural Equation Modeling (SEM) is employed to data collected (n=300) and the validity and reliability of the scale is assessed. Preliminary findings suggest that the scale can be applied in both online and face-to-face education settings based on good fit values. The detailed assessment of measurement weights, structural covariances, and measurement residuals will help understand the inventory further.*

*This study aims to provide valuable insights into the relative advantages and disadvantages of each modality in the higher education context by offering The Experience with Education Systems Inventory. Through this, we hope to provide educators and policymakers clearer understanding of how to navigate and optimize the educational experience in the rapidly evolving landscape of higher education.*

**Keywords:** *Structural Equation Modeling, Validity, Reliability; Online Education, Face-to-Face Education*

**INTRODUCTION**

As a result of the advancement of technology and the wide usage of the Internet, the education model that brings together stakeholders of the education in virtual learning platforms independent of physical space and time is defined as an online education model (AI & Madran, 2004). The online education model, which has developed and become widespread with the emergence of the World Wide Web (www), is seen to be preferred especially in higher education institutions worldwide compared to face-to-face education model due to its feature of providing flexibility to instructors and students (Sun & Chen, 2016).

In parallel with the fast advancement of technology, the emergence of COVID-19, has made the

online education model a necessity rather than a preference in the fight against the pandemic. During the COVID-19 pandemic, the transition to the online education setting as a mandatory measure globally has led to the communication and interaction between the components of the education model becoming dependent on technological tools (Simonson et al. 2019). The inclusion of technology in the education process provides richness and flexibility, such as offering mass education opportunities, eliminating geographical distances, and minimizing time costs (Pregowska et al. 2021).

The success of the online education model is possible through adapting to technological change, engaging in activities to improve the quality of learning, and achieving goals related to imparting necessary competencies to students (Özkul & Girginer, 2001). In this context, the effective use of communication technologies is crucial for increasing interaction among stakeholders involved in the educational process, making the success of the online education model critical (Tanhan & Özok, 2020).

When academic studies on the comparison of online education and face-to-face education are examined, the dimensions generally used are Student Achievement (Bernard et al. 2004), Interaction and Participation (Dziuban et al. 2004), Learning Experience and Satisfaction (Swan, 2003), Accessibility and Flexibility (Means et al. 2009), Technological Infrastructure and Support (Anderson, 2008), Cost (Tucker, 2012), Teaching Methods (Means et al. 2014), Self-regulation and Motivation (Zimmerman, 2002). Based on these dimensions, in this study, the dimensions of Learning Competence, Enjoyment, Socialization and Friendship, Educational Tools & Materials, Assessment, Instructors' Competency, Communication are used to compare educational models from the perspective of academic achievement and satisfaction with both online and face-to-face education experienced by higher education students.

## **MATERIAL AND METHODS**

### **Material**

In this study, a multi-item questionnaire was developed and tested. The purpose of the inventory was to explore various dimensions of educational experience and overall effectiveness. First, a literature search was conducted to examine studies similar to this concept. Later a group of 30 higher education students were chosen from the Marmara University Faculty of Business Administration to perform a focus group study. All students had experience with online and face-to-face education settings and shared their opinions regarding the systems.

Based on the literature survey and feedback from the students an eight dimension, 32-item Experience with Education Systems Inventory (EESI) was developed. The items were measured on a five-point interval scale where “totally disagree” equals 1 and “totally agree” equals 5.

### **Methods**

#### *The Collection of the Data*

Data for this study were collected from business administration students of a public university in Türkiye. The questionnaire was created using LimeSurvey and was distributed to students by sharing the link via e-mail.

The inventory was designed to assess both online and face-to-face education, hence the respondents were asked to answer the same items to evaluate first online and then to evaluate the face-to-face education systems. 311 students responded voluntarily, and 300 of the collected questionnaires were usable.

The sample consisted of 138 females (46 %) and 162 males (54%). The class distribution of the sample was 170 seniors (57%), 77 juniors (26%), and 53 sophomores (18%).

The respondents' mode of education preference were 120 face-to-face education (40%), 68 online education (23%), and hybrid 112 (37%).

*Statistical Analysis*

To assess the reliability and validity of the inventory, Structural Equation Modeling's (SEM) Confirmatory Factor Analysis (CFA) technique was employed. Since the purpose of the study was to develop an inventory to compare different education systems in the primary stage the CFAs were conducted for online and face-to-face education systems as separate groups. In the secondary stage invariance test was employed.

**RESULTS**

*Primary Stage – Separate Confirmatory Factor Analyses*

To test and validate the factors proposed by the Experience with Education Systems Inventory (EESI) and investigate the dimension structure more deeply, confirmatory factor analyses (CFA) were conducted using IBM SPSS AMOS 25.0 program.

The results for the face-to-face education system can be found in Table 1. The goodness of fit indexes indicated the model was fit and modification indices did not indicate any further improvement in the model, however the correlation between two communication factors, 'communication within the classroom' and 'communication outside the classroom' was almost one, indicating one factor model instead of two. Therefore, a second model was tested with seven factors. When the estimated parameters were analyzed, it was seen that even though loadings were all significant at .01 level, factor loadings of three items were less than .5, which were rather low (Netemeyer, Bearden, & Sharma 2003). Hence, the model was retested excluding these items.

**Table 1.** CFA result for face-to-face education system

Model	Dimension	Item #	$\chi^2(df)$	$\chi^2/df$	CFI	TLI	SRMR	RMSEA
1	8	32	980.99(436)	2.25	.91	.89	.05	.07
2	7	32	987.35(443)	2.23	.91	.90	.52	.06
3	7	29	800.94(356)	2.25	.92	.90	.05	.06

Likewise, the CFA test of online education system indicated seven factor model due to high correlation between 'communication within the classroom' and 'communication outside the classroom'. Similar to face-to-face education system one item from each of 'materials', 'assessment', and 'instructors' competence' dimensions were trimmed as their loadings were less than .5 (See Table 2).

**Table 2.** CFA result for online education system

Model	Dimension	Item #	$\chi^2(df)$	$\chi^2/df$	CFI	TLI	SRMR	RMSEA
1	8	32	1056.62(436)	2.42	.86	.84	.07	.07
2	7	32	1076.03(443)	2.43	.86	.84	.07	.07
3	7	29	760.60(356)	2.14	.90	.89	.06	.06

Model 3 CFA results showed that all factor loadings are relatively high and remarkable supplying evidence for convergent validity (Bagozzi & Yi, 1988) in both face-to-face and online education. Construct reliabilities of scales, indicated high internal consistency of the dimensions (Hair, Black, Babin, & Anderson, 2010; Netemeyer, Bearden, & Sharma, 2003). Only 'assessment' dimension in online education system had rather low (.60) construct reliability, considering this dimension has three items and the construct reliability value for the same factor in the face-to-face system data set was high (.73) it still included in the inventory for further analyses (See Table 3).



**Table 3.** Construct reliabilities and extracted average variances

Construct	Item #	Face-to-face		Online	
		CR	AVE	CR	AVE
Learning competence	4	.84	.57	.83	.56
Enjoyment	4	.83	.54	.81	.53
Socialization and friendship	4	.87	.62	.77	.47
Educational tools & materials	3	.79	.56	.69	.43
Assessment	3	.73	.48	.60	.33
Instructors' competency	3	.81	.58	.79	.56
Communication	8	.89	.51	.87	.46

CR= Construct Reliability; AVE=Average variance extracted

Average variance extracted (AVE) reflects the overall amount of variance accounted for by the latent construct. Fornell and Larcker (1981) favor a level of .50 or above, but for new scales values more than .45 seem reasonable (Netemeyer, Bearden & Sharma, 2003). As can be seen from Table 3, AVE values for the online education system data set have relatively lower results especially 'assessment' is quite problematic. Bearing in mind during the online education system, assessment of the courses was mostly online tests, this dimension requires more elaboration in the future.

To assess the discriminant validity of the scales we first checked the Fornell and Larcker (1981) criterion, where the discriminant validity is established when the AVE for the two constructs is greater than the squared correlation between the two constructs. Since the AVE values of some of the constructs were rather low some of the calculations did not satisfy the expected Fornell and Larcker criterion. Then we constrained parameter estimate for the two constructs to unity and compared with factor model where parameter is freely estimated (Anderson & Gerbing, 1988). Even with the problematic constructs when each pair the constrained CFA produced an increase in the chi-square statistic ( $\Delta\chi^2$  with 1 *df*) that was significant at  $p < .01$ . Findings supported both the convergent and discriminant validity consequently the distinctness of the constructs. Hence, findings of reliability, convergent validity, and discriminant validity satisfied psychometric property requirements for both data sets.

#### *Secondary Stage – Invariance Analysis*

After each sample was tested separately for the two education systems, and good fit values were achieved, a multigroup invariance test was applied as well to analyze the equivalence of measurements further. Testing the newly developed inventory for different teaching environments does not guarantee the equivalence of the item measurements and underlying component structure across groups; these hypotheses must be tested statistically.

In invariance analysis, equality constraints are imposed on particular parameters and thus the data for all groups must be analyzed simultaneously to obtain efficient estimates. Then its  $\chi^2$  value is compared with that of the initial model in which no equality constraints were imposed. The difference in  $\chi^2$  values is distributed as  $\chi^2$  with degrees of freedom equal to the difference in degrees of freedom. When the  $\Delta\chi^2$  is not statistically significant, equality across the groups does hold (Byrne 2001).

**Table 4.** Means, standard deviations, Cronbach's alphas and correlations of face-to-face (left – lower corner) and online (right – upper corner) samples

Model Description	$\chi^2(df)$	$\Delta\chi^2(\Delta df)$	<i>p</i>	CFI	$\Delta CFI$	TLI	SRMR	RMSEA	Decision
Configural Invariance (Unconstraint Model)	1561.53(712)	-		.91	-	.90	.05	.05	
Metric Invariance (All Factor Loadings Constraint Equal)	1585.68(734)	24.15(22)	.34	.91	.00	.90	.05	.04	Accept Invariance
Factor Variance Covariance Invariance	1625.17(762)	39.49(28)	.07	.91	.00	.90	.06	.04	Accept Invariance
Error Variance Invariance (Measurement Residuals)	1827.87(791)	202.70(29)	.00	.89	-.02	.89	.07	.05	Reject Invariance

Another method for invariance is using  $\Delta CFI$  Where the recommended cut-off criterion is  $\Delta CFI = .01$ . (Cheung & Rensvold, 2002). The  $\Delta CFI$  finding ( $\Delta CFI = .001$ ), together with the values of the fit indices indicating fit of the model supported metric invariance. Likewise, when we tested invariance of covariance variance, where again invariance was supported,  $\Delta CFI = .001 < .01$ . Only the equality of error variances equivalence was not achieved in both  $\Delta\chi^2$  and  $\Delta CFI$  methods, however it is widely accepted that testing for measurement residuals invariance is too overly restrictive.

As can be seen from Table 4 we achieved metric invariance, which satisfies the minimum requirement to say the scales we used in this study, yield equivalent representation among the two education systems. We also achieved factor covariance invariance, which indicates constructs are related to each other similarly across groups. Hence, we can accept that we reached invariance for our measurement scales and that constructs are perceived in a similar manner for both face-to-face and online system.

**Table 5.** Means, standard deviations, Cronbach's alphas and correlations of face-to-face (left – lower corner) and online (right – upper corner) samples

	Face-to-face		Online		<i>t</i>	<i>p</i>	1	2	3	4	5	6	7
	M	SD	M	SD									
1	3.33	.96	2.84	.98	7.04	.00	-	.74**	.56**	.59**	.53**	.50**	.57**
2	3.38	.97	2.87	1.05	6.33	.00	.74**	-	.59**	.66**	.55**	.53**	.62**
3	3.71	1.08	3.07	1.04	8.15	.00	.53**	.57**	-	.78**	.68**	.65**	.73**
4	3.55	1.05	3.20	1.03	4.79	.00	.52**	.62**	.65**	-	.71**	.66**	.78**
5	3.56	.97	3.09	.97	7.05	.00	.45**	.47**	.56**	.56**	-	.69**	.77**
6	3.56	.99	3.21	1.03	5.08	.00	.46**	.49**	.50**	.61**	.60**	-	.79**
7	3.45	.88	3.14	.91	4.93	.00	.50**	.57**	.64**	.68**	.63**	.69**	-

Note. 1. Learning competence, 2. Enjoyment, 3. Socialization and friendship, 4. Educational tools and materials, 5. Assessment, 6. Instructors' competency, 7. Communication  
 \*  $p \leq .05$ , \*\*  $p \leq .01$ , \*\*\*  $p \leq .001$

Means standard deviations and correlations are provided in Table 5. Correlations were all positive and significant and their magnitudes were moderate to high. The higher correlation coefficients were on the online education data set. When the means are compared between face-to-face and online education systems, it is seen that all variables were significantly different, and for all variables, mean values were higher in face-to-face education system.

## DISCUSSION AND CONCLUSION

The results of this study indicate that the Experience with Education Systems Inventory (EESI) is a valid and reliable tool for assessing and comparing the effectiveness of online and face-to-face settings in the higher education.

The confirmatory factor analysis (CFA) for both education settings provided good model fits, confirming the inventory is applicable across different teaching modalities. The constructs of learning competence, enjoyment, socialization and friendship, educational tools and materials, assessment, instructors' competency and communication were all validated.

The findings revealed significant differences in students' who experienced both settings perceptions of the two education systems. Face-to-face education scored higher on all measured variables compared to online education setting, suggesting that students find the traditional face-to-face education more effective.

However, these findings were interesting when student mode of delivery preference is considered as only 40% rest were either online or hybrid. Despite lower scores in some areas, online education provides accessibility and flexibility which are crucial in today's digital world.

The lower construct reliability in the assessment dimension for the online education setting suggest that this area requires further study. Assessment strategies in online education may be improved with innovative assessment methods to ensure comprehensive and accurate evaluation of students' performance.

The data for the study was collected from business administration students who experienced both online and face-to-face education settings as mentioned, the inventory should be applied to other students from different areas those have different methods or those are more dependent on laboratories or other physical environments or equipments to generalization of the Experience with Education Systems Inventory (EESI).

## References

- Al, U., & Madran, O. (2004). Web tabanlı uzaktan eğitim sistemleri: Sahip olması gereken özellikler ve standartlar. [Web-Based Distance Education Systems: Required Features and Standards]. *Bilgi Dünyası*, 5(2), 259-271.
- Anderson, J. C. & Gerbing, D.W. (1988). Structural equation modeling in practice: A Review and Recommended Two-Step Approach. *Psychological Bulletin* 103(May): 411-423
- Anderson, T. (Ed.). (2008). *The theory and practice of online learning*. Athabasca University Press.
- Bagozzi R.P. & Yi, Y. (1988). On the evaluation of structural equation models, *Journal of the Academy of Marketing Science*, 16(1), 74-94.
- Bernard, R. M., Abrami, P. C., Lou, Y., Borokhovski, E., Wade, A., Wozney, L., Wallet, P. A., Fiset, M., & Huang, B. (2004). How does distance education compare with classroom instruction? A meta-analysis of the empirical literature. *Review of educational research*, 74(3), 379-439.
- Byrne, B.M. (2001). *Structural Equation Modeling with AMOS: Basic Concepts, Applications, and Programming*. New Jersey: Lawrence Erlbaum Associates, Inc.
- Cheung, G.W, & Rensvold, R.B. (2002). Evaluating goodness-of-fit indexes for testing measurement invariance, *Structural Equation Modeling*, 9(2), 233–255.
- Dziuban, C., Hartman, J., & Moskal, P. (2004). *Blended learning*, Educause Centre for Applied Research Bulletin. ECAR Boulder, CO
- Fornell, C. & Larcker F. D. (1981). Evaluating Structural Equation Models with Unobservable Variables and Measurement Error. *Journal of Marketing Research* 18(February): 39-50
- Hair Jr. F. J., Black C. W., Babin J. B., & Anderson E. R. (2010). *Multivariate Data Analysis. A global perspective 7th Ed.*, Upper Saddle River, NJ: Prentice Hall Inc.
- Means, B., Bakia, M., & Murphy, R. (2014). *Learning online: What research tells us about whether, when and how*. Routledge.
- Means, B., Toyama, Y., Murphy, R., Bakia, M., & Jones, K. (2009). Evaluation of evidence-based practices in online learning: A meta-analysis and review of online learning studies.
- Netemeyer, R., G. Bearden, W. O. & Sharma, S. (2003). *Scaling Procedures: Issues and Applications*. Thousand Oaks, CA: Sage Publication
- Özkul, A. E., & Girginer, N. (2001). Uzaktan eğitimde teknoloji ve etkinlik. [Technology and effectiveness in distance education] *Sakarya Üniversitesi Eğitim Fakültesi Dergisi*, (3)
- .Pregowska, A., Masztalerz, K., Garlińska, M., & Osial, M. (2021). A worldwide journey through



**V. INTERNATIONAL APPLIED STATISTICS CONGRESS (UYIK - 2024)**  
**İstanbul / Türkiye, May 21-23, 2024**

---

- distance education—from the post office to virtual, augmented and mixed realities, and education during the COVID-19 pandemic. *Education Sciences*, 11(3), 118.
- Simonson, M., Zvacek, S. M., & Smaldino, S. (2019). *Teaching and learning at a distance: Foundations of distance education* 7th edition.
- Sun, A., & Chen, X. (2016). Online education and its effective practice: A research review. *Journal of information technology education: Research*, 15.
- Swan, K. (2003). Learning effectiveness online: What the research tells us. *Elements of quality online education, practice and direction*, 4(1), 13-47.
- Tanhan, F., & Özok, Ö. Ü. H. İ. (2020). *Pandemi ve eğitim*. [Pandemic and Education]. Ankara: Anı Yayıncılık.
- Tucker, B. (2012). The flipped classroom. *Education next*, 12(1), 82-83.
- Zimmerman, B. J. (2002). Becoming a self-regulated learner: An overview. *Theory into practice*, 41(2), 64-70.



## Application of Generalized Linear Mixed Models in R: A Case Study with Bellbirds

**Sida Seckin Kurt<sup>1\*</sup>, Özge Kuran<sup>2</sup>**

<sup>1</sup>Dicle University, Graduate School of Natural and Applied Science, Department of Statistics, 21280, Diyarbakır, Türkiye

<sup>2</sup>Dicle University, Faculty of Science, Department of Statistics, 21280, Diyarbakır, Türkiye

\*Corresponding author e-mail: sida.seckin@gmail.com

### Abstract

Through the advantages of employing mixed models instead of the conventional fixed effects models, certain datasets can be more effectively comprehended. Repeated measures data, in particular, is highly compatible with mixed models. These repeated measures can serve as random effects, thereby enhancing the modeling process within the mixed model framework. Statistical software like R is increasingly valuable for utilizing these mixed models. By utilizing R, it is straightforward to model repeated measures data using generalized linear mixed models. In R, there exist two packages capable of executing generalized linear mixed models. The utilization of both these packages for modeling generalized linear mixed models is elucidated in a clear and succinct manner, with simple instructions provided to aid in the modeling process. Comparative analyses are conducted between the modeling techniques inherent in each of the two packages, underscoring both the advantages and limitations of each package. Additionally, methodologies for further analysis of these models are delineated. Repeated measures count data pertaining to nine species of bellbirds is employed as an illustrative example, demonstrating precisely how to implement generalized linear mixed models in both R packages.

**Keywords:** Generalized linear mixed models, Linear mixed models, Repeated measures data

### INTRODUCTION

Fixed effects models have been widely used in the analysis of many datasets for a long time. However, these models may not always adequately explain the complex structures and dependencies in the data. Random effects, which examine variability within groups or clusters, are often present in real data sets but may not be explained by fixed effects models. At this point, Linear Mixed Models (LMMs) are arised to provide a more suitable solution by incorporating both fixed and random effects. LMMs allow for a more in-depth and accurate analysis of the data, especially for repeated measurement data (Zuur et al., 2009).

The general formula for LMM (Laird and Ware, 1982) for continuous dependent variables is as follows:

$$y = X\beta + Zu + \varepsilon$$

where  $y$  is an  $n \times 1$  vector of dependent variables,  $X$  is an  $n \times p$  known design matrix for the fixed effects,  $\beta$  is a  $p \times 1$  parameter vector of fixed effects,  $Z$  is an  $n \times q$  known design matrix for the random effects,  $u$  is a  $q \times 1$  vector of random effects and  $\varepsilon$  is an  $n \times 1$  vector of random errors. It is assumed that  $u$  and  $\varepsilon$  follow independent and multivariate Gaussian distributions such that  $\begin{bmatrix} u \\ \varepsilon \end{bmatrix} \sim N\left(\begin{bmatrix} 0 \\ 0 \end{bmatrix}, \sigma^2 \begin{bmatrix} G & 0 \\ 0 & R \end{bmatrix}\right)$  where  $G$  and  $R$  are known positive definite matrices. Then,  $var(y) = \sigma^2 H$  where  $H = ZGZ' + R$ .

LMMs allow for the modeling of hierarchical structures and dependencies in data by incorporating random effects (Gelman and Hill, 2007). For instance, when repeated measurements are taken on same individuals, the differences between these individuals can be included in the model as random effects. However, LMMs are only suitable for continuous dependent variables and may not be sufficient for

different types of dependent variables such as binary, count, or categorical variables (Bates et al., 2015). Therefore, Generalized Linear Mixed Models (GLMMs) (Gelman and Hill, 2007) are preferred.

GLMMs are an extension of LMMs and can be used for both continuous and discrete dependent variables (Bolker et al., 2009). The general formula for GLMM is as follows:

$$g(\mu_i) = X_i\beta + Z_iu_i$$

where  $g$  is the link function that relates the mean of the dependent variable  $\mu_i$  to the linear predictor,  $\mu_i$  is the mean of the dependent variable,  $\beta$  is the vector of fixed effects coefficients,  $X_i$  is the design matrix for fixed effects,  $Z_i$  is the design matrix for random effects,  $u_i$  is the vector of random effects, assumed to follow a normal distribution with mean zero.

GLMMs can model nonlinear relationships and analyze data with different distributions. This flexibility makes GLMMs a preferred tool for many different data sets and types of analysis. GLMMs, along with the inclusion of random effects, allow for more accurate modeling of complex dependency structures in the data set (Pinheiro and Bates, 2000).

One of the primary advantages of choosing GLMMs is their ability to better capture heterogeneity and dependencies in the data set. This is particularly evident in repeated measurement data, where multiple measurements are taken on the same subject over a specific period. In such data, dependencies between measurements are inevitable, and analyses that do not account for these dependencies can yield misleading results (Zuur et al., 2009). GLMMs allow for the consideration of these dependencies, thereby enabling more reliable results.

Statistical software like R is becoming increasingly valuable for the use of these LMMs and GLMMs. GLMM predictions cannot be computed in the same way as LMM predictions due to the high-dimensional integrals involved. Therefore, approximation methods are employed. R supports three different methods for this purpose. While the default method is Laplace (McCullagh and Nelder, 1989), others include Penalized Quasi-Likelihood (PQL) (Breslow and Clayton, 1993) and Adaptive Gaussian Hermite Quadrature (AGHQ) (Tuerlinckx et al., 2006). These methods offer different computational strategies to obtain GLMM predictions, allowing models to adapt to various types of data structures.

Using R to model repeated measurement data with GLMMs is straightforward. The aim of this study is to implement GLMMs in R and examine their effectiveness on repeated measurement data. Specifically, we will demonstrate how GLMMs can be applied using two different R packages and conduct a comparative analysis of these packages. The study will utilize repeated count measurement data of bellbirds species obtained from Dawber's (2009) study to illustrate the practical application of these models. This aims to enable researchers and data analysts to effectively utilize GLMMs for analyzing complex datasets.

## MATERIAL AND METHODS

### Material

This study utilizes population data of bellbirds obtained from Dawber's (2009) research. The data collected by Dawber include information about bellbirds' habitats, behaviors, feeding habits, and population dynamics. These data pertain to bird counts obtained from continuous monitoring studies conducted since 2004 (Dawber, 2009).

#### *The Collection of the Data*

Each year, Dawber (2009) counted the numbers of different bird species in the study area and two control areas. Twelve transects were randomly placed in the study area, and six transects were placed in each of the two control areas. Each transect was counted five times on three separate days of a week, every day of each year. These transects, located in both the study and control areas, were utilized to count the bird populations in specific areas.



In our study is conducted to understand the behaviors and population dynamics of bellbirds in specific regions.

## Methods

### *Data Modeling and Statistical Analysis*

For the analysis, it is assumed that the Poisson distribution is used, with each bird species treated as a separate response variable. Fixed effects are determined as year and treatment (Treatment). These variables are of specific interest in our analysis. Random effects are defined as transect (Transect), count (Count), and repetition (Rep). Transects and days of observation are assumed to be potentially correlated with each other, hence these variables are defined as random effects.

Using LMMs, an analysis is conducted to determine the changes in bird counts over the years and the differences between treatment and control areas. These analyses are performed using R statistical software. Initially, both LMMs and GLMMs are implemented using the lme4 package. Subsequently, the same models are applied using the nlme package.

The collected data is imported into the R environment, and missing or erroneous values are corrected to prepare it for analysis. A suitable GLMM is selected to explain Bellbirds' behaviors. Suitability tests and model fit improvements are conducted for model selection. Relevant variables for the analysis are identified and included in the model, including habitat characteristics, climate data, geographic factors, and observed behaviors. The selected GLMM is implemented using R packages, and results are obtained. The obtained results are statistically evaluated and interpreted. Significant findings and insights regarding Bellbirds' behaviors are made.

In our study, GLMM is used to understand the behaviors and population dynamics of Bellbirds in a specific region. R packages such as lme4, glmmTMB, and nlme are utilized for data analysis. Initially, LMM is implemented, considering only Transect as a random effect in this model. Subsequently, an appropriate GLMM is applied. Modeling GLMMs is very similar to modeling LMMs, with the only difference being specifying which exponential family the dependent variable comes from.

## RESULTS

First, a LMM is applied. In this model “lmm”, only Transect is considered as a random effect. The variables are defined as factors. After all variables are created, the data are modeled.

```
> attach(birds)
> Treatment<-Area==1
> Treatment<-factor(Treatment)
> fRep<-factor(Rep)
> fCount<-factor(Count)
> fTransect<-factor(Transect)
> library(lme4)
> lmm<-lmer(BellbirdTotal~I(Year-2003)*Treatment +(1|fTransect))
```

The lme4 package is loaded. An LMM is created using the lmer() function. BellbirdTotal is the dependent variable, with Year and Treatment as independent variables, and Transect as the random effect. Transect is not a single random effect; it includes Count and Rep effects. The “lmm1” model

**V. INTERNATIONAL APPLIED STATISTICS CONGRESS (UYİK - 2024)**  
**İstanbul / Türkiye, May 21-23, 2024**

involves three levels of random effects. Therefore, modeling is done using the lmer() function. After creating the model, it is summarized.

```
> lmm1<-lmer(BellbirdTotal~I(Year-2003)*Treatment + (1|fTransect/fRep/fCount))
> summary(lmm1)
```

Since the lmer() function does not provide p values, the nlme package is loaded to obtain these values. "lmm2" model is created using the nlme package to evaluate model fit and summarized accordingly.

```
> library(nlme)
> lmm2<-lme(BellbirdTotal~I(Year-2003)*Treatment, random=~1|fTransect/fRep/fCount)
> summary(lmm2)
```

```

      AIC      BIC    logLik
5569.817 5613.764 -2776.909

Random effects:
Formula: ~1 | fTransect
      (Intercept)
StdDev:  0.4333816

      Formula: ~1 | fRep %in% fTransect
      (Intercept)
StdDev:  0.06749594

      Formula: ~1 | fCount %in% fRep %in% fTransect
      (Intercept) Residual
StdDev:  0.2278353 1.096114

Fixed effects: BellbirdTotal ~ I(Year - 2003) * Treatment
              Value Std.Error DF   t-value p-value
(Intercept)    1.595556 0.1529995 1617  10.428500  0.0000
I(Year - 2003)  0.024444 0.0258356 1617   0.946152  0.3442
TreatmentTRUE  -0.536111 0.1211795 1617  -4.424091  0.0000
I(Year - 2003):TreatmentTRUE 0.218333 0.0365371 1617   5.975656  0.0000
Correlation:
              (Intr) I(Yr-2003) TrTRUE
I(Year - 2003)          -0.507
TreatmentTRUE          -0.396  0.640
I(Year - 2003):TreatmentTRUE  0.358 -0.707   -0.905

Standardized Within-Group Residuals:
      Min       Q1       Med       Q3       Max
-2.38564243 -0.71382741 -0.04356208  0.62448070  4.04287664

Number of Observations: 1800
Number of Groups:
      fTransect      fRep %in% fTransect fCount %in% fRep %in% fTransect
              12              36              180
```

In "lmm2" model, the effect of the interaction between Year and Treatment on Bellbird count is examined. Although the interaction is significant, the high correlation of Treatment indicates that the model is misspecified. Assuming that the dependent variable is normally distributed, modeling these data is incorrect, and it is deemed more appropriate to model the data with GLMM.

Subsequently, a GLMM is implemented. The data are modeled using the lmer() function, but the dependent variable follows a Poisson distribution. A GLMM with a Poisson distribution is created using the lmer() function and Laplace method, and the model is summarized.

**V. INTERNATIONAL APPLIED STATISTICS CONGRESS (UYIK - 2024)**  
**İstanbul / Türkiye, May 21-23, 2024**

```
> glmm<-lmer(BellbirdTotal~I(Year-2003)*Treatment+(1|fTransect/fRep/fCount),
  family = poisson)
> summary(glmm)
```

```
> summary(glmm)
Generalized linear mixed model fit using Laplace
Formula: BellbirdTotal ~ I(Year - 2003) * Treatment +(1 | fTransect/fRep/fCount)
Family: poisson(log link)
AIC BIC logLik deviance
1668 1706 -826.9 1654
Random effects:
Groups Name Variance Std.Dev.
fCount:(fRep:fTransect) (Intercept) 5.0000e-10 2.2361e-05
fRep:fTransect (Intercept) 1.5002e-03 3.8733e-02
fTransect (Intercept) 8.2180e-02 2.8667e-01
number of obs: 1800,
groups: fCount:(fRep:fTransect), 180; fRep:fTransect, 36; fTransect, 12

Estimated scale (compare to 1 ) 0.8607026

Fixed effects:
Estimate Std. Error z value Pr(>|z|)
(Intercept) 0.43416 0.10312 4.210 2.55e-05 ***
I(Year - 2003) 0.01427 0.01825 0.782 0.434050
TreatmentTRUE -0.31800 0.08803 -3.612 0.000303 ***
I(Year - 2003):TreatmentTRUE 0.12269 0.02552 4.807 1.53e-06 ***
---
Signif. codes: 0 '***' 0.001 '**' 0.01 '*' 0.05 '.' 0.1 ' ' 1

Correlation of Fixed Effects:
(Intr) I(Yr-2003) TrTRUE
I(Yer-2003) -0.536
TretmntTRUE -0.410 0.628
I(Y-2003):T 0.383 -0.715 -0.912
```

In “glmm” model, the number of Bellbirds is examined under a Poisson distribution, and Transect, Rep, and Count factors are included as random effects. A significant decrease in AIC value compared to LMM is observed, highlighting that GLMM is much better.

After applying the models, comparisons are made to determine the most suitable model. A comparison is made between LMM and GLMM.

```
> anova(lmm,glmm)
```

```
Data:
Models:
lmm: BellbirdTotal ~ I(Year - 2003) * Treatment + (1 | fTransect)
glmm: BellbirdTotal ~ I(Year - 2003) * Treatment + (1 | fTransect/fRep/fCount)
Df AIC BIC logLik Chisq Chi Df Pr(>Chisq)
lmm 5 5558.9 5586.3 -2774.4
glmm 7 1667.8 1706.3 -826.9 3895 2 < 2.2e-16 ***
```

As a result of model comparisons, lower AIC and BIC values and a significant p-value indicate that GLMM fits the data better.



## DISCUSSION AND CONCLUSION

This study has aimed to demonstrate the use of GLMMs in R. The availability of GLMMs for understanding the behaviors and population dynamics of Bellbirds has been examined. Two different models, namely LMM and GLMM, have been utilized.

The analyses have shown that GLMM considering the Poisson distribution better explains the population dynamics of Bellbirds. By including Transect, Rep, and Count factors as random effects, this model has constructed a more suitable model, implying better accommodation of the heterogeneity and natural variations in Bellbirds' distribution. Additionally, model comparisons have indicated that GLMM outperformed LMM, suggesting that the Poisson distribution better describes the number of Bellbirds and the model exhibits better fit.

In conclusion, this study highlights the importance of using GLMMs to understand the population dynamics of Bellbirds. Future research should delve more deeply into the effects of different factors (such as habitat changes, climate variations, etc.) on the Bellbird population. These findings could significantly contribute to the conservation and management of Bellbirds in nature conservation and biodiversity management practices.

## References

- Bates D, Mächler M, Bolker B, Walker S, 2015. Fitting Linear Mixed-Effects Models Using lme4. *Journal of Statistical Software*, 67(1): 1-48.
- Bolker BM, Brooks ME, Clark CJ, Geange SW, Poulsen JR, Stevens MH, White JS, 2009. Generalized linear mixed models: a practical guide for ecology and evolution. *Trends in Ecology & Evolution*, 24(3): 127-135.
- Breslow NE, Clayton DG, 1993. Approximate inference in generalized linear mixed models. *Journal of the American Statistical Association*, 88(421): 9-25.
- Dawber C, 2009. Generalised linear mixed models and its application in R, Summer Research Project. University of Canterbury, Department of Mathematics and Statistics, Christchurch, New Zealand.
- Gelman A, Hill J, 2007. *Data Analysis Using Regression and Multilevel/Hierarchical Models*. Cambridge University Press, USA.
- Laird NM, Ware JH, 1982. Random-effects models for longitudinal data. *Biometrics*, 38: 963-974.
- McCullagh P, Nelder JA, 1989. *Generalized Linear Models*, 2nd ed., Chapman & Hall, UK.
- Pinheiro JC, Bates DM, 2000. *Mixed-Effects Models in S and S-PLUS*. Springer, USA.
- Tuerlinckx F, Rijmen F, Verbeke G, De Boeck P, 2006. Statistical inference in generalized linear mixed models: A Review. *British Journal of Mathematical and Statistical Psychology*, 59(2): 225-255.
- Zuur AF, Ieno EN, Walker N, Saveliev AA, Smith GM, 2009. *Mixed Effects Models and Extensions in Ecology with R*. Springer, USA.

## Funding

The present study was funded by the Dicle University Scientific Research Projects Coordinatorship (DUBAP) through Project FEN.23.029.

## Conflict of Interest

The authors have declared that there is no conflict of interest.

## Author Contributions

The authors have equally contribution.

## Smart Food Recognition with YOLOv8 Models

**Ali Kerem Güler<sup>1\*</sup>, Ali Musa<sup>1</sup>, Osman Saraç<sup>1</sup>, Mustafa Tarım<sup>2</sup>, Mehmet Göktürk<sup>3</sup>**

<sup>1</sup>Protel A.Ş., Software, Machine Learning Department, 34394, İstanbul, Türkiye

<sup>2</sup>Protel A.Ş., Software, Software Department, 34394, İstanbul, Türkiye

<sup>3</sup>Gebze Technical University, Faculty of Engineering, Computer Engineering, 41400, Kocaeli, Türkiye

\*Corresponding author e-mail: aguler@protel.com.tr

### *Abstract*

*This study introduces a new method that uses YOLOv8 models for intelligent food recognition in restaurants. Its purpose is to make clients happy, reduce wait times and increase efficiency. In this work, we combine object detection with classification to identify different items on a customer's tray. Doing this quickens payment thus improving overall service delivery. The system development involves datasets collection from one pilot restaurant setting, stages of image processing as well as training using YOLOv8 algorithms among others. Even though there were difficulties in representing classes having few training samples; it was found out through experiments that the model achieved high mAPs across various food categories. By so doing, such an approach will help eateries streamline their processes – leading to cost savings on top of fostering more interactions with the clientele. The research paper highlights how powerful these technologies can be when applied within the context of intelligent services offered by modern-day dining establishments known as 'smart'.*

**Keywords:** Food Recognition, YOLO, Object Detection, Classification.

### **INTRODUCTION**

Customer satisfaction and operational efficiency are crucial in today's service business for achieving and sustaining an advantage in the marketplace. In the restaurant industry, it is crucial to minimize client wait times and improve service quality in order to achieve company success. The automation of payment and ordering processes in self-service restaurants has the potential to enhance operational efficiency and enhance customer experience. Automated tray recognition solutions, which utilize cameras and machine learning, are becoming highly valuable tools in the competitive and fast-paced self-service restaurant industry.

During peak hours, it is essential for restaurant operations to quickly handle order taking and payment processes as this improves customer satisfaction and eases the workload on staff. Labor costs are increased by manual methods of taking orders and processing payments while technology-based solutions can make these processes more efficient hence reducing costs and improving service quality. Food recognition technologies present a new way of solving this problem.

This study focuses on creating a system that uses computer vision and deep learning techniques to automatically recognize food items on trays of clients then send the details to the Point of Sale (POS) for billing. By putting cameras near the restaurant POS which will quickly identify what clients have picked, the system is expected to cut down waiting time at queues significantly thus enhancing general operational efficiency. Food recognition systems provide a novel solution to this requirement.

This research has three main contributions. Firstly it introduces a new method that reduces waiting times thus improving customer experience in restaurants. Also it enhances the efficiency of operations while enabling data driven decision making. By so doing it helps these facilities serve clients faster and better thereby leading to increased satisfaction levels among them and overall business performance improvement. The paper is organized as follows: Literature Review section examines relevant studies in the field, Methodology section discusses the approaches used. In the Findings and Discussion section,

the results are debated, and finally, the paper concludes with the Conclusion section where the outcomes are presented.

This study implements YOLOv8 models, a contemporary approach for object recognition (plates, bowls, etc.) from images, and classifying the meals based on these objects.

Custom food datasets were created by installing cameras into a pilot restaurant environment, and not by using pre-existing databases, to train the model.

Training of the low-parameter object recognition algorithm using a given amount of labeled data was done in such a way that the number of data labeling procedures was partially automated. Then, unlabeled data was autonomously categorized using active learning.

The research is focused on local Turkish food that encompasses a large variety of dishes and, additionally, on small data sets for the procedure of food recognition.

## LITERATURE REVIEW

To recognize foods after they have been consumed, Bettadapura et al. (2015) have matched restaurant menus together with food photos and have used advanced computer vision tools supported by online databases. Aguilar et al. (2017) assessed the performance of merging classifiers that were created by different CNN models on two different datasets namely Food-101 and Food-11. In another study, Aguilar et al. (2018) employed semantic food detection methods for enabling recognition of foods as well as segmenting them from other objects which attained up to 90% F1 score across various datasets. Anzawa et al. (2019) introduced a framework specific to buffets where they aimed primarily at recognizing several kinds of foods within one image or multiple images related. As stated by Min and his team (2023), Food2K dataset was developed which contains more than one million images belonging to 2000 categories; additionally they proposed Progressive Region Enhancement Network (PRENet) for better performance in food recognition tasks through combining different architectures and strategies into single approach.

Yang and colleagues (2010) put forward a novel technique to improve food recognition accuracy, which they did by considering parts of a meal and their spatial relationships. According to Ciocca et al. (2016), there is a new dataset for food recognition experimentation that uses different visual descriptors as well as classification methods. Zahisham et al. (2020) worked on recognizing foods with ResNet-50 architecture in order to achieve high accuracy rates through fine tuning pre-trained models.

Kagaya and co-authors (2014) generated a food recognition dataset using pictures from a public food logging system and increased food recognition accuracy to around 93.8% by optimizing CNN hyperparameters compared to conventional methods. Herranz et al. (2016) proposed a probabilistic model that combines the location of restaurants and the contents of their menus with visual features for recognizing foods in restaurants. Yu et al. (2016) addressed the problem of recognizing dishes with deep learning architectures, where their main goal was to use transfer learning and fine-tuning techniques to improve recognition results. Martinel et al. (2018) introduced an approach called Wide-Slice Residual Network (WISeR) which is specifically designed for food recognition task. Abiyev and Adepoju (2024) showed that combining self-attention mechanisms together with CNN models can be highly effective in this area, achieving 96.40 % and 95.11 % accuracy rates on two different datasets for food recognition.

## METHODOLOGY

### The Dataset

This study's dataset originated from a test restaurant run by Protel Inc. serving breakfast and lunch. The data collection started with setting up a camera near the point of sale of the restaurant overlooking the trays from above vertically. Video footage was taken during lunch hours (12:00 PM - 2:00 PM) over the course of three days after installation and calibration of the camera. These videos had a resolution of 1920x1080 pixels and were recorded at 30 frames per second, showing food images belonging to 16



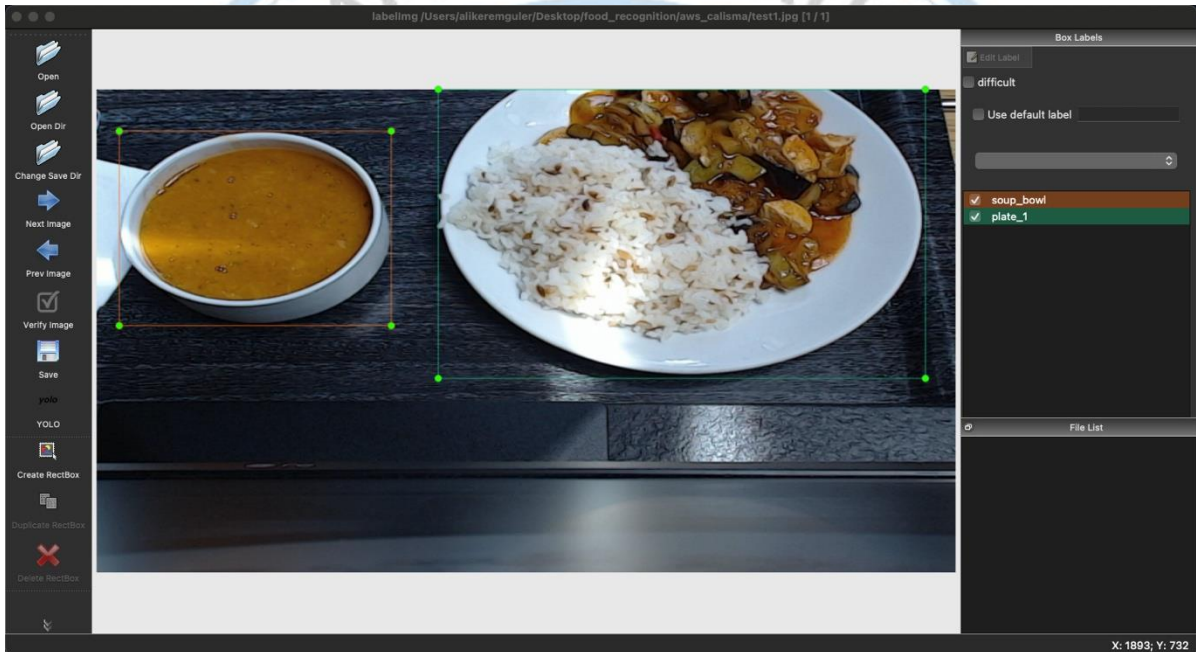
different categories. Each video file was named systematically based on its recording time which also included date stamps so that they could be easy to track back later on. There was an effort made when shooting these clips; it was intended that they should be diverse enough in terms of dishes served and their styles of presentation so as not to limit any possible variations which might come up during coding this software with regard to different meal types complexities.

### Data Preprocessing

The data processing part of the study divided into different stages that focused on object recognition and classification. Every process was customized using this method.

#### Object Detection

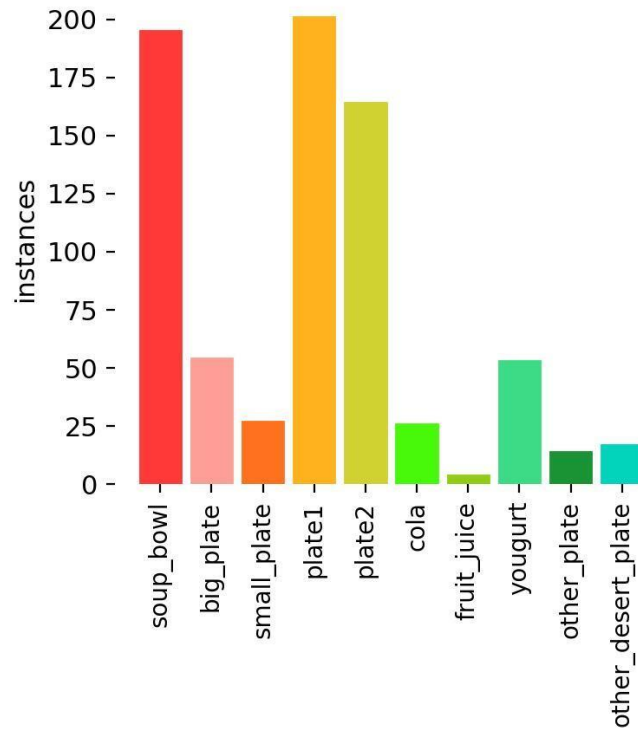
In the beginning, video frames were broken down into individual images to build an image dataset. A manual approach was used to identify images without trays (considered as noise) during this stage and remove them from the set. Following the cleaning operation, a total of 360 photographs showing different types of food on various containers were obtained.



**Figure 1.** Image annotation on visual data using the labelImg tool

Images were labeled for the object recognition process using the labelImg tool, as indicated in Figure 1, under ten different categories: soup\_bowl, big plate, small plate, plate1, plate2, cola, fruit juice, yogurt, other plate, and other dessert plate. LabelImg is an open-source labeling tool used for object recognition projects, capable of generating label files in three formats: XML, Pascal VOC, and YOLO. Accurate labeling is crucial for the correct recognition of objects. Each labeled image was saved with object label information and coordinates according to the requirements of the YOLOv8 model (jocher et al., 2023), which was designated as the object recognition algorithm.

The first 100 images were manually labeled, and this initial set was used to train a small-scale YOLO object recognition model to automate the remainder of the labeling process. Subsequently, the remaining 260 images were presented to the trained object recognition model. Objects detected in each image were recorded with their class label numbers and coordinates for a larger-scale object recognition model. This process is also known as active learning (settles, 2009), which partly automates the data labeling process, making it semi-autonomous.



**Figure 2.** Distribution of Labels

Upon examining the label distribution presented in Figure 2, it is observed that the 'plate2' label has the highest representation in the dataset with approximately 200 examples. In contrast the number of examples for each of these labels is smaller: 'small\_plate', 'fruit\_juice' or 'yogurt' have few representations. The problem arises from having some categories such as "other\_plate" and "other\_dessert\_plate" that contain a very low number (less than 25 each) this can lead machine learning models into incorrect classification of these kinds items since there are too few observations about them. This situation may cause an overfitting during training because certain classes will be captured more often than others due their scarcity among training instances. Therefore we chose YOLOv8 model which has been designed specifically for handling datasets characterized by wide label variety alongside imbalanced data distribution. Afterwards 90% (324 images) were used as training data while 10% (36 images) remained untouched meant solely for validating whether our trained detector generalizes well on unseen pictures.

#### *Classification*

In this phase, images that had been processed through the object recognition model were used, and the detected objects were cropped according to their categories and saved. Subsequently, these categorized images from the object recognition model were manually matched and recorded with the updated menu list information across 16 different food and beverage classes (broccoli, fizzy drinks, stew, cherry, bulgur salad, cola, pasta salad, potato dish, rice, salad, peach, vermicelli soup, soy sauce chicken, tarhana soup, chicken meal, yogurt). After this recording process, it was found that not every class had sufficient and equal numbers of data necessary for a successful classification model.

The insufficiency of data and the unequal distribution among categories have a negative impact on the teaching process of classification models. To solve this problem, it has been used some approaches like image augmentation or web scraping (Mitchell, 2018). About image augmentation, this technique is applied to images taken in a restaurant so that there will be no more differences between each class (40 pictures per class). This technique includes approaches such as horizontal and vertical shifting,

shearing by a specific angle, random zooming, and filling the spaces created after the augmentation process. For web scraping, a function written in the Python programming language was used to download images from the web browser according to the specified class name and desired number of images. For this study, 200 images were downloaded for each class via web scraping. However, after a data cleaning process to select only relevant images, the number of images per class was reduced. In some classes, the presence of many noisy or irrelevant images necessitated further data cleaning, which resulted in variations in the number of images per class after the cleaning process.

Following the partial solution of problems stemming from paucity of data and class imbalance, a separation of the dataset meant for the classification model into a training set and a validation set occurred. To train the model, 90% of the total dataset, which comprised 2840 images, was utilized (2590 images), while the remaining 10% (250 images) were left for the model's validation process. Such splitting is important as it helps to evaluate the overall performance and classification accuracy of the model.

### **Modelling**

This section discusses models for object recognition and classification, including models used in classifying food objects. YOLOv8 algorithms have been implemented to recognize plates from images and food classification. YOLOv8 has the ability to predict bounding boxes and object classes as well. Moreover, it is faster than its previous versions while maintaining high performance levels during the recognition process thanks to its speed improvement features. This algorithm shows good results even with complex images due to high speed of detection speeds coupled with advanced algorithmic structure which brings out high accuracy levels on various intricate datasets.

#### *Training of the Object Detection Model*

To be able to train object recognition, a 'small' model of YOLOv8 was chosen due to the size of the dataset. This is because when working with small datasets, using few parameters can lower overfitting risks and speed-up training as well. Another advantage of choosing a smaller model is that it demands less computational resources and hardware power as compared to bigger models. Nonetheless, among many factors that could have been considered, the reason behind picking this particular model lies on the fact that there was limited data available. This situation ensured that the capacity of the model was proportional to the quantity of the dataset, thereby enhancing the efficiency of the training process. For training the object recognition model, a configuration of 120 training epochs, with 640x640 pixel images and a single batch size, was preferred. This configuration was chosen to optimize the efficiency of the training process and the accuracy of the results.

#### *Training of the Classification Model*

Foods have been classified using a deep learning-based classification algorithm of YOLOv8. In this algorithm, there are numerous layers that decide for each object in an image what could be its possible classes and with what probability score they belong to it. The target of this method is to have high accuracy rates on datasets. So as to train them on small datasets, YOLOv8 "small" model was used because it has fewer parameters which decreases overfitting risk on small datasets while also speeding up training due to its less computational requirements. The classification model went through 50 epochs of training using pictures with 140 x 140 pixels resolution. Number of training epochs was established by experimentations aimed at maximizing accuracy of models.

## **RESULTS AND DISCUSSION**

According to the model outputs and performance metrics, the efficiency of YOLOv8 object recognition and classification algorithms were evaluated in this section.



*Results of the Object Recognition Model*

The performance of the object recognition model has been evaluated based on its outputs and predictions on test data.

$$mAP = \frac{1}{C} \sum_{c=1}^C AP_c$$

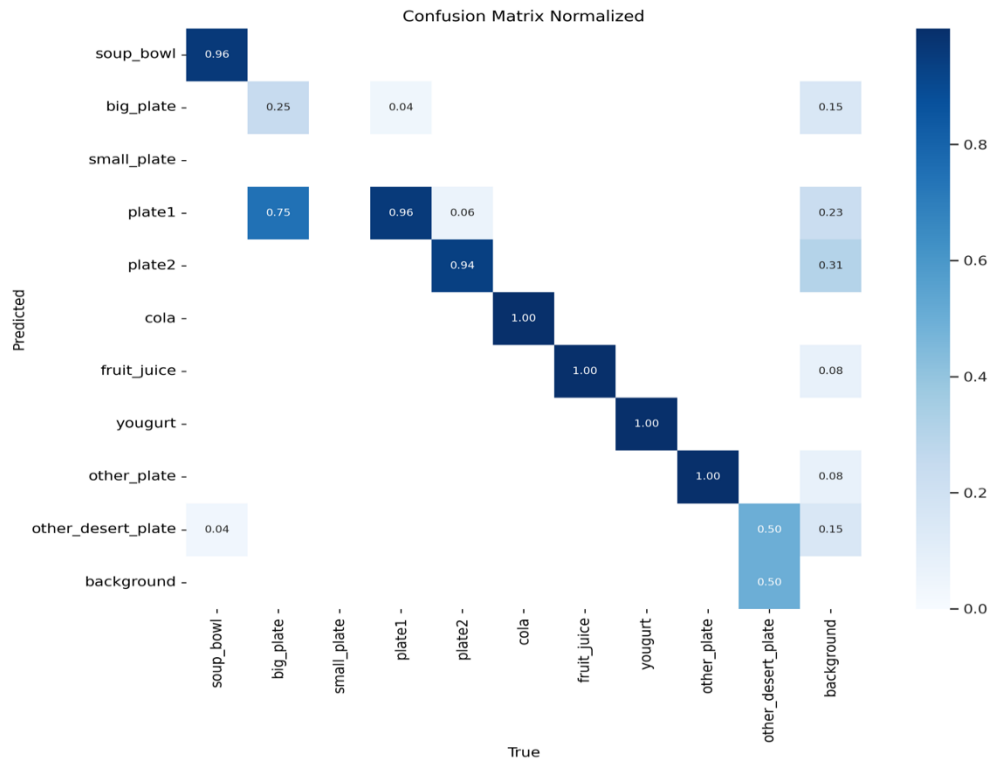
(Equation I)

The performance of the model for recognizing objects is evaluated based on mAP (mean Average Precision) score with reference to the validation dataset and confusion matrix. The average accuracy of the detected objects in the model across all classes is represented by the mAP score which is calculated using the formula in Equation II. Essentially, this score is an important indicator of how well the model perceives and classifies items. In object recognition models, a high mAP indicates that they have few false positives while being able to detect objects with great precision. It is expected that both mAP50 and mAP50-95 scores should be high for a successful study. mAP50 represents the model's ability to correctly detect objects at a 50% IoU (Intersection over Union) threshold. IoU is a measure that shows how much the bounding box predicted by the model overlaps with the actual bounding box. mAP50-95 represents the average performance of the model at IoU thresholds from 50% to 95%. This wide range in scores indicates how effectively the model can detect objects of varying sizes.

**Table 1.** Object-Based Performance of the Model

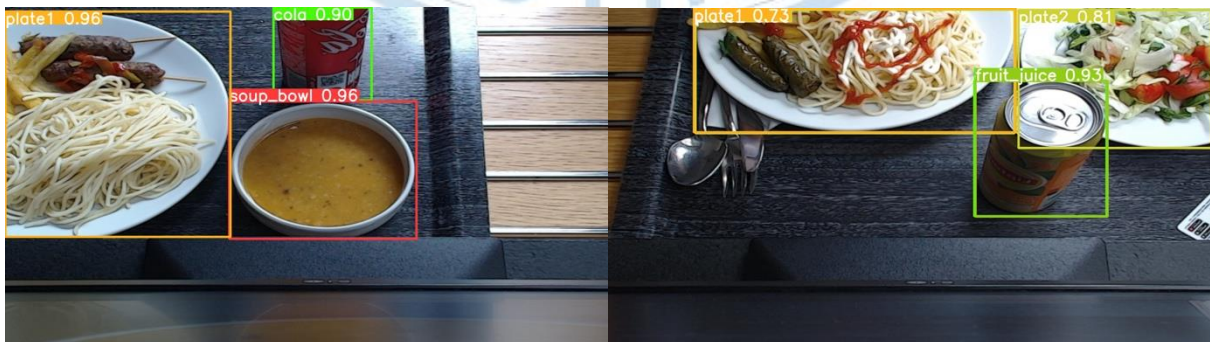
Category	Images	Instances	Box(P)	Box(R)	mAP50	mAP50-95
all	36	89	0.825	0.854	0.904	0.881
soup_bowl	36	28	0.963	0.939	0.964	0.933
big_plate	36	4	1.000	0.446	0.759	0.759
plate1	36	24	0.911	0.958	0.967	0.967
plate2	36	17	0.878	0.846	0.963	0.957
cola	36	4	0.938	1.000	0.995	0.995
fruit_juice	36	1	0.455	0.455	0.995	0.895
yogurt	36	8	0.972	1.000	0.995	0.924
other_plate	36	1	0.892	1.000	0.995	0.995
other_desert_plate	36	2	0.417	0.500	0.502	0.502

Based on Table 1, the model obtained high accuracy scores – 90.4% mAP50 and 88.1% mAP50-95. This information means that the model is capable of detecting various objects easily. However, it performed poorly on some groups with few instances like ‘fruit\_juice’ and ‘other\_desert\_plate’. The reason for this could be that there were too few samples from these categories in the training data set. To address this issue additional information needs to be collected while applying data augmentation methods for dataset enrichment towards better recognition of such uncommon classes. This approach can help address the imbalance and provide the model with more examples to learn from, potentially increasing its accuracy in underrepresented categories.



**Figure 3.** Confusion matrix of the object detection model

The confusion matrix presented in Figure 3 demonstrates the performance of the Yolov8 object detection model on the validation dataset during the training process. The main goal of this matrix was to perceive how accurate the model is in detecting every single class and what the level of confusion between classes is. The columns show the real classes, and the rows indicate the model's predictions. The numbers here are normalized to the fact that the sum of each row is equal to 1. The whole confusion matrix, above all, shows that some classes are recognized very nice, whereas others are low performers. Label classes with low performance generally have a high number of false positives, and label classes that are close to each other are confused due to visual similarities. In particular, although the 'plate1' class was detected with a good accuracy of 75%, it showed a 25% confusion with the 'big\_plate' class. This is due to the fact that objects of similar sizes and shapes are difficult to distinguish by the model. On the other hand, label classes such as other\_plate, fruit\_juice and cola in the validation set were detected with 100% accuracy and the model showed high success in distinguishing such items. The reason for this is that the data was randomly split into train and validation sets, and the images belonging to this label class remained entirely in the train set.

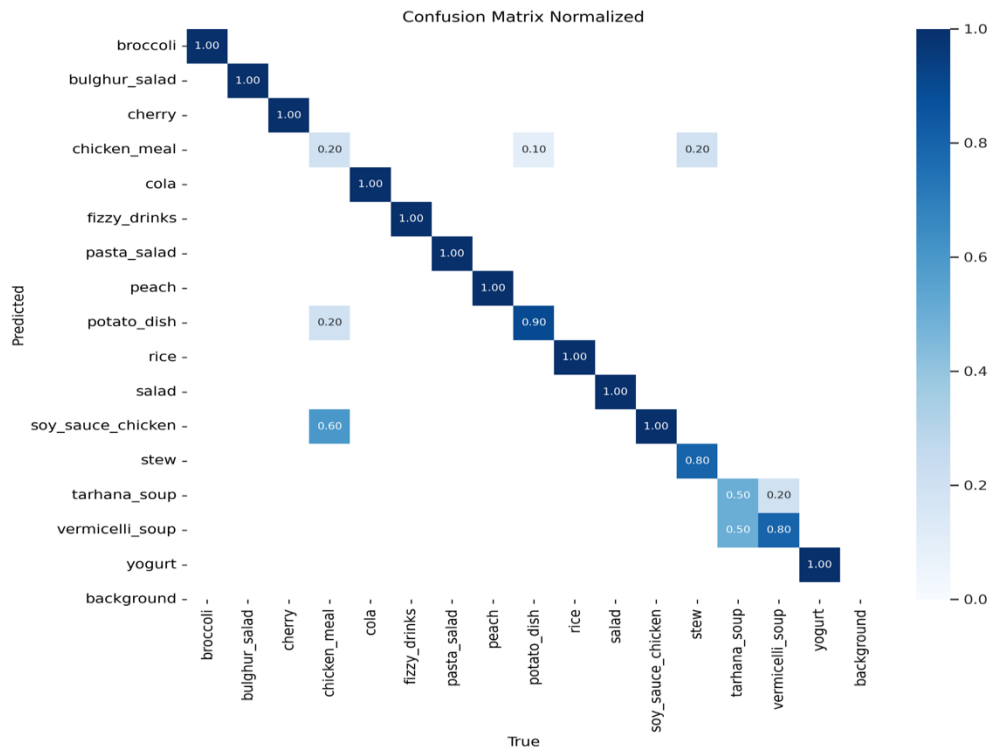


**Figure 4.** Object recognition model's detection results on two different test images

In order to check the detection capabilities of the object recognition model, a portion of the data of the model that was not used in the process of training was reserved as the test set. The data within the test set were presented to the trained model to observe whether the objects in the visual were accurately detected. The detection results carried out on two of the test images and the confidence threshold values determined for each bounding box are shared in Figure 4.

*Results of the Classification Model*

This section evaluates the performance of the classification model. The confusion matrix and the results obtained by the model from the test image have been examined.



**Figure 5.** Confusion matrix of the classification model

The confusion matrix found in Figure 5 displays the precision of the classification model in predicting photos of different food items. For example, a confusion matrix states that some food categories on the validation set, such as 'broccoli', 'bulghur\_salad', 'cherry', 'cola', 'fizzy\_drinks', 'pasta\_salad', 'peach', 'rice', 'salad', 'stew', and 'yogurt', were classified with very high accuracy, one class close to 100%, by the model. This indicates that the model successfully recognizes images from these categories without confusing them with other categories. However, in addition to the classification of 'say\_sauce\_chicken' with high accuracy, this class has also acquired a remarkable number of false positives. This class is largely misclassified as the 'chicken\_meal' class by the model. Indeed, during the investigation of the images of both categories, it is found that 'chicken' chunks are present in each and some of the food colors are similar. On the other hand, the categories such as 'chicken\_meal', 'potato\_dish', 'tarhana\_soup', and 'vermicelli\_soup' exhibit decreased classification performance and increased confusion in these categories. For instance, 'tarhana\_soup' is correctly proposed as the main category with 50% accuracy. It is also wrongly predicted 50% of the time with the initial category being 'vermicelli\_soup'. Also, the 'vermicelli\_soup' category is correctly classified with 80% but 20% of the time, it is confused with 'tarhana\_soup'.





**Figure 6.** Classification results performed on the test image

A test image containing soy sauce chicken was presented to the classification model. Subsequently, the classification results obtained by the model on this image were evaluated. The classification results in Figure 6 are expressed with a results table showing which class the model assigned the presented image with the highest probability. This table contains the top five probabilities of the model's predictions, along with the classes corresponding to these probabilities. Based on the given results, the model, with a 96% probability, classified the image in the test as 'soy sauce chicken'. With very small probabilities, the other categories were rated as 'stew' with 0.03%, 'chicken meal' with 0.01%, 'potato dish' with 0.0%, and 'pasta salad' with 0.0%.

#### *General Evaluation*

The predictions made by YOLOv8 models on validation data demonstrate that plates and foods can be detected and classified with high accuracy. The object detection results presented in Figure 4 of the "Results of the Object Detection Model" section demonstrate that the algorithm has the ability to recognize different types of food and drink also places them in their bounding boxes with the highest confidence thresholds. The classification results presented in Figure 5 of the "Results of the Classification Model" part also show that the model can rightly allocate the categorizations of the validation data to the corresponding classes. The outcomes displayed in both figures stand to the fact that the algorithm works better even on a small and colourful dataset. The outcomes show the applications that the models bring with their strengths in the real world conditions. Particularly, training efforts with more comprehensive and larger datasets can further enhance the models' adaptability to data diversity and improve their performance.

#### **CONCLUSION**

Within this study, the effectiveness of YOLOv8 algorithms in the detection and classification of the objects in the image dataset got from a restaurant environment was investigated. On the validation dataset, high mAP scores showed that the models are good at detecting and recognizing objects successfully. Nonetheless, the poor performance in small categories with a few examples has revealed the role of the diversity and the size of the dataset in the model training process. These conclusions stress the necessity of more data collection and the use of data augmentation techniques in order to adjust to the diversity of data in various real-life conditions. Thus, it is inferred that YOLOv8 models can be applied for practical tasks and real-life situations and can be a starting point for future research.

#### **References**

- Bettadapura V, Thomaz E, Parnami A, Abowd GD, Essa I, 2015. Leveraging context to support automated food recognition in restaurants. 2015 IEEE Winter Conference on Applications of Computer Vision, January 2015, Waikoloa, HI, USA, pp. 580-587.
- Aguilar E, Bolaños M, Radeva P, 2017. Food recognition using fusion of classifiers based on CNNs. Proc. 19th Int. Conf. Image Analysis and Processing-ICIAP, September 11-15, 2017, Catania, Italy,

- vol. 19, pp. 213-224.
- Aguilar E, Remeseiro B, Bolaños M, Radeva P, 2018. Grab, pay, and eat: Semantic food detection for smart restaurants. *IEEE Transactions on Multimedia*, vol. 20, no. 12, pp. 3266-3275.
- Anzawa M, Amano S, Yamakata Y, Motonaga K, Kamei A, Aizawa K, 2019. Recognition of multiple food items in a single photo for use in a buffet-style restaurant. *IEICE TRANSACTIONS on Information and Systems*, vol. 102, no. 2, pp. 410-414.
- Min W, Wang Z, Liu Y, Luo M, Kang L, Wei X, Jiang S, 2023. Large scale visual food recognition. *IEEE Transactions on Pattern Analysis and Machine Intelligence*.
- Yang S, Chen M, Pomerleau D, Sukthankar R, 2010. Food recognition using statistics of pairwise local features. *Proc. IEEE Computer Society Conference on Computer Vision and Pattern Recognition*, June 2010, San Francisco, CA, USA, pp. 2249-2256.
- Ciocca G, Napoletano P, Schettini R, 2016. Food recognition: a new dataset, experiments, and results. *IEEE Journal of Biomedical and Health Informatics*, vol. 21, no. 3, pp. 588-598.
- Zahisham Z, Lee CP, Lim KM, 2020. Food recognition with ResNet-50. *2020 IEEE 2nd International Conference on Artificial Intelligence in Engineering and Technology (IICAET)*, September 2020, Kota Kinabalu, Malaysia, pp. 1-5.
- Kagaya H, Aizawa K, Ogawa M, 2014. Food detection and recognition using convolutional neural network. *Proc. of the 22nd ACM International Conference on Multimedia*, November 2014, Orlando, FL, USA, pp. 1085-1088.
- Herranz L, Jiang S, Xu R, 2016. Modeling restaurant context for food recognition. *IEEE Transactions on Multimedia*, vol. 19, no. 2, pp. 430-440.
- Yu Q, Mao D, Wang J, 2016. Deep learning based food recognition. Technical report, Stanford University.
- Martinel N, Foresti GL, Micheloni C, 2018. Wide-slice residual networks for food recognition. *2018 IEEE Winter Conference on Applications of Computer Vision (WACV)*, March 2018, Lake Tahoe, NV, USA, pp. 567-576.
- Abiyev R, Adepoju J, 2024. Automatic Food Recognition Using Deep Convolutional Neural Networks with Self-attention Mechanism. *Human-Centric Intelligent Systems*, pp. 1-16.
- Settles B, 2009. Active learning literature survey.
- Mitchell R, 2018. *Web Scraping with Python: Collecting More Data from the Modern Web*. O'Reilly Media, Inc.
- Jocher G, Chaurasia A, Qiu J, 2023. Ultralytics YOLO (Version 8.0.0) [Computer software]. Available: <https://github.com/ultralytics/ultralytics>

#### **Acknowledgment**

The data sets used in this research were provided by PROTEL A.Ş.

#### **Conflict of Interest**

The authors have declared that there is no conflict of interest

## Alüminyum Alaşımli Binek Araç Jantlarının Dinamik Viraj Yorulma Testi ve Güvenilirlik Tahmini

**Alper Arslan<sup>1</sup>, A. Tanem Öztürk<sup>1\*</sup>, Deniz Elibol<sup>1</sup>  
Meriç Işık<sup>2</sup>, Selma Gürler<sup>1</sup>**

<sup>1</sup>Dokuz Eylül Üniversitesi, Fen Fakültesi, İstatistik Bölümü, 35390, İzmir, Türkiye

<sup>2</sup> R&D Center, CMS Jant ve Makina San. A.Ş. İzmir, Türkiye

\*Sorumlu yazar e-mail: a.tanem.ozturk@gmail.com

### Özet

*İstatistiksel güvenilirlik analizi, ürünlerin veya sistemlerin güvenilirliğini ölçmek amacıyla kullanılmaktadır. Bu analiz, ürünlerin güvenilirliğini değerlendirmek, potansiyel sorunları erken aşamada belirlemek, ürün geliştirmede tasarım aşamasındaki sorunları tespit etmek ve müşteri beklentilerini güvenilirlik ve dayanıklılık açısından karşılamak için önemli bir rol oynamaktadır.*

*Jant üretiminin güvenilirliği, otomobilin güvenliği, performansı, dayanıklılığı ve maliyet etkinliği açısından kritik bir rol oynar. Bu çalışmada, A356 ısıtılmış alüminyum alaşımli binek araç jantlarının farklı moment/gerilme seviyelerindeki güvenilirlik parametrelerinin incelenmesi hedeflenmektedir. A356 ısıtılmış malzemenin yorulma ömrünün belirlenmesi sayesinde A356 ile üretilecek tüm ürünler malzeme limitlerinde tasarlanabilecek bu vesileyle hafif ve rekabetçi tasarımlar yapılarak daha çevreci ürünler tasarlanıp üretilebilecektir. A356 alaşımı için kullanılan T6 ısıtılmış işlemi yaklaşık 18 saat süren, yoğun enerji sarfiyatına sebep olan bir süreçtir. Çalışma kapsamında elde edilecek çıktılar ile ısıtılmış işlem süreci bertaraf edilerek üretilmiş tüm A356 alüminyum alaşımli parçalar için yorulma ömrü kriterleri ortaya koyulmasını sağlayacaktır. Araştırmada, CMS Jant Ar-Ge merkezi bünyesinde üç farklı stres seviyesi için gerçekleştirilen binek araç jantlarının dinamik viraj yorulma testi ile hızlandırılmış ömür testi verileri analiz edilmiştir. 125, 140 ve 165 MPa stres seviyelerinde gerçekleştirilen test verileri kullanılarak jantlar için normal koşul olarak belirtilen 110 MPa seviyesi için güvenilirlik parametrelerinin tahminleri gerçekleştirilmiştir. Araştırmanın sonuçları, üretilen ısıtılmış alüminyum alaşımli binek araç jantlarının performansını artırmak ve güvenilirlik standartlarını karşılamak için tasarım aşamasında önemli bilgiler sağlayacaktır. Verilerin analizinde Reliasoft Weibull++ ve ALTA yazılımları kullanılmıştır.*

**Anahtar Kelimeler:** Güvenilirlik analizi; Hızlandırılmış ömür testi, Ters Kuvvet Kanunu modeli; Weibull dağılımı

### Giriş

Güvenilirlik, bir ürünün belirli kullanım şartları altında, belirli bir süre boyunca görevini kesintisiz ve bozulmadan yerine getirme olasılığını ifade eder. Ürünün güvenilirliğini tahmin etmek amacıyla hızlandırılmış testler kullanılarak ürünün dayanıklılığı ve performansı değerlendirilir. Bu testler, ürün geliştirme sürecinde maliyetleri azaltmak ve hafif ağırlık prensibiyle üretim yapmak amacıyla giderek yaygınlaşmaktadır.

Alüminyum jantlar, araç bileşenleri arasında kritik öneme sahiptir ve viraj yorulma testleri ile dayanıklılıkları ve yorulma ömürleri tespit edilir. Yorulma ömrü, alaşım bileşimi, mikro yapısal özellikler, kusurlar ve stres gibi faktörler tarafından belirlenir. Alüminyum jantların yorulma performansı; üretim süreci, ısıtılmış işlem, kusurlar ve yükleme durumu gibi birçok faktöre bağlıdır.

Literatürde, jant yorulma ömrü ile ilgili önemli çalışmalar mevcuttur (Kocabaşak ve Fırat, 2001; Wang ve Zhang, 2010; Li ve ark., 2007; Shang ve ark., 2008; Fırat ve ark., 2009; Raju ve ark., 2007; Ballo ve ark., 2016; Tebaldini ve ark., 2018; Koppiseti, 2022). Bu çalışmalar, A356-T6 alüminyum alaşımının yorulma davranışını ve dayanıklılığını değerlendirmektedir.

Bu projenin amacı, alüminyum alaşımli binek araç jantlarının dinamik viraj yorulma test sonuçlarını



belirlemektir. Araç virajda yol alırken janta gelen kuvvetleri simüle ederek jantın yorulma davranışı ve istatistiksel analizi yapılacaktır.

## MATERYAL VE METOT

### Metotlar

#### *Verilerin Toplanması*

Dinamik viraj yorulma testinde, aracın hareket esnasında jant üzerine etki eden kuvvetlerin benzetimi yapılarak jant dayanımı test edilmektedir. Test düzeninde, jant ve yükleme kolu ikilisinden biri sabit tutulur, diğeri döndürülerek jantın dönme hareketi oluşturulur (Koran, 2017).

Test düzeneği, jantın sabit bir çerçeveye monte edilmesi ve jant eksenine dik ve sabit bir kuvvetin jant ekseninde döndürülmesi üzerine kuruludur. Bu kuvvet, dengesiz bir ağırlığın merkezkaç kuvveti ile elde edilir. Moment değeri, ön dingil yükü, jant ofseti, lastik yarıçapı, sürtünme katsayısı ve test faktörüne göre önceden belirlenir. Test sırasında jantta herhangi bir çatlak veya hasar oluşmazsa jant testi geçer. Çatlak veya hasar oluşursa, jant testi başarısız sayılır (Koran, 2017).

Bu testlerin uygulanması sonucunda üç farklı stres seviyesinde toplamda 45 adet gözlem elde edilmiştir.

#### *Güvenilirlik*

Güvenilirlik, herhangi bir bileşen ya da sistemin belirli şartlar altında, öngörülen fonksiyonu yerine getirme olasılığı olarak tanımlanır. Güvenilirlik en geniş anlamıyla bir performans ölçüsüdür. Güvenilirlik kavramının gelişmesiyle üreticiler ellerinde olan verilerle bir bileşen veya sistemin yaşam zamanını ve güvenilirliğini tahmin etmeye çalışmışlardır. Güvenilirlik, uygulama alanı ne olursa olsun bileşenin en önemli özelliklerinden biridir. Aynı zamanda müşteri tatminini sağlar ve piyasada rekabet gücü kazanmasına etkendir.

Güvenilirliğin bazı önemli ölçüleri, güvenilirlik fonksiyonu, bozulma oranı fonksiyonu, ortalama ömür, ortalama geriye kalan ömür olarak ifade edilebilir. Güvenilirlik fonksiyonu  $R(t)$ ,  $t$  zamanında bir sistemin kendi görevlerini yapabileme olasılığı olarak da tanımlanır. Güvenilirlik fonksiyonu azalan bir fonksiyondur.  $T$  değişkeni,  $f(t)$  olasılık yoğunluk fonksiyonuna ve  $F(t)$  birikimli dağılım fonksiyonuna sahip, pozitif tanımlı sürekli bir rassal değişken olsun. Bir bileşenin güvenilirlik fonksiyonu aşağıda verilen (1) nolu eşitlik ile tanımlanır.

$$R(t)=Pr (T>t)=1-F(t)=\int f(x)dx \infty t, t>0 \quad (1)$$

#### *Weibull dağılımı*

Weibull dağılımı, ilk olarak 1951 yılında Waloddi Weibull tarafından makinelerin yaşam sürelerini tahmin etmek amacıyla kendi adıyla ortaya koymuş olduğu bir dağılımdır. Günümüzde ise yaşam süreli veri analizinde ve mühendislikte yer alan istatistiksel modellerde yaygın olarak kullanılmaktadır. Şekil parametresinin aldığı değerlere bağlı olarak bazı durumlarda Rayleigh ve üssel dağılımlara da sahip olan Weibull dağılımı, bozulma oranları ile ilgili veri seti için kurulacak modellerde yaygın olarak kullanılmaktadır. Birçok durumda, üssel dağılımın zamana karşı dayanma modeli olarak yetersiz kalması, sabit bozulma oranından kaynaklanır. Bu nedenle bozulma olasılığının zamana bağlı olarak değiştiği daha genel ve esnek bir dağılıma yani Weibull dağılımına gereksinim duyulur. Weibull dağılımının zamana karşı dayanma modeli olarak kullanıldığı uygulama alanlarına örnek olarak elektron tüpleri, röleler ve bilyalı rulman gösterilebilir (Hahn & Shapiro, 1967). Weibull dağılımı endüstriyel mühendislik problemlerinde imalat ve dağıtım zamanlarının gösterimi için kullanıldığı gibi, uç değer teorisinde ve hava tahmininde önemlidir. Güvenilirlik mühendisliğinde ve hata analizinde çok popüler bir modeldir. Radar sisteminde, alınan sinyal seviyelerinin dağılımını modellemek için kullanılır. Ayrıca telsiz iletişimi ile ilgili sönümlü kanal modellemesi için ve rüzgâr hızı dağılımlarını tanımlamak için

kullanılır.

Weibull dağılımı sürekli ve aynı zamanda esnek bir dağılımdır ve birçok uygulamada teorik olarak uygun çözümler sağlar. Weibull dağılımı genel olarak ölçek ve biçim parametresi olmak üzere iki parametrelili bir dağılımdır. İki parametrelili Weibull olasılık yoğunluk fonksiyonu;

$$f(t)=\beta\eta(t\eta)^{\beta-1}\exp[-(t\eta)^\beta]$$

Şeklinde tanımlanmaktadır. Burada  $\beta$  şekil parametresi,  $\eta$  ise ölçek parametresi olup,  $f(t) \geq 0$ ,  $t \geq 0$ ,  $\beta > 0$ ,  $\eta > 0$ 'dır.

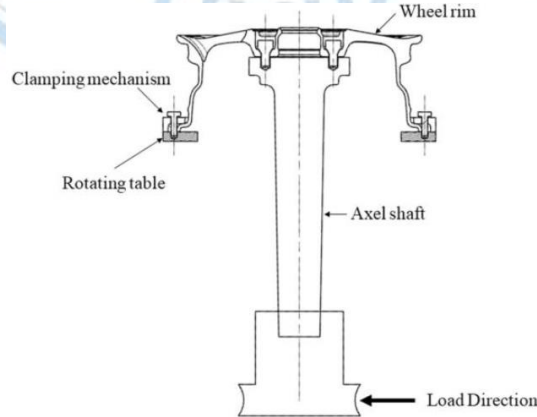
#### Hızlandırılmış Ömür Testleri

Genel olarak, güvenilirlik tahmin modelleri, stres koşulları altında bozulma verilerini kullanmakla ilgilenir. Hızlandırılmış ömür testi, kısa bir zaman aralığındaki bozulmaları ve potansiyel bozulma modlarını ortaya çıkarmak için bir bileşenin normal kullanım koşullarını aşan parametrelere (yük, sıcaklık, voltaj, titreşim oranı, basınç vb.) tabi tutarak test edilmesini sürecidir. Bu testlerin amacı, normal kullanım koşullarında bileşen ömrü veya performansı hakkında istenen bilgileri üreten, doğru bir şekilde modellenip analiz edilen verileri hızlı bir şekilde elde etmektir. Hızlandırılmış ömür testinde elde edilen verileri modellemede en çok kullanılan modeller Arrhenius, Eyring ve Ters Kuvvet Kanunu modelleridir (Pham, 2003).

Ters Kuvvet Kanunu (Power Law) Modeli: Malzeme yıprandıkça veya deforme olduğunda, malzemenin özelliklerindeki değişimi ifade eden bir modeldir. Ters kuvvet kanunu, belirli bir özellik ile ilgili bir sürecin hızını ifade eden bir potansiyel denklemi temel alır. Çeşitli malzemelerin yorulma, aşınma ve çürüme gibi süreçlerinin modellenmesinde kullanılır. Ters kuvvet ilişkisi termal olmayan durumlarda geniş çaplı olarak kullanılan hızlandırılmış yaşam modelidir. Genellikle voltaj, basınç ve nem stres etkileri için kullanılır. Ters kuvvet kanunu, diğer stres seviyeleri sabit tutulduğunda özellikle basınç benzeri stresler için bileşen veya sistemin yaşam zamanı ile hızlandırma stres faktörünün arasında iyi bir model oluşturur.

#### Jantlar İçin Dinamik Viraj Yorulması Testi

Dinamik viraj yorulması testi, bir aracın viraja girmesi durumunda aracın maruz kaldığı merkezkaç kuvveti sebebiyle jant üzerinde meydana gelen momentin bir test tezgâhı ile laboratuvar ortamında jant üzerinde oluşturulmasını hedef alır. Jant, iç flanş bölgesinden test tezgahına sabitlenir. Tezgâha iç flanş bölgesinden sabitlenen jant, araç üzerinde jantın porya ile montajlandığı göbek bölgesinden bir mile montajlanır. Göbek bölgesine montajlanan milin uç noktasına kuvvet uygulanarak jant üzerinde deformasyon meydana getirilir. Milin ucuna çevrimsel şekilde uygulanan yük, jantın araç üzerindeki kullanımı esnasında maruz kaldığı çevrimsel yükleri temsil eder. (Şekil 1, SAE J328 (2001))



Şekil 1. Dinamik viraj yorulması test cihazı şematik gösterimi

Farklı stres seviyelerinde çeşitli güvenilirlik ve ömür değerlerini özetlenmektedir. 450,000 döngü için güvenilirlik değerleri 125 stres seviyesinde 0.268104, 140 stres seviyesinde  $9.046E^{-31}$ , 165 stres seviyesinde  $1E^{-99}$  ve günlük kullanım koşulu tahmini 0.985027 olarak belirtilmiştir. 450,000 döngüde çalışmasına ait güvenilirlik değerleri ise 125 stres seviyesinde 0.731839, 140 ve 165 stres seviyelerinde 1, günlük kullanım koşulu tahmini 0.014973 olarak görülmektedir. 50,000 döngü tamamlandıktan sonra 100,000 döngüye kadar olan güvenilirlik 125 stres seviyesinde 0.999539, 140 stres seviyesinde 0.976035, 165 stres seviyesinde 0.000514 ve günlük kullanım koşulu tahmini 0.999995 olarak verilmiştir.

%99 güvenilirlikle 125 stres seviyesinde 225,845 döngü, 140 stres seviyesinde 130,678 döngü, 165 stres seviyesinde 59,118 döngü ve günlük kullanım koşulu tahmini 418,629 döngü olarak gösterilmiştir. %5 başarısızlık ömrü 125 stres seviyesinde 287,468 döngü, 140 stres seviyesinde 166,334 döngü, 165 stres seviyesinde 75,249 döngü ve günlük kullanım koşulu tahmini 532,853 döngü olarak belirtilmiştir. Ortalama ömür 125 stres seviyesinde 405,975 döngü, 140 stres seviyesinde 234,905 döngü, 165 stres seviyesinde 106,270 döngüdür. Günlük kullanım koşulu tahmini 932,044 döngü olarak görülmektedir. 450,000 döngü tamamladıktan sonra kalan ortalama ömür 125 stres seviyesinde 32,289 döngü, 140 stres seviyesinde 887 döngü, 165 stres seviyesinde 2 döngüdür ve günlük kullanım koşulu tahmini 482,044 döngü olarak verilmiştir. 450,000 döngüdeki arıza oranı 125 stres seviyesinde 0.000021, 140 stres seviyesinde 0.001113, 165 stres seviyesinde 0.347586 ve günlük kullanım koşulu tahmini  $1.2798E^{-28}$  olarak belirtilmiştir. Günlük kullanım koşulları ile kıyaslandığında hızlandırma faktörü, 125 stres seviyesinde 1.8536, 140 stres seviyesinde 3.2035, 165 stres seviyesinde 7.0811 kat jantların ömrünü daha hızlı tamamladığı görülmektedir. Bu değerler, farklı stres seviyelerinde sistemin güvenilirlik ve ömür performansını değerlendirmek için kullanılmıştır.

## SONUÇLAR

Dinamik viraj yorulma testlerinden elde edilen sonuçlar, A356 alaşımı kullanılarak üretilen alüminyum alaşımlı jantların güvenilirliği hakkında önemli bilgiler sağlamıştır. Testler, jantların farklı gerilme seviyelerinde nasıl performans gösterdiğini belirlemiştir.

Stres-Ömür (S-N) Eğrileri: S-N eğrileri, uygulanan gerilme ile arıza oluşana kadar geçen çevrim sayısı arasındaki ilişkiyi göstermiştir. Daha yüksek gerilme seviyelerinin, arıza oluşmadan önce dayanılan çevrim sayısını azalttığı gözlemlenmiştir. Bu ters ilişki, jantların farklı çalışma koşullarındaki dayanıklılığını anlamak açısından kritik öneme sahiptir.

Güvenilirlik Analizi: Weibull analizi, jantların uygulanan gerilme seviyelerine göre ortalama ömürlerinin önemli ölçüde değiştiğini göstermiştir. Örneğin, 110 gerilme seviyesinde jantların ortalama kalan ömrü 450,000 çevrimden sonra 482,044 çevrim olarak tahmin edilmiştir. Bu, daha düşük gerilme seviyelerinde jantların yüksek güvenilirlik gösterdiğini ortaya koymaktadır.

Güvenilirlik Olasılığı: Farklı gerilme seviyeleri için jantların güvenilirlik olasılığı da hesaplanmıştır. Örneğin, 450,000 çevrimde jantların 110 gerilme seviyesindeki güvenilirliği yaklaşık olarak 0.99 olarak bulunmuş, bu da jantların bu çevrim sayısını arızasız geçirme olasılığının yüksek olduğunu göstermektedir.

BX% Ömrü: BX% ömrü değerleri (X, arızalanması beklenen birimlerin yüzdesini temsil eder) belirlenmiş ve normal kullanım koşullarında jantların beklenen ömrü hakkında kritik bilgiler sağlamıştır. Örneğin, B1% ömrü (jantların %1'inin arızalanması beklenen süre) 780,535 çevrim, B10% ömrü ise 848,425 çevrim olarak belirlenmiştir.

Sonuç olarak, bu çalışma A356 alaşımı kullanılarak üretilen alüminyum alaşımlı jantların güvenilirliği ve performansı hakkında kapsamlı bir değerlendirme sunmaktadır. Bulgular, stres-ömür ilişkisini anlamının önemini vurgulamakta ve otomotiv endüstrisinde jant tasarımı ve üretim süreçlerini geliştirmek için değerli veriler sağlamaktadır.



### Kaynakça

- Kocabicak, U., & Firat, M. (2001). Numerical analysis of wheel cornering fatigue tests. *Engineering Failure Analysis*, 8(4), 339-354.
- Wang, X., & Zhang, X. (2010). Simulation of dynamic cornering fatigue test of a steel passenger car wheel. *International journal of fatigue*, 32(2), 434-442.
- Li, P., Maijer, D. M., Lindley, T. C., & Lee, P. D. (2007). A through process model of the impact of in-service loading, residual stress, and microstructure on the final fatigue life of an A356 automotive wheel. *Materials Science and engineering: A*, 460, 20-30.
- Shang, R., Altenhof, W., Hu, H., & Li, N. (2009). Rotary fatigue analysis of forged magnesium road wheels. *SAE International Journal of Materials and Manufacturing*, 1(1), 9-15.
- Raju, P. R., Satyanarayana, B., Ramji, K., & Babu, K. S. (2007). Evaluation of fatigue life of aluminum alloy wheels under radial loads. *Engineering failure analysis*, 14(5), 791-800.
- Ballo, F., Frizzi, R., Mastinu, G., Mastroberti, D., Previati, G., & Sorlini, C. (2016). Lightweight design and construction of aluminum wheels. *SAE technical paper*, 1-9.
- Tebaldini, M., Petrogalli, C., Donzella, G., & La Vecchia, G. M. (2017). Estimation of fatigue limit of a A356-T6 automotive wheel in presence of defects. *Procedia Structural Integrity*, 7, 521-529.
- Koran, L. (2017). Jantlar için dinamik viraj yorulma test makinası tasarlanması-üretilmesi ve testlerin yapılması (Master's thesis, Adnan Menderes Üniversitesi, Fen Bilimleri Enstitüsü).
- Koppiseti, S. B., Nallu, R., & Penmetsa, R. R. (2022). Passenger Cars Wheel Performance Test Simulation for Service Life Evaluation: A Review. *Journal of Failure Analysis and Prevention*, 22(4), 1370-1392.
- Hahn G. J. & Shapiro S. S. (1967). *Statistical models in engineering*. Wiley.
- Pham, H. (2003). *Handbook of Reliability Engineering*. Springer-Verlag London.

### Teşekkürler

Proje kapsamında CMS Jant ve Makina San. A.Ş.'ye, proje süresince bize rehberlik eden, katkıda bulunan ve destek olan Prof.Dr. Selma Gürler'e ve projemizin firma danışmanı olarak bizleri yönlendiren Kıdemli Ar-Ge Uzmanı Meriç Işık'a ve ekip arkadaşlarım Alper Arslan, Deniz Elibol'a teşekkür ederim.

### Çıkar Çatışması

Yazarların çıkar çatışması olmadığı beyan edilmiştir.

## Sample Size in Confirmatory Factor Analysis: Monte Carlo Simulation Study

**Murat YILDIRIM**<sup>1</sup>

<sup>1</sup>*Tokat Gaziosmanpasa University, Faculty of Economics and Administrative Sciences, Department of Business Administration, 60000, Tokat, Türkiye*

\*Corresponding Author e-mail: [murat.myildirim@gop.edu.tr](mailto:murat.myildirim@gop.edu.tr)

### **Abstract**

A common problem for researchers is determining the required sample size for the study. Although practical rules and recommendations on this subject have been developed over the long term, there is no general rule that can be applied in practice for every situation. Determining the sample size depends on many factors such as the number of parameters included in the model, the distribution of variables and missing data. Estimates in each study are affected by these factors. There are always small biases in parameter estimates and their standard error estimates. The important issue here is that standard error biases are quite sensitive. Because with an overestimated standard error, an effect that is actually important may be considered insignificant. If the opposite happens, a significant effect may be greatly exaggerated. Therefore, an important issue for sample size is power. Although the sample size is large enough to provide unbiased estimates and also confidence intervals, it may not be large enough to test for a significant effect in the model. Therefore, the aim of this study is to determine the sufficient sample size for a determined model, considering power and other criteria. In order to achieve this aim, Monte Carlo simulation was carried out using the Mplus 7 program. The model determined in the study is the confirmatory factor analysis model. The reason for this choice is due to the publication of important research on the number of factors or structure of a scale developed or adapted to another language. The model inspired for this study is the model of the multidimensional perceived social support scale. After model selection, population values and factor loadings were considered as 0.65, 0.70 and 0.60, starting from the first factor. Additionally, the variance of the residuals was chosen as 0.3, factor variances as 1.0, and factor correlations as 0.6, 0.25 and 0.40. In the sample size decision-making strategy, the parameter and standard error biases were chosen not to exceed 0.10, the focal parameter biases were not greater than 0.05, the coverage value was between 0.91 and 0.98, and the power value was 0.80, based on the literature. The sample size for the determined model started with 60, which can be considered a small sample size. However, as expected, convergence did not occur in the sample size of 60. Following the failure of the sample size of 60, a sample size of 120 was determined, but in this model, the desired power for the focal parameters was not reached. Later, two samples of first 150 units and then 180 units were taken, with an increment of 30 each. The sample size that met all the specified criteria was determined as 180. It would be very useful to repeat this Monte Carlo study under conditions such as non-normal or missing data and also consider the fit index results.

**Keywords:** Monte Carlo Simulation Study, Minimum Sample Size, Confirmatory Factor Analysis

### **INTRODUCTION**

Structural Equation Model (SEM) is one of the leading methods in examining and establishing important theories in many branches of science, including social and behavioral sciences. A significant part of the studies on SEM focus on Confirmatory Factor Analysis (CFA). CFA plays an important role in revealing the use of recommended scales for concepts that are theoretically determined but whose measurement is not yet clear. A common question asked by many researchers about the use of scales developed or translated into a different language is how much sample size is required. It is observed that there are quite different suggestions in the literature when determining the sample size. For example, there are

many different suggestions such as 5 or 10 times the number of free parameters, a volume of 200-400, a volume of more than 100, 50 observations per variable. This result shows that there is no rule that will be valid for every study (Bayram, 2016; Bentler and Chou, 1987; Jackson, 2001; Schumacker and Lomax, 2004).

The sample size required in a model study; It depends on many factors such as the distribution of the variables, the number of parameters the model has, the amount of missing data, the strength of the focal relationship between the variables, and whether the measurements of the variables are reliable or not. It is also quite possible that there is a small bias in the parameter estimates. What is very sensitive to this situation are standard errors. Bias in estimating standard errors highlights issues such as overestimation or underestimation. This affects the estimation of the extent, in other words the confidence interval. An overestimation of the standard error may cause important relationships to be missed. If underestimated, important relationships will be overestimated. Considering this issue, another important criterion for sample size is difficulty. The sample size, unbiased parameter and standard error estimates used in a study may be sufficient for a good confidence interval, but may not be sufficient to detect the focal relationship that caused the study to be conducted (Muthen and Muthen, 2002).

The aim of this study is to explain the sufficient/minimum sample size for a determined CFA model with Monte Carlo simulation, considering power and other criteria. It was intended to conduct a research on scales where CFA is of critical importance in model determination. Because there are significant debates about the factor structure and number of scales developed or translated into a different language. Therefore, in order to make important inferences about these scales, the sample size must first be determined correctly. The form structure of the Multidimensional Perceived Social Support Scale (MDPSS), which has been discussed in both national and international literature (Cheng and Chan, 2004; Chou 2000; Eker et al., 2001; Eker and Akar, 1995a; Eker and Akar, 1995b), is the CFA model of the study. Monte Carlo simulation was carried out using the Mplus 7 program. Three sections were created for the study. These are the method, findings and results-discussion sections.

## MATERIALS AND METHODS

### Material

The model used in the study has a 3-factor structure and each factor has four observed variables. Assignments for the model's population values were determined using previous studies and theory. Factor load values were assigned as 0.65, 0.70, 0.60, respectively. In addition, the variance of the residuals was determined as 0.3, factor variances were determined as 1.0, and factor correlations were determined as 0.6, 0.25 and 0.40. The path diagram of the model is given in Figure 1.

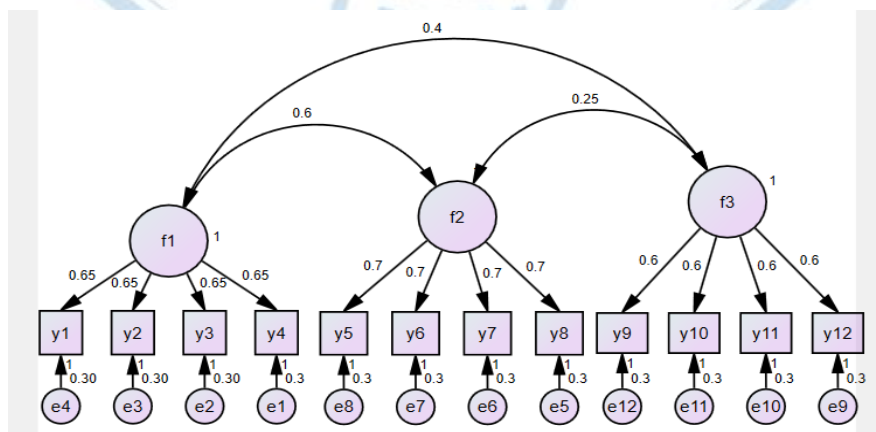


Figure 1. Path Diagram of the Model



## Methods

The common use of Monte Carlo simulation studies is to measure the performance of one or more estimators under various conditions. For performance measurements of estimators, first the data of the model is produced and the estimation process of the model is carried out. Afterwards, parameter estimation bias, standard error bias and confidence interval criteria are discussed. Very little use for Monte Carlo studies; is to decide on the required sample size and determine the power in the study. This usage is the focus of this study (Muthen and Muthen, 2002).

### *Monte Carlo Simulation Study*

In the Monte Carlo simulation study, data is generated based on the parameter values determined for the population. In general, a large number of sample data are generated. Estimates of parameters and standard errors are obtained through sample means. The evaluation is the parameter and standard error biases as well as the confidence interval. The first thing to do for the simulation study is to determine the model and assign the population parameter values. If this assignment process has been assigned using previous studies, these are the best estimates for the simulation study. Technical issues in the simulation study are the sample volume to be copied and the initial values to be used in data generation. The number of copies is generally assigned using a larger number such as 10,000 for clarity. The same copy number was used in this study. The description for the initial values is called the seed word. It is important for research to obtain clarity, that is, stability, in the results by using different seeds in the sample to be drawn (Muthen and Muthen, 2002). Different starting values were not used in this study.

### *Strategies for Deciding on Sample Size*

- The strategy used in this section is given below.
- Bias of parameters and standard errors should not be more than 10%.
- Deviations of standard errors for specific focal parameters should not be greater than 5%.
- Coverage value should be between 0.91 - 0.98.
- Power must be at least 0.80.

The criteria mentioned here were determined with the help of the relevant literature (Bandalos 2006; Muthen and Muthen, 2002). The focal parameters for the study are the correlation between factors.

### *Estimation of the Model*

The estimation of the model used in the study was carried out with the Maximum Likelihood ML estimator under the condition that the normality assumption was met and there was no missing data. The program used is Mplus 7.

## RESULTS

Recommendations in the literature regarding sample size experiments, which should not be taken as a general rule, were taken into consideration. Therefore, firstly, a volume of 100 units, which is described as a small sample size in the literature, was considered. However, simulation studies conducted when a sample volume of less than 100 units was used, such as 50 units, found that convergence problems were encountered (Anderson and Gerbing, 1984). Therefore, it was first determined as  $n=60$ . The results obtained were similar to the literature, and in addition to convergence, the Heywood Case was also encountered. After  $n=60$  selections, the trial was conducted with a sample size of  $n=120$  units, slightly exceeding 100 units. Since the power values for the focal parameters were not reached in this trial, the next trial volumes were  $n = 150$  and  $n = 180$ , respectively, with an increase of 30. In the model with  $n=150$  units, the focal parameters could not reach the desired power values. The model with  $n=180$  units met all sampling and determination strategies.

**V. INTERNATIONAL APPLIED STATISTICS CONGRESS (UYIK - 2024)**  
**İstanbul / Türkiye, May 21-23, 2024**

As a result, there were a total of 4 models tried to determine the minimum sample size. The results in which the first 3 models did not meet the criteria for the findings are given in Table 1. The findings of the final model are given in Table 2.

Table 1. Findings in Models with a Sample Volume of n=60,120 and 150 Units

N=60		Population	ESTIMATES Average	Std. Dev.	S. E. Average	M. S. E.	%95 Cover	%Sig Coeff
F1	WITH							
F2		0.600	0.5962	0.1103	0.1047	0.0122	0.926	0.993
F3		0.400	0.3961	0.1391	0.1324	0.0194	0.926	0.792
F2	WITH							
F3		0.250	0.2481	0.1498	0.1423	0.0224	0.926	0.433
REPLICATION 3755: WARNING: THE RESIDUAL COVARIANCE MATRIX (THETA) IS NOT POSITIVE DEFINITE.								
N=120								
F1	WITH							
F2		0.600	0.5987	0.0772	0.0741	0.0060	0.931	1.000
F3		0.400	0.3988	0.0965	0.0941	0.0093	0.937	0.968
F2	WITH							
F3		0.250	0.2492	0.1036	0.1015	0.0107	0.939	0.671
N=150								
F1	WITH							
F2		0.600	0.5995	0.0682	0.0662	0.0047	0.935	1.000
F3		0.400	0.3992	0.0855	0.0843	0.0073	0.941	0.989
F2	WITH							
F3		0.250	0.2494	0.0923	0.0909	0.0085	0.941	0.759

Explanations for the columns in Table 1 are as follows. The first column contains the assigned values for the population parameter values. The second column gives the average of the parameter estimates obtained from the replicates as a result of the Monte Carlo study. For example, in the first column, the correlation between F1 and F2 was assigned as 0.60, but the average estimate was obtained as 0.5962 at n = 60. In this case, bias calculation can be made. For example, if the value 0.60 is subtracted from 0.5962 and divided by 0.60, the bias is calculated. The third column gives the standard deviation of each parameter estimate, since the number of replicates is very large, such as 10,000, and the standard deviation expression is used instead of the population standard error. The fourth column gives the average of the estimated standard errors for each parameter estimate over replicates of the Monte Carlo run. The standard error deviation is calculated in the same way as the deviation of the parameter estimate.

M.S.E. The fifth column labeled gives the mean square error of each parameter. M.S.E. The calculation is equal to the variance of the parameter estimates plus the square of the deviations. For example, M.S.E. in the first line. The value is calculated as  $(0.6 - 0.5962)^2 + 0.1103^2 \cong 0.0122$ . The sixth 95% cover column gives the proportion of replicates containing population parameter values. The last column is used to evaluate the power criterion. This column, labeled %Sig Coeff, examines whether each parameter is significant at the 5% significance level. In other words, hypothesis testing deals with whether the value of each parameter is equal to zero. The result of this interest is given as the proportion of replicates that reject the null hypothesis. In the null hypothesis, the value of the parameters is set to be equal to zero. Here, the power of the test is the probability of rejecting the null hypothesis when it is false. Typically, its expression is  $1 - \beta$ .

When Table 1 is examined, all parameter results of the models are not included. The reason for this

is that the findings take up a lot of space and because the criteria required for the focal parameters are generally quite poor, only the focal parameters are included in this table. In the sample size of  $n=60$ , the problem of the covariance matrix of the residuals not being positive is observed. In other models with  $n=120,150$  units, the focal parameters did not reach the desired power values.

The findings of the last model, the  $n=180$  unit model, are presented in Table 2 with the help of a different table.

Table 2. Findings of the Model with a Sample Volume of  $n=180$  Units

N=180		Population	ESTIMATES Average	Std. Dev.	S. E. Average	M. S. E.	%95 Cover	%Sig Coeff
F1	WITH							
F2		0.600	0.600	0.0630	0.0604	0.0040	0.936	1.000
F3		0.400	0.3993	0.0784	0.0770	0.0062	0.943	0.996
F2	WITH							
F3		0.250	0.2496	0.0842	0.0830	0.0071	0.945	0.827

Table 2 data provides the full sampling strategies for the focal parameters. A similar situation applies to the parameters whose values are assigned for the population. Such a use was preferred so that they do not take up too much space.

## DISCUSSION AND CONCLUSION

The aim of the studies carried out to determine the minimum/sufficient sample volume is to provide answers to important issues such as eliminating convergence problems and obtaining unbiased parameter and standard error estimates. The significance tests of the sample size are checked with general fit and likelihood ratio tests. In this case, the significance test is concerned with the adequacy of the proposed sample size in achieving a certain power for the criteria. However, the significance test is best solved by power analysis for certain situations. For example, one can review “Power Analysis for SEM: A Few Factsheets” (Hancock, 2013; Lee, Cai, and MacCallum, 2012).

Although there is no clarity in the literature on determining the sample size, there are different recommendations. In general, for a SEM study, a sample size of less than 100 is classified as a small sample, 100-200 as a medium sample, and more than 200 as a large sample. While a sample size of 200-400 is recommended for models with 10-15 indicator variables, some researchers have recommended a sample size of 100-200. Schumacker and Lomax (2004) stated that a sample size of 250-500 was used in many studies. Some rules of thumb for sample size are also suggested. For example; The number of indicator variables should be 8 times or more, Stevens (1996), each variable should have 15 units, the sample size should be  $p(p+1)/2$ , where  $p$  is the number of variables (Bayram, 2016). It is also recommended to have a sample size of 5 or 10 times the number of free parameters (Bentler and Chou, 1987; Jackson, 2001). These recommendations indicate that there is no general rule for every model (Kyriazos, 2018). Under certain conditions, simulation studies for sufficient sample size provide the best answer with the power criterion. For this reason, in this study, the CFA model, which is frequently used in SEM studies, was discussed within the framework of MSPSDS. The minimum sample volume was evaluated in terms of specified criteria with a Monte Carlo simulation study under certain conditions.

There are many problems when considering minimum sample size. There are simulation studies showing that the model fails to converge when the minimum sample size recommendation is 100 and the sample size is 50 (e.g., Anderson and Gerbing, 1984). In this study, a convergence problem was experienced when the sample size was 60. The ratio of cases to free parameters, or  $N:q$ , sometimes expressed as indicators in the context of CFA, is often used for minimum recommendations, but may not be as important as other factors such as overall sample size ( $> 200-400$ ) and magnitude of loadings (e.g. standard value  $> 0.60$ ) these may be more important (Jackson, 2003). Although even a 10:1 ratio is considered safe most of the time, simulation work by Nevitt and Hancock (2004) suggests that there



are some situations where this is not sufficient. Similar findings were obtained in this study. Additionally, Wolf, Harrington, Clark, and Miller (2013) showed that having more indicators per factor generally results in a smaller required sample size rather than a larger required sample size (Kyriazos, 2018; Newsom, 2018).

It should be noted that simulation studies are rough estimates based on the recommendations of the researcher who performed them, and they may not be equally valid in all circumstances and should not be taken as definitive information. Simulation studies can examine only a few conditions at a time and often involve simplified conditions compared to real practice. These recommended sample sizes are based on ML estimation with multivariate normal data and accurately specified models, which can be quite rare in practice (Newsom, 2018). Therefore, when deciding on the minimum sample size required for researchers' studies, researchers should consider a larger sample size than the recommendations of simulation studies. The reason for this situation is the attitude of absolute (RMSEA, Chi-square) fit indices and other fit indices towards normality and sample sizes. For example, while the Chi-square fit measure gives unrealistic results by taking larger values as the sample size increases under the assumption of multivariate normality, it is not affected much by the growth of the sample size in cases where there is no normality assumption (Doğan, 2013).

Considering the study findings and literature summaries, retesting with non-normal distribution and missing data under similar sampling strategies will make significant contributions to real applications.

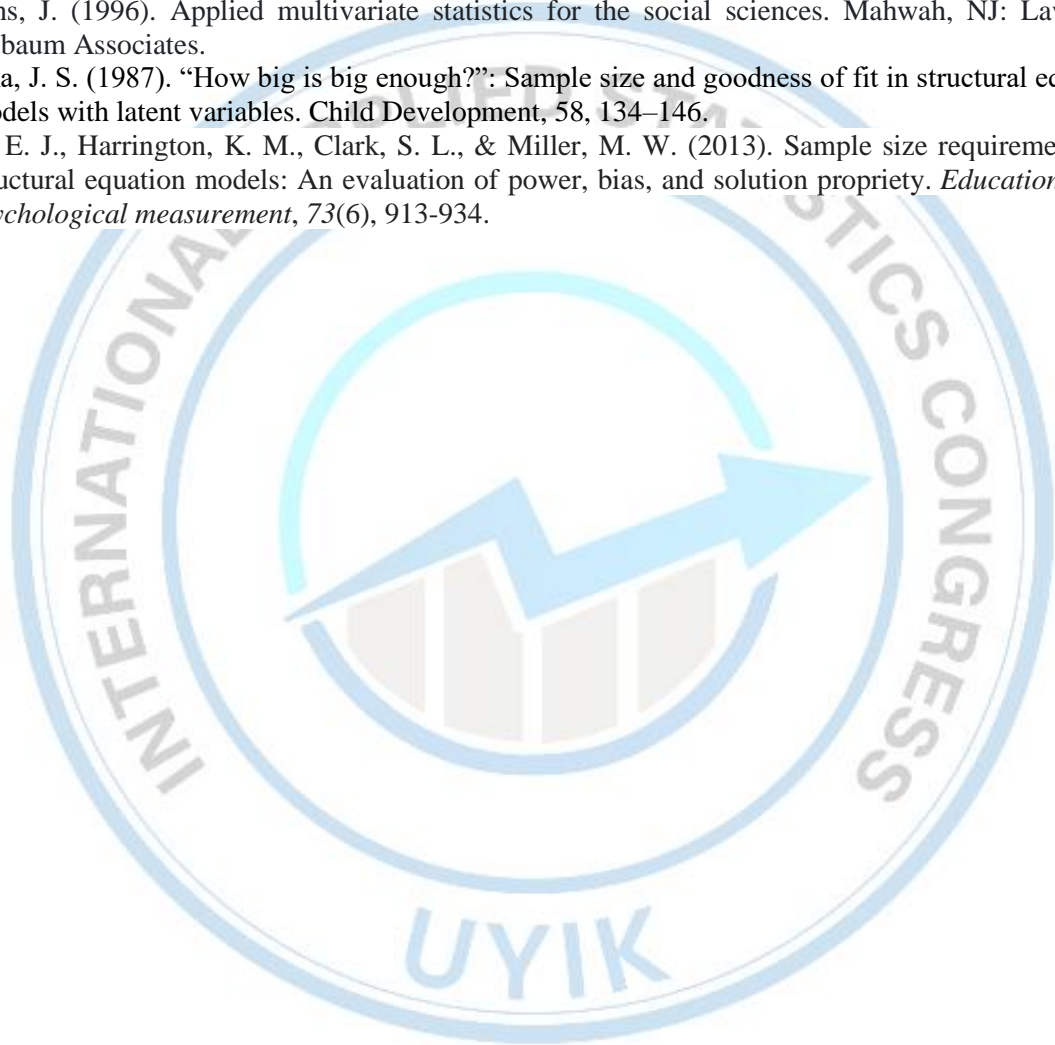
## References

- Anderson, J. C., & Gerbing, D.W. (1984). The effect of sampling error on convergence, improper solutions, and goodness-of-fit indices for maximum likelihood confirmatory factor analysis. *Psychometrika*, 49, 155–173.
- Bandalos, D. L. (2006). The use of Monte Carlo studies in structural equation modeling research. In R. C. Serlin (Series Ed.), G. R. Hancock, ve R. O. Mueller (Vol. Eds.), *Structural equation modeling: A second course* (s. 385–462). Greenwich, CT: Informa-tion Age.
- Bayram, N. (2016). *Yapısal Eşitlik Modellemesine Giriş AMOS Uygulamaları*. Ezgi Kitapevi Yayınları, Bursa.
- Bentler, P. M., & Chou, C.-P. (1987). Practical issues in structural equation modeling. *Sociological Methods and Research*, 16, 78–117.
- Cheng, S. T., & Chan, A. C. (2004). The multidimensional scale of perceived social support: dimensionality and age and gender differences in adolescents. *Personality and individual differences*, 37(7), 1359-1369.
- Chou, K.-L. (2000). Assessing Chinese adolescents social support: the multidimensional scale of perceived social support. *Personality and Individual Differences*, 28, 299–307.
- Doğan M, 2013. Doğrulayıcı faktör analizinde örneklem hacmi, tahmin yöntemleri ve normalliğin uyum ölçütlerine etkisi. Master Thesis, Eskişehir Osmangazi University, Eskişehir, Türkiye.
- Eker D, Arkar H (1995a) Perceived social support: psychometric properties of the MSPSS in normal and pathological groups in a developing country. *Soc Psychiatry Psychiatric Epidemiol*, 30:121-126.
- Eker D, Arkar H (1995b) Çokboyutlu Algılanan Sosyal Destek Ölçeği'nin faktör yapısı, geçerlik ve güvenilirliği. *Türk Psikoloji Dergisi*, 34:45-55.
- Eker, D., Arkar, H., & Yıldız, H. (2001). Çok Boyutlu Algılanan Sosyal Destek Ölçeği'nin gözden geçirilmiş formunun faktör yapısı, geçerlik ve güvenilirliği. *Türk Psikiyatri Dergisi*, 12, 17–25.
- Hancock, G.R. (2013). Power analysis in structural equation modeling. In G.R. Hancock & R.O. Mueller (Eds.), *Structural Equation Modeling: A second Course*, 2nd Edition (pp.117 -162). Charlotte, NC: Information Age Publishing.
- Jackson, D. L. (2001). Sample size and number of parameter estimates in maximum likelihood confirmatory factor analysis: A Monte Carlo investigation. *Structural Equation Modeling*, 8, 205–223.
- Jackson, D. L. (2003). Revisiting sample size and the number of parameter estimates: Some support for the N:q hypothesis. *Structural Equation Modeling*, 10, 128–141.
- Kyriazos, T. (2018) *Applied Psychometrics: Sample Size and Sample Power Considerations in Factor*

**V. INTERNATIONAL APPLIED STATISTICS CONGRESS (UYIK - 2024)**  
**İstanbul / Türkiye, May 21-23, 2024**

---

- Analysis (EFA, CFA) and SEM in General. *Psychology*, **9**, 2207-2230.
- Lee, T., Cai, L., & MacCallum, R.C. (2012). Power analysis for tests of structural equation modeling. In Hoyle, R. H. (Ed.). *Handbook of structural equation modeling* (pp. 181-194). New York: Guilford Press.
- Muthen, L. ve Muthen, B.O., (2002). "How To Use A Monte Carlo Study To Decide on Sample Size and Determine Power, Structural Equation Modeling", *A Multidisciplinary Journal*, 9(4): 599-620.
- Nevitt, J., & Hancock, G. R. (2004). Evaluating small sample approaches for model test statistics in structural equation modeling. *Multivariate Behavioral Research*, 39(3), 439-478.
- Newsom, J. T. (2018). *Minimum Sample Size Recommendations (Psy 523/623 Structural Equation Modeling, Spring 2018)*. Manuscript Retrieved from.
- Schumacker, R. E., & Lomax, R. G. (2004). *A beginner's guide to structural equation modeling*. psychology press.
- Stevens, J. (1996). *Applied multivariate statistics for the social sciences*. Mahwah, NJ: Lawrence Erlbaum Associates.
- Tanaka, J. S. (1987). "How big is big enough?": Sample size and goodness of fit in structural equation models with latent variables. *Child Development*, 58, 134-146.
- Wolf, E. J., Harrington, K. M., Clark, S. L., & Miller, M. W. (2013). Sample size requirements for structural equation models: An evaluation of power, bias, and solution propriety. *Educational and psychological measurement*, 73(6), 913-934.



**A Dynamic Model Proposal for the Solution of a Multi-Period Multi-Criteria Decision-Making Problem: An Application with LOPCOW-MCRAT Integrated Method**

**Pembe Güçlü**<sup>1\*</sup>

<sup>1</sup>Çankırı Karatekin University, Faculty of Economics and Administrative Sciences, Department of Business Administration, 18100, Çankırı, Türkiye

\*Corresponding author e-mail: pembeguclu@karatekin.edu.tr

***Abstract***

*Multi-criteria decision-making (MCDM) is a significant sub-discipline of decision science. It encompasses approaches and methodologies that aim to identify the optimal solution that simultaneously satisfies multiple conflicting criteria. While traditional MCDM methods typically utilize data from a single period, this study presents a dynamic framework incorporating data from multiple periods. The primary distinction between the proposed dynamic model and traditional static multi-criteria decision-making models is the establishment of interdependence between successive periods by creating a transition element between these periods. The proposed approach is applied to a hypothetical business performance evaluation example using the LOPCOW-MCRAT hybrid method and supported by comparative analyses.*

**Keywords:** *Dynamic MCDM, LOPCOW, MCRAT, Business Performance*

**INTRODUCTION**

Traditional or fixed multi-criteria decision-making (MCDM) models evaluate according to set criteria and options within a specified period. This method, however, limits decision accuracy, especially for considerations spanning medium to long terms, by neglecting variability and input. Static MCDM results might be inadequate or flawed due to the absence of past and future data integration. In contrast, Dynamic multi-criteria decision-making (DMCDM) is a technique utilized in decision-making procedures where options and criteria transform progressively and time-dependent (Campanella & Ribeiro, 2011; Jassbi et al., 2014; Nejatnia et al., 2023). Dynamic MCDM merges historical records with current data, enhancing the currency and quality of decisions (Campanella & Ribeiro, 2011). Therefore, dynamic MCDM provides a more adaptable and all-encompassing decision-making process by adapting to evolving circumstances, a vital aspect of tactical and strategic decision-making (Jassbi et al., 2014).

DMCDM was initially introduced by Kornbluth in 1992. Subsequent years saw various theoretical and practical studies (e.g. Townsend and Busemeyer, 1995; Vo et al., 2002; Gonzales, 2005; Saaty, 2007; Lin et al., 2008; Pais & Ribeiro, 2009; Busemeyer & Pleskac, 2009) enrich the DMCDM literature. Campanella and Ribeiro's 2011 study has become a pivotal work in this field. DMCDM methodologies often rely on data gathered across diverse time frames. However, they may encounter difficulties when dealing with extensive options or evolving criteria. The model proposed by Campanella and Ribeiro (2011) offers a remedy for this challenge by introducing a dynamic feedback mechanism.

The critical phase in Campanella and Ribeiro's (2011) DMCDM framework is selecting the right aggregation operator for dynamic ratings. Operator choice impacts scores and results. Associativity can lead to identical ratings despite performance differences (Zulueta et al. 2013). In this study, a dynamic multi-criteria decision making model without the need for aggregation operator is proposed. The performance of the proposed model is tested with a hypothetical business performance problem.



**MATERIAL AND METHODS**

**Material**

The decision problem in applying the proposed method is evaluating five alternative enterprises' performance (A, B, C, D, and E) over four years (t, t+1, t+2, t+3) using twelve criteria. The criteria and their definitions are shown in Table 1.

Table 1. Criteria of Business Performance Problem

<b>Code</b>	<b>Criterion</b>	<b>Definition</b>	<b>Cost/Benefit</b>
C1	Labour Productivity	The quantity of product produced per worker.	Benefit
C2	Energy Consumption	The total energy required for a given alternative is expressed in kilowatt-hours (kWh).	Cost
C3	Waste Amount	The total quantity of waste generated and stored by the alternative business (tonnes)	Cost
C4	CO2 Emission	The quantity of carbon dioxide emitted by a business on an annual basis (Tonnes)	Cost
C5	Supply Chain Performance	The extended supply chain's efforts in fulfilling end-customer needs. This includes product availability, timely delivery, and essential inventory and capacity to ensure responsive performance delivery (Hausman, 2004). (0-100)	Benefit
C6	Quality Score	The delivery of a product or service that meets the established standards and expectations (0-100).	Benefit
C7	R&D Intensity	The ratio of an enterprise's R&D expenditures to its total revenue (%)	Benefit
C8	Cost Increase Rate	The rate of increase in the cost of a product or service over a specified period (%)	Cost
C9	Profitability Ratio	It is the ratio obtained by dividing operating profit by net sales, which expresses what percentage of net sales goes to operating profit (%)	Benefit
C10	Number of Social Responsibility Project	The number of projects carried out by enterprises to benefit the society.	Benefit
C11	Customer Satisfaction	A criterion indicates how much a product meets the customer's expectations. It is evaluated on a 10-point scale.	Benefit
C12	Employee Satisfaction	The criterion expresses the degree of satisfaction of employees with their experience and conditions at the workplace. Evaluated on a 5-point scale	Benefit

**Methods**

*The Collection of the Data*

The hypothetical data set related to the problem is also presented in Table 2.

Table 2. Hypotetic data set

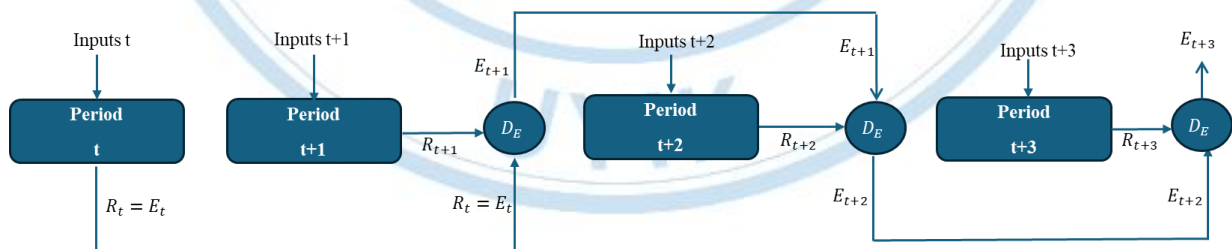
Period	Firm	C1	C2	C3	C4	C5	C6	C7	C8	C9	C10	C11	C12
t	A	100	20000	5	130	80	85	7	3	10	3	8	4
	B	120	22000	4	160	75	80	6	4	8	2	7	4.8
	C	90	18000	6	140	80	88	6.5	2.8	7	2	9	4.2
	D	110	21000	3	145	81	82	6.5	3	9	3	8	4.5
	E	95	19000	4	135	77	79	6	4	8	2	7	3.8
t+1	A	105	19800	4.5	125	82	86	7.5	2.5	12	4	7.5	4.5
	B	122.5	21800	3.8	155	78	82	6.5	3.5	11	3	8	4.3
	C	92	17800	5.8	115	86	89	8.5	1.5	9	5	9.5	5.1
	D	112	20800	2.8	140	84	83	7	2.5	10	4	8.5	4.8
	E	97	18800	3.9	133	79	80	6.5	3.5	10	3	7.5	3.9
t+2	A	110	19600	4	120	85	87	8	2	15	5	7	4.7
	B	125	21600	3.6	150	81	84	7	3	14	4	8.5	4.5
	C	94	17600	5.6	110	89	90	9	1	11	6	9	5
	D	114	20600	2.6	135	85	83	7.5	2	11.5	5	8	4.3
	E	99	18600	3.8	131	82	81	7	3	11	4	7.8	3.5
t+3	A	98	20000	4.2	125	88	87	9	2	13	6	7.7	4.5
	B	110	21650	3.7	140	86	84	8	2	13.5	3	8.6	4.4
	C	90	18000	5.3	120	90	90	9	1	12	5	8	4.9
	D	115	20000	2.9	130	91	83	7.5	2	11	6	8.3	4.3
	E	100	17000	3.5	130	85	81	6	2	10	5	7.6	3.9

*Dynamic MCDM Model*

Campanella and Ribeiro (2011) introduced the general form of the DMCDM model (Equation 1). The authors proposed a generic model for multi-attribute problems with time-dependent and dynamic alternatives and criteria sets.

$$E_t(a) = \begin{cases} R_t(a), & a \in A_t \setminus H_{t-1}^A \\ D_E(E_{t-1}(a), R_t(a)), & a \in A_t \cap H_{t-1}^A \\ E_{t-1}(a) & a \in H_{t-1}^A \setminus A_t \end{cases}$$

In the Equation 1,  $A_t$  denotes the set of alternatives at period  $t$ ;  $H_{t-1}^A$  denotes a historical set of alternatives at period  $t - 1$ .  $R_t(a)$  indicates the static rating score of alternative  $a$  at period  $t$ , and  $E_{t-1}(a)$  means the dynamic rating score of alternative  $a$  at period  $t - 1$ .  $D_E$  is an aggregation function. The critical step in Campanella and Ribeiro's DMCDM model is aggregating the ratings for  $t$  and  $t-1$  periods using an operator (Figure 1).



**Figure 1.** Campanella and Ribeiro's DMCDM model

Aggregation functions (or operators) combine inputs like degrees of membership in fuzzy sets, preference, evidence strength, or hypothesis support (Baliakov et al., 2007: 2). In the DMCDM case, the aggregation operator produces a dynamic carry-over score as a link between the sequential periods. The literature has different types of aggregation functions, some of which are shown in Table 2.

Table 2. Types of aggregation functions

Name of function	Function *
Arithmetic Mean	$\frac{x_1 + x_2}{2}$
Weighted Mean	$w_1x_1 + w_2x_2$
Geometric Mean	$\sqrt{x_1 \cdot x_2}$
Einstein Sum	$\frac{x_1 + x_2}{1 + x_1 \cdot x_2}$
Dual Product	$1 - ((1 - x_1)(1 - x_2))$
3 - $\pi$ Function	$\frac{x_1 \cdot x_2}{(x_1 \cdot x_2) + (1 - x_1)(1 - x_2)}$
Hammacher Intersection	$\frac{x_1 + x_2}{\beta + (1 - \beta)(x_1 + x_2 - x_1 \cdot x_2)}$

Source: (Baliakov et al., 2008; Jassbi et al., 2014)

\* The functions were written specifically for the two-variable aggregation process.

The previous period's performance score can also be incorporated into the decision problem as an additional criterion for ex-post enterprise performance assessment over a given period. For investors, the total performance score of the enterprise over previous periods can be evaluated as an input. Therefore, there is no harm in including this situation analytically in the decision-making process. In the proposed method, the static multi-criteria performance score of period  $t=0$  is included as a new criterion in the criterion weighting and ranking process of period  $t=1$ . Similarly, the dynamic performance score of period  $t=1$  is added to the original decision matrix as a new criterion in period  $t=2$ , and the process is continued (Figure 2).

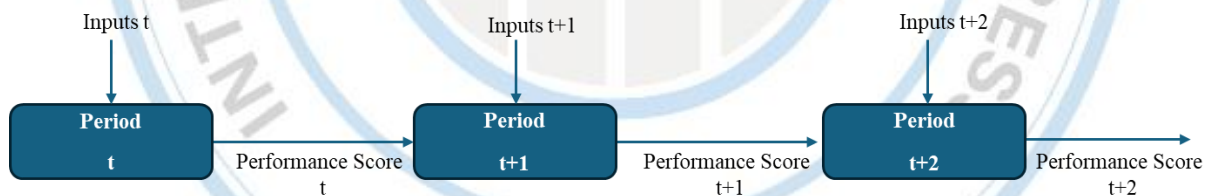


Figure 2. Proposed time-dependent DMCDM model

#### LOPCOW and MCRAT Methods

LOPCOW is an objective criterion weighting method developed by Ecer and Pamucar in 2022. Unlike other objective weighting methods, it can be used for negative values in the decision matrix and prevent serious value differences between the priorities in the relevant criteria. Furthermore, LOPCOW can assist in eliminating dimensional differences (gaps) caused by the data structure by providing appropriate solutions for all benefit and cost-side criteria (Ecer et al. 2023).

The multiple criteria ranking by alternative trace (MCRAT) method extends the problem-solving process by utilizing the categories of ranking and problem selection. The criteria for the optimal solution show the deviation from problem-solving using a decision-making model. The major advantages of MCRAT are its simplicity, logical justification, general applicability, and validity (Abdulaal & Bafail, 2022; Urošević et al., 2021).



**Table 3.** Steps of LOPCOW and MCRAT methods

	Step	Explanation	Formulation
LOPCOW	Step 1	Normalization of decision matrix	$r_{ij} = \frac{x_{ij} - x_j^{min}}{x_j^{max} - x_j^{min}} \text{ for benefit criteria}$ $r_{ij} = \frac{x_j^{max} - x_{ij}}{x_j^{max} - x_j^{min}} \text{ for cost criteria}$
	Step 2	Calculation of the percentage values (PV) of each criterion	$PV_j = \left  \ln \left( \frac{\sqrt{\frac{\sum_{i=1}^m r_{ij}^2}{m}}}{\sigma_{r_{ij}^2}} \right) \cdot 100 \right $
	Step 3	Computing the objective weights	$w_j = \frac{PV_j}{\sum_{j=1}^n PV_j}$
MCRAT	Step 1	Normalization of decision matrix	$r_{ij} = \frac{x_{ij}}{x_j^{max}} \text{ for max criteria}$ $r_{ij} = \frac{x_j^{min}}{x_{ij}} \text{ for min criteria}$
	Step 2	Calculation of the weighted normalized matrix	$u_{ij} = w_j r_{ij}$
	Step 3	Determination of optimal alternative	$d_j = \max_{1 \leq j \leq n} u_{ij}$ Optimal Alternative Set ( $Q$ )
	Step 4	Decomposition of the optimal alternative	$Q = \{q_1, q_2, \dots, q_n\}$ $Q = Q^{max} \cup Q^{min}$
	Step 5	Decomposition of the alternative	$Q = \{q_1, q_2, \dots, q_k\} \cup \{q_1, q_2, \dots, q_h\}, k + h = n$ $U_i = U_i^{max} \cup U_i^{min}$ $U_i = \{u_{i1}, u_{i2}, \dots, u_{ik}\} \cup \{u_{i1}, u_{i2}, \dots, u_{ih}\}, k + h = n$
	Step 6	Magnitude of component	$Q_k = \sqrt{q_1^2 + q_2^2 + \dots + q_k^2}$ $Q_h = \sqrt{q_1^2 + q_2^2 + \dots + q_h^2}$
	Step 7	Calculating the alternatives trace and ranking the alternatives according to the descending order of $tr(T_i)$	$F = \begin{bmatrix} Q_k & 0 \\ 0 & Q_h \end{bmatrix}, \quad G_j = \begin{bmatrix} U_{ik} & 0 \\ 0 & U_{ih} \end{bmatrix}$ $T_i = F \cdot G_j = \begin{bmatrix} t_{11;i} & 0 \\ 0 & t_{22;i} \end{bmatrix}$ $tr(T_i) = t_{11;i} + t_{22;i}$

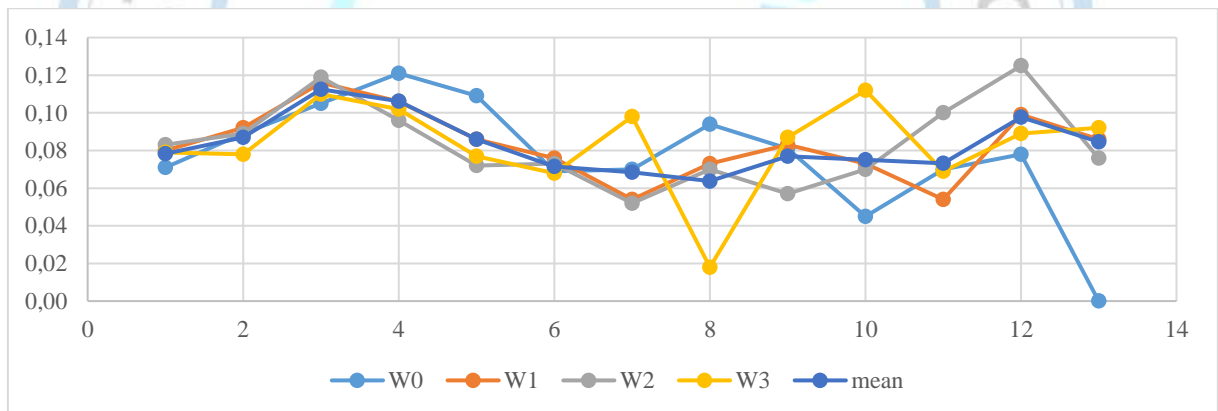
Source: (Ecer & Pamucar, 2022; Abdulaal & Bafail, 2022)

**RESULTS**

Table 5 presents the results of the dynamic criterion weighting method in conjunction with the LOPCOW method. In the initial period ( $t = 0$ ), the three criteria with the highest weight coefficients were C4 ( $w = 0.121$ ), C5 ( $w = 0.109$ ), and C3 ( $w = 0.105$ ), respectively. While C3 was identified as the criterion with the highest weight in the  $t=1$  period ( $w = 0.116$ ), the same criterion was the second most important in the  $t = 2$  period ( $w = 0.119$ ). The results indicate that C12 ( $w = 0.125$ ) in the  $t = 2$  period and C10 ( $w = 0.112$ ) in the  $t = 3$  period were the criteria with the highest weight. Although fluctuations were observed in the criteria weights according to the years, the paired sample t-tests and the Wilcoxon signed-rank test results indicated that the rank values of the criteria did not show statistically significant differences over the years. Upon examination of the mean criterion weights calculated for all periods, it is notable that the criterion rankings are highly consistent with those observed in the  $t = 1$  period (Figure 1).

**Table 5.** LOPCOW weights of criteria in periods

$w_t$	C1	C2	C3	C4	C5	C6	C7	C8	C9	C10	C11	C12	$TR_{t-1}$
<b>W<sub>0</sub></b>	0.071	0.089	0.105	0.121	0.109	0.069	0.070	0.094	0.081	0.045	0.070	0.078	-
<b>W<sub>1</sub></b>	0.080	0.092	0.116	0.106	0.086	0.076	0.054	0.073	0.083	0.073	0.054	0.099	0.086
<b>W<sub>2</sub></b>	0.083	0.089	0.119	0.096	0.072	0.073	0.052	0.070	0.057	0.070	0.100	0.125	0.076
<b>W<sub>3</sub></b>	0.079	0.078	0.110	0.102	0.077	0.068	0.098	0.018	0.087	0.112	0.069	0.089	0.092
<b>Mean</b>	0.078	0.087	0.113	0.106	0.086	0.072	0.069	0.064	0.077	0.075	0.073	0.098	0.085
<b>s</b>	0.005	0.006	0.006	0.011	0.016	0.004	0.021	0.032	0.014	0.028	0.019	0.020	0.043



**Figure 1.** LOPCOW weights of criteria

Once the criterion weights had been calculated on a period-by-period basis, the performance rankings of the alternatives were obtained using the MCRAT method. The results are presented in Table 6. The alternative scores obtained with the static MCRAT method in the initial period ( $t = 0$ ) are expressed by E1, while the ranking results are expressed by RANK1.

In order to analyze the performance of the enterprises in the period  $t = 1$ , the ranking scores of the period  $t = 0$  (E1) were added to the decision matrix as a new criterion. The weight of this new criterion was calculated as 0.086 by the LOPCOW method (Table 5). Subsequently, the dynamic MCRAT scores for the corresponding period were calculated and reported using seven distinct aggregation functions (D1: Dual Product, D2: Arithmetic Mean, D3: Geometric Mean, D4: Weighted Mean, D5: Hammacher Intersection, D6: Einstein Sum, D7:  $3\pi$  Function) and the proposed model as outlined by Campenalla and Ribeiro (2011) (Table 6).

**V. INTERNATIONAL APPLIED STATISTICS CONGRESS (UYIK - 2024)**  
**İstanbul / Türkiye, May 21-23, 2024**

**Table 6.** Dynamic MCRAT scores and ranking results

Period	Method	Alternatives				
		A	B	C	D	E
t=0	E1	0.0805277	0.0738781	0.0780277	0.08244488	0.07528149
	RANK 1	2	5	3	1	4
t=1	E2D1	0.1611642	0.1507203	0.1636899	0.1665563	0.1515344
	Rank D1	3	5	2	1	4
	E2D2	0.0841132	0.0784251	0.0854698	0.0870570	0.0788711
	Rank D2	3	5	2	1	4
	E2D3	0.0840367	0.0782932	0.0851452	0.0869347	0.0787894
	Rank D3	3	5	2	1	4
	E2D4	0.0859059	0.0806986	0.0891908	0.0893630	0.0806659
	Rank D4	3	4	2	1	5
	E2D5	0.2897546	0.2726121	0.2937889	0.2985093	0.2739686
	Rank D5	3	5	2	1	4
	E2D6	0.1670466	0.1558945	0.1697092	0.1728079	0.1567690
	Rank D6	3	5	2	1	4
	E2D7	0.0083487	0.0071659	0.0085942	0.0089865	0.0072633
	Rank D7	3	5	2	1	4
	TR2	0.0805063	0.0759450	0.0846172	0.0840102	0.0756856
	RANK TR2	3	4	1	2	5
	t=2	E3D1	0.2363093	0.2248567	0.2439000	0.2436416
Rank D1		3	4	1	2	5
E3D2		0.0886406	0.0851326	0.0944107	0.0920796	0.0823518
Rank D2		3	4	1	2	5
E3D3		0.0886356	0.0851052	0.0943988	0.0920787	0.0823517
Rank D3		3	4	1	2	5
E3D4		0.0891116	0.0862129	0.0951601	0.0922849	0.0822973
Rank D4		3	4	1	2	5
E3D5		0.2867911	0.2780167	0.3035957	0.2961612	0.2697151
Rank D5		3	4	1	2	5
E3D6		0.1758993	0.1690410	0.1871536	0.1826109	0.1635941
Rank D6		3	4	1	2	5
E3D7		0.0093702	0.0085794	0.0107492	0.0101807	0.0079893
Rank D7		3	4	1	2	5
TR3		0.0819848	0.0797112	0.0876643	0.0847370	0.0754166
RANK TR3		3	4	1	2	5
t=3		E4D1	0.3108812	0.2950270	0.3159985	0.3188382
	Rank D1	3	4	2	1	5
	E4D2	0.0936147	0.0889094	0.0956326	0.0959547	0.0861852
	Rank D2	3	4	2	1	5
	E4D3	0.0935278	0.0888947	0.0956322	0.0958921	0.0860950
	Rank D3	3	4	2	1	5
	E4D4	0.0891116	0.0862129	0.0951601	0.0922849	0.0822973
	Rank D4	3	4	1	2	5
	E4D5	0.2856542	0.2746179	0.2906770	0.2910279	0.2669314
	Rank D5	3	4	2	1	5
	E4D6	0.1856058	0.1764246	0.1895319	0.1901607	0.1711021
	Rank D6	3	4	2	1	5
	E4D7	0.0105357	0.0094301	0.0110583	0.0111258	0.0087985
	Rank D7	3	4	2	1	5
	TR4	0.0884230	0.0823394	0.0871053	0.0901549	0.0815964
	RANK TR4	3	4	2	1	5

D1, D2, D3, D4, D5, D6, and D7 indicate the rankings obtained by Campenalla and Ribeiro's DMCDM model with different aggregation operators (D1: Dual Product, D2: Arithmetic Mean, D3: Geometric Mean, D4: Weighted Mean, D5: Hammacher Intersection, D6: Einstein Sum, D7:  $3\pi$  Function). TR denotes the proposed model rankings.



The results of the period  $t=1$  indicate that Enterprise D was the most successful enterprise in all the Campenalla and Ribeiro model results, while Enterprise C was the first alternative in the proposed model. Enterprise C was ranked second in the Campenalla and Ribeiro model results, while Enterprise D was the second most successful enterprise according to the proposed model's results.

In the  $t=2$  period, the dynamic scores of the  $t=1$  period and the  $t=3$  period were added to the decision matrix as new criteria data and dynamic MCRAT analyses were performed. Upon analysis of the results, it is notable that the dynamic ranking results obtained with two distinct approaches and different integration functions exhibit a high degree of parallelism.

### Comparative Analyses

Comparative analyses have been conducted regarding the effectiveness of the proposed model. This scope includes correlation analysis, variability analysis and computational complexity analysis.

#### Correlation Analysis

Correlation analysis is one of the methods used to compare the performance of methods in the multi-criteria decision-making literature (Bandyopadhyay, 2020; Mathew & Sahu, 2018). The analysis results indicate a high level of correlation in the same direction between the scores obtained with the proposed dynamic model and the results of the dynamic multi-criteria decision-making model widely accepted in the literature. In periods  $t = 1$  and  $t = 2$ , the scores of the proposed model exhibited the highest correlation with the model's results employing the weighted average integration function. While the correlation coefficient between the scores remained high, relatively lower correlation coefficients were observed at  $t = 3$ .

**Table 7.** Correlation analysis results of ranking scores

	D1	D2	D3	D4	D5	D6	D7
TR2	0.969	0.969	0.963	0.997	0.969	0.969	0.963
TR3	0.948	0.990	0.990	0.998	0.993	0.990	0.988
TR4	0.960	0.938	0.935	0.794	0.929	0.938	0.935

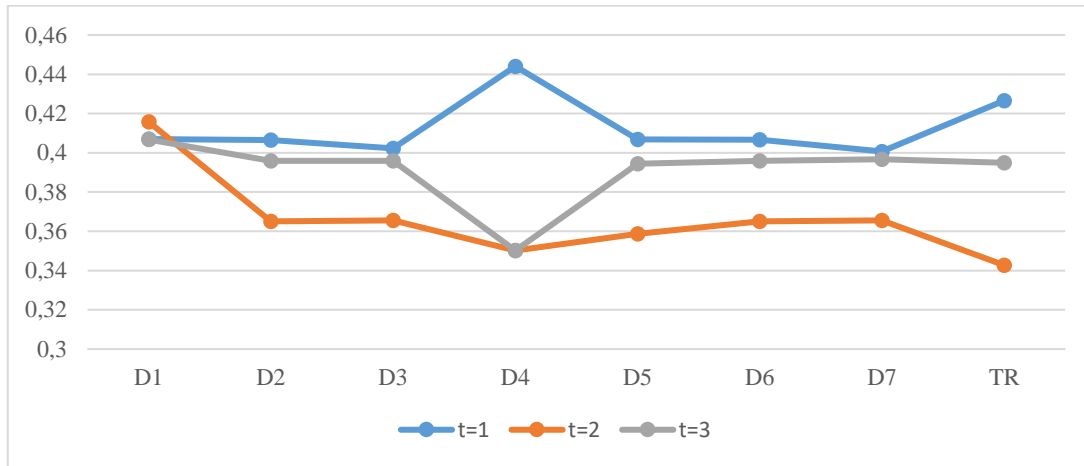
#### Comparison of Variabilities of the Methods

Another method for comparing the outcomes of MCDM techniques is the standard deviation approach, as used by Zaidan et al. (2017) and Baydaş and Pamucar (2022). Baydaş and Pamucar (2022) devised the two-stage standard deviation method, which is influenced by the research of Wang and Rangaiah (2017). In this approach, the final scores from various methods are first normalized using the max-min linear normalization technique as seen in the first equation below. Subsequently, the variations are assessed by computing the standard deviations of the normalized scores by second equation.

$$F_{ij} = \frac{f_{ij} - \min f_{ij}}{\max f_{ij} - \min f_{ij}}$$

$$\sigma_j = \sqrt{\frac{\sum_{i=1}^m (F_{ij} - \bar{F}_{ij})^2}{m}} \quad j = 1, 2, \dots, n \quad ($$

The graph with the calculated standard deviations is given in Figure 2



**Figure 2.** Comparison of the variability of the final scores of the methods

Upon analysis of the graph in Figure 2, it is seen that the standard deviation values of the ranking scores were the highest in the first period and the lowest in the second period. While the proposed model demonstrates the second-best result in separating alternatives in period  $t=1$ , it exhibits the weakest performance in period  $t=2$  and an average performance in period  $t=3$ .

#### *Computing Complexity*

Another criterion used to compare multi-criteria decision-making methods is computational complexity. Computational complexity is the computation time and is evaluated by considering the number of operations used in the methods (Ghaleb et al., 2020).

The complexity score depends upon the number of criteria and alternatives in the decision problem and the number of stages and operations in the algorithms of the methods employed. In the case of the LOPCOW-MCRAT hybrid method, the proposed method's number of operations (where  $m$  denotes the number of alternatives) is approximately  $(4m + 3)$  more.

#### **DISCUSSION AND CONCLUSION**

In this study, a model for dynamic multi-criteria decision making is proposed. The proposed model is applied to a hypothetical business performance problem. The proposed model yielded highly similar ranking results to those produced by the model of Campanella and Ribeiro (2011), which is generally accepted in the literature. While the proposed model is considered to have a weaker processing complexity criterion, it is easier to understand and implement. The degree to which the ranking scores obtained in the proposed model discriminate the alternatives is acceptable. The model was evaluated only for the LOPCOW-MCRAT integrated method. To ascertain the advantages of the proposed model more clearly, it should be applied to real decision problems with more alternatives, using different multi-criteria decision-making methods, and comparative analyses and sensitivity analyses should be performed. Furthermore, the model can be developed for decision problems where the number of alternatives and criteria differ in time periods.

#### **References**

- Bandyopadhyay S, 2021. Comparison among multi-criteria decision analysis techniques: A novel method. *Progress in Artificial Intelligence*, 10(2): 195-216. <https://doi.org/10.1007/s13748-021-00235-5>
- Baydaş M, Pamučar D, 2022. Determining objective characteristics of MCDM methods under uncertainty: An exploration study with financial data. *Mathematics*, 10 (7): 1115. <https://doi.org/10.3390/math10071115>

- Beliakov G, Pradera, A, Calvo T, 2007. Aggregation Functions: A Guide for Practitioners (Vol. 221). Springer- Heidelberg.
- Busemeyer JR, Pleskac TJ, 2009. Theoretical tools for understanding and aiding dynamic decision making. *Journal of Mathematical Psychology*, 53(3): 126-138.
- Campanella, G, Ribeiro RA, 2011. A framework for dynamic multiple-criteria decision making. *Decision Support Systems*, 52(1): 52-60.
- Ecer F, Pamucar D, 2022. A novel LOPCOW-DOBI multi-criteria sustainability performance assessment methodology: An application in developing country banking sector. *Omega*, 112: 102690.
- Ecer F, Küçükönder H, Kaya SK, Görçün ÖF, 2023. Sustainability performance analysis of micro-mobility solutions in urban transportation with a novel IVFNN-Delphi-LOPCOW-CoCoSo framework. *Transportation research part a: policy and practice*, 172: 103667.
- Ghaleb AM, Kaid H, Alsamhan A, Mian SH, Hidri L, 2020. Assessment and comparison of various MCDM approaches in the selection of manufacturing process. *Advances in Materials Science and Engineering*, 2020: 1-16.
- Gonzalez C, 2005. Decision support for real-time, dynamic decision-making tasks. *Organizational Behavior and Human Decision Processes*, 96(2): 142–154.
- Jassbi JJ, Ribeiro RA, Varela LR, 2014. Dynamic MCDM with future knowledge for supplier selection. *Journal of Decision Systems*, 23(3): 232-248.
- Kornbluth JSH, 1992. Dynamic multi-criteria decision making. *Journal of Multi-Criteria Decision Analysis*, 1(2): 81–92.
- Mathew M, Sahu S, 2018. Comparison of new multi-criteria decision making methods for material handling equipment selection. *Management Science Letters*, 8(3): 139-150. <https://doi.org/10.5267/j.msl.2018.1.004>
- Nejatnia M, Makui A, Jabbarzadeh A, 2023. Developing a continuous dynamic multi criteria decision making model for ranking commodity groups in Iran railways. *Scientia Iranica*.
- Pais TC, Ribeiro RA, 2009, Contributions to Dynamic Multicriteria Decision Making Models. In IFSA/EUSFLAT Conference: 719-724.
- Saaty T, 2007. Time dependent decision-making; dynamic priorities in the AHP/ANP: Generalizing from points to functions and from real to complex variables. *Mathematical and Computer Modelling*, 46 (7): 860–891
- Townsend JT, Busemeyer J, 1995. Dynamic representation of decision-making. *Mind as motion: Explorations in the dynamics of cognition*: 101-120.
- Vo HV, Chae B, Olson DL, 2002. Dynamic MCDM: The case of urban infrastructure decision making. *International Journal of Information Technology & Decision Making*, 1(02): 269-292.
- Wang Z, Rangaiah GP, 2017. Application and analysis of methods for selecting an optimal solution from the Pareto-optimal front obtained by multiobjective optimization. *Industrial & Engineering Chemistry Research*, 56(2): 560-574.
- Zaidan BB, Zaidan AA, Abdul Karim H, Ahmad NN, 2017. A new approach based on multi-dimensional evaluation and benchmarking for data hiding techniques. *International Journal of Information Technology & Decision Making*, 23(2) 1017-1058.
- Zulueta Y, Martínez-Moreno J, Martínez L, Espinilla M, 2013. A discriminative dynamic index based on bipolar aggregation operators for supporting dynamic multi-criteria decision making. In *Aggregation Functions in Theory and in Practise: Proceedings of the 7th International Summer School on Aggregation Operators at the Public University of Navarra*, July 16-20, 2013, Page: 237-248. Pamplona, Spain

#### **Acknowledgment**

No acknowledgment.

#### **Conflict of Interest**

The author have declared that there is no conflict of interest.

#### **Author Contributions**

The author confirms sole responsibility for the following: study conception and design, data collection, analysis and interpretation of results, and manuscript preparation.



## Detection of Breast Cancer Using Ensemble Learning Technique

Yasemin Çetin-Kaya<sup>1\*</sup>

<sup>1</sup>Tokat Gaziosmanpaşa University, Faculty of Engineering and Architecture, Department of Computer Engineering, 60150, Tokat, Türkiye

\*Corresponding author e-mail: yasemin.kaya@gop.edu.tr

### Abstract

*Breast cancer is one of the most common cancers in women. When patients are diagnosed early and treated appropriately, their quality of life and life expectancy improve. Machine learning has been successfully applied in the medical field to detect diseases. In this study, ensemble learning technique was used to detect breast cancer. The machine learning classifiers used in the study included Gaussian Naive Bayes, Decision Tree, K-Nearest Neighbor, Support Vector Classifier, and Multi-Layer Perceptron. In the first stage, these classifiers were initially trained using 5-fold cross validation on predefined parameter values. Voting and stacking ensemble techniques were used to create ensemble models containing five machine learning classifiers. The voting ensemble technique achieved 96.84% accuracy, while the stacking ensemble achieved 97.36% accuracy. In the second stage, the parameters of the machine learning classifiers were optimized using the grid search algorithm. Optimized classifiers were then used to evaluate the ensemble models' performance. Firstly, models for voting ensembles and stacking ensembles were developed using five classifiers. The voting ensemble model achieved 98.95% accuracy, while the stacking ensemble model achieved 99.30% accuracy. Secondly, ensemble models were built using the top three classifiers that had shown the greatest performance. Using three classifiers, the stacking ensemble obtained 99.82% accuracy, while the voting ensemble achieved 99.47% accuracy. The findings indicate that optimizing machine learning classifier parameters improved breast cancer detection performance, with the best results obtained with the model built using the stacking ensemble technique and the optimized machine learning classifiers.*

**Keywords:** Breast Cancer Classification, Machine Learning, Ensemble Learning, Optimization

### INTRODUCTION

Breast cancer is one of the most common cancers in women. It is the second leading cause of death among women, trailing only lung cancer (Siegel et al., 2023). When patients are diagnosed early and treated appropriately, their quality of life and life expectancy improve (Zhu et al, 2023). Machine learning (ML) has been successfully applied in the medical field to detect diseases (Kumar et al., 2022). Researchers are using machine learning algorithms to diagnose breast cancer. Table 1 summarizes studies using machine learning methods in breast cancer detection. Studies mostly tested the individual success of machine learning classifiers. However, the effects of using several models together have also been investigated. The effects of feature selection and reduction were also investigated.

In this study, ensemble learning technique was used to detect breast cancer. Adding sophisticated ensemble ML to breast cancer detection models can increase system performance, leading to earlier identification and better treatment outcomes. This work combines ML models with excellent classification accuracy to create an ensemble ML model for breast cancer diagnosis. This approach compensates for flaws in each base classifiers and optimizes outcomes.

**Table 1.** Summary of the related studies

Studies	Method	Accuracy (%)
Nguyen et al. (2019)	SVM, Logistic Regression, Ensemble voting	98.83
Osman et al. (2020)	Ensemble learning using Radial Based Function Neural Network	97
Salama et al. (2012)	Sequential minimal optimization(SMO), SMO+MLP, SMO+ Instance-based learning (IBK)	97.71
Alshayegi et al. (2022)	Artificial neural network (ANN)	99.47
Agarap (2018)	MLP	99.03
Omondiagbe et al. (2019)	ANN	98.82
Saoud et al. (2019)	ANN	95.6
Dalwinder et al. (2019)	ANN	98.37
Rasool et al. (2022)	Linear Regression with Recursive Feature Elimination	98.06
Kadhim et al. (2022)	Extremely Randomized Trees	97.36
Safdar et al. (2022)	SVM	97.7

## MATERIAL AND METHODS

The Wisconsin Diagnostic Breast Cancer (WDBC) dataset was utilized in this research. This dataset contains data from 569 patients (Wolberg et al, 1995). The class labels are binary coded as malignant or benign. The base features are summarized in Table2. The mean, standard error, and worst or largest were values calculated for these ten features, yielding a total of 30 features. 37% of the data is in the malignant class, whereas 63% of the data falls into the benign class.

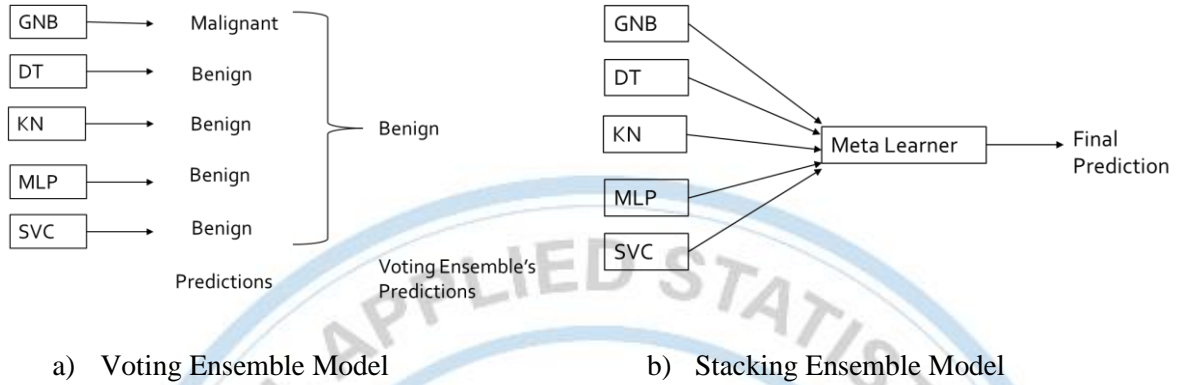
**Table 2.** The base features in the data set

Feature	Type
Area	Continuous
Compactness	Continuous
Concave Points	Continuous
Concavity	Continuous
Fractal Dimension	Continuous
Perimeter	Continuous
Radius	Continuous
Smoothness	Continuous
Symmetry	Continuous

The machine learning classifiers used in the study included Gaussian Naive Bayes (GNB), Decision Tree (DT), K-Nearest Neighbor (KN), Support Vector Classifier (SVC) and Multi-Layer Perceptron (MLP). The study was carried out in two stages. In Stage 1, ML algorithms parameters were used with their default values. In Stage 2, the parameters were optimized. ML algorithms are implemented using the scikit-learn library and Python programming language.

In Stage 1, classifiers were initially trained using 5-fold cross validation on predefined parameter values. Then, voting and stacking ensemble techniques were used to create ensemble models containing five machine learning algorithms. Figure 1.a represent the voting ensemble technique used in the study. The voting ensemble technique combined multiple classifiers, and the class predicted by the majority of these classifiers was used to determine the ensemble model's prediction (Mohammed and Kora, 2023).

In the stacking ensemble technique, the meta learner aggregated the predictions from various classifiers to provide the final prediction (Sagi and Rokach, 2018). In the proposed work, we used ML-based models, namely GNB, DT, KN, MLP and SVC as the base models (see Figure 1.b). For the meta learner, we used Logistic regression to make predictions on the output generated by base layers as features.



**Figure 1.** Ensemble Models.

In Stage 2, the parameters of the machine learning classifiers were optimized using the grid search algorithm. The optimized parameters are listed in Table 3. After the classifiers were trained individually, ensemble models were created. Firstly, models for voting ensembles and stacking ensembles were developed using five ML classifiers. Additionally, ensemble models were created with the three best performing classifiers.

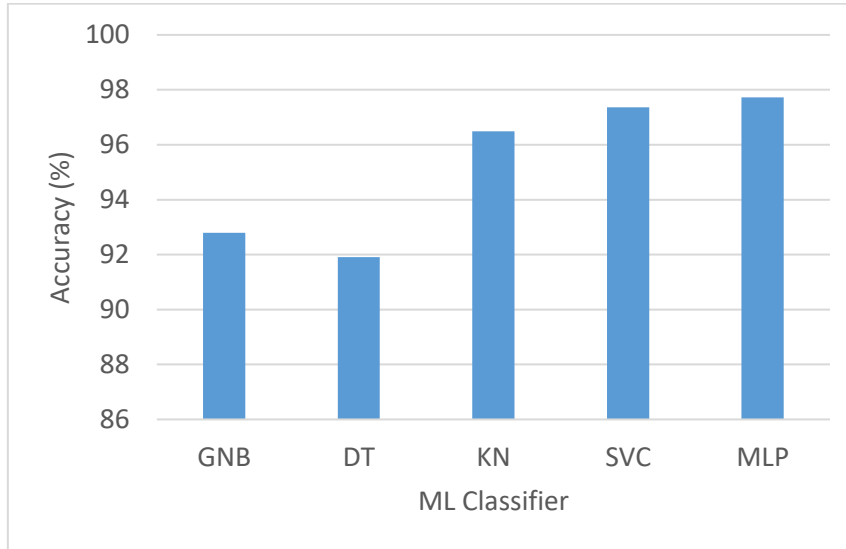
**Table 3.** Optimized parameters

ML Classifier	Parameters
GNB	var_smoothing
DT	criterion, maximum depth, minimum sample leaf, class weight
KN	n_neighbours, weights, algorithm
SVC	C, gamma, kernel, class weight
MLP	solver, learning rate, hidden layer sizes, activation function, learning rate initialization

## RESULTS

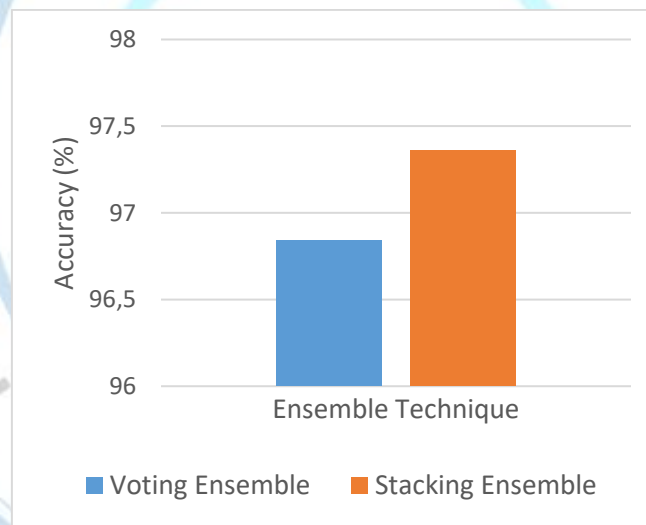
In Stage 1, the performances achieved by ML Classifiers with predefined values are presented in Figure 2. The MLP classifier had the highest success rate, with 97.72% accuracy, followed by SVC (97.36% accuracy) and KN (96.49% accuracy) classifiers.





**Figure 2.** Performance of the ML Classifiers with predifened parameter values

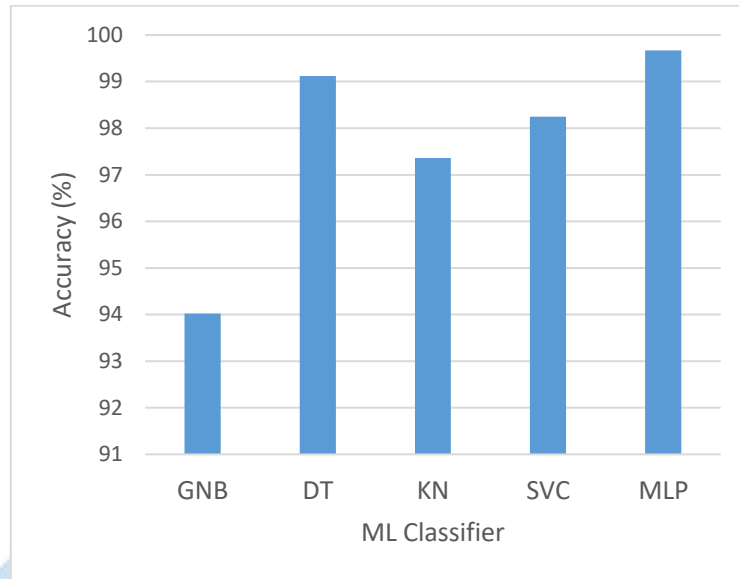
Figure 3 represents the voting and stacking ensemble models' breast cancer detection performance. The voting ensemble technique achieved 96.84% accuracy, while the stacking ensemble achieved 97.36% accuracy. As seen in the graph, the stacking ensemble technique performed better in breast cancer detection.



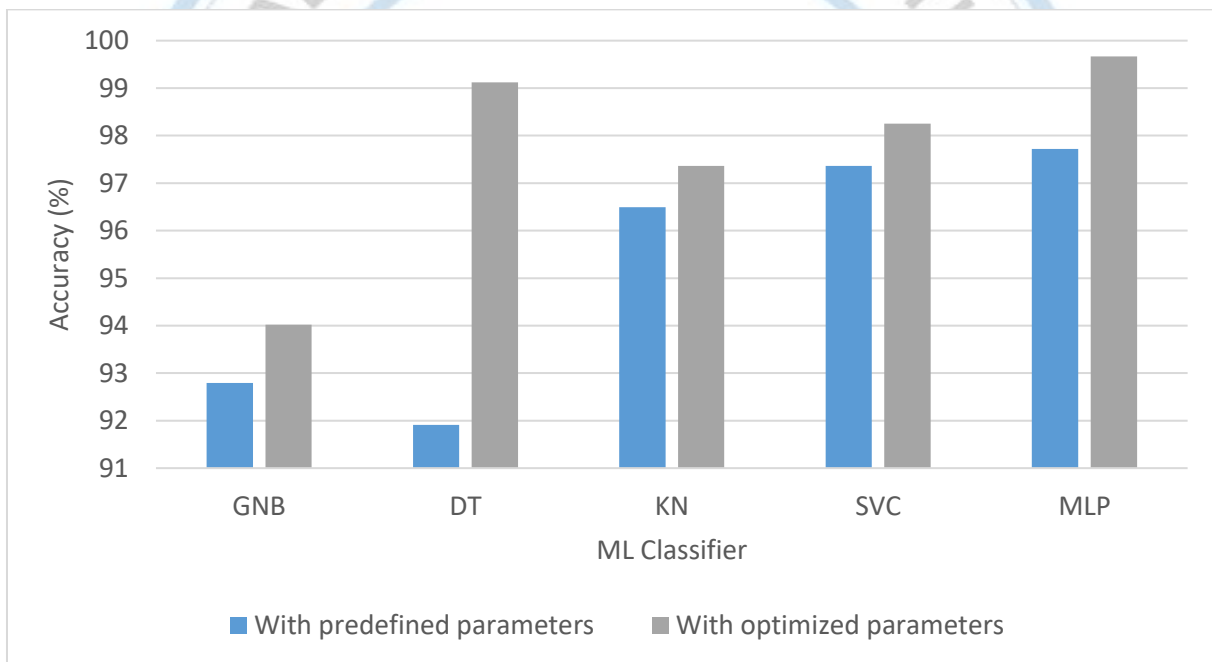
**Figure 3.** Performances of ensemble technique models

In Stage 2, parameters of the ML classifiers were optimized with Grid Search algorithm. The result obtained with the optimized parameters were presented in Figure 4. In breast cancer detection, the MLP classifier achieves the best accuracy (99.67%), followed by DT (99.12%) and SVC (98.25%), respectively.

In order to better observe the effect of parameter optimization, the results obtained at Stage 1 and Stage 2 were collected in a single graph (see Figure 5). It was observed that there was an increase in the performance of all classifiers when parameter optimization was performed. This increase was mostly in the DT classifier.

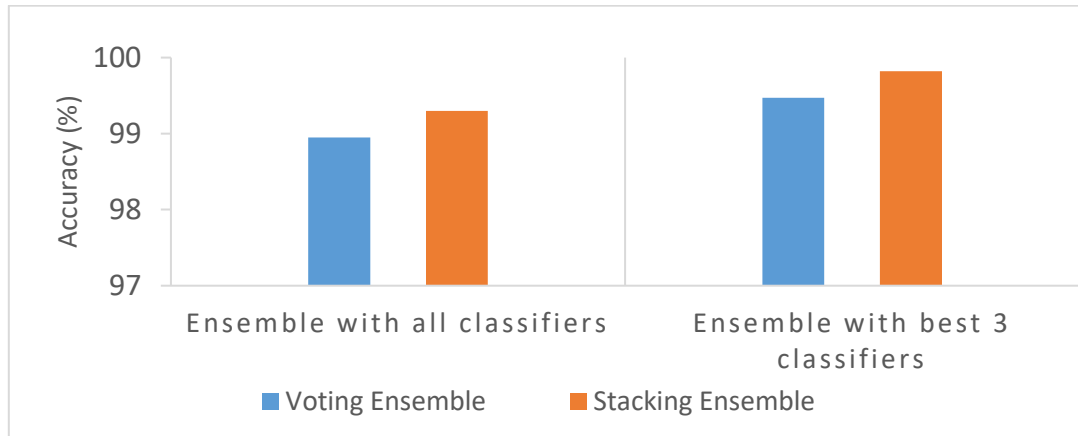


**Figure 4.** Performance of the ML Classifiers with optimized parameter values



**Figure 5.** Effect of parameter optimization on ML classifiers performance

First, voting and stacking ensemble models were developed with the five optimized ML classifiers. The voting ensemble model achieved 98.95% accuracy, while the stacking ensemble model achieved 99.30% accuracy. Secondly, ensemble models were created with the 3 best performing—*MLP*, *DT*, and *SVC*—classifiers. At this stage, the stacking ensemble (99.82%) achieved better performance than voting ensemble (99.47%). In Figure 6, the results are combined in a graph to better observe the effect of model selection on performance. While the stacking ensemble was more successful in both cases, the best performance in breast cancer detection was obtained with the stacking ensemble model created with the best-3 model.



**Figure 6.** Effect of model selection on performance

Table 4 contains the results of the similar studies detecting breast cancer using WDBC dataset. The proposed model is more effective at detecting breast cancer in patients than other studies in terms of accuracy value.

**Table 4.** Comparison with similar studies using the WDBC dataset

Study	Classifier	Accuracy (%)
Kumar et al. (2022)	Optimized stacking ensemble learning	99.45
Nguyen et al. (2019)	SVM, Logistic Regression, Ensemble voting	98.83
Salama et al. (2012)	SMO, SMO+MLP, SMO+IBK	97.72
Alshayegi et al. (2022)	ANN	99.47
Agarap (2018)	MLP	99.03
Omondiagbe et al. (2019)	ANN	98.82
Saoud et al. (2019)	ANN	95.6
Rassol et al. (2022)	Linear Regression with Recursive Feature Elimination	99.3
Proposed Model	Stacking Ensemble with best 3 ML Classifiers	<b>99.82</b>

## CONCLUSION

Breast cancer is one of the main causes of death for women, therefore, early identification is essential. Advanced machine learning classifiers can improve early breast cancer tumor detection. A number of model variables affect a model's ability to predict outcomes better. When multiple independent learning algorithms are combined into an ensemble learning technique, the resultant performance is frequently either better than or on par with a single base classifier.

In this study, five machine learning classifiers were used for breast cancer diagnosis. When the individual performances of ML classifiers were evaluated, it was observed that the MLP classifier was more successful than other classifiers in detecting breast cancer. In the study, the parameters of the classifiers were also optimized. It has been found that when the parameters of ML classifiers are optimized, their performance increases. ML classifiers are combined under two different ensemble learning techniques: voting and stacking. The findings indicate that optimizing ML classifier parameters improved breast cancer detection performance, with the best results obtained with the model built using the stacking ensemble technique and the optimized ML classifiers. In the WDBC data set, the best breast cancer diagnosis was obtained with the stacking ensemble technique with 99.82% accuracy. It is planned to investigate the performances of different ML learning algorithms in future studies. To further prove the generalizability of the suggested approach, investigations on various data sets are also planned.



## References

- Agarap, A. F. M. (2018, February). On breast cancer detection: an application of machine learning algorithms on the Wisconsin diagnostic dataset. In Proceedings of the 2nd international conference on machine learning and soft computing (pp. 5-9).
- Alshayegi, M. H., Ellethy, H., & Gupta, R. (2022). Computer-aided detection of breast cancer on the Wisconsin dataset: An artificial neural networks approach. *Biomedical Signal Processing and Control*, 71, 103141.
- Dalwinder, S., Birmohan, S., & Manpreet, K. (2020). Simultaneous feature weighting and parameter determination of neural networks using ant lion optimization for the classification of breast cancer. *Biocybernetics and Biomedical Engineering*, 40(1), 337-351.
- Kadhim, R. R., & Kamil, M. Y. (2022). Comparison of breast cancer classification models on Wisconsin dataset. *Int J Reconfigurable & Embedded Syst ISSN*, 2089(4864), 4864.
- Kumar, M., Singhal, S., Shekhar, S., Sharma, B., & Srivastava, G. (2022). Optimized stacking ensemble learning model for breast cancer detection and classification using machine learning. *Sustainability*, 14(21), 13998.
- Mohammed, A., & Kora, R. (2023). A comprehensive review on ensemble deep learning: Opportunities and challenges. *Journal of King Saud University-Computer and Information Sciences*, 35(2), 757-774.
- Nguyen, Q. H., Do, T. T., Wang, Y., Heng, S. S., Chen, K., Ang, W. H. M., ... & Chua, M. C. (2019, July). Breast cancer prediction using feature selection and ensemble voting. In 2019 International Conference on System Science and Engineering (ICSSE) (pp. 250-254). IEEE.
- Omondigbe, D. A., Veeramani, S., & Sidhu, A. S. (2019, June). Machine learning classification techniques for breast cancer diagnosis. In IOP conference series: materials science and engineering (Vol. 495, p. 012033). IOP Publishing.
- Osman, A. H., & Aljahdali, H. M. A. (2020). An effective of ensemble boosting learning method for breast cancer virtual screening using neural network model. *IEEE Access*, 8, 39165-39174.
- Rasool, A., Bunternghit, C., Tiejian, L., Islam, M. R., Qu, Q., & Jiang, Q. (2022). Improved machine learning-based predictive models for breast cancer diagnosis. *International journal of environmental research and public health*, 19(6), 3211.
- Safdar, S., Rizwan, M., Gadekallu, T. R., Javed, A. R., Rahmani, M. K. I., Jawad, K., & Bhatia, S. (2022). Bio-imaging-based machine learning algorithm for breast cancer detection. *Diagnostics*, 12(5), 1134.
- Sagi, O., & Rokach, L. (2018). Ensemble learning: A survey. *Wiley interdisciplinary reviews: data mining and knowledge discovery*, 8(4), e1249.
- Salama, G. I., Abdelhalim, M., & Zeid, M. A. E. (2012). Breast cancer diagnosis on three different datasets using multi-classifiers. *Breast Cancer (WDBC)*, 32(569), 2.
- Saoud, H., Ghadi, A., Ghailani, M., & Abdelhakim, B. A. (2019). Using feature selection techniques to improve the accuracy of breast cancer classification. In *Innovations in Smart Cities Applications Edition 2: The Proceedings of the Third International Conference on Smart City Applications* (pp. 307-315). Springer International Publishing.
- Siegel, R. L., Miller, K. D., Wagle, N. S., & Jemal, A. (2023). Cancer statistics, 2023. *Ca Cancer J Clin*, 73(1), 17-48.
- Wolberg, William, Mangasarian, Olvi, Street, Nick, and Street, W. (1995). Breast Cancer Wisconsin (Diagnostic). UCI Machine Learning Repository. <https://doi.org/10.24432/C5DW2B>.
- Zhu, J. W., Charkhchi, P., Adekunte, S., & Akbari, M. R. (2023). What is known about breast cancer in young women?. *Cancers*, 15(6), 1917.

## Salamuralık Asma Yapraklarında Bazı Kalite Parametrelerinin Karşılaştırılması

Neval Topcu Altıncı<sup>1</sup>, Seda SUCU<sup>1\*</sup>

<sup>1</sup>Tokat Gaziosmanpaşa University, Agricultural Faculty, Department of Horticulture, 60250, Tokat, Türkiye

\*Sorumlu yazar e-mail:seda.sucu@gop.edu.tr

### Özet

*Bağcılık; hem dünyada hem de ülkemizde ekonomik ve kültürel anlamda önemli tarımsal kollardan birisidir. Bağcılığın temel ürünü üzüm olmakla beraber salamuralık asma yaprağı üretimi de yan ürün olarak, özellikle ülkemizin bazı bölgelerinde ciddi bir ekonomik getiri sağlamaktadır. Yapılan çalışmada ülkemizde, salamuralık asma yaprağı üretiminde ön plana çıkan 'Sultani Çekirdeksiz' ve 'Narince' üzüm çeşitlerinde bazı kalite parametrelerinin karşılaştırılması amaçlanmıştır. İki çeşide ait yapraklarda bakılan parametreler; klorofil değeri, renk değerleri ve mineral madde içeriğini kapsamaktadır. Elde edilen veriler SAS paket programı kullanılarak varyans analizine tabi tutulduktan sonra ortalamaların karşılaştırılmasında LSD çoklu karşılaştırma testi ( $P < 0.05$ ) kullanılmıştır. Sonuçlar incelendiğinde renk değerleri bakımından farklar istatistiksel olarak önemli görülmüş 'Sultani Çekirdeksiz' çeşidi ön plana çıkmıştır, klorofil değeri spad cinsinden verilmiş olup sonuçlar istatistiksel açıdan fark oluşturmuş 'Narince' çeşidi ön plana çıkmıştır. Besin elementi analizleri incelendiğinde iki çeşit arasında Azot ve Kalsiyum mineral madde içeriği bakımından farklar önemli bulunurken 'Sultani Çekirdeksiz' çeşidi daha yüksek değerlere sahip olmuştur. Diğer besin elementi analizlerindeki değerler istatistiksel açıdan önem arz etmemiştir.*

**Anahtar Kelimeler:** Narince, Sultani Çekirdeksiz, LSD, SAS

### GİRİŞ

Üzüm; gerek üretim ve üretilen alan miktarı, gerekse tüketici istekleri bakımından Dünyada ve Ülkemizde oldukça önemli bir yere sahiptir. Bu tarımsal ürünü belki en farklı kılan özelliği sadece yaş meyve olarak tüketilmesi değil aynı zamanda farklı değerlendirme şekilleriyle beraber bir sürdürülebilirliğin olmasıdır.

Ülkemizde üretilen üzümün önemli bir kısmı sofralık, kurutmalık ve şaraplık olarak değerlendirilmektedir. Bu değerlendirme şekillerinden farklı olarak; üzüm suyu, rakı, hardaliye, sirke, turşu, koruk suyu, koruk turşusu, saruç, papara, pepeçura, pekmez, gün balı, köme, köpüklü orcik, üzüm köftesi, üzüm peltesi, bulama, çek çek, köfter, kesme, tarhana, dilme, pestil, bastık, çullama, muska gibi ürünlere de işlenebilmektedir (Cangi ve Yağcı, 2017).

Türkler, asmadan ekonomik anlamda meyvesi olan üzüm dışında, asmanın yapraklarından da faydalanarak zekâ ve kültürlerinin birleşimi sonucu yıllar boyu mutfaklarına "yaprak sarması" adı verilen yeni bir ürün katarak zenginleştirmişlerdir (Gülcü ve ark., 2011; Bal ve ark., 2019).

Asma yaprağı gövdenin yanıl organlarından biri olup tüm bitki yapraklarında olduğu gibi esas görevi fotosentez ve terlemedir (Downton ve ark., 1987; Roper ve Williams, 1989). Asma yaprağının boyutları, şekli ve rengi; çeşit özelliğine, ekolojik koşullara ve yaprağın sürgün üzerindeki konumuna göre farklılık göstermektedir (Kliwer., 1981). Besin içeriği bakımından düşük kalorili, yüksek lifli olarak bilinen asma yaprağı; kimyasal ve biyokimyasal parametreler bakımından; kalsiyum, fosfor, fenolik bileşik, K1 ve C vitamini mineral maddeler, organik asitler, protein ve amino asitler, fenolik bileşikler ve bazı vitaminleri de ihtiva etmektedir (Ribereau ve Reynold, 1971; Nehir ve ark., 1997)

Salamuralık asma yaprağı üretimi için tercih edilen asma yaprakları; ince yapılı, tüysüz, ince damarlı, dilimsiz ya da mümkün olduğunca az dilimli ve ekşimsi hoş bir tada sahip olmalıdır (Başoğlu ve ark.,

2004; Gülcü ve Torçuk, 2016). Bu özelliklere sahip ve salamuralık asma yaprağı olarak ülkemizde en fazla işlenen çeşitler, 'Sultani Çekirdeksiz' (Ege Bölgesi), 'Narince' (Tokat Yöresi), 'Yapıncak' (Trakya Bölgesi) çeşididir. Ülkemizde iç piyasada tercih edilen ve tüketilen yaprağın çok büyük bir kısmı Tokat ve Manisa bölgelerinde üretilmektedir (Cangi ve ark., 2005; Ovayurt ve Söylemezoğlu, 2023).

Son yıllarda salamuralık asma yaprağı üretimine artan ilgi ve talep 'Narince' ve 'Sultani Çekirdeksiz' çeşidinin yetiştirildiği yerlerde üreticiyi yalnızca yaprak üretimine yönlendirmeye dahi başlamıştır. Tokat yöresinde üzümün ikinci plana atıldığı, yaprak miktarını artırmak için asmaların kısa budandığı, sulama ve azotlu gübreleme yapılarak omcaların vejetatif gelişmeye zorlandığı yaprak üretimini amaçlayan çok sık dikim sistemlerinin uygulandığı durumlarla karşılaşabilmektedir. Aynı şekilde Ege bölgesinde de Sultani Çekirdeksiz zaten kuvvetli gelişen bir çeşit olduğu için, zamanında ve bilinçli yapılan yaprak alma, gelişmenin dengelenmesine katkı sağlayabilmektedir (Çelik., 2013; Ağaoğlu ve ark., 1998; Cangi ve Yağcı., 2017). Yapılan çalışma ile Ülkemiz için oldukça önemli salamuralık asma yaprağı çeşitleri 'Narince' ve 'Sultani Çekirdeksiz', renk özellikleri, klorofil içeriği ve besin elementleri bakımından incelenmiş elde edilen sonuçlar ayrıntılı bir şekilde anlatılmaya çalışılmıştır.

## MATERYAL ve YÖNTEM

### Materyal

2023 yılında Tokat ili Merkez ilçesinde gerçekleştirilen çalışmada materyal olarak salamuralık asma yaprağında yoğun olarak tercih edilen Narince ve Sultani çekirdeksiz üzüm çeşitleri kullanılmıştır. Narince üzüm çeşidi Tokat Gaziosmanpaşa Üniversitesi Tarımsal Araştırma ve Uygulama Müdürlüğüne ait Narince bağından, Sultani çekirdeksiz üzüm çeşidine ait yaprak örnekleri ise Orta Karadeniz Geçit Kuşağı Tarımsal Araştırma Enstitüsünden alınmıştır. Örnekler her iki çeşit için ben düşme (EL-35) döneminde olgun yapraklardan alınmış olup tarihler Narince üzüm çeşidi için 03.08.2023, Sultani üzüm çeşidi için ise 01.08.2023'dir.

### Yöntem

Narince ve Sultani çekirdeksiz üzüm çeşitlerine ait olgun yaprak örnekleri alınarak Tokat Gaziosmanpaşa Üniversitesi Ziraat Fakültesi Bağ Yetiştiriciliği ve Islahı laboratuvarında Spad değeri ve renk ( $L^*$ ,  $a^*$ ,  $b^*$ ) değerlerine bakılmıştır. Alınan örnekler daha sonra  $70^{\circ}\text{C}$ 'de 48 saat etüvde kurutulup mineral maddelerin belirlenmesi için öğütülüp hazır hale getirilmiştir.

**Spad değeri:** Yaprak yeşil renk yoğunluğunu belirlemek amacıyla SPAD metre ile (SPAD 502-Plus, Konica Minolta) her bir omcadan on yaprakta, her yaprağın sağ-sol yan dilim ve uc dilimde olmak üzere toplamda 3 okuma yapılmış ve değerlerin ortalaması alınarak tek bir değer olarak kaydedilmiştir. Ortaya çıkan değerlerin ortalaması SPAD değeri cinsinden ifade edilmiştir

**Renk ( $L^*$ ,  $a^*$ ,  $b^*$ ) Değerleri:** Konica Minolta CM-5 model renk ölçüm cihazı kullanılarak çeşitlere ait yaprakların, renk değerleri belirlenmiştir. ( $L^*$ ) parlaklık (0,siyah ;100,beyaz), ( $a^*$ ) kırmızıdan yeşile (+a, kırmızı; -a, yeşil) ve ( $b^*$ ) sarıdan maviye (+b, sarı; -b, mavi) temsil etmektedir. Her omcadan 10 yaprak alınarak ölçümler gerçekleştirilmiştir.

**Mineral Maddelerin Belirlenmesi:** Bitki örnekler  $70^{\circ}\text{C}$ 'de 48 saat etüvde kurutulup mineral maddelerin belirlenmesi için öğütülüp hazır hale getirilmiştir. Nitrojen analizinin standart Kjeldahl yöntemi ile 1 gr ağırlığındaki kuru ve öğütülmüş numuneler ıslak yakma tüplerine konulmuş ve katalizör olarak 5 gr  $\text{K}_2\text{SO}_4$  kullanılmıştır. Tüplere 15 ml konsantre  $\text{H}_2\text{SO}_4$  ilave edilmiş, tüplerin nemli yakma ünitesine yerleştirilmekte, yakma aşaması tamamlandıktan ve soğutulmazsınız ardından tüplere 75 ml distile su ilave edilmiştir. Çözelti, damıtma ünitesinde 5 dakika konsantre NaOH kullanılarak damıtılmış ve daha sonra % nitrojen içeriğini hesaplamak için 0.2 ml HCl ile titre edilmiştir. Başka elementler için numuneler 0,5 gr numune+1 ml  $\text{H}_2\text{O}$  + 5 ml  $\text{HNO}_3$  asit ilave edilerek mikrodalga yakma cihazının uygulama kitabında uygun olan yakma programına göre yakılarak hazırlanmıştır. Ortaya çıkan solüsyon



25 ml olacak şekilde cihaza yerleştirilmiştir. Analizler ICP-OES cihaza yerleştirilerek yapılmıştır.

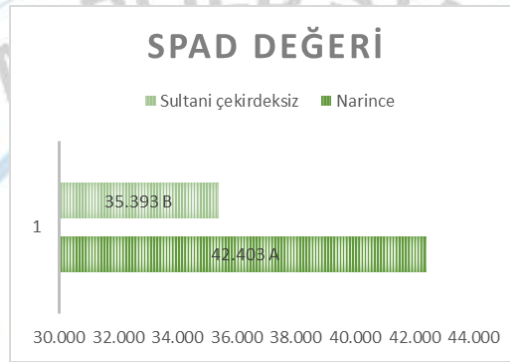
#### İstatistik analiz

Araştırma tesadüf blokları deneme desenine göre 3 tekerrürlü, her tekerrürde 10 omca olacak şekilde düzenlenmiş, çalışmada elde edilen veriler SAS istatistiki paket programı (ver. 9.3, SAS Institute Inc., Cary, NC, USA) kullanılarak tek yönlü varyans analizine (one-way ANOVA) tabii tutulmuş olup, ortalamalar LSD testi' ne göre gruplandırılmıştır (P<0.05).

#### **BULGULAR ve TARTIŞMA**

##### **Spad değerleri;**

'Narince' ve 'Sultani Çekirdeksiz' çeşitlerine ait spad değerleri şekil 1 de verilmiştir. Spad değerleri bakımından çeşitler arasındaki farklar istatistiksel açıdan önemli bulunmuştur. Sultani Çekirdeksiz çeşidinin spad değeri daha yüksek (42.403) çıkmıştır.



Şekil 1. Narince ve Sultani çekirdeksiz üzüm çeşitlerine ait yaprak örneklerinin Spad değerleri

Yapılan çalışmada kullanılan ve son yirmi yıldır oldukça yaygın olan SPAD ölçüm cihazları oldukça popülerdir (Yadava, 1986). Çalışma prensibi; yaprak yüzeyine 650 nm ve 950 nm olmak üzere iki farklı dalga boyunda ışık yayan iki led aydınlatılması ve bu aydınlanma ile meydana gelen ışık fraksiyonlarının ölçülmesine dayanmaktadır. Ölçülen ışık fraksiyonları üretici firma tarafından uygulanan kalibrasyonla eşleştirilerek klorofil konsantrasyonu ile ilişkilendirilmiştir (Gözlemeci, 2013). Yaprığın yeşil renk yoğunluğunun (SPAD) klorofil konsantrasyonu ile yakın ilişkisi bulunmaktadır (Peryea ve Kammereck 1997). Değişik meyve türlerinde yapılan çalışmalarda klorofil miktarının türlere ve çeşitlere göre önemli farklılıklar gösterdiği bildirilmiştir (Gargın ve Göktaş, 2011; Muradoğlu ve Gündoğdu, 2011; Alkan ve ark., 2014). Yapılan çalışmada da bu literatürlere paralel olarak aynı türe ait iki farklı çeşidin spad değerleri farklılık göstermiştir. Yine, Gargın (2011) yapmış olduğu çalışmasında incelemiş olduğu 13 Amerikan asma anacının SPAD değerleri arasında önemli farklılıkların olduğunu ve SPAD değerlerinin 20.62-30.19 değerleri arasında değiştiğini bildirmiştir. Doğan ve ark. (2020), Hizan (Bitlis) Koşullarında Yetiştirilen Üzüm Çeşitlerinin Klorofil Miktarları ve StomaYoğunluklarının Belirlenmesiyle ilgili yaptıkları çalışmada SPADdeğerleri üzerine ise çeşit ve yaprağın alınma konumunun (gölge/güneş) etkisini istatistiki olarak (p<0.001) oldukça önemli bulmuşlardır. Bahsedilen kaynaklardaki bilgiler yapılan çalışma sonuçları ile benzerlik göstermektedir.

##### **Renk değerleri;**

'Narince' ve 'Sultani Çekirdeksiz' çeşitlerine ait renk değerleri L,a,b değerleri cinsinden incelenmiştir. Her üç renk değeri içinde farklar istatistiksel açıdan önemli bulunmuştur. Renk parametreleri bakımından Sultani Çekirdeksiz çeşidi en yüksek değerler ile ön plana çıkmıştır. Narince çeşidine ait renk değerleri; 34.8567 (L değeri), -9.42 (a değeri), 10.61 (b değeri) olarak belirlenirken Sultani Çekirdeksiz çeşidine ait değerler; 37.56 (L değeri), -13.16 (a değeri), 15.63 (b değeri) olarak belirlenmiştir (Çizelge 1)

Tablo 1. Narince ve Sultani çekirdeksiz üzüm çeşitlerine ait yaprak örneklerinin renk (L\*, a\*, b\*) değerleri

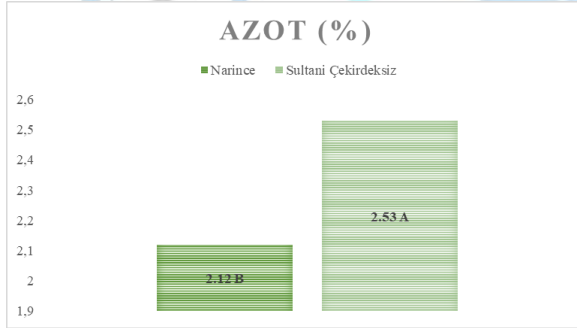
	L*	a*	b*
Narince	34.8567 B	-9.4233 B	10.6100 B
Sultani Çekirdeksiz	37.5667 A	-13.1600 A	15.6333 A

\*Aynı harfle gösterilen ortalamalar arasında fark  $p < 0.05$  seviyesinde önemli değildir.

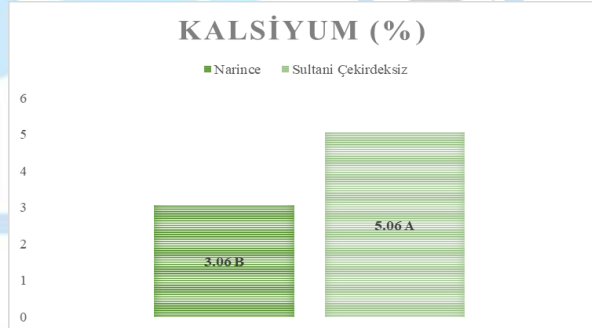
L\* değeri, 0 olduğunda üzüm yaprağına ait rengin siyah, yani yansımanın olmadığını ifade ederken, L\* değeri 100 olduğunda ise rengin beyaz, yani yansımanın tam olduğunu ifade etmektedir. "a\*" değerinde negatif değerler yeşili (-60: Yeşil, +60: Kırmızı) işaret ederken pozitif değerler kırmızı işaret etmektedir. Bütün çeşit ve uygulamalarda değerler yeşil geçiş alanında yer almıştır. "b\*" değeri sarı-mavi renkleri arasındaki konumu ifade etmekte olup, negatif değerler maviyi, pozitif değerler ise sarıyı (-60: Mavi, +60: Sarı) ifade etmektedir. Yapılan çalışmaya ait sonuçlar incelendiğinde Sultani Çekirdeksiz çeşidine ait yaprak örnekleri Narince çeşidine göre daha parlak bulunmuştur. A ve b değerlerine bakıldığında ise her iki çeşit de yeşil geçiş alanında yer almakla beraber en yüksek değerler Sultani Çekirdeksiz çeşidinde elde edilmiştir.

### Besin elementi analizleri:

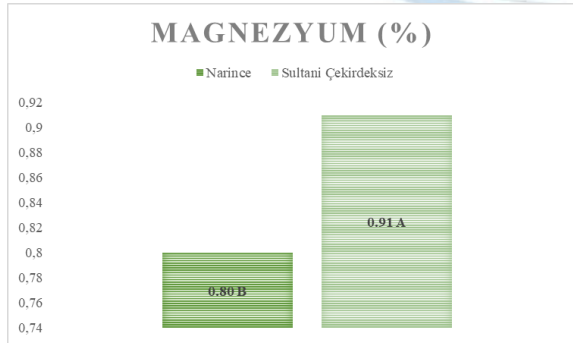
Yapılan çalışmada besin elementi analizlerinde; makro besin elementlerinden azot, kalsiyum ve magnezyum mikro besin elementlerinden demir, çinko, bakır ve mangan incelenmiştir (Şekil 2,3,4,5,6,7.). Narince ve Sultani Çekirdeksiz çeşitlerine ait yaprak örneklerindeki besin elementi analizlerinde makro besin elementine ait örneklerde farklar istatistiksel olarak önem arz etmiştir. Her üç makro besin elementi içinde Sultani Çekirdeksiz çeşidi en yüksek değerler ile ön plana çıkmıştır (Şekil 2,3,4).



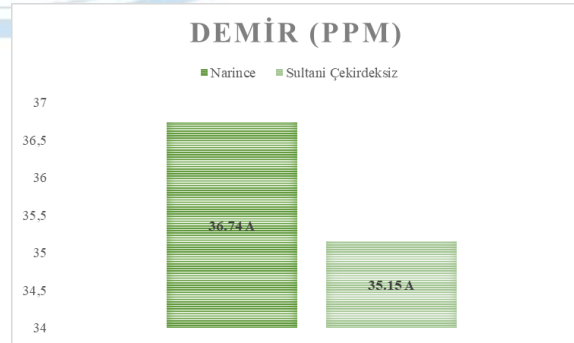
Şekil 2. Narince ve Sultani Çekirdeksiz üzüm çeşitlerine ait yaprak örneklerinin Azot (N, %) içeriği



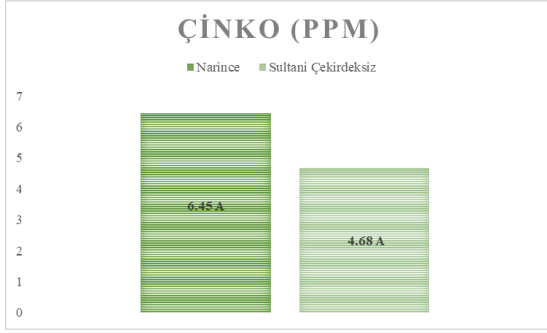
Şekil 3. Narince ve Sultani Çekirdeksiz üzüm çeşitlerine ait yaprak örneklerinin Kalsiyum (Ca, %) içeriği



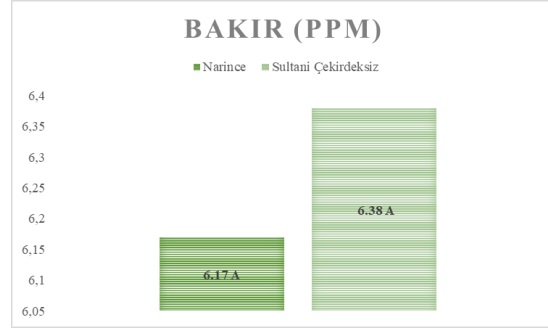
Şekil 4. Narince ve Sultani Çekirdeksiz üzüm çeşitlerine ait yaprak örneklerinin Magnezyum (Mg, %) içeriği



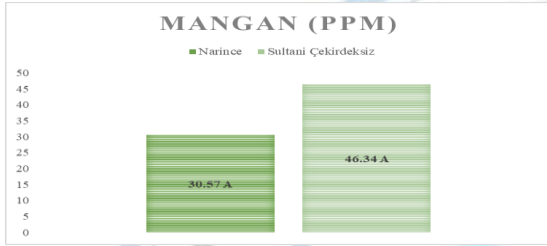
Şekil 5. Narince ve Sultani Çekirdeksiz üzüm çeşitlerine ait yaprak örneklerinin Demir (Fe, ppm) içeriği



Şekil 6. Narince ve Sultani Çekirdeksiz üzüm çeşitlerine ait yaprak örneklerinin Çinko (Zn, ppm) içeriği



Şekil 7. Narince ve Sultani Çekirdeksiz üzüm çeşitlerine ait yaprak örneklerinin Bakır (Cu, ppm) içeriği



Çizelge 8. Narince ve Sultani Çekirdeksiz üzüm çeşitlerine ait yaprak örneklerinin Mangan (Mn, ppm) içeriği

Bitkilerin bitki besin elementi alımı üzerine; bitkinin türü, yaşı, kök büyümesi, toprağın fiziksel, kimyasal ve biyolojik özellikleri, toprakta yayımlı şekilde bulunan elementlerin cins ve miktarları, uygulanan tarımsal yöntemler, kullanılan kimyasallar, hava koşulları gibi çok sayıda faktörün etkili olduğu bilinmektedir (Kacar ve Katkat, 2010; Bolat ve Kara, 2017). Bu bilgilere paralel olarak yapılan çalışmada da iki çeşit arasında makro bitki besin elementleri bakımından farklar istatistiksel açıdan önemli görülürken mikro besin elementleri bakımından herhangi bir fark görülmemiştir.

Maia ve ark., (2021)'nın 7 farklı üzüm çeşidinin yapraklarının besin maddesi içeriklerini araştırdıkları çalışmada ise makro ve mikro besin elementleri çeşitler arasında farklılık göstermektedir. Na, Ca ve K konsantrasyonlarının çalışmada kullanılan tüm çeşitlerde en yüksek değerler ile temsil edilmektedir. Çoban (2023)'ın Sultani Çekirdeksiz üzüm çeşidinde farklı dönemlerde toplanan salamura amaçlı yaprakların bazı fiziksel ve kimyasal özelliklerinin belirlenmesine yönelik yapmış olduğu çalışmada farklı dönemlerde alınan yaprak örneklerinde besin elementleri bakımından farklar istatistiksel açıdan önem arz etmiştir.

## SONUÇ

Asmanın farklı değerlendirilme kollarından olan ve son yıllarda hem ülkemizde hem de dünyada önemini giderek artıran salamuralık yaprak üretiminde en çok kullanılan 'Sultani Çekirdeksiz' ve 'Narince' çeşidine ait yaprak örnekleri bazı kalite parametrelerince incelenmiştir. Bu iki çeşit için tüketici istekleri, yaprak özellikleri ve damak tadına hitap konusunda eşdeğer sayılabilmektedir. Çalışmanın sonuçları incelendiğinde ise bakılan parametrelerin birçoğunda Sultani Çekirdeksiz çeşidi ön plana çıkmıştır. Bakılan parametrelerin sınırlı olması elde edilen sonuçlarla bir çeşidin diğer çeşide göre üstün olduğu anlamına gelmemelidir. Bağcılık açısından önemini giderek artıran salamuralık üretime yönelik yaprak çeşitleri ile yapılan çalışmalara her zaman ihtiyaç duyulmaktadır.

## KAYNAKLAR

Ağaoğlu YS, Yazgan A, Kara Z, 1998. Tokat yöresinde Yaprak Salamuralığına Yönelik Asma Yetiştiriciliği Üzerinde Bir Araştırma" *Türkiye II. Bağcılık Sempozyumu*, Bursa, 1988



- Alkan G, Seferoğlu GH, Tekintaş FE, Ertan E, 2014. Aydın ekolojisindeki bazı erik anaç- çeşit kombinasyonlarında klorofil miktarı ve yoğunluklarının belirlenmesi. Adnan Menderes Üniversitesi, Ziraat Fakültesi Dergisi, 11(1), 1-10. Ankara.
- Bal HG, Kaplan E, Kaplan K, 2019. Bağcılık ve Salamura Yaprak Konusunda Çiftçi Yönelimi ve Değerlendirmeleri (Tokat İli Pazar İlçe örneği). 3. Uluslararası Unidokap Karadeniz Semp. 843-857, 21-23 Haziran, Tokat.
- Bolat İ, Kara Ö, 2017. Bitki besin elementleri: Kaynakları, işlevleri, eksik ve fazlalıkları. Bartın Orman Fakültesi Dergisi, 19(1), 218-228. Bulg. J. Plant Physiol. Special Issue, 1-17.
- Cangi R, Kaya C, Kılıç D, Yıldız M, 2005. Tokat Yöresinde Salamuralık Asma Yaprak Üretimi, Hasad ve İşlemede Karşılaşılan Sorunlar ve Çözüm Önerileri. Türkiye 6. Bağcılık Sempozyumu Bildiriler Kitabı 2. Cilt, s:632-640.
- Cangi R, Yağcı A, 2017. Bağdan Sofraya Yemeklik Asma Yaprak Üretimi. Nevşehir Bilim ve Teknoloji Dergisi Cilt 6(Kapadokya Ulusal Bağcılık Çalıştayı Özel Sayı) 137-148.
- Çelik H, 2013. Türkiye Bağcılığında Üretim Hedefleri” *Vizyon 2023 Bağcılık Çalıştayı*, 26-27 Haziran, Tekirdağ Bağcılık Araş.Enstitüsü, Tekirdağ
- Çoban H, 2023. Sultani Çekirdeksiz Üzüm Çeşidinde Farklı Dönemlerde Toplanan Salamura Amaçlı Yaprakların Bazı Fiziksel ve Kimyasal Özelliklerinin Belirlenmesi. ÇOMÜ Ziraat Fakültesi Dergisi, 11(1), 206-211. <https://doi.org/10.33202/comuagri.1281438>
- Doğan A, Uyak C, Akçay A, Keskin N, 2020. Hizan (Bitlis) Koşullarında Yetiştirilen Üzüm Çeşitlerinin Klorofil Miktarları ve Stoma Yoğunluklarının Belirlenmesi. Yuzuncu Yıl University Journal of Agricultural Sciences, 30(4), 652-665. <https://doi.org/10.29133/yyutbd.698508>
- Downton WJS, Grant WJR, Loveys BR, 1987. Diurnal Changes in the Photosynthesis of Field-Grown Grapevines” *New Phyto*. 105, 71–80.
- El Nehir S, Kavas A, Karakaya S, 1997. Nutrient Composition of Stuffed Vine Leaves: A Mediterranean Diatery” *Journal of Food Quality*, 20, 337- 341
- Gargın S, 2011. Bağcılıkta kullanılan farklı Amerikan asma anaçlarının yaprak klorofil yoğunluklarının (SPAD) belirlenmesi. I. Ali Numan Kırış Tarım Kongresi ve Fuarı. 27-3 Nisan, Eskişehir.
- Gargın S, Göktaş A, 2011. Farklı üzüm meyve türlerinde yaprak klorofil miktarlarının belirlenmesi. GAP VI. Tarım Kongresi, 9-12 Mayıs, Şanlıurfa.
- Gözlemeci EŞ, 2013. Bazı Aşılı Tüplü Asma Anaç- Kalem Kombinasyonlarında mikronize Kalsit (Herbagreen) Uygulamalarının Fidanın Vegetatif Gelişmesine Etkileri, Selçuk Üniversitesi Fen Bilimleri Enstitüsü Bahçe Bitkileri Anabilim Dalı 2013, 63 Sayfa.
- Gülcü M, Torçuk Aİ, 2016. Yemeklik Asma Yaprığı Üretimi ve Pazarlamasında Kalite Parametreleri. Cilt (Sayı): 1 (Özel) Sayfa: 75-79. VII. Bahçe Ürünlerinde Muhafaza ve Pazarlama Sempozyumu, 04-07 Ekim 2016.
- Kacar B, Katkat V, 2010. Bitki Besleme. 5. Baskı, Nobel Yayın Dağıtım Tic. Ltd. Şti, Kızılay.
- Kliewer WM, 1981. Grapevine Physiology. *Leaflet* 21231. Division of Agricultural Sciences University of California, 1981
- Maia M, Cavaco AR, 2021. Laureano G., Cunha J., Eiras-Dias, J., Matos, A. R., Duarte, B., Figueiredo A. (2021). More than just wine: the nutritional benefits of grapevine leaves. *Foods* 10, 2251. <https://doi.org/10.3390/Foods10102251>
- Muradoğlu F, Gündoğdu M, 2011. Stomata size and frequency in some walnut (*Juglans regia*) cultivars. *International Journal of Agriculture and Biology*, 13, 1011-1015.
- Ovayurt C, Söylemezoğlu G, 2023. Türkiye’de Ticari Boyutta Salamuralık Olarak Kullanılan Asma Yapraklarının Fiziksel, Duyusal ve Kalite Özellikleri açısından Değerlendirilmesi. *Bahçe*. 52 (Özel Sayı 1): 2791-6379.
- Peryea FJ, Kammereck R, 1997. Use of Minolta SPAD-502 Chlorophyll Meter to Quantify the Effectiveness of Mid-Summer Trunk Injection of Iron on Chlorotic Pear Trees. *Journal of Plant Nutrition*, 20: 1457-1463.
- Ribereau GJ, Reynold E, 1971. Science et Techniques de la Vigne. Tome 1., Biologie de la Vigne. Sols de Vignobles. Ed. Dunod. Paris
- Roper TR, Williams LE, 1989. Net CO2 Assimilation and Carbohydrate Partitioning of Grapevine Leaves In Response to Trunk Girdling and Gibberellic Acid Application” *Plant Physiology*, 89, 1136– 40.

## Veri Zarflama Analizi Yöntemi ile Türkiye’de Faaliyet Gösteren Hayat Dışı Sigorta Şirketlerinin Performanslarının İncelenmesi

Büşra Yazıcı<sup>1\*</sup>, H. Hasan Örkücü<sup>2</sup>

<sup>1</sup>Gazi Üniversitesi Fen Bilimleri Enstitüsü 06500, Ankara, Türkiye

<sup>2</sup>Gazi Üniversitesi Fen Fakültesi 06500, Ankara, Türkiye

\*Sorumlu yazar e-mail: yazicibusbus@gmail.com

### Özet

Sigorta sektörü, ekonomik sistemin dayandığı önemli kurumların başında gelmektedir. Bu sektör, finansal istikrarı sağlamanın yanı sıra bireylerin ve kurumların risklerini yönetmelerine olanak tanıyan kritik bir rol oynamaktadır. Türkiye’de faaliyet gösteren hayat dışı sigorta şirketleri, bu önemli sektörün bir parçası olarak, ekonomik canlılığa ve toplumsal refaha katkıda bulunmaktadır. Bu kapsamda sigorta şirketlerinin finansal performanslarının ortaya konulması önem arz etmektedir. Gerçekleştirilecek olan bu çalışma ile Türkiye’de hayat dışı sigortalar branşında faaliyet gösteren 32 sigorta şirketinin performansları ölçeğe göre sabit getiri varsayımından hareketle kurulan ve Charnes, Cooper ve Rhodes isimlerinin baş harfleriyle anılan CCR Modelinin Çıktı Odaklı Veri Zarflama Yöntemi ile belirlenecektir. Araştırmanın girdi değişkenleri 2018-2022 yılları arasındaki 5 yıllık finansal raporlarından elde edilecek olan personel sayısı, cari varlıklar, cari olmayan varlıklar, öz sermaye, brüt ödenen tazminatlar, faaliyet giderlerinden oluşurken, çıktı değişkenleri brüt yazılan prim ve teknik kar zarar değişkenlerinden oluşacaktır.

**Anahtar Kelime:** Veri Zarflama Analizi, Hayat Dışı Sigortalar, Sigorta Performans Analizi

### Investigation of the Performance of Non-Life Insurance Companies Operating in Turkey Using the Data Envelopment Analysis Method

#### Abstract

The insurance sector is one of the most important institutions on which the economic system is based. In addition to ensuring financial stability, this sector plays a critical role in enabling individuals and institutions to manage their risks. Non-life insurance companies operating in Turkey contribute to economic vitality and social welfare as part of this important sector. In this context, it is important to reveal the financial performance of insurance companies. In this study, the performances of 32 insurance companies operating in the non-life insurance branch in Turkey will be determined by the Output-Oriented Data Envelopment Method of the CCR Model, which is based on the assumption of constant returns to scale and known by the initials of Charnes, Cooper and Rhodes. The input variables of the research will consist of the number of personnel, current assets, non-current assets, equity, gross claims paid, operating expenses, which will be obtained from the 5-year financial reports between 2018-2022, while the output variables will consist of gross written premium and technical profit and loss variables.

**Keywords:** Data Envelopment Analysis, Non-Life Insurance, Insurance Performance Analysis

### GİRİŞ

İnsanlar, var oldukları günden bu yana risklerle dolu bir dünyada yaşamının getirdiği belirsizliklerle başa çıkmak için çeşitli yöntemler geliştirmişlerdir. Belirli risklerin nasıl ve ne zaman ortaya çıkacağını bilmek mümkün olmadığından, bu risklerin yol açabileceği zararları minimize etmek amacıyla bir araya



gelmişlerdir. Böylece, bireylerin tek başlarına karşılamak zorunda kalacakları zararları aralarında bölüşmeleri, sigorta kavramının temellerini atmıştır. Bu bağlamda, insanların korunma ve güvende olma isteği, sigorta kavramını doğurmuştur.

Sigortacılık faaliyetlerinin ortaya çıkışı ve gelişimi, farklı tarihlere ve sebeplere dayandırılmakla birlikte, tarihin ilk yıllarındaki basit uygulamalarla başlamıştır. İlkel toplumlardan başlayarak insanların can ve mal güvenliklerini teminat altına almak amacıyla birbirlerini koruma güdüsüyle hareket etmeleri, sigortacılığın tarihsel geçmişinin oldukça erken tarihlere dayandığını göstermektedir (Keleş Yıldız & Akpınar, 2023).

Bu çalışmada, Türkiye'de faaliyet gösteren hayat dışı sigorta şirketlerinin performansları, Veri Zarflama Analizi (VZA) yöntemi ile incelenecektir. VZA, çoklu girdi ve çıktılarının bulunduğu durumlarda etkinlik ve verimlilik analizleri yapmak için kullanılan bir yöntemdir. Bu analiz yöntemi, sigorta sektöründe şirketlerin performanslarını karşılaştırmalı olarak değerlendirmede önemli bir araçtır.

### Türk Sigorta Sektörü

Türkiye'de sigortacılık sektörü, son yıllarda dinamik bir gelişim göstererek ekonominin önemli bir parçası haline gelmiştir. Teknolojik yenilikler ve düzenleyici çerçevelerin güncellenmesi, sektörün evrim geçirmesini sağlamış ve dijitalleşme, müşteri deneyimini iyileştirme ile risk yönetimi konularındaki yatırımlar, sigorta hizmetlerinin erişimini ve etkinliğini artırmıştır. Genç ve büyüyen nüfus, sigortacılık sektörüne olan talebi sürekli canlı tutmakta ve sektörün uluslararası rekabet gücünü artırmaktadır. Türk sigortacılık sektöründe yer alan kuruluşlar aşağıdaki gibi sınıflandırılmaktadır;

- **Sigorta Şirketleri:** Genellikle anonim şirket formunda kurulan ve bir yönetim kurulu tarafından yönetilen sigorta şirketleri, prim üretimini artırmak ve müşteri ilişkilerini geliştirmek amacıyla aracı kurumlarla çalışır (Güvel & Güvel, 2002; Orhaner, 2014).
- **Prodüktörler:** Sigorta ettirenlere bilgi vererek, şartları müzakere eden ve sigorta sözleşmesi yapmak isteyenlere danışmanlık hizmeti veren prodüktörler, bağımsız çalışma özgürlüğüne sahiptir (7397 sayılı Kanun; Güvel & Güvel, 2002).
- **Sigorta Eksperleri:** Rizikoların gerçekleşmesi sonucunda oluşan hasar ve kayıpları değerlendiren sigorta eksperleri, tarafsız bir şekilde çalışır ve raporları hukuki delil niteliğinde olabilir (Orhaner, 2014; Güvel & Güvel, 2002).
- **Brokerlar:** Sigorta veya reasürans sözleşmesi yapmak isteyenleri temsil eden ve tarafsız davranan brokerlar, sözleşme sürecinde aktif rol oynar (5684 sayılı Kanun; Orhaner, 2014; Erdal & Erdal, 2015).
- **Acenteler:** Sigorta sözleşmeleri yapmaya veya aracılık etmeye yetkili olan acenteler, sigorta işlemlerinde sigortalıların menfaatini gözetir (6102 sayılı Türk Ticaret Kanunu; Erdal & Erdal, 2015; Satılmış, 2021).
- **Bankalar:** Sigorta ürünlerinin dağıtımını yaparak ve müşterilerine sigorta poliçeleri sunarak sektörde yer alan bankalar, 1980'lerden sonra sigortacılık faaliyetlerine başlamıştır (Kotan, 2021; Kaya, 2021).

**Türk sigorta sektörünün genel yapısını incelediğimizde** Türkiye'nin sigorta sektörü, son yıllarda kişi başına düşen yıllık prim üretiminde önemli bir büyüme kaydetmiştir. 2021 yılında kişi başına 124 dolar olan prim üretiminin 2022 yılı sonunda 150 dolara ulaşması beklenmektedir. Türkiye'nin ekonomik büyümesi ve demografik yapısı, sigorta sektörünün büyüme potansiyelini artırmaktadır. Ancak, sektördeki farkındalığın yeterli olmaması, bu potansiyelin tam anlamıyla hayata geçirilmesini geciktirmektedir.

Türkiye'de sigorta mevzuatı, sigorta şirketlerinin hayat ve hayat dışı sigortacılık faaliyetlerini ayrı şirketler olarak yürütmesini zorunlu kılmaktadır. 2021 yılı itibarıyla Türkiye'de toplam 67 sigorta şirketi



faaliyet göstermektedir. Bu şirketlerin sermaye yapıları incelendiğinde, 27'si tamamen yerli sermaye ile faaliyet göstermektedir. Sektör, hem yerli hem de yabancı yatırımcılar için çekici fırsatlar sunmaktadır.

2022 yılı sonu verilerine göre, sektörde faaliyet gösteren 67 sigorta, emeklilik ve hayat şirketi ile 3 reasürans şirketi toplamda 22.819 kişiyi istihdam etmektedir. Sigorta aracıları konumundaki acenteler, prim üretim faaliyetlerinde önemli bir rol oynamaktadır. Türkiye'de 16.802 sigorta acentesi bulunmaktadır ve bu acenteler, şirket yapısına göre personel istihdam etmektedir.

2022 yılı itibarıyla Türk Sigorta Sektörü, hayat dışı branşlarda 204,1 milyar TL ve hayat sigortaları branşında 30,9 milyar TL olmak üzere toplamda 235 milyar TL prim üretmiştir. Prim üretimi, 2022 yılı verilerine göre %123 oranında artmıştır. Sigorta şirketleri topladığı primler karşılığında 2022 yılı sonu itibarıyla ekonomiye 290 trilyon TL üzerinde teminat sağlamıştır.

2014-2022 yılları arasında Bireysel Emeklilik Sistemi (BES) ile ilgili gelişmeler, sigorta sektöründeki genel büyüme trendleriyle paralel olarak ilerlemiştir. BES, Türkiye'de bireysel emeklilik ve tasarruf alışkanlıklarının artmasına katkıda bulunmuştur. 2022 yılı itibarıyla BES katılımcı sayısı 7.801.305 ve fon büyüklüğü 351.406.489.608 TL olarak gerçekleşmiştir.

### Veri Zarflama Analizi (VZA)

Veri Zarflama Analizi (VZA), çeşitli ölçütleri ve farklı ölçü birimlerini kapsayan girdi ve çıktılarla çalışabilen, karşılaştırmalı verimlilik ve etkinlik ölçümü için güçlü bir yöntemdir. Bu yöntem, doğrusal programlamanın geniş bir yelpazede uygulanabilirliği ile dikkat çekmektedir. VZA'nın temelinde benzer türden karar birimlerinin (KVB'lerin) üretim etkinliklerinin değerlendirilmesi yer alır. KVB'lerin belirli ortak özellikleri olması gerekmekte ve aynı hedefe yönelik, benzer işlevler görmesi önemlidir (Öztürk, 2009:47; Kayalidere ve Kargın, 2004).

VZA'nın gelişimi, Farrell'in etkinlik ve verimliliği kıyaslayarak ölçen temel çalışmasıyla başlamıştır. Charnes, Cooper ve Rhodes'un 1978'de ortaya attığı VZA terimi ve CCR modeli, bu alanda çığır açıcı olmuştur. Zamanla VZA, kâr amacı gütmeyen sektörlerden (okullar, hastaneler) kâr amacı güden sektörlerle (bankalar, ulaşım) kadar geniş bir uygulama alanı bulmuştur.

VZA, kar amacı gütmeyen sektörlerde (eğitim, sağlık, kamu hizmetleri) ve kar amacı güden sektörlerde (finans, ulaşım, enerji) geniş bir uygulama yelpazesi sunar. Kar amacı gütmeyen sektörlerde kârlılık yerine başarı ölçütleri ön planda olduğu için, VZA gibi çok yönlü ve esnek bir yöntem önem kazanmaktadır (Charnes vd., 2011:4-6). VZA'nın uygulama alanları arasında şunlar yer alır (Lewin, Morey ve Cook, 1982; Färe, 1985; Sherman ve Gold, 1985; Banker, Conrad ve Strauss, 1986; Thompson vd., 1986):

- **Eğitim Kurumları:** Okulların ve üniversitelerin etkinlik analizi.
- **Sağlık Hizmetleri:** Hastanelerin ve kliniklerin verimlilik ölçümleri.
- **Kamu Hizmetleri:** Belediye hizmetlerinin ve mahkeme sistemlerinin etkinlik değerlendirmesi.
- **Finansal Kuruluşlar:** Banka şubeleri ve sigorta şirketlerinin performans analizi.
- **Ulaştırma ve Enerji:** Ulaşım şirketleri ve enerji dağıtım firmalarının etkinlik ölçümleri

VZA'nın uygulama alanlarında görülen önemli avantajları bulunmaktadır. Bunlar;

- **Görelî Performans Değerlendirme:** Her KVB'nin verimliliği doğrudan birbirleriyle karşılaştırılır, en iyi performans gösteren birimler belirlenir.
- **Parametrik Yöntemlerden Ayrışma:** Regresyon doğrusuna dayalı parametrik yöntemlerin aksine, her KVB'yi ayrı ayrı değerlendirir ve fonksiyonel form ya da hata teriminin dağılımı hakkında varsayım yapmaz.
- **Etkinlik Sınırı:** KVB'ler, etkinlik sınırının üzerindeki veya altındaki konuma göre değerlendirilir, ortalama yerine en iyi uygulamalara göre analiz yapılır (Charnes vd., 2011:7-8).

- **Objektif ve Tarafsız Sonuçlar:** Politikacıların kararlarına veya anket yanıtlarına dayalı olmayan, objektif ve tarafsız sonuçlar sunar.
- **Çoklu Girdi ve Çıktı Analizi:** Tek bir etkinlik skoru üretirken çoklu girdi ve çıktıları dikkate alabilir.

Yukarıdaki avantajlara rağmen bazı dezavantajlar bulunmaktadır. Bunlar;

- **Ağırlıkların Serbestçe Belirlenmesi:** KVB'ler kendine en uygun ağırlıkları belirleme özgürlüğüne sahiptir, bu da bazen gerçek durumu yansıtmayabilir.
- **Genelleme Sorunları:** Bulguların genelleştirilmesi her zaman mümkün olmayabilir, yalnızca belirli veri seti ve koşullar altında anlamlı olabilir (Chu vd., 2008).
- **Veri İhtiyacı:** Yöntemin uygulanabilmesi için geniş ve doğru veri setine ihtiyaç duyulur, eksik veya hatalı veriler sonuçları etkileyebilir.

VZA, performans değerlendirme sisteminde, KVB'lerin etkinliklerini anlamak ve iyileştirmek için kullanılır. Uygulama amaçları arasında etkinlik analizi, yönetim değerlendirmesi, program ve politika analizi, kaynak yeniden atama, etkin birimlerin belirlenmesi ve karşılaştırmalı analizler bulunmaktadır (Altun, 2006:22; Depren, 2008:22-23). VZA, bu geniş kullanım alanlarıyla yönetim bilimlerinde etkin bir karar destek aracı olarak öne çıkmaktadır.

## UYGULAMA

### KVB'lerin Seçimi

VZA etkinlik değerlerinin ölçülmesinde ilk yapılması gereken doğru ve uygun karar verme birimlerini seçmektir. Karar verme birimlerinin aynı rekabet koşullarında olması gerekmektedir. Analiz sonuçlarının anlamlı çıkması için karar verme birimlerinin sayısının girdi ve çıktı toplamının en az üç katı olması gerekmektedir.

Bu çalışmada kullanılan karar verme birimleri, Türkiye'de hayat dışı branşında faaliyet gösteren 32 sigorta şirketi olup, uygulama dönemi 2018-2022 yılları arasını kapsamaktadır. Beş yıllık bir analiz olması sebebiyle son yıllarda faaliyetini devam ettirmeyen ve yeni açılan şirketler çalışmaya dahil edilmemiştir. Birleşme ile tek bir şirket haline gelen şirketlerin dataları da birleştirilerek çalışmaya dahil edilmiştir.

### Girdi ve Çıktıların Belirlenmesi

VZA girdi ve çıktıların seçimi önemli bir aşamadır. Sektörle ilgili en geniş kapsamlı sonuçların elde edilmesini için özenli girdi-çıkıtı belirlenmelidir.

Bu analizde girdi ve çıktı belirlenirken literatür taraması göz önünde bulundurulmuştur. Sigorta sektörünün temel gelir kaynağı olan brüt yazılan primler ve teknik kar zarar çıktı olarak belirlenmiştir. Personel sayısı, cari varlıklar, cari olmayan varlıklar, öz sermaye, brüt ödenen tazminatlar ve şirketin faaliyet giderleri ise girdi olarak belirlenmiştir.

VZA'da yer alan KVB için girdi çıktı değerlerinin ulaşılabilir olması gerekmektedir. Analizde kullanılan veriler Türkiye Sigorta Birliği tarafından yayınlanan istatistiklerden elde edilmiştir.

### Kullanılacak VZA Modelinin Belirlenmesi

VZA'nın CCR model, BCC model ve Toplumsal model olmak üzere üç farklı türü vardır.

Literatür taramasına bakıldığında ölçeğe göre sabit getiri varsayımı altında çıktı odaklı CCR VZA analizi kullanıldığı görülmektedir. Bu çalışmada da VZA modelinin belirlenmesinde literatür çalışması göz önünde bulundurularak ölçeğe göre sabit getiri varsayımı altında çıktı odaklı CCR VZA modelinin kullanılmasına karar verilmiştir. Çıktı odaklı CCR VZA modeli miktarını arttırmaya yönelik çalışırken

aynı zamanda girdi miktarını azaltmaya yönelik sonuçlar verir.

### Verilerin Toplanması

Veri toplama sürecinin sağlıklı ilerlemesi için şirketlerin finansal raporlamalarına kolayca ulaşılabilir olması gerekmektedir. Bu çalışmada veriler Türkiye Sigorta Birliği tarafından her dönem yayınlanan “Şirketler Gelir Tablosu Özet” ve “Şirketler Bilanço Özet” raporlarından yararlanılarak elde edilmiştir. Yıl içerisinde 4 raporlama dönemi mevcuttur. Bu çalışmada yılın son dönemi yayınlanan raporlar dikkate alınmıştır.

### Analiz Sonuçları

Çıktı odaklı CCR VZA modeline göre, 2018-2022 yılları arasında faaliyet göstermiş olan 32 sigorta şirketi 2018, 2019, 2020, 2021,2022 yıllarının her biri için ayrı ayrı analiz edilmiştir. Tablo 1’de sonuçları bir araya getirilmiştir.

Tablo 1.Çıktı odaklı CCR VZA Modeli Etkinlik Sonuçları (2018-2022)

KVB	2018	2019	2020	2021	2022
A1	1.000	1.000	1.000	1.000	1.000
A2	1.000	1.000	0.889	0.844	0.947
A3	1.000	1.000	1.000	1.000	1.000
A4	1.000	0.962	0.989	1.000	1.000
A5	0.914	0.568	0.572	0.759	0.845
A6	1.000	0.987	0.499	1.000	1.000
A7	0.455	0.456	0.640	0.670	0.874
A8	1.000	0.844	0.856	1.000	1.000
A9	1.000	1.000	1.000	1.000	1.000
A10	1.000	1.000	1.000	1.000	1.000
A11	0.821	0.985	0.926	1.000	1.000
A12	1.000	1.000	1.000	1.000	1.000
A13	0.789	0.620	0.674	0.676	0.611
A14	0.731	0.694	0.353	0.579	0.743
A15	0.833	0.613	0.467	0.523	0.629
A16	0.716	0.754	0.670	0.676	0.922
A17	0.627	1.000	1.000	1.000	1.000
A18	0.659	0.638	0.525	0.545	0.488
A19	1.000	0.854	0.899	0.838	0.645
A20	0.761	0.732	0.739	1.000	1.000
A21	1.000	0.870	1.000	0.759	1.000
A22	1.000	1.000	1.000	1.000	1.000
A23	1.000	0.905	0.725	0.582	0.817
A24	0.919	0.711	0.642	0.629	0.669
A25	0.856	0.848	0.748	0.716	0.572
A26	0.807	0.951	0.652	0.868	1.000
A27	0.932	0.748	0.646	0.660	0.509
A28	1.000	1.000	0.681	1.000	1.000
A29	1.000	1.000	0.835	0.740	0.819
A30	1.000	1.000	1.000	1.000	0.646
A31	1.000	1.000	1.000	1.000	1.000
A32	1.000	1.000	1.000	1.000	1.000

Tablo 1’de görüldüğü gibi 8 sigorta şirketi her yıl etkinliklerini korumuşlardır. Bu sigorta şirketleri A1, A3, A9, A10, A12, A22, A31, A32 sigorta şirketleridir. Yıllar içerisinde etkinlik değerine ulaşamayan 10 şirket bulunmaktadır. Bu şirketler ise A5, A7, A13, A14, A15, A16, A18, A24, A25, A27’dir. Etkinlik değeri 1’e ulaşmış olan sigorta şirketleri Tablo 7’de gösterilmektedir. 2018 yılında 18 şirket, 2019 yılında 13 şirket, 2020 yılında 11 şirket, 2021 yılında 16 şirket ve 2022 yılında 17 şirketin etkinlik değeri 1’e ulaşmıştır.



**V. INTERNATIONAL APPLIED STATISTICS CONGRESS (UYİK - 2024)**  
**İstanbul / Türkiye, May 21-23, 2024**

Tablo 2. *Etkin Bulunan Karar Verme Birimleri (2018-2022)*

2018	2019	2020	2021	2022
A1	A1	A1	A1	A1
A2	A2	A3	A3	A3
A3	A3	A9	A4	A4
A4	A9	A10	A6	A6
A6	A10	A12	A8	A8
A8	A12	A17	A9	A9
A9	A17	A21	A10	A10
A10	A22	A22	A11	A11
A12	A28	A30	A12	A12
A19	A29	A31	A17	A17
A21	A30	A32	A20	A20
A22	A31		A22	A21
A23	A32		A28	A22
A28			A30	A26
A29			A31	A28
A30			A32	A31
A31				A32
A32				

Tablo 2’de çıktı odaklı CCR Modeline göre analiz edilmiş olan KVB’ler etkinlik dereceleri gösterilerek sıralanmıştır.

Tablo 3. *Çıktı Odaklı CCR Modeline Göre Etkinlik Sıralaması ve Dereceleri (2018-2022)*

2018		2019		2020		2021		2022	
KVB	Etkinlik Derecesi	KVB	Etkinlik Derecesi	KVB	Etkinlik Derecesi	KVB	Etkinlik Derecesi	KVB	Etkinlik Derecesi
A1	1.000	A1	1.000	A1	1.000	A1	1.000	A1	1.000
A2	1.000	A2	1.000	A3	1.000	A3	1.000	A3	1.000
A3	1.000	A3	1.000	A9	1.000	A4	1.000	A4	1.000
A4	1.000	A9	1.000	A10	1.000	A6	1.000	A6	1.000
A6	1.000	A10	1.000	A12	1.000	A8	1.000	A8	1.000
A8	1.000	A12	1.000	A17	1.000	A9	1.000	A9	1.000
A9	1.000	A17	1.000	A21	1.000	A10	1.000	A10	1.000
A10	1.000	A22	1.000	A22	1.000	A11	1.000	A11	1.000
A12	1.000	A28	1.000	A30	1.000	A12	1.000	A12	1.000
A19	1.000	A29	1.000	A31	1.000	A17	1.000	A17	1.000
A21	1.000	A30	1.000	A32	1.000	A20	1.000	A20	1.000
A22	1.000	A31	1.000	A4	0.989	A22	1.000	A21	1.000
A23	1.000	A32	1.000	A11	0.926	A28	1.000	A22	1.000
A28	1.000	A6	0.987	A19	0.899	A30	1.000	A26	1.000
A29	1.000	A11	0.985	A2	0.889	A31	1.000	A28	1.000
A30	1.000	A4	0.962	A8	0.856	A32	1.000	A31	1.000
A31	1.000	A26	0.951	A29	0.835	A26	0.868	A32	1.000
A32	1.000	A23	0.905	A25	0.748	A2	0.844	A2	0.947
A27	0.932	A21	0.870	A20	0.739	A19	0.838	A16	0.922
A24	0.919	A19	0.854	A23	0.725	A5	0.759	A7	0.874
A5	0.914	A25	0.848	A28	0.681	A21	0.759	A5	0.845
A25	0.856	A8	0.844	A13	0.674	A29	0.740	A29	0.819
A15	0.833	A16	0.754	A16	0.670	A25	0.716	A23	0.817
A11	0.821	A27	0.748	A26	0.652	A13	0.676	A14	0.743
A26	0.807	A20	0.732	A27	0.646	A16	0.676	A24	0.669
A13	0.789	A24	0.711	A24	0.642	A7	0.670	A30	0.646
A20	0.761	A14	0.694	A7	0.640	A27	0.660	A19	0.645
A14	0.731	A18	0.638	A5	0.572	A24	0.629	A15	0.629
A16	0.716	A13	0.620	A18	0.525	A23	0.582	A13	0.611
A18	0.659	A15	0.613	A6	0.499	A14	0.579	A25	0.572
A17	0.627	A5	0.568	A15	0.467	A18	0.545	A27	0.509
A7	0.455	A7	0.456	A14	0.353	A15	0.523	A18	0.488

**V. INTERNATIONAL APPLIED STATISTICS CONGRESS (UYİK - 2024)**  
**İstanbul / Türkiye, May 21-23, 2024**

Her yıla ait ortalama etkinlik değeri Tablo 4’ te gösterilmektedir.

Tablo 4.Çıktı Odaklı CCR VZA'ya Göre Ortalama Etkinlik Değeri (2018-2022)

	2018	2019	2020	2021	2022
Ortalama Etkinlik Değeri	0.901	0.867	0.801	0.846	0.867

Tablo 4’e göre 2018 yılı ortalama etkinlik değeri 0.901, 2019 yılı ortalama etkinlik değeri 0.867, 2020 yılı ortalama etkinlik değeri 0.801, 2021 yılı ortalama etkinlik değeri 0.846, 2022 yılı ortalama etkinlik değeri 0.867’ dir. Beş yıl içerisinde ortalama etkinlik değerlerinde büyük bir değişiklik meydana gelmemiştir. Tablo 5’de etkinlik düzeyi yüksekten düşüğe sıralanmış olan sigorta şirketleri yer almaktadır.

Tablo 5. Çıktı Odaklı CCR Modeline Göre Etkinlik Sıralaması (2018-2022)

Sıra	2018	2019	2020	2021	2022
1	A1	A1	A1	A1	A1
2	A2	A2	A3	A3	A3
3	A3	A3	A9	A4	A4
4	A4	A9	A10	A6	A6
5	A6	A10	A12	A8	A8
6	A8	A12	A17	A9	A9
7	A9	A17	A21	A10	A10
8	A10	A22	A22	A11	A11
9	A12	A28	A30	A12	A12
10	A19	A29	A31	A17	A17
11	A21	A30	A32	A20	A20
12	A22	A31	A4	A22	A21
13	A23	A32	A11	A28	A22
14	A28	A6	A19	A30	A26
15	A29	A11	A2	A31	A28
16	A30	A4	A8	A32	A31
17	A31	A26	A29	A26	A32
18	A32	A23	A25	A2	A2
19	A27	A21	A20	A19	A16
20	A24	A19	A23	A5	A7
21	A5	A25	A28	A21	A5
22	A25	A8	A13	A29	A29
23	A15	A16	A16	A25	A23
24	A11	A27	A26	A13	A14
25	A26	A20	A27	A16	A24
26	A13	A24	A24	A7	A30
27	A20	A14	A7	A27	A19
28	A14	A18	A5	A24	A15
29	A16	A13	A18	A23	A13
30	A18	A15	A6	A14	A25
31	A17	A5	A15	A18	A27
32	A7	A7	A14	A15	A18

Analize göre 2018 yılında A1, A2, A3, A4, A6, A8, A9, A10, A12, A19, A21, A22, A23, A28, A29, A30, A31, A32 şirketleri etkinken diğer şirketler etkinlik sınırına ulaşamamışlardır. A27, A24 ve A5 şirketleri ise 2018 yılına ait ortalama etkinlik düzeyini aşan şirketlerdir. Analize göre 2019 yılında A1, A2, A3, A9, A10, A12, A17, A22, A28, A29, A30, A31, A32 şirketleri etkinken diğer şirketler etkinlik sınırına ulaşamamışlardır. A6, A11, A4, A26, A23, A21 şirketleri ise 2019 yılına ait ortalama etkinlik düzeyini aşan şirketlerdir. 2019 yılında etkin bulunan şirketler 2018 yılında da etkin bulunan şirketlerden oluşmaktadır. Bir önceki yıla göre A17 şirketinin etkinlik sınırına ulaşmıştır. 2019 yılında bir önceki yıla kıyasla etkin şirket sayısında ve etkinlik miktarında bir azalış yaşanmıştır. Analize göre 2020 yılında A1, A3, A9, A10, A12, A17, A21, A22, A30, A31, A32 şirketleri etkinken diğer şirketler etkinlik sınırına ulaşamamışlardır. A4, A11, A19, A2, A8, A29 şirketleri ise 2020 yılına ait ortalama etkinlik düzeyini aşan şirketlerdir. 2020 yılında etkinlik sınırına ulaşan şirketlerinin tamamı 2019 yılında da

V. INTERNATIONAL APPLIED STATISTICS CONGRESS (UYİK - 2024)  
İstanbul / Türkiye, May 21-23, 2024

etkinlik sınırına ulaşan şirketlerden oluşmaktadır. Fakat 2020 yılında da bir önceki yıla kıyasla etkin şirket sayısında ve etkinlik miktarında bir azalış yaşanmıştır.

Analize göre 2021 yılında A1, A3, A4, A6, A8, A9, A10, A11, A12, A17, A20, A22, A28, A30, A31, A32 şirketleri etkinken diğer şirketler etkinlik sınırına ulaşamamışlardır. A26 şirketi ise 2021 yılına ait ortalama etkinlik düzeyini aşan şirkettir. 2021 yılında etkinlik sınırına ulaşan şirket sayısında ve etkinlik miktarında artış yaşanmıştır.

Analize göre 2022 yılında A1, A3, A4, A6, A8, A9, A10, A11, A12, A17, A20, A21, A22, A26, A28, A31, A32 şirketleri etkinken diğer şirketler etkinlik sınırına ulaşamamışlardır. A2, A16, A7 şirketleri ise 2022 yılına ait ortalama etkinlik düzeyini aşan şirkettir. 2021 yılında etkinlik sınırına ulaşan şirket sayısında ve etkinlik miktarında artış yaşanmıştır.

Sigorta şirketlerindeki yıllar içerisindeki değişimlerini ölçmek ve aralarındaki ilişkiyi görmek amacıyla Malmquist Toplam Faktör Verimliliği testi uygulanmıştır. Analizin bu kısmına kadar Türkiye’de faaliyet gösteren 32 hayat dışı şirketinin 2018-2022 yılsonu dönemi için VZA ile çıktı yönlü CCR etkinliği incelenmiştir. Bu sigorta şirketlerinin zaman içerisindeki değişimlerini, verimlilikteki büyüme miktarlarını Malmquist TFP endeksi kullanılarak ölçülmüştür. Bir önceki yıla göre etkinlik değişimi, teknolojik değişim, saf teknik değişim, ölçek etkinliğindeki değişim ve toplam faktör verimliliğindeki değişim değerleri her sigorta şirketi için ayrı ayrı hesaplanmıştır.

Tablo 6. 2019 yılsonu Malmquist TFV değişim endeksi

KVB	Etkinlik Değişimi	Teknolojik Değişim	Saf Teknik Etkinlik Değişimi	Ölçek Etkinliğindeki Değişim	Toplam Faktör Verimliliğindeki Değişim
A1	1.000	1.219	1.000	1.000	1.219
A2	1.000	1.193	1.000	1.000	1.193
A3	1.000	1.586	1.000	1.000	1.586
A4	0.962	1.420	1.000	0.962	1.366
A5	0.622	0.923	0.621	1.001	0.574
A6	0.987	0.458	1.000	0.987	0.452
A7	1.003	0.884	1.999	0.502	0.887
A8	0.844	1.132	1.000	0.844	0.956
A9	1.000	0.895	1.000	1.000	0.895
A10	1.000	0.739	1.000	1.000	0.739
A11	1.199	0.738	1.202	0.998	0.885
A12	1.000	0.499	1.000	1.000	0.499
A13	0.785	1.167	1.000	0.785	0.916
A14	0.949	0.716	1.000	0.949	0.679
A15	0.735	1.089	1.000	0.735	0.801
A16	1.053	1.084	1.000	1.053	1.141
A17	1.596	0.968	1.000	1.596	1.545
A18	0.968	1.103	1.000	0.968	1.067
A19	0.854	1.015	1.000	0.854	0.867
A20	0.961	0.702	1.000	0.961	0.675
A21	0.870	0.928	1.000	0.870	0.808
A22	1.000	0.656	1.000	1.000	0.656
A23	0.905	1.153	1.000	0.905	1.043
A24	0.773	1.143	0.787	0.983	0.884
A25	0.991	0.647	0.855	1.159	0.641
A26	1.179	0.802	1.000	1.179	0.945
A27	0.803	0.860	0.840	0.956	0.690
A28	1.000	0.514	1.000	1.000	0.514
A29	1.000	0.734	1.000	1.000	0.734
A30	1.000	1.124	1.000	1.000	1.124
A31	1.000	1.207	1.000	1.000	1.207
A32	1.000	1.393	1.000	1.000	1.393
Ortalama	0.958	0.918	0.995	0.963	0.879



**V. INTERNATIONAL APPLIED STATISTICS CONGRESS (UYİK - 2024)**  
**İstanbul / Türkiye, May 21-23, 2024**

2019 yılsonu verilerine göre etkinlik değişimi incelenmiştir. Toplam faktör verimliliği açısından 1.586 değişim ile en iyi performansa sahip sigorta şirketi A3, 0.452 değişim ile en kötü performansa sahip sigorta şirketi A6 sigorta şirkettir.

A3 sigorta şirketinin toplam faktör verimliliği %58,6 oranında gelişim sağlamıştır. Toplam faktör verimliliği performansı incelendiğinde etkinlik değişiminin 1, teknolojik değişiminin 1.586 olduğu görülmektedir. Etkinlik değişim değerinin 1 olması dönemler arasında değişim olmadığını göstermektedir. Toplam faktör verimliliğindeki artışın teknolojik değişimdeki artıştan kaynaklandığı görülmektedir.

A6 sigorta şirketinin toplam faktör verimliliği %54,8 oranında azalmıştır. Toplam faktör verimliliği performansı incelendiğinde etkinlik değişiminin 0.987, teknolojik değişiminin 0.458 olduğu görülmektedir. Etkinlik değişiminin alt unsurlarına bakıldığında saf teknik etkinliğin sabit olduğunu, ölçek etkinliğin ise %1,30 azaldığı görülmektedir. Etkinlik değişimindeki azalışın kaynağı ölçek etkinliğindeki azalıştan kaynaklandığı görülmektedir. Teknolojik değişimdeki %54,2 azalışın ise elde edilen verimlilik kaybında etkinlik değişimine göre daha aktif olduğu görülmektedir.

Tablo 7. 2020 yılsonu Malmquist TFV değişim endeksi

KVB	Etkinlik Değişimi	Teknolojik Değişim	Saf Teknik Etkinlik Değişimi	Ölçek Etkinliğindeki Değişim	Toplam Faktör Verimliliğindeki Değişim
A1	1.000	1.098	1.000	1.000	1.098
A2	0.889	1.256	1.000	0.889	1.116
A3	1.000	1.359	1.000	1.000	1.359
A4	1.028	1.327	1.000	1.028	1.365
A5	1.006	1.166	0.963	1.044	1.173
A6	0.506	0.784	1.000	0.506	0.397
A7	1.402	1.218	1.000	1.402	1.708
A8	1.014	1.397	1.000	1.014	1.417
A9	1.000	0.894	1.000	1.000	0.894
A10	1.000	0.593	1.000	1.000	0.593
A11	0.940	1.096	1.000	0.940	1.030
A12	1.000	0.703	1.000	1.000	0.703
A13	1.087	1.236	1.000	1.087	1.344
A14	0.508	1.238	1.000	0.508	0.629
A15	0.762	1.270	0.547	1.394	0.968
A16	0.888	1.240	1.000	0.888	1.102
A17	1.000	1.063	1.000	1.000	1.063
A18	0.823	1.064	1.000	0.823	0.876
A19	1.053	1.037	1.000	1.053	1.092
A20	1.010	0.785	1.000	1.010	0.793
A21	1.150	0.998	1.000	1.150	1.148
A22	1.000	0.944	1.000	1.000	0.944
A23	0.802	1.105	1.000	0.802	0.886
A24	0.903	1.101	0.847	1.066	0.994
A25	0.882	1.149	1.014	0.870	1.014
A26	0.685	1.381	1.000	0.685	0.946
A27	0.864	1.069	0.817	1.057	0.923
A28	0.681	0.685	1.000	0.681	0.466
A29	0.835	1.275	1.000	0.835	1.064
A30	1.000	1.352	1.000	1.000	1.352
A31	1.000	1.931	1.000	1.000	1.931
A32	1.000	1.453	1.000	1.000	1.453
Ortalama	0.911	1.102	0.969	0.940	1.004

2020 yılsonu verilerine göre etkinlik değişimi incelenmiştir. Toplam faktör verimliliği açısından 1.931 değişim ile en iyi performansa sahip sigorta şirketi A31, 0.397 değişim ile en kötü performansa sahip sigorta şirketi A6 sigorta şirkettir.

**V. INTERNATIONAL APPLIED STATISTICS CONGRESS (UYİK - 2024)**  
**İstanbul / Türkiye, May 21-23, 2024**

A31 sigorta şirketinin toplam faktör verimliliği %93,1 oranında gelişim sağlamıştır. Toplam faktör verimliliği performansı incelendiğinde etkinlik değişiminin 1, teknolojik değişiminin 1.931 olduğu görülmektedir. Etkinlik değişim değerinin 1 olması dönemler arasında değişim olmadığını göstermektedir. Toplam faktör verimliliğindeki artışın teknolojik değişimdeki artıştan kaynaklandığı görülmektedir.

A6 sigorta şirketinin toplam faktör verimliliği %60,3 oranında azalmıştır. Toplam faktör verimliliği performansı incelendiğinde etkinlik değişiminin 0.506, teknolojik değişiminin 0.784 olduğu görülmektedir. Etkinlik değişiminin alt unsurlarına bakıldığında saf teknik etkinliğin sabit olduğunu, ölçek etkinliğin ise %49,4 azaldığı görülmektedir. Etkinlik değişimindeki azalışın kaynağı ölçek etkinliğindeki azalıştan kaynaklandığı görülmektedir. Toplam faktör verimliliğindeki azalışın etkinlik değişimindeki %49,4 azalış ve teknolojik değişimdeki %21,6 azalıştan kaynaklı olduğu görülmektedir. Etkinlik değişimindeki azalışın elde edilen verimlilik kaybında teknolojik değişime göre aktif olduğu görülmektedir.

Tablo 8. 2021 yılsonu Malmquist TFV değişim endeksi

KVB	Etkinlik Değişimi	Teknolojik Değişim	Saf Teknik Etkinlik Değişimi	Ölçek Etkinliğindeki Değişim	Toplam Faktör Verimliliğindeki Değişim
A1	1.000	2.413	1.000	1.000	2.413
A2	0.949	0.991	0.907	1.047	0.941
A3	1.000	1.541	1.000	1.000	1.541
A4	1.011	1.369	1.000	1.011	1.385
A5	1.328	1.099	1.534	0.866	1.460
A6	2.004	4.472	1.000	2.004	8.962
A7	1.047	0.923	1.000	1.047	0.967
A8	1.168	1.195	1.000	1.168	1.396
A9	1.000	1.917	1.000	1.000	1.917
A10	1.000	4.069	1.000	1.000	4.069
A11	1.080	1.221	1.000	1.080	1.319
A12	1.000	3.278	1.000	1.000	3.278
A13	1.004	0.872	1.000	1.004	0.876
A14	1.643	1.554	1.000	1.643	2.552
A15	1.119	0.879	1.277	0.876	0.984
A16	1.009	0.911	1.000	1.009	0.919
A17	1.000	1.050	1.000	1.000	1.050
A18	1.039	1.026	0.774	1.342	1.066
A19	0.932	1.041	1.000	0.932	0.969
A20	1.353	2.852	1.000	1.353	3.858
A21	0.759	1.177	1.000	0.759	0.893
A22	1.000	1.974	1.000	1.000	1.974
A23	0.803	1.109	1.000	0.803	0.890
A24	0.980	0.992	1.203	0.815	0.973
A25	0.956	1.350	0.882	1.084	1.290
A26	1.331	1.272	1.000	1.331	1.693
A27	1.021	0.863	1.523	0.670	0.881
A28	1.469	1.630	1.000	1.469	2.395
A29	0.886	0.928	1.000	0.886	0.822
A30	1.000	0.680	1.000	1.000	0.680
A31	1.000	0.638	1.000	1.000	0.638
A32	1.000	1.139	1.000	1.000	1.139
Ortalama	1.068	1.326	1.025	1.042	1.417

**V. INTERNATIONAL APPLIED STATISTICS CONGRESS (UYİK - 2024)**  
**İstanbul / Türkiye, May 21-23, 2024**

2021 yılsonu verilerine göre etkinlik değişimi incelenmiştir. Toplam faktör verimliliği açısından 8.962 değişim ile en iyi performansa sahip sigorta şirketi A6, 0.638 değişim ile en kötü performansa sahip sigorta şirketi A31 sigorta şirkettir.

A6 sigorta şirketinin toplam faktör verimliliği %796,2 oranında gelişim sağlamıştır. Toplam faktör verimliliği performansı incelendiğinde etkinlik değişiminin 2.004, teknolojik değişiminin 4.472 olduğu görülmektedir. Etkinlik değişim değerinin alt unsurlarına bakıldığında saf teknik etkinliğinin sabit, ölçek etkinliğindeki değişimin 2.004 olduğu görülmektedir. Etkinlik değişimindeki artışın ölçek etkinliğindeki artıştan kaynaklandığı görülmektedir. Toplam faktör verimliliğindeki artışın teknolojik değişimdeki %347,2 artıştan ve etkinlik değişimindeki %100,4 artıştan kaynaklandığı görülmektedir.

A31 sigorta şirketinin toplam faktör verimliliği %36,2 oranında azalmıştır. Toplam faktör verimliliği performansı incelendiğinde etkinlik değişiminin 1, teknolojik değişiminin 0.638 olduğu görülmektedir. Toplam faktör verimliliğindeki azalışın teknolojik değişimdeki %36,2 azalıştan kaynaklandığı görülmektedir.

Tablo 9. 2022 yılsonu Malmquist TFV değişim endeksi

KVB	Etkinlik Değişimi	Teknolojik Değişim	Saf Teknik Etkinlik Değişimi	Ölçek Etkinliğindeki Değişim	Toplam Faktör Verimliliğindeki Değişim
A1	1.000	2.071	1.000	1.000	2.071
A2	1.122	1.893	1.103	1.017	2.124
A3	1.000	2.762	1.000	1.000	2.762
A4	1.000	2.604	1.000	1.000	2.604
A5	1.113	2.446	0.936	1.189	2.722
A6	1.000	2.587	1.000	1.000	2.587
A7	1.304	2.157	1.000	1.304	2.812
A8	1.000	1.995	1.000	1.000	1.995
A9	1.000	2.765	1.000	1.000	2.765
A10	1.000	1.894	1.000	1.000	1.894
A11	1.000	3.944	1.000	1.000	3.944
A12	1.000	1.584	1.000	1.000	1.584
A13	0.903	1.634	0.623	1.450	1.476
A14	1.282	1.966	1.000	1.282	2.521
A15	1.204	1.791	0.915	1.316	2.157
A16	1.364	1.847	0.924	1.477	2.520
A17	1.000	1.840	1.000	1.000	1.840
A18	0.895	1.909	0.633	1.414	1.708
A19	0.771	2.150	0.646	1.193	1.656
A20	1.000	2.814	1.000	1.000	2.814
A21	1.318	1.896	1.000	1.318	2.499
A22	1.000	2.368	1.000	1.000	2.368
A23	1.402	1.750	0.817	1.717	2.455
A24	1.063	2.170	0.861	1.236	2.307
A25	0.799	2.214	0.792	1.009	1.769
A26	1.152	1.655	1.000	1.152	1.907
A27	0.772	2.657	0.533	1.448	2.051
A28	1.000	2.448	1.000	1.000	2.448
A29	1.107	1.899	1.000	1.107	2.102
A30	0.646	4.188	1.000	0.646	2.705
A31	1.000	5.721	1.000	1.000	5.721
A32	1.000	2.271	1.000	1.000	2.271
Ortalama	1.024	2.267	0.919	1.115	2.322



**V. INTERNATIONAL APPLIED STATISTICS CONGRESS (UYİK - 2024)**  
**İstanbul / Türkiye, May 21-23, 2024**

2022 yılsonu verilerine göre etkinlik değişimi incelenmiştir. Toplam faktör verimliliği açısından 5.721 değişim ile en iyi performansa sahip sigorta şirketi A31, 1.476 değişim ile en kötü performansa sahip sigorta şirketi A13 sigorta şirkettir.

A31 sigorta şirketinin toplam faktör verimliliği %472,1 oranında gelişim sağlamıştır. Toplam faktör verimliliği performansı incelendiğinde etkinlik değişiminin 1, teknolojik değişiminin 5.721 olduğu görülmektedir. Etkinlik değişim değerinin 1 olması dönemler arasında değişim olmadığını göstermektedir. Toplam faktör verimliliğindeki artışın teknolojik değişimdeki artıştan kaynaklandığı görülmektedir.

A13 sigorta şirketinin toplam faktör verimliliği %47,6 oranında artmıştır. Toplam faktör verimliliği performansı incelendiğinde etkinlik değişiminin 0.903, teknolojik değişiminin 1.634 olduğu görülmektedir. Etkinlik değişim değerinin alt unsurlarına bakıldığında saf teknik etkinliğinin 0.623, ölçek etkinliğindeki değişimin 1.450 olduğu görülmektedir. Etkinlik değişimindeki azalışın saf teknik etkinliğindeki artıştan kaynaklandığı görülmektedir. Etkinlik değişiminde %9,7 azalış varken teknolojik değişimdeki %63,4 artış meydana gelmiştir. Toplam faktör verimliliğindeki artışın teknolojik değişimdeki %63,4 artıştan kaynaklandığı görülmektedir.

Tablo 10. Yıllara göre Malmquist TFV değişim endeksi

Yıllar	Etkinlik Değişimi	Teknolojik Değişim	Saf Teknik Etkinlik Değişimi	Ölçek Etkinliğindeki Değişim	Toplam Faktör Verimliliğindeki Değişim
2	0.958	0.918	0.995	0.963	0.879
3	0.911	1.102	0.969	0.940	1.004
4	1.068	1.326	1.025	1.042	1.417
5	1.024	2.267	0.919	1.115	2.322
Ortalama	0.988	1.321	0.976	1.012	1.305

Analiz sonuçlarına göre; Analize dahil olan tüm sigorta şirketleri için etkinlik değişiminde gelişimin en fazla yaşandığı dönem 2021-2022, gerilemenin en fazla olduğu dönem ise 2018-2019 olarak görülmektedir. Bu analize paralel olarak 2019-2020, 2020-2021, 2021-2022 dönemleri teknolojik ilerlemenin görüldüğü dönemler olurken 2018-2019 döneminde teknolojik gerileme söz konusudur. Toplam faktör verimliliğindeki değişim incelendiğinde büyümenin en fazla yaşandığı dönem 2021-2022 dönemi olup büyüme oranı %132,2'dir. En büyük gerilemenin yaşandığı dönem 2018-2019 dönemi olup gerileme oranı %12,1'dir.

Tüm dönemler boyunca etkinlik değişim değerlerinin (-%8,9) ile (+%6,8) arasında olduğu görülmektedir.

Sonuç olarak büyüme oranları yıllar içerisinde bir artış eğilimi göstermektedir. 2020 ve 2021 yıllarında tüm dünyada yıkıcı etkiye sebep olan Covid 19'un Türk sigorta sektöründe olumsuz bir etkiye neden olmadığı ve 2020-2021 dönemi ve onu takip eden dönemlerde verimlilikte bir artış yaşandığı görülmektedir.

**V. INTERNATIONAL APPLIED STATISTICS CONGRESS (UYIK - 2024)**  
**İstanbul / Türkiye, May 21-23, 2024**

Tablo 11. Sigorta Şirketlerine göre Malmquist TFV değişim endeksi

KVB	Etkinlik Değişimi	Teknolojik Değişim	Saf Teknik Etkinlik Değişimi	Ölçek Etkinliğindeki Değişim	Toplam Faktör Verimliliğindeki Değişim
A1	1.000	1.608	1.000	1.000	1.608
A2	0.986	1.295	1.000	0.986	1.277
A3	1.000	1.741	1.000	1.000	1.741
A4	1.000	1.610	1.000	1.000	1.610
A5	0.981	1.304	0.963	1.019	1.279
A6	1.000	1.428	1.000	1.000	1.428
A7	1.177	1.210	1.189	0.990	1.424
A8	1.000	1.394	1.000	1.000	1.394
A9	1.000	1.435	1.000	1.000	1.435
A10	1.000	1.356	1.000	1.000	1.356
A11	1.050	1.405	1.047	1.003	1.476
A12	1.000	1.162	1.000	1.000	1.162
A13	0.938	1.197	0.888	1.056	0.112
A14	1.004	1.283	1.000	1.004	1.288
A15	0.932	1.215	0.894	1.043	1.132
A16	1.065	1.226	0.980	1.087	1.306
A17	1.124	1.187	1.000	1.124	1.335
A18	0.928	1.231	0.837	1.109	1.142
A19	0.896	1.239	0.897	1.000	1.110
A20	1.071	1.450	1.000	1.071	1.553
A21	1.000	1.199	1.000	1.000	1.199
A22	1.000	1.304	1.000	1.000	1.304
A23	0.951	1.254	0.951	1.000	1.192
A24	0.924	1.283	0.912	1.013	1.185
A25	0.904	1.221	0.882	1.025	1.104
A26	1.055	1.235	1.000	1.055	1.304
A27	0.860	1.205	0.864	0.995	1.036
A28	1.000	1.089	1.000	1.000	1.089
A29	0.951	1.133	1.000	0.951	1.078
A30	0.896	1.442	1.000	0.896	1.293
A31	1.000	1.708	1.000	1.000	1.708
A32	1.000	1.513	1.000	1.000	1.513
Ortalama	0.988	1.321	0.976	1.012	1.305

Analiz sonuçlarına göre; Etkinlik değişim endeksi incelendiğinde sigorta şirketlerinin %21,8'inin yıllık ortalama etkinlik değerlerinde ilerleme olduğu, %40,6'sının değişme kaydetmediği, %37,5'sinin ise etkinlik değerlerinde gerileme olduğu anlaşılmaktadır. Etkinlik değişiminde gelişim gösteren sigorta şirketlerinde ilk üç sırada A7(%17,7) sigorta şirketi, A17(%12,4) sigorta şirketi ve A20(%7,1) sigorta şirketi yer almaktadır. Gerileme gösteren sigorta şirketlerinde ilk üç sırada A19(%10,4) sigorta şirketi, A30(%10,4) sigorta şirketi ve A27(%14,0) sigorta şirketi yer almaktadır.

Teknolojik değişim endeksi incelendiğinde sigorta şirketlerinin %100'ünde dönem boyunca teknolojik ilerleme olduğu gözlenmektedir. Teknolojik değişiminde gelişim gösteren sigorta şirketlerinde ilk üç sırada A3(%74,1) sigorta şirketi, A31(%70,8) sigorta şirketi ve A4(%61,0) sigorta

şirketi yer almaktadır. Tüm sigorta şirketlerinde teknolojiadaki değişimin olumlu yönde bir değişim göstermesi, sigorta şirketlerinin aynı miktar girdi kullanarak üretebilecekleri çıktı miktarında artma olduğu bir başka deyişle üretim seviyelerini artı yönde hareket ettirdikleri anlamına gelir.

Toplam faktör verimliliğindeki değişim endeksi incelendiğinde sigorta şirketlerinin %100'ünde dönem boyunca ilerleme olduğu gözlenmektedir. Toplam faktör verimliliğindeki değişiminde gelişim gösteren sigorta şirketlerinde ilk üç sırada A3(%74,1) sigorta şirketi, A31(%70,8) sigorta şirketi ve A4(%61,0) sigorta şirketi yer almaktadır.

## SONUÇ VE DEĞERLENDİRME

Bu çalışmada Türkiye'de faaliyet gösteren hayat dışı sigorta şirketlerinin primlerinin ve teknik karının maksimum olması istenmektedir. Bu kapsamda personel sayısı, cari varlıklar, cari olmayan varlıklar, öz sermaye, brüt ödenen tazminatlar ve faaliyet giderleri girdi olarak kullanılmıştır. Brüt yazılan primler ve teknik kar zarar çıktı olarak kullanılmıştır.

Girdi değişkenleri sabit tutularak çıktı değişkenlerinin maksimum değere sahip olması amaçlandığından çıktı yönlü CCR modeli ile VZA kullanılarak sigorta şirketlerinin yıllar içerisindeki etkinlik değerleri bulunmuştur. Malmquist TFV analizi ile sigorta şirketlerinin yıllar arasındaki etkinliklerindeki değişimleri bulunmuş ve değişimlerin hangi etkinlikten kaynaklandığı belirtilmiştir.

2020 yılının ilk aylarından itibaren tüm dünyada etkili olmaya başlayan Covid 19, 2020 ve 2021 yılında küresel ekonomiyi derinden etkilemiştir. Türkiye 2020 yılında ekonomik kayıplar yaşayarak salgından olumsuz etkilenmiştir. Bu duruma Türk sigorta sektörü özelinde bakıldığında 2020 yılında güçlü bir büyüme gerçekleştiği, finansal ve teknik alandaki sonuçların iyileştiği görülmektedir. Tablo 2 de yer alan prim üretiminin yıllar içerisindeki seyrine bakıldığında 2020 yılında prim üretiminin arttığı görülmektedir.

Araştırmanın sonucuna göre, 2018-2022 yılları arasında etkin olan sigorta şirketleri Tablo 6'da belirtilmiş olup 8 sigorta şirketi her yıl etkinliklerini korurken 10 sigorta şirketi analiz süresi boyunca etkinlik değerine ulaşamamıştır. Yıllar içerisinde en fazla etkin şube sayısına 2018, en az etkin şube sayısına 2022 yılında ulaşılmıştır. 2022 yılsonu verilerine göre 17 sigorta şirketi etkin çıkmıştır. Malmquist TFV analizine göre yıllar arasındaki şubelerin etkinliklerinin değişimi incelendiğinde toplam faktör verimliliğindeki değişimin en fazla yaşandığı dönem %132,2 büyüme oranıyla 2021-2022 dönemi iken en büyük gerilemenin yaşandığı dönem ise %12,1 gerileme oranıyla 2018-2019 dönemidir. Sonuç olarak büyüme oranlarının yıllar içerisinde bir artış eğilimi göstermektedir. Tablo 15'te yıllar içerisindeki Malmquist TFV değişim endeksi yer almaktadır. 2020 ve 2021 yıllarında tüm dünyada yıkıcı etkiye sebep olan Covid 19'un Türk sigorta sektöründe olumsuz bir etkiye neden olmadığı ve 2020-2021 dönemi ve onu takip eden dönemlerde verimlilikte bir artış yaşandığı görülmektedir.

## KAYNAKÇA

- Altun, H. (2006). Performans Değerlendirme ve Veri Zarflama Analizi. İstanbul: XYZ Yayınları.
- Banker, R. D., Conrad, R. F., & Strauss, R. P. (1986). A Comparative Application of Data Envelopment Analysis and Translog Methods: An Illustrative Study of Hospital Production. *Management Science*, 32(1), 30-44.
- Charnes, A., Cooper, W. W., & Rhodes, E. (1978). Measuring the Efficiency of Decision Making Units. *European Journal of Operational Research*, 2(6), 429-444.
- Charnes, A., Cooper, W. W., Lewin, A. Y., & Seiford, L. M. (2011). *Data Envelopment Analysis: Theory, Methodology, and Applications*. Springer Science & Business Media.
- Chu, P. C., & others. (2008). Veri Zarflama Analizi ve Uygulamaları. *İktisadi ve İdari Bilimler Fakültesi Dergisi*, 25(3), 15-27.
- Depren, K. (2008). Veri Zarflama Analizi ve Performans Değerlendirme. Ankara: ABC Yayınları.
- Erdal, A., & Erdal, B. (2015). Sigorta Hukuku. İstanbul: ABC Yayınları.
- Färe, R. (1985). *Measurement of Efficiency and Productivity*. Springer Science & Business Media.



V. INTERNATIONAL APPLIED STATISTICS CONGRESS (UYIK - 2024)  
İstanbul / Türkiye, May 21-23, 2024

- Güvel, A., & Güvel, N. (2002). Sigortacılığın Temelleri. İstanbul: ABC Yayınları.
- Kaya, M. (2021). Sigorta ve Bankacılık. Ankara: ABC Yayınları.
- Kayalidere, K., & Kargin, M. (2004). Karar Verme Sürecinde Veri Zarflama Analizi. *İstanbul Üniversitesi İşletme Fakültesi Dergisi*, 33(1), 45-60.
- Kotan, A. (2021). Bankaların Sigorta Sektöründeki Rolü. İstanbul: ABC Yayınları.
- Lewin, A. Y., Morey, R. C., & Cook, T. J. (1982). Evaluating the Administrative Efficiency of Courts. *Omega*, 10(4), 401-411.
- Orhaner, O. (2014). Türkiye'de Sigortacılığın Gelişimi. Ankara: XYZ Yayınları.
- Öztürk, M. (2009). Veri Zarflama Analizi ve Uygulamaları. İstanbul: ABC Yayınları.
- Satılmış, C. (2021). Sigorta Aracılığı ve Acentelik. Ankara: ABC Yayınları.
- Sherman, H. D., & Gold, F. (1985). Bank Branch Operating Efficiency: Evaluation with Data Envelopment Analysis. *Journal of Banking & Finance*, 9(2), 297-315.
- Thompson, R. G., Singleton, F. D., Thrall, R. M., & Smith, B. A. (1986). Comparative Site Evaluations for Locating a High-Energy Physics Lab in Texas. *Interfaces*, 16(6), 35-49.
- Türkiye Sigorta Birliği. (2022). 2022 Genel Kurul Faaliyet Raporu. Ankara: Türkiye Sigorta Birliği.



**The Relationship Between Foreign Direct Investment And Unemployment Rate In  
Türkiye: Evidence From The Fourier Toda-Yamamoto Test**

**Ömer Faruk Özyalçın<sup>1\*</sup>, Lütfü Sizer<sup>2</sup>**

<sup>1</sup> Karabük University, Faculty of Economics and Administrative Sciences, Economics, Karabük,  
Türkiye

<sup>2</sup> Dicle University, Faculty of Economics and Administrative Sciences, Economics, Diyarbakır,  
Türkiye

\*Corresponding author e-mail: omerfozyalcin@karabuk.edu.tr

**Abstract**

*To benefit from advantages such as cheap labor, tax exemptions, cheap raw materials, and avoidance of customs tariffs in exporting countries, multinational companies either build a new plant or buy an existing plant to produce in different countries. Generally, developing countries with deteriorating macroeconomic indicators try to attract foreign direct investment to solve their problems. Foreign direct investment can be realized not only through foreign currency inflows but also through technology, machinery, equipment, license agreements, etc. It is expected that the unemployment rate will be positively affected by the expectation that new workers will be hired due to the establishment of a new facility in the country of FDI or the change of ownership of an existing facility.*

*This study examines the long-run relationship between direct capital investments and unemployment in Türkiye using monthly data for the period 2001:1-2024:1. To examine the long-run relationship between the variables, Fourier-based tests are utilized since they are not affected by the date, number and form of structural breaks. The Fourier Toda-Yamamoto causality test developed by Nazlıoğlu et al. (2016) was applied to examine the relationship between the variables and a unidirectional causality relationship was found from FDI to unemployment.*

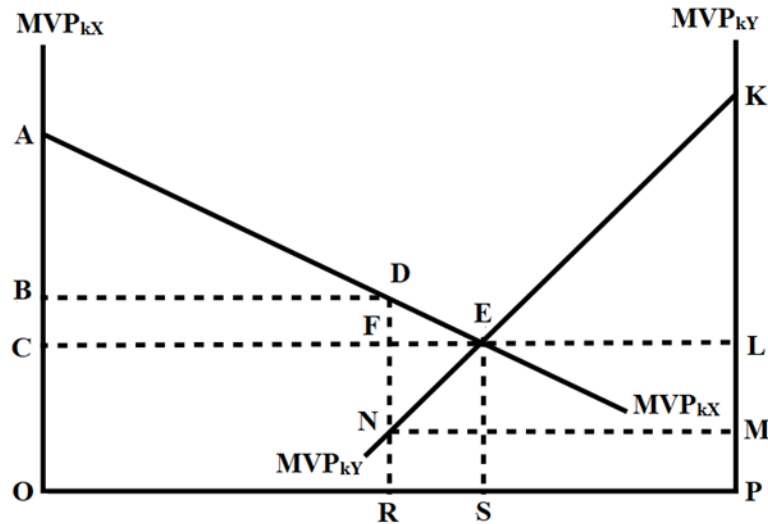
**Keywords:** Direct Capital Investments, Unemployment, Fourier Toda Yamamoto

**INTRODUCTION**

In order to benefit from advantages such as cheap labor, tax exemptions, cheap raw materials, and avoidance of customs tariffs in exporting countries, multinational companies either build a new plant or buy an existing plant to produce in different countries. Generally, developing countries with deteriorating macroeconomic indicators try to attract foreign direct investment in order to overcome these problems. Foreign direct investment (FDI) can be made not only in the form of foreign currency inflows but also in the form of technology, machinery, equipment, license agreements, etc. The unemployment rate is expected to be positively affected by the expectation that new workers will be hired due to the establishment of a new facility or the takeover of an existing facility in the country which is made foreign direct investment. This study analyzes the relationship between FDI and unemployment using monthly data for the period between 2005:M1 and 2024:M1 in Türkiye by Fourier Toda-Yamamoto causality analysis.

**THEORETICAL FRAMEWORK**

In Graph 1, it is analyzed the impact of FDI on unemployment under the assumption of the world with only X and Y countries.



**Figure 1.** The Effects of Foreign Direct Investment on Unemployment Rate (Seyidođlu 2015, 664)

In Figure 1, the horizontal axis is the world aggregate capital stock (OP), while  $MVP_{kX}$  and  $MVP_{kY}$  are the marginal product value curves for countries X and Y. In the first case, where capital is relatively scarce in country X and abundant in country Y, OS reflects the capital stock of country X and PS reflects the capital stock of country Y. The vertical axes denote the cost of capital in countries X and Y. In the first case, the capital cost of country X is OB and the capital cost of country Y is PM. FDI from country Y to country X reduces unemployment in country X through positive effects on aggregate output, wages and national income.

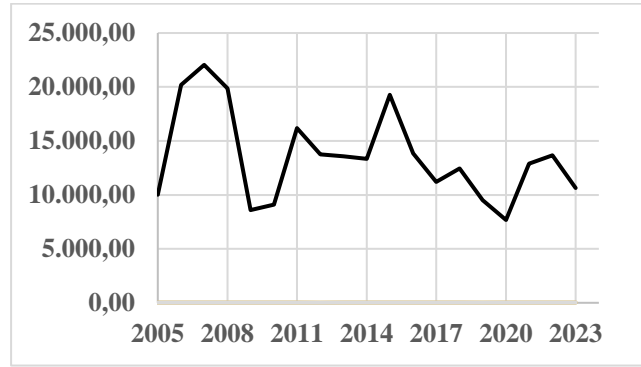
Firstly, if Graph 1 is analyzed in terms of total production, since foreign direct investment up to SR will be made from country Y to country X, the capital stock in country X increases and production increases accordingly. In the Figure, while production in country X was OADR before FDI arrived in the country, this area became OAES. In country Y, production decreased from PKNR area to PKES area. The increase in output in country X is higher than the decrease in output in country Y. This led to an increase in world output by the area of the DEN triangle.

Secondly, when wage changes are analyzed, in country Y with foreign capital outflow, the amount of capital per worker decreased and wage incomes decreased from the area of MKN to the area of LKE. In country X, where foreign capital inflows occurred, the amount of capital per worker increased and wage incomes increased from the area of the BAD triangle to the area of the CAE triangle.

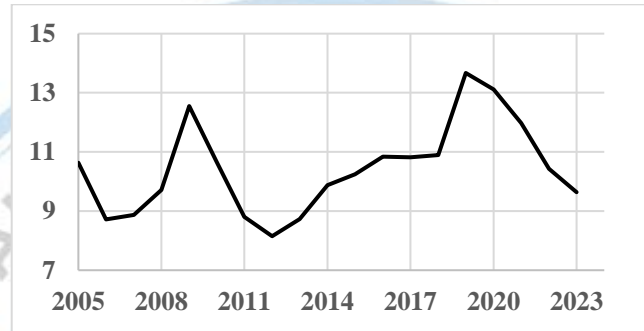
Thirdly, the case where FDI increases national income in the country of destination will be analyzed. National income is the sum of wage and capital income. Following the FDI, wage incomes in country X increased by the area of CBDE and capital incomes decreased by the area of CBDF. Since the increase in wage income is larger than the decrease in capital income by an area FDE, national income increases in country X. In country Y, total wages decreased by the area MLEN and capital income increased by the area MLFN. Therefore, national income increased by the area of NFE.

The January 24, 1980, decisions are a turning point in economic policies for Türkiye (Ertürk 1991, 147). One of these important decisions was to attract foreign capital to Türkiye. Accordingly, the Foreign Capital Framework Decree No. 8/168 entered into force on 25.1.1980 (Çeken 2003, 105). This decree is a cornerstone for the inflow of foreign direct capital investments into the country. Many amendments were made to this decree over the years and the aim was to increase the inflow of foreign direct capital investments into the country. Figure 2 and Figure 3 show how and in what direction the FDI and unemployment rates have changed over the years between 2005 and 2024.





**Figure 2.** Net Incurrence of Liabilities (Denominated in Million \$)



**Figure 3.** Unemployment Rate (%)

When Figure 2 and Figure 3 are analyzed together, the break years 2009, 2012, 2015, 2018, 2020, 2021 and 2022 in both Figures stand out. Therefore, it can be inferred that there may be a negative relationship between FDI and unemployment rates in Türkiye.

## LITERATURE

Noyan Yalman, Koşaroğlu investigated the impact of FDI on growth and employment using annual data for the period between 1988 and 2016 with the Toda-Yamamoto causality test and concluded that there is no causality relationship between them (Noyan Yalman and Koşaroğlu, 2017).

Erçakar, Güvenoğlu tested the effect of foreign direct investments on unemployment for Türkiye by using annual data for the period between 1980 and 2016 using Johansen cointegration test and Granger causality test. According to the Johansen cointegration test results, a negative and statistically significant relationship was found between FDI and unemployment in the long run. According to the Granger causality test results, no significant relationship was found between FDI and unemployment in the short run (Erçakar and Güvenoğlu, 2018).

Duman tested whether there is a causality relationship between foreign direct investments and foreign trade, economic growth and unemployment by using quarterly data for the period between 2000 and 2018 for Türkiye with Granger causality test. According to the statistically significant results, there is a bidirectional causality between FDI and foreign trade and economic growth, while there is a unidirectional but weak causality relationship between FDI and unemployment (Duman, 2019).

Korkmaz and Dastan investigated the relationship between FDI and unemployment for Türkiye using quarterly data for the period between the 4th quarter of 2005 and the 1st quarter of 2019 with Maki cointegration analysis and Toda-Yamamoto causality test. According to the test results, they found a unidirectional causality relationship from unemployment rate to FDI (Korkmaz and Daştan, 2020).

In their article, Ballı, Aydın tested the effect of FDI on economic growth and employment in Türkiye for the period between the 1st quarter of 2006 and the 2nd quarter of 2021 with the Autoregressive

Distributed Lag model (ARDL) and a possible causality relationship between them with the Toda-Yamamoto causality test. According to the significant results of the analysis, the causality between the variables is bidirectional (Ballı and Aydın, 2022).

In their article, Tütüncü Hasbi, Evlimoğlu comparatively analyzed the impact of foreign direct investments on growth and unemployment rates in 15 developed and 15 developing countries by using annual data for the period between 1993 and 2018 with the panel data analysis method. According to the results obtained from the empirical study, they concluded that FDI inflows to Türkiye do not have a significant effect on unemployment (Tütüncü Hasbi and Evlimoğlu, 2023).

Yöyen analyzed the relationship between FDI and portfolio investments and unemployment rate for Türkiye using annual data for the period between 1990 and 2022 with Toda-Yamamoto causality test. According to the significant results of the test, there is a bidirectional causality relationship between FDI and unemployment rate, and a unidirectional causality relationship from portfolio investments to unemployment rate (Yöyen, 2023).

This study differs from previous studies in terms of the period covered by the analysis, the difference in the methodology and its power.

## MATERIAL AND METHODS

### Material

The foreign direct investment (FDI) variable used in the analysis was obtained from the World Bank database and the data on Unemployment (UNEMP) variable was obtained from the ILO (International Labour Organization) database. Monthly data for the period 2005:M1-2024:M1 are used in the study. In addition, the natural logarithms of the variables used were taken and included in the analysis

### Methods

A pioneering study by Perron (1989) reveals the consequences of ignoring structural breaks when testing the stationarity of series. If structural breaks are not taken into account, unit root tests may give misleading results when the data generating mechanism has structural breaks. Moreover, structural breaks not only affect the results of unit root tests but also the results of cointegration tests. The cointegration tests developed by Gregory and Hansen (1996) and Hatemi-J (2008) allow for structural breaks when analyzing long-term relationships. However, these studies have shown that predetermining the number of structural breaks can lead to misleading results, as allowing more or fewer structural breaks during the data construction process can bias the results. These tests model structural changes through dummy variables, but these variables only allow for sudden changes and fail to model slower changes. In this study, we avoid these shortcomings by using the cointegration test introduced by Banerjee et al. (2017) (Yılcı et al., 2020).

Gallant (1981) and Gallant and Souza (1991) showed that the Fourier approach can detect multiple breaks. After Becker et al. (2006) used Fourier functions to test the stationarity of series, the use of Fourier functions in unit root analysis has become widespread. Enders and Lee (2012) and Rodrigues and Taylor (2012) also used Fourier functions in their studies allowing for structural breaks.

### *Güriş (2019) Fourier-Kruse Unit Root Test*

The Fourier Kruse unit root test, introduced to the literature by Güriş (2019) in his article, is a unit root test that incorporates the effect of structural change in case of nonlinearity in the series into the model with Fourier approximations. The test procedure is defined as a combination of Fourier functions and the ESTAR (exponential smooth threshold autoregressive) model structure developed by Kruse (2011). This test has been introduced in the literature as the Güriş (2019) test by combining the Kruse (2011) test, which is an improvement of the KSS (Kapetanios, Shin and Snell) (2003) test, which allows for the examination of unit root for nonlinear series, and the Christopoulos and Leon-Ledesma (2010) test, which incorporates an unknown form and number of structural changes into the analysis. The test procedure consists of 3 stages:

In the first stage, taking into account the nonlinear deterministic components reflecting different forms and numbers of structural changes, the series is estimated by Fourier function as follows:

$$Y_t = \beta_0 + \beta_1 \sin\left(\frac{2\pi kt}{T}\right) + \beta_2 \cos\left(\frac{2\pi kt}{T}\right) + w_t$$

The  $k$  in the function indicates the optimal number of frequencies determined at the value where the sum of residual squares (SSR) of the model is minimum.  $T$  is the number of observations. By estimating this model, the error terms  $w_t$  are obtained:

$$w_t = Y_t - \beta_0 - \beta_1 \sin\left(\frac{2\pi kt}{T}\right) - \beta_2 \cos\left(\frac{2\pi kt}{T}\right)$$

In the second stage, using the error terms  $w_t$ ,

$$\Delta w_t = \gamma_1 w_{t-1}^3 + \gamma_2 w_{t-1}^2 + \sum_{j=1}^p \phi_j \Delta w_{t-j} + e_t$$

The ESTAR model is estimated and the test statistic is calculated to test the null hypothesis  $H_0: \gamma_1 = \gamma_2 = 0$  against the alternative hypothesis  $H_1: \gamma_1 < 0, \gamma_2 \neq 0$ , which states that the series has a unit root.

In the third stage, the test statistic is compared with Güriş (2019) table values. If the null hypothesis of a unit root is rejected, the series is stationary. At this stage, the significance of the trigonometric terms in the Fourier function is tested with the F test, which is defined as  $H_0: \beta_1 = \beta_2 = 0$  indicating the null hypothesis. This test statistic is interpreted by comparing it with the Becker, Enders and Lee (2006) table values. If the null hypothesis of the F test statistic is rejected, the series is said to be stationary with a deterministic function with breaks (Güriş, 2019: 3057-3058).

#### Fourier Toda-Yamamoto Causality Test

Toda and Yamamoto (1995) add a lag of the maximum unit root degree to a vector autoregressive model with level values of the variables. This is because the Wald test depends on dummy parameters when the variable is non-stationary. This change in the Wald test eliminates the problems of the Granger causality test by ignoring the non-stationarity of the series and the presence of cointegration (Amiri and Ventelou, 2012: 542; Nazlıoğlu and Soyaş, 2024: 6).

After Enders and Jones (2016) added Fourier terms to the Granger causality test, Nazlıoğlu et al. (2016) also added Fourier terms to the Toda-Yamamoto causality test.

$$y_t = y_0 + y_1 \sin\left(\frac{2\pi kt}{T}\right) + y_2 \cos\left(\frac{2\pi kt}{T}\right) + \phi_1 y_{t-1} + \dots + \phi_{p+d} y_{t-(p+d)} + \mu_t$$

The terms  $\sin$  and  $\cos$  denote Fourier trigonometric terms; the term  $p$  denotes the number of lags determined according to the information criteria; and the term  $d$  denotes the highest order stationarity of the variables. After determining the integer frequency value, the causality test is applied with the help of lag length and  $d$  parameter as in equation (5). The null hypothesis of the test is no causality ( $H_0: \phi_1 = \dots = \phi_n = 0$ ). A causal relationship is identified by rejecting the null hypothesis as a probability value (Payne et al., 2020: 20).

## RESULTS

Before proceeding with the Toda-Yamamoto causality test results, it is necessary to determine the degree to which the variables are integrated. For this purpose, ADF unit root test, which is the traditional unit root test frequently used in the literature, and Fourier Kruse unit root tests that take into account structural breaks were used. The unit root test results are presented in Tables 1 and 2.

**Table 1.** Results of the ADF Unit Root Test

Variables	Constant		Constant and Trend	
	Test Statistic	5% Critical Value	Test Statistic	5% Critical Value
FDI	-4.853** (4)	-2.874	-5.010** (4)	-3.430
UNEMP	-1.438 (0)	-2.874	-1.132 (0)	-3.429
$\Delta$ UNEMP	-13.708** (0)	-2.874	-13.745** (0)	-3.429

**Note:** \*\* indicates significance at 5% significance level. The values in parentheses indicate the appropriate lag length determined according to the Schwarz (SIC) information criteria.



**Table 2.** Güriş (2019) Fourier Kruse Unit Root Test Results

Variables	Model With Constant				Model With Constant and Trend			
	k*	Lag Length	Fourier-Kruse Test St.	F-St.	k**	Lag Length	Fourier-Kruse Test St.	Lag Length
FDI	4	1	29.85	5.86	4	1	28.71	6.06
UNEMP	2	1	9.33	3.27	2	1	10.46	95.73

\*F-kr=11.92,  $F_m(k) = 4.651$  at 5% significance level for the model with constant term for k=2

\*\* F-kr= 15.74,  $F_m(k) = 4.651$  at 5% significance level for the model with constant and trend term for k=2

\* F-kr= 10.74,  $F_m(k) = 4.651$  at 5% significance level for the model with constant term for k=4

\*\* F-kr= 13.88,  $F_m(k) = 4.651$  at 5% significance level for the model with constant and trend term for k=4

According to the results obtained in Tables 1 and 2, according to the ADF and Fourier Kruse unit root tests, the FDI variable is stationary at level in both the constant and the constant and trended model. Similarly, according to both ADF and Fourier Kruse unit root tests, the unemployment variable was found to be non-stationary at level values both in the model with constant and in the model with constant and trend. However, it became stationary after taking the first difference of the series. Therefore, the maximum lag length for the VAR model is calculated as  $d_{max} = 1$ .

In addition, the appropriate lag length for the VAR model was determined by looking at the Likelihood Ratio (LR), FPE, Akaike (AIC) and Schwarz (SC) information criteria. The results obtained according to these information criteria are given in the table below.

**Table 3.** Determination of Appropriate Lag Length for VAR Model

Lag	LR	FPE	AIC	SC
0	NA	0.007228	0.745901	0.777567
1	689.3717	0.000277	-2.514792	-2.419794*
2	5.980146	0.000280	-2.505946	-2.347616
3	7.787880	0.000280	-2.506200	-2.284538
4	7.028368	0.000281	-2.503086	-2.218093
5	17.79238*	0.000267*	-2.553870*	-2.205545

\* Indicates the optimal lag length.

In Table 3, the lowest value according to all information criteria indicates that the model with 5 lags is appropriate. In other words, the lag length to be used in the model is determined as k=5. After determining the lag length, the Autocorrelation LM test was performed to determine whether there is an autocorrelation problem according to the lag length determined. As can be seen from Table 4, there is no autocorrelation problem.

**Table 4.** Autocorrelation LM Test Results

Lag	LM-Statistic	Prob.
1	2.172343	0.7041
2	4.337878	0.3622
3	1.082395	0.8971
4	4.200763	0.3795
5	4.017491	0.4036

Moreover, considering the chosen lag length, it should be tested whether the error terms of the VAR model contain autocorrelation problem. The autocorrelation problem may cause deviations in the estimated parameters and lead to erroneous findings. For this purpose, the inverse roots of the error term of the estimated model can be examined. If the error term is not autocorrelated, the inverse roots should be less than 1. The following table shows the results of the inverse roots of the error terms.

**Table 5.** Inverse Roots of Error Terms

Root	Modulus
0.904668 - 0.041604i	0.905624
0.904668 + 0.041604i	0.905624
-0.609519 - 0.498826i	0.787618
-0.609519 + 0.498826i	0.787618
0.709221	0.709221

As can be seen from Table 5, the inverse roots of the error terms are smaller than 1, which means that the model is dynamically consistent. Therefore, since no problems are detected in the preliminary tests to perform the Toda-Yamamoto causality test, causality analysis can be performed.

Therefore, according to the unit root test and VAR lag length results, the  $k + d_{max}$  value required for the Toda-Yamamoto causality test is 6. The results of the Toda-Yamamoto causality test obtained by taking these conditions into account are given in Table 6 below.

**Table 6.** Toda-Yamamoto Causality Test Results

Direction Of Causality	Lag Length	$\chi^2$ Test Statistic Value	Prob. Value
FDI $\rightarrow$ UNEMP	$(k=5)+(d_{max} = 1) = 6$	9.215	0.14
UNEMP $\rightarrow$ FDI	$(k=5)+(d_{max} = 1) = 6$	7.852	0.249

As can be seen from Table 6, the null hypothesis cannot be rejected since the probability value of the calculated  $\chi^2$  test statistic is greater than 0.05. In other words, there is no Granger causality relationship from FDI to unemployment at the 5% significance level. Similarly, since the probability value of the  $\chi^2$  test statistic calculated from unemployment to FDI is greater than 0.05, the null hypothesis cannot be rejected. In other words, there is no Granger causality relationship from unemployment to FDI at 5% significance level. Therefore, according to the toda yamamoto causality test, there is no causal relationship between the variables.

**Table 7.** Fourier Toda-Yamamoto Causality Test Results

Direction Of Causality	Lag Length	$\chi^2$ Test Statistic Value	Prob. Value
FDI $\rightarrow$ UNEMP	$(k=5)+(d_{max} = 1) = 6$	7.31	0.050
UNEMP $\rightarrow$ FDI	$(k=5)+(d_{max} = 1) = 6$	4.92	0.13

As can be seen in Table 7, the null hypothesis is rejected since the probability value of the calculated  $\chi^2$  test statistic is less than 0.05. In other words, there is a Granger causality relationship from FDI to unemployment at 5% significance level. Similarly, since the probability value of the  $\chi^2$  test statistic value calculated from unemployment to FDI is greater than 0.05, the null hypothesis cannot be rejected. In other words, there is no Granger causality relationship from unemployment to FDI at 5% significance level. Therefore, according to the fourier toda yamamoto causality test, there is a unidirectional causal relationship between the variables from FDI to unemployment.

In sum, it can be concluded that the Fourier Toda and Yamamoto method, which takes into account the presence of breaks, provides more realistic results than the traditional Toda Yamamoto causality test. Our results also suggest that it is crucial for academics and policymakers to apply relevant methods that take into account the presence of possible structural breaks in order to have a more reliable inference on the link between economic variables.

## DISCUSSION AND CONCLUSION

In this study, the relationship between foreign direct investment and unemployment in Türkiye is analyzed using monthly data for the period 2005M1-2024M1. Econometric methods based on Fourier functions that take structural breaks into account are used. Because ignoring structural changes in countries with a fragile structure like Türkiye may lead to misleading results and wrong policy measures. In this framework, Fourier TY causality test was applied for the causality relationship between variables and according to the findings, it was found that there is a unidirectional causality relationship from FDI

to unemployment. As a developing country, Turkey faces many macroeconomic problems such as unstable growth rates, budget deficit, high inflation, volatile exchange rates and unemployment. Therefore, it is of great importance to attract foreign direct investment to the country. Therefore, determining whether FDI contributes to the solution of the unemployment problem is an important guide for policy makers.

#### References

- Ballı, P. E., & Aydın, A. (2022). Türkiye’de doğrudan yabancı yatırımların ekonomik büyüme ve istihdama etkisi. *Journal of Empirical Economics and Social Sciences*, 4(2), 39–60.
- Banerjee, P., Arčabić, V., & Lee, H. (2017). Fourier ADL cointegration test to approximate smooth breaks with new evidence from crude oil market. *Economic Modelling*, 67, 114-124.
- Becker, R., Enders, W., & Lee, J. (2006). A stationarity test in the presence of an unknown number of smooth breaks. *Journal of Time Series Analysis*, 27(3), 381-409.
- Çeken, H. (2003). *Küreselleşme, yabancı sermaye ve Türkiye turizmi* (1st ed.). İstanbul: Değişim Yayınları.
- Duman, E. (2019). Journal of Institute of Economic Development and Social Researches. *Journal of Institute of Economic Development and Social Researches*, 5(19), 239–248. Retrieved from <https://dergipark.org.tr/tr/pub/ikasad/issue/51699/671181>
- Enders, W., & Lee, J. (2012). A unit root test using a Fourier series to approximate smooth breaks. *Oxford Bulletin of Economics and Statistics*, 74(4), 574-599.
- Erçakar, M. E., & Güvenoğlu, H. (2018). Doğrudan yabancı yatırımların işsizlik üzerine etkisi: Türkiye uygulaması (1980-2016). *Anemon Muş Alparslan Üniversitesi Sosyal Bilimler Dergisi*, 6, 349–356.
- Ertürk, E. (1991). *Türkiye iktisadında yeni bir boyut, para ikamesi: Kavram, teori, oluşum süreci ve sonuçları* (1st ed.). Bursa: Uludağ Yayınları.
- Gallant, A. R. (1981). On the bias in flexible functional forms and an essentially unbiased form: The Fourier flexible form. *Journal of Econometrics*, 15(2), 211-245.
- Gallant, A. R., & Souza, G. (1991). On the asymptotic normality of Fourier flexible form estimates. *Journal of Econometrics*, 50(3), 329-353.
- Güriş, B. (2019). A new nonlinear unit root test with Fourier function. *Communications in Statistics-Simulation and Computation*, 48(10), 3056-3062.
- Gregory, A. W., & Hansen, B. E. (1996). Residual-based tests for cointegration in models with regime shifts. *Journal of Econometrics*, 70(1), 99-126.
- Hatemi-j, A. (2008). Tests for cointegration with two unknown regime shifts with an application to financial market integration. *Empirical Economics*, 35(3), 497-505.
- Korkmaz, Ö., & Daştan, B. (2020). Türkiye’de doğrudan yabancı yatırımlar ile işsizlik oranı arasındaki ilişki (2005-2019). *International Journal of Economics, Politics, Humanities & Social Sciences*, 3(4), 260–279.
- Noyan Yalman, İ., & Koşaroğlu, Ş. M. (2017). Doğrudan yabancı yatırımların ekonomik büyüme ve işsizlik üzerindeki etkisi. *Uluslararası Ekonomi İşletme ve Politika Dergisi*, 1(2), 191–205.
- Perron, P. (1989). The great crash, the oil price shock, and the unit root hypothesis. *Econometrica*, 57(6), 1361-1401.
- Rodrigues, P. M., & Taylor, A. M. R. (2012). The Flexible Fourier Form and local generalised least squares de-trended unit root tests. *Oxford Bulletin of Economics and Statistics*, 74(5), 736-759.
- Seyidoğlu, H. (2015). *Uluslararası iktisat: Teori politika ve uygulama* (20th ed.). İstanbul: Güzem Can Yayınları.
- Yılancı, V., İslamoğlu, E., Yıldırım, S., & Candan, G. (2020). The relationship between unemployment rates and renewable energy consumption: Evidence from Fourier ADL cointegration test. *Alphanumeric Journal*, 8(1), 17-28.
- Yöyen, H. T. (2023). Türkiye’de doğrudan yabancı yatırımlar ve portföy yatırımları işsizlik oranları üzerinde etkili mi? Toda-Yamamoto nedensellik analizi. *International Journal of Applied Economic and Finance Studies*, 8(2), 51–61.

#### Conflict of Interest

"The authors have declared that there is no conflict of interest".

#### Author Contributions

The contribution rate of the authors is equal.



## New Developments in Statistical Physics and Its Applications in Technology

B. A. Mamedov<sup>1</sup>

<sup>1</sup>Department of Physics, Faculty of Arts and Sciences, Gaziosmanpasa University, Tokat, Türkiye

\*Corresponding author e-mail: [bamamedov@yahoo.com](mailto:bamamedov@yahoo.com)

### *Abstract*

*Statistical physics finds applications in a wide range of fields, owing to its ability to describe the behavior of systems with a large number of interacting components. Its principles and methods are employed in numerous other fields, including chemistry, economics, sociology, and computer science, making it a versatile and powerful tool for understanding the behavior of complex systems. Determining the distribution of fermions and bosons according to statistical physics has provided significant progress in the examination of many properties of matter. Note that, although the statistical foundations of the physics of solids, plasma, and gases are known, a consistent microscopic statistical theory of liquid awaits its creator for more than a hundred years. In this study, current developments in statistical physics, which has an important contribution to the development of science and engineering industries, are examined.*

**Keywords:** *Statistical Physics, Thermodynamics, Semiconductors, Diodes, Materials, Electronics*

### **INTRODUCTION**

The historical development of statistical physics is a fascinating journey that spans several centuries, involving contributions from many notable scientists. Here's a brief overview of key milestones in the history of statistical physics [1]. The foundations of probability theory, a crucial tool in statistical physics, were laid down by mathematicians such as Blaise Pascal and Pierre de Fermat in the 17th century. Probability theory provided the mathematical framework for understanding random processes and uncertainty. In the early 19th century, scientists like John Herapath, John James Waterston, and August Krönig independently proposed kinetic theories of gases, which suggested that gases consist of molecules in motion. This laid the groundwork for the statistical understanding of thermodynamics. James Clerk Maxwell and Ludwig Boltzmann made significant contributions to the development of statistical mechanics in the latter half of the 19th century. Boltzmann formulated the statistical definition of entropy and derived the Boltzmann distribution, which describes the statistical behavior of particles in a gas [1-6]. The development of quantum mechanics in the early 20th century revolutionized statistical physics. Max Planck's quantum hypothesis and the subsequent development of quantum mechanics by pioneers like Niels Bohr, Werner Heisenberg, and Erwin Schrödinger provided a new framework for understanding the behavior of particles at the atomic and subatomic levels. Satyendra Nath Bose and Albert Einstein introduced Bose-Einstein statistics and Fermi-Dirac statistics, respectively, to describe the behavior of particles with integer and half-integer spin. These statistical distributions are fundamental in understanding the behavior of particles in quantum systems. In the mid-20th century, the formalism of statistical thermodynamics was further developed by scientists such as Lars Onsager and Ilya Prigogine. They extended statistical mechanics to describe non-equilibrium systems, phase transitions, and complex phenomena far from equilibrium. The invention of the Monte Carlo method by Stanislaw Ulam and John von Neumann in the 1940s revolutionized statistical physics by providing a powerful computational tool for simulating complex systems and solving statistical problems. In recent decades, statistical physics has played a crucial role in the study of complex systems, including biological networks, social systems, and financial markets. Tools and concepts from statistical physics,

such as network theory and stochastic processes, have been applied to understand emergent phenomena in complex systems [7, 8].

Black body radiation is a fundamental concept in both statistical physics and quantum mechanics. It refers to the electromagnetic radiation emitted by a perfect absorber (a black body) at thermal equilibrium. The study of black body radiation played a crucial role in the development of quantum theory in the early 20th century, particularly with Max Planck's groundbreaking work. Classically, according to classical electromagnetism, one would expect that a black body at thermal equilibrium would emit an infinite amount of energy at all frequencies, which contradicted experimental observations. This discrepancy between theory and experiment became known as the ultraviolet catastrophe.

Max Planck proposed a revolutionary idea in 1900 to resolve this discrepancy. He postulated that the energy of oscillators in the black body cavity was quantized, meaning they could only emit or absorb energy in discrete packets or "quanta". This was a departure from classical physics, where energy was considered continuous. Planck introduced the Planck constant  $h$  to quantify this quantization [7,8]. Planck's hypothesis led to the development of what is now known as Bose-Einstein statistics. Essentially, it describes the distribution of identical particles (bosons) in a system. In the case of black body radiation, photons (the quanta of electromagnetic radiation) are treated as particles obeying Bose-Einstein statistics. Using statistical mechanics and the principles of Bose-Einstein statistics, Planck derived a formula for the spectral radiance of a black body as a function of frequency and temperature. This formula, known as Planck's law, accurately describes the observed spectrum of black body radiation across a wide range of frequencies and temperatures.

Planck's work on black body radiation provided one of the first experimental validations of the quantization of energy and the particle-like nature of light. It laid the foundation for the development of quantum mechanics, as subsequent physicists like Albert Einstein and Niels Bohr further developed the theory of photons and quantum mechanics. In summary, black body radiation is a phenomenon that is deeply rooted in both statistical physics and quantum mechanics. It highlights the interplay between thermal equilibrium, quantization of energy, and the statistical behavior of particles, leading to some of the most significant advancements in physics in the 20th century.

Throughout its history, statistical physics has evolved from a theoretical framework for understanding the behavior of gases to a powerful interdisciplinary field with applications in diverse areas of science and engineering. It continues to be at the forefront of scientific research, contributing to our understanding of fundamental physical principles and complex systems.

## **2. The importance of statistical physics in modern technology**

Statistical physics finds applications in a wide range of fields, owing to its ability to describe the behavior of systems with a large number of interacting components. Some key applications include Condensed Matter Physics, Thermodynamics and Heat Transfer, Biophysics, Materials Science and Nanotechnology, Astrophysics and Cosmology, Non-equilibrium Statistical Physics, Quantum Statistical Physics, Machine Learning and Statistical Physics, Complex Systems and Networks, Soft Matter and Active Matter [9-21].

Statistical physics provides the theoretical framework for understanding the properties of condensed matter systems such as solids, liquids, and gases. It explains phenomena such as phase transitions, magnetism, superconductivity, and the behavior of materials at different temperatures and pressures. Thermodynamics, a branch of statistical physics, underpins many engineering applications related to energy conversion and heat transfer. It provides the theoretical basis for the design and optimization of engines, refrigeration systems, and power plants. Statistical physics also plays a role in understanding

phenomena like heat conduction in materials and phase transitions in fluids [1-3]. Renormalization group theory continues to be a cornerstone of theoretical physics, with ongoing developments in both its conceptual foundations and its applications to various physical systems, including condensed matter systems and quantum field theory.

Statistical physics is used to study the behavior of biological systems at the molecular and cellular levels. It helps understand protein folding, DNA structure, membrane dynamics, and the collective behavior of biological networks. Techniques from statistical physics are also applied to modeling biological processes such as gene regulation and neural networks [14].

Statistical physics informs the design and characterization of materials at the nanoscale. It helps predict the properties of nanomaterials, such as their electronic, magnetic, and mechanical behavior. Statistical physics also plays a role in understanding phenomena like quantum confinement effects, surface phenomena, and self-assembly processes in nanomaterials. Statistical physics is used to model the behavior of matter and radiation in astrophysical systems such as stars, galaxies, and the early universe. It helps explain phenomena like stellar evolution, the formation of galaxies, and the cosmic microwave background radiation. Understanding systems far from equilibrium has been a major focus. This includes research into non-equilibrium phase transitions, such as directed percolation, and the development of new theoretical frameworks like the fluctuation theorem and the theory of stochastic thermodynamics [11-13].

With the rise of quantum technologies, there has been significant interest in applying statistical physics to quantum systems. This includes research into quantum phase transitions, quantum entanglement, and the statistical mechanics of quantum gases and fluids. There's a growing intersection between machine learning and statistical physics. Techniques from statistical physics, such as Monte Carlo methods and mean-field theories, are being used to understand complex systems in machine learning, while machine learning methods are being applied to problems in statistical physics, such as identifying phase transitions and learning effective models from data [12-13].

Statistical physics is increasingly applied to the study of complex systems, including networks, biological systems, and social systems. Research in this area includes the study of critical phenomena in complex networks, the dynamics of biological systems using methods from statistical physics, and the modeling of opinion dynamics and social contagion. There has been significant progress in understanding topological phases of matter and many-body localization, which are phenomena that arise in strongly correlated quantum systems. Statistical physics provides powerful tools for characterizing and understanding these exotic phases of matter.

Statistical physics plays a central role in the study of soft matter and active matter systems, such as colloidal suspensions, polymers, and active biological materials. Recent research in this area includes the study of phase transitions and emergent behavior in active systems driven out of equilibrium [14, 16].

In this work, these are just a few examples of the recent developments in statistical physics. The field is highly interdisciplinary, with connections to mathematics, computer science, biology, and other areas, and it continues to evolve rapidly with new experimental discoveries and theoretical insights.

#### **Conflict of Interest**

The authors have declared that there is no conflict of interest.

#### **References**

1. Isihara, A. (2013). *Statistical physics*. Academic Press.
2. Salinas, S. (2013). *Introduction to statistical physics*. Springer Science & Business Media.



3. Kittel, C. (2004). *Elementary statistical physics*. Courier Corporation.
4. Kubo, R., Toda, M., & Hashitsume, N. (2012). *Statistical physics II: nonequilibrium statistical mechanics* (Vol. 31). Springer Science & Business Media.
5. Guttman, Y. M. (1999). *The concept of probability in statistical physics*. Cambridge University Press.
6. Reichl, L. E. (2016). *A modern course in statistical physics*. John Wiley & Sons.
7. Zeilinger, A. (1999). Experiment and the foundations of quantum physics. *Reviews of Modern Physics*, 71(2), S288.
8. French, A. P. (2018). *An introduction to quantum physics*. Routledge.
9. Stanley, H. Eugene. "Exotic statistical physics: Applications to biology, medicine, and economics." *Physica A: Statistical Mechanics and its Applications* 285.1-2 (2000): 1-17.
10. Lux, Thomas. "Applications of statistical physics in finance and economics." *Handbook of research on complexity*. Edward Elgar Publishing, 2009.
11. Wegner, Franz. "Supermathematics and its applications in statistical physics." *Lecture notes in Physics* 920 (2016).
12. Janke, Wolfhard. "Monte Carlo simulations in statistical physics—From basic principles to advanced applications." *Order, Disorder and Criticality: Advanced Problems of Phase Transition Theory Volume 3*. 2013. 93-166.
13. Gould, Harvey, and Jan Tobochnik. *Statistical and thermal physics: with computer applications*. Princeton University Press, 2021.
14. Parisi, G. (1993). Statistical physics and biology. *Physics World*, 6(9), 42.
15. Krapivsky, P. L., & Redner, S. (2002). A statistical physics perspective on Web growth. *Computer Networks*, 39(3), 261-276.
16. Mézard, M., & Mora, T. (2009). Constraint satisfaction problems and neural networks: A statistical physics perspective. *Journal of Physiology-Paris*, 103(1-2), 107-113.
17. Kardar, M. (2007). *Statistical physics of particles*. Cambridge University Press.
18. Merhav, N. (2010). Statistical physics and information theory. *Foundations and Trends® in Communications and Information Theory*, 6(1–2), 1-212.
19. Fan, J., Meng, J., Ludescher, J., Chen, X., Ashkenazy, Y., Kurths, J., ... & Schellnhuber, H. J. (2021). Statistical physics approaches to the complex Earth system. *Physics reports*, 896, 1-84.
20. Lee, J. S., Lee, S., & Noh, T. W. (2015). Resistive switching phenomena: A review of statistical physics approaches. *Applied Physics Reviews*, 2(3).
21. Röpke, G. (2013). *Nonequilibrium statistical physics*. John Wiley & Sons.

## Explainable Artificial Intelligence Applications in Predicting Injury Risks of Athletes

**Eyüp Ensar Işık<sup>1\*</sup>, Gülşah Şahin<sup>1</sup>, Mehmet Soydan<sup>1</sup>**

<sup>1</sup>Yildiz Technical University, Faculty of Mechanical Engineering, Industrial Engineering Department,  
34349, İstanbul, Türkiye

\*Corresponding author e-mail: eeisik@yildiz.edu.tr

### Abstract

*The physical health of athletes participating in competitive sports events significantly affects their success in competitions. On the other hand, with the industrialization of sports, the increase in investments in this field brings the expectation of success. Thus, a significant part of the investments is spent on protecting the physical health of athletes, who are the most critical actors in this field. In this context, accurate prediction of injuries that may occur by considering the various characteristics of athletes is essential for both the players' sustainable career planning and the teams' goals. However, as well as predicting the injury status of athletes with high accuracy, it is also essential that the model used is explainable and that the features that most affect the prediction results are revealed. In this way, the action to be taken by the athlete, who is predicted to have a possibility of injury, and the decisions that the club managers will make about the athlete can be determined. In this study, the likelihood of the player experiencing an injury will be predicted using various machine learning models, considering factors such as athletes' physical characteristics, injury history, training intensity, and recovery time. The models used will be compared, considering their accuracy of prediction as well as their explainability. Thanks to the comparative analyses presented as a result of the study, guiding results will be provided for decision-makers to choose the most suitable one among models with different prediction accuracy and explainability levels.*

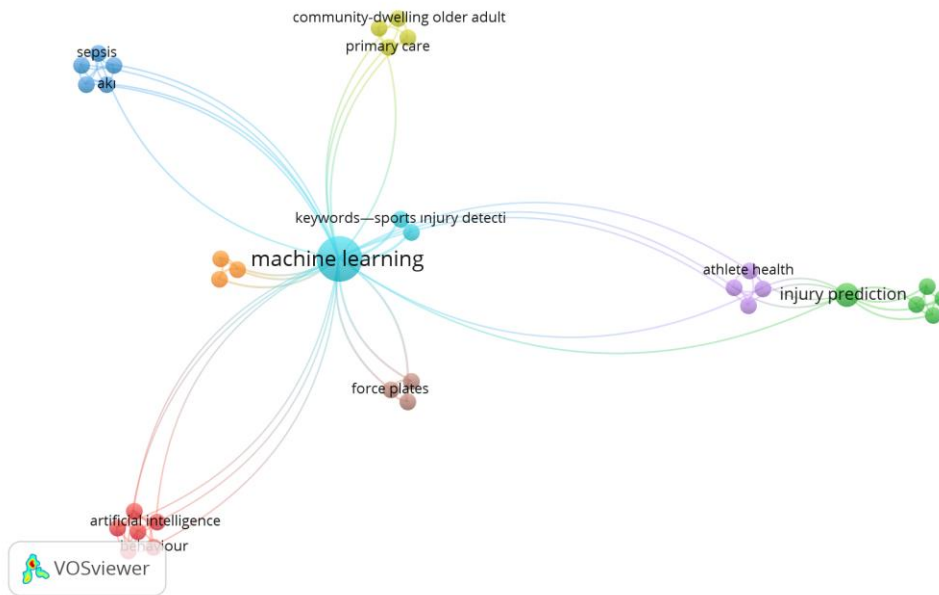
**Keywords:** Injury Prediction, Machine Learning, Explainable Artificial Intelligence

### INTRODUCTION

Sports have numerous benefits for the individual, yet it is also known that sports can give rise to a situation of significant risk, with the potential to have a profound impact on the athlete's professional and personal life: injury (Theadom et al., 2020; Andrade et al., 2020). While the long-term or frequent injury of the athlete has a negative impact on the success and economy of sports clubs, it can also have a negative effect on the athlete physically, emotionally, and financially (Pu et al., 2023). Injury has a negative impact not only on individual performance in sports but also on team performance due to athletes being away from the team (Majumdar et al., 2022). In team sports, the incidence of injuries during the season is linked to the success of teams, which is a factor that often prompts management to focus on this issue (Maupin et al., 2020). Injury prevention is a crucial concern for team managers, who seek to minimize the financial impact of injuries on the team's overall expenditure (Eliakim et al., 2020). Therefore, it is essential to identify players who are likely to suffer injury.

Machine learning is used in many areas for prediction and classification purposes. In sports, it is used in many subheadings, such as consumer behavior, match result prediction, and social media (Du et al., 2023a; Rodrigues and Pinto, 2022; Du et al., 2023b). In addition, it is a frequently used method for injury prediction. Analyses such as XGBoost, random forest, gradient boosting, neural networks, and naive Bayes can provide high accuracy rates. (Van Eetvelde et al., 2021). However, the explainability of the model is as important as the correct prediction of the results. An explainable model will be more helpful to the coach and athlete to make a training program and the risk to be taken (Hudson et al., 2021).

To start our literature review, first, we searched the Scopus database with the keywords ("injury\_prediction" AND ("explainable\_artificial\_intelligence" OR "XAI")) and we found only one single study. Upon examining the study, we determined that the subject was unrelated to the subject under investigation. Afterward, we arranged the keywords as ((injury\_prediction) AND ("machine\_learning" OR "artificial\_intelligence")) and examined the obtained studies. The co-occurrence of keywords in the obtained studies was examined using VOSviewer, as shown in Figure 1.



**Figure 7.** Network visualization of keywords co-occurrence in studies

In their study, Salian et al. (2024) collected videos of athletic runners from competition and training, including 100m, 200m, 4x100m, and 1500m races. In constructing the dataset, they paid particular attention to capturing differences in an athlete's running style in various contexts, including both injured and uninjured situations, and to integrating time components by including previous race results. This strategy resulted in a comprehensive dataset that captures the subtleties of an athlete's running style, injury history, and possible technical development over time.

Dandrieux et al. (2023) aimed to analyze the relationship between the level of use of Injury Risk Predictive Feedback and injury complaints leading to the burden of participation restriction during the athletic season. A prospective cohort study, Injury Prediction with Artificial Intelligence, was conducted over a 38-week athletics season involving competitive track and field athletes licensed by the French Athletics Federation. The study is the first to use a machine learning model to predict injuries in real-time on the sports field. In another study, Rossi et al. (2022) estimated the health status of 17 Serie A players in the Italian Championship. In addition to the Global Positioning System (GPS) data recorded during training and matches, fatigue, sleep, stress, and soreness data from the survey and the rate of perceived exercise were also used for estimation. The findings of this study indicate that it is possible to accurately predict players' perceived health status by considering their workload history as input.

In this study, we use machine learning methods to predict the injury situation of athletes. We aim to determine the optimum model by comparing black-box methods that offer possible high accuracy rates and glass-box methods that provide self-explanatory models.

In this section, we introduce the subject of the study and discuss similar studies in the literature. In Section 2, we present glass-box and black-box models, explain the techniques we used, and introduce our data set. Section 3 provides information about our methodology and presents our computational results. Lastly, in Section 4, we conclude our study and present future studies.

## MATERIAL AND METHODS

### Material

In this study, we use various artificial learning algorithms to classify the injury status of athletes. When choosing the algorithms we use, we consider the explainability of the results and the prediction accuracy. For this reason, we divide the algorithms we use into two categories: glass-box and black-box models. Here, glass-box models represent self-explanatory methods, while black-box models represent methods that cannot be self-explained and require complex and post-hoc explanations.

Glass-box methods are relatively more uncomplicated, and the results can be explained spontaneously due to their structure. These methods also appear in the literature as Transparent models,



Intrinsic explainability, Ante-hoc approaches, and Inherently interpretable machine learning models (Retzlaff et al., 2024). Linear/logistic regression, Decision Trees (DT), K-Nearest Neighbors (kNN), Rule-Based Methods, General Additive Models, and Bayesian Models can be given as examples of these methods (Barredo Arrieta et al., 2020). In our study, we used Logistic Regression (LR), Naive Bayes (NB), DT, and Explainable Gradient Boosting (EGB) algorithms to classify the injury status of athletes.

LR is one of the most basic machine learning models that offers binomial outputs and uses methods for binary classification. LR also estimates the probability of the occurrence of outcomes. NB is one of the most preferred classification algorithms due to its simple structure. This method provides probabilistic classification based on Bayes' theorem (James et al., 2023a). Unlike other methods, DT offers a classification by generating rules. In DTs, nodes represent attributes, and branches represent rules. The leaves representing the nodes at the bottom of the tree show the classification results (James et al., 2023b). The explainable boosting machine classifier is a tree-based generalized additive model. This method is an interpretability algorithm designed to be comparable to black-box methods regarding prediction accuracy. It basically uses the gradient-boosting procedure but uses a meager learning rate and round-robin cycles around features to show the impact of one feature at a time on the result (Nori et al., 2019).

Black-box models are methods that cannot be explained independently due to their complex structure but provide possibly robust predictions. They are preferable methods when the explanation is relatively unimportant. However, in critical areas such as the health sector, it is also essential to determine the results' attributes so techniques that explain these methods are being developed. In our study, we use black-box methods Random Forest (RF), Gradient Boosting (GB), Stochastic Gradient Boosting (SGB), Multi-Layer Perceptron (MLP), and Support Vector Machine (SVM). To explain the results obtained from these methods, we prefer Local Interpretable Model-agnostic Explanations (LIME) and Shapley Additive Explanations (SHAP) methods, which are widely used in the literature.

RF consists of many DTs working together. This method allows consistent results by creating different decision trees that serve the same purpose. GB is an ensemble machine learning model that uses different models together. The method aims to increase the prediction accuracy by directing different models to minimize the loss function value towards improvement in each iteration. SGB uses the same structure as GB but creates random subsets to reduce solution time and increase randomness (James et al., 2023b). SVM creates hyper-planes that maximize the distance between different classes for classification (James et al., 2023c). MLP is one of the most basic Artificial Neural Network algorithms. Although the method has strengths in detecting complex relationships, its explainability is relatively weak (James et al., 2023d).

Since the black-box methods described above cannot be explained directly due to their complex structure, they need post-hoc explanations. For this reason, methods are being developed to explain black-box methods. LIME and SHAP are the most well-known and used of these methods in the literature. To explain complex models, LIME focuses on a smaller local area rather than focusing on the entire complex model and expresses this area with a simpler model. Therefore, LIME can only provide local explanations (Lundberg and Lee, 2017). SHAP is based on the Shapley value, also known from game theory. The value allows the distribution of the total gains in cooperative games. In SHAP, the Shapley value is calculated for each attribute, representing the effect of the relevant attribute on the prediction (Riberio et al., 2016).

We use different performance metrics to evaluate the performance of our models. Since our prediction outputs are binary (0-1), our study uses classification algorithms. For this reason, we use Accuracy, Precision, Recall, and F1-score values, which are widely used in the literature, to measure the performance of the algorithms. These values are calculated according to the confusion matrix. In the confusion matrix, correctly predicted and correct values are presented as True Positive (TP), while correctly predicted but misreported values are presented as False Positive (FP). Similarly, values that are mispredicted and are actually incorrect are presented as True Negative (TN). In contrast, values predicted incorrectly but actually correct are presented as False Negative (FN). The calculation methods of metrics depending on these values are presented in Table 1.

**Table 7.** Performance metrics used in the study

Performance Metric	Formulation
Accuracy	$\frac{TP + TN}{TP + TN + FP + FN}$
Precision	$\frac{TP}{TP + FP}$
Recall	$\frac{TP}{TP + FN}$
F1-Score	$2 \times \frac{Precision \times Recall}{Precision + Recall}$

## Methods

### *The Collection of the Data*

We choose the data set we use in our study to test the hypothesis of how accurately we can make predictions with limited features. Therefore, we use a publicly available dataset that only includes athletes' age, weight, height, past injuries, training intensity, and recovery time (Mrsimple, 2024). This dataset was synthetically prepared to address the growing concern regarding accurately predicting player health and injuries in competitive sports. The attributes included in the data set and their explanations are also presented in Table 2.

**Table 8.** Features of the data set and their explanations

Feature	Explanation
Player Age	Age of the player in years.
Player Weight	The player's weight is in kilograms, following a normal distribution with a mean of 75 and a standard deviation of 10.
Player Height	The player's height is in centimeters, following a normal distribution with a mean of 180 and a standard deviation of 10.
Previous Injuries	Binary indicator representing whether the player has had previous injuries. <i>Categories:</i> 1: true, 0: false
Training Intensity	A value between 0 and 1 represents the intensity of the player's training regimen.
Recovery Time	Number of days required for the player to recover from an injury ranges from 1 to 6 days.
Likelihood of Injury (Output)	Binary indicator representing the likelihood of the player experiencing an injury. <i>Categories:</i> 1: true, 0: false

Our data set contains 1000 rows and does not require any cleaning process as it is well organized. At the same time, we did not apply a balancing process since our output variable was distributed evenly (50% - 50%).

## APPLICATION AND RESULTS

As mentioned in the previous sections, we applied black-box (RF, GB, SGB, MLP, and SVM) and glass-box (LR, NB, DT, and EGB) methods on the injury prediction data set. We used LIME and SHAP methods to explain black-box methods. We implemented the algorithms using the Python programming language and existing libraries. While we used the interpretML library for LIME, SHAP, and EGB, we also used the sklearn library for other algorithms. We completed all of our work on Google Colab.

In the first stage of our application, after the data collection process, we process the data to bring it into the format for the algorithms. Then, we move on to the model-building phase. At this stage, we

perform hyper-parameter optimization using grid search to select the best parameters for all models. We apply explanatory algorithms for black-box methods after bringing the models to their best state. Here, we aim to see the effect of all attributes on the result. Finally, we report the performance metrics of the models we applied to choose the best model for the data set we used. We present the conceptual design of our methodology in Figure 2.

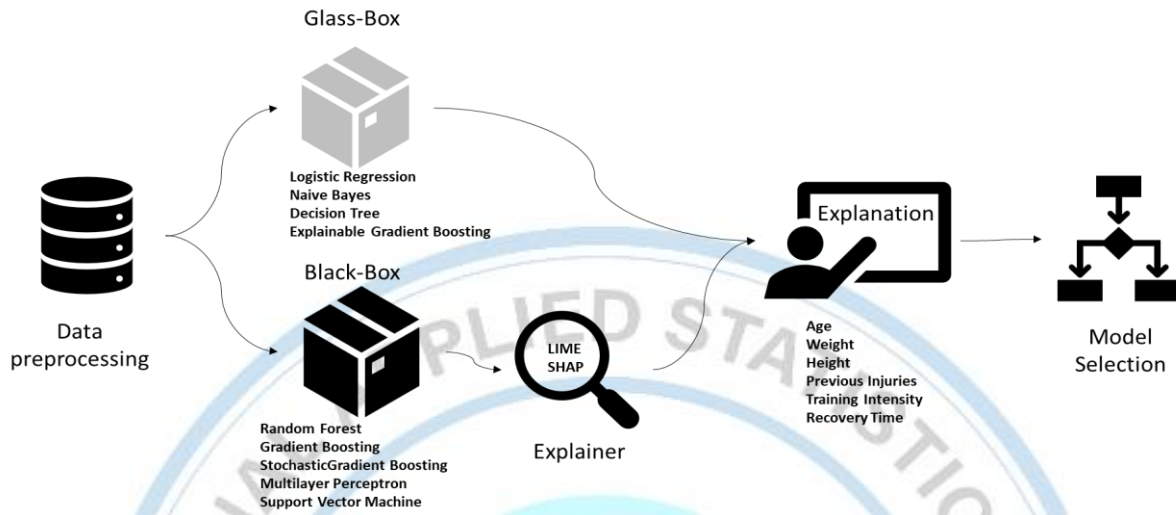


Figure 8. Conceptual design of the methodology used in the study

We present the parameters we obtained due to hyper-parameter optimization in Table 3. While the table presents the best parameters obtained for the models, we also report how long the hyper-parameter optimization took. We leave these fields blank for the models we use in their basic form in the table.

Table 9. Hyper-parameters of the models used in the study

Models	Hyper-Parameters	Best Model Parameters	Time (sec)
Logistic Regression	-		
Naïve Bayes	-		
Decision Tree Classifier	<ul style="list-style-type: none"> <li>• <i>Criterion</i>: Measure the split quality, which measures impurity.</li> <li>• <i>Splitter</i>: Define the strategy used to choose split at each node.</li> <li>• <i>Maximum Depth</i>: Give the tree's maximum depth.</li> <li>• <i>Maximum Features</i>: The number of features to consider when looking for the best split.</li> <li>• <i>Complexity Parameter</i>: Used for minimal cost-complexity pruning.</li> </ul>	<i>criterion</i> : gini <i>splitter</i> : random <i>max_depth</i> : 1 <i>max_features</i> : None <i>ccp_alpha</i> : 0	22.802
Random Forest Classifier	<ul style="list-style-type: none"> <li>• <i>Criterion</i>: Measure the split quality, which measures impurity.</li> <li>• <i>Number of Estimators</i>: The number of trees in the forest.</li> <li>• <i>Maximum Depth</i>: Give the tree's maximum depth.</li> <li>• <i>Weights associated with classes</i></li> </ul>	<i>criterion</i> : gini <i>n_estimators</i> : 200 <i>max_depth</i> : 4 <i>class_weight</i> : balanced	631.613
Support Vector Classifier	<ul style="list-style-type: none"> <li>• <i>Kernel</i>: The kernel type to be used in the algorithm</li> <li>• <i>Gamma</i>: Kernel coefficient:</li> <li>• <i>Regularization parameter</i></li> </ul>	<i>kernel</i> : sigmoid <i>gamma</i> : auto <i>C</i> : 4.5	10.884
Multi-Layer Perceptron Classifier	<ul style="list-style-type: none"> <li>• <i>Activation</i>: The hidden layer activation function</li> <li>• <i>Solver</i>: The solver for weight optimization</li> <li>• <i>Alpha</i>: Strength of the L2 regularization term</li> <li>• <i>Learning rate</i></li> <li>• <i>Maximum number of iterations</i></li> </ul>	<i>activation</i> : relu <i>solver</i> : lbfgs <i>alpha</i> : 0.02 <i>learning_rate</i> : constant <i>max_iter</i> : 200	4541.759



**Table 3.** continued

Gradient Boosting Classifier	<ul style="list-style-type: none"> <li>• <i>Loss</i>: Type of the loss function</li> <li>• <i>Learning Rate</i>: Learning rate shrinks the contribution of each tree</li> <li>• <i>Criterion</i>: Measure the split quality</li> <li>• <i>Maximum Depth</i>: Maximum depth of the individual regression estimators</li> <li>• <i>Max Features</i>: The number of features to consider when looking for the best split.</li> </ul>	<i>loss: log_loss</i> <i>learning_rate: 0.9</i> <i>criterion: friedman_mse</i> <i>max_depth: 3</i> <i>max_features: sqrt</i>	951.667
Stochastic Gradient Descent Classifier	<ul style="list-style-type: none"> <li>• <i>Loss</i>: Loss function type</li> <li>• <i>Penalty</i>: Regularization term</li> <li>• <i>Alpha</i>: Coefficient of the regularization term</li> <li>• <i>Learning Rate</i></li> </ul>	<i>loss: hinge</i> <i>penalty: l1</i> <i>alpha: 0.009</i> <i>learning_rate: optimal</i>	33.511
Explainable Boosting Classifier	-		

We get results by running our models on training and test data sets using the best model parameters. We allocate 80% of our data set for training and use 20% as a test data set. We present the performance metrics we calculated based on our results in Tables 4 and 5.

**Table 10.** Performance metrics of the models on the train data set

	#	Model	Performance Metrics (%)			
			Accuracy	Recall	Precision	F1-Score
Glass Box Models	1	Logistic Regression	55.75	55.75	55.7452	55.7476
	2	Naïve Bayes	54.375	54.375	54.394	54.3845
	3	Decision Tree	54.875	54.875	55.1415	55.0079
	4	Explainable Boosting	70.25	70.25	70.3626	70.3063
Black Box Models	1	Random Forest	72.125	72.125	72.2122	72.1686
	2	Support Vector	54.75	54.75	54.7449	54.7474
	3	Multi-Layer Perceptron	75.5	75.5	75.5007	75.5004
	4	Gradient Boosting	99.625	99.625	99.6253	99.6252
	5	Stochastic Gradient Descent	54.375	54.375	54.423	54.399

Looking at the results we obtained on the training data set presented in Table 4, we see that EGB produces the best results among glass-box models and GB among black-box models. Other models produced very poor results according to all performance metrics. However, to question whether these models are overfitting, we must examine their performance on the test data set.

**Table 11.** Performance metrics of the models on the test data set

	#	Model	Performance Metrics (%)			
			Accuracy	Recall	Precision	F1-Score
Glass Box Models	1	Logistic Regression	54	54	54.225	54.1123
	2	Naïve Bayes	59	59	59.2795	59.1394
	3	Decision Tree	51	51	51.5227	51.26
	4	Explainable Boosting	47	47	47.1934	47.0965
Black Box Models	1	Random Forest	50.5	50.5	50.7035	50.6016
	2	Support Vector	54	54	54.225	54.1123
	3	Multi-Layer Perceptron	48.5	48.5	48.4844	48.4922
	4	Gradient Boosting	48.5	48.5	48.4844	48.4922
	5	Stochastic Gradient Descent	50.5	50.5	50.5755	50.5377

When we examine the performance of the models on the test data set, we see that their performance is relatively low compared to the metrics we examined. Although NB provides better results than other glass-box methods, we do not find the choice appropriate considering its performance on the training data set. Although the performance of EGB on test data has decreased, considering its performance on training, EGB stands out among glass-box methods. In black-box methods, GB's performance decreased

dramatically. This situation shows that the model is overfitting. RF provided the other best performance on the training data sets. Although the performance of RF on the test data set decreases, it is at an acceptable rate compared to other models.

As we mentioned in the previous sections, although the prediction accuracy of the models is essential, their explainability is also very important. For this reason, we also examine the explainability performances of the models to find out which one should be chosen between the glass-box and black-box methods. For this purpose, we interpret the global and local explanations of the model by examining the weights given to the attributes by EGB, one of the glass-box methods. For RF, one of the black-box methods, we examine the explainability performances globally and locally using LIME and SHAP methods, respectively.

First, we present the global explanations in Figure 3 for EGB and Figure 4 for RF. Since LIME only provides local explanations, we obtain the global explanation for RF using SHAP. Accordingly, when we examine the figures, we see that the most impact on the prediction results comes from "past injuries," which is valid for both models. This attribute is followed by the "player's weight" and "recovery time." While the "player's age" affects the result more in EGB, this effect is less in RF.

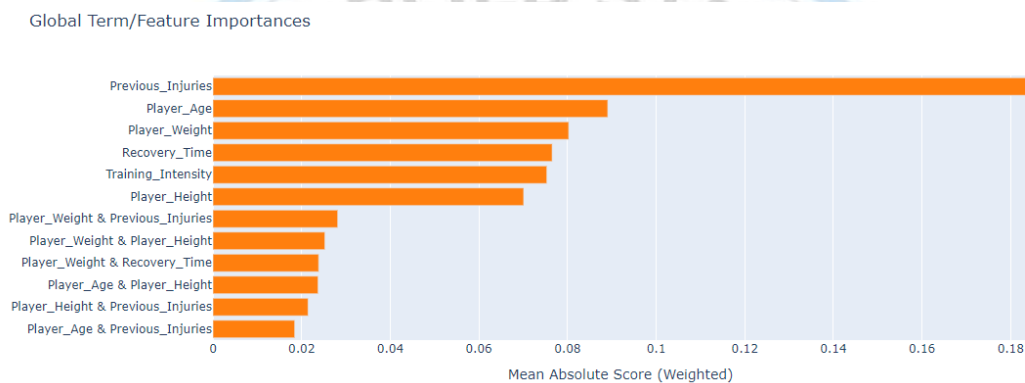


Figure 9. The global explanation for EGB

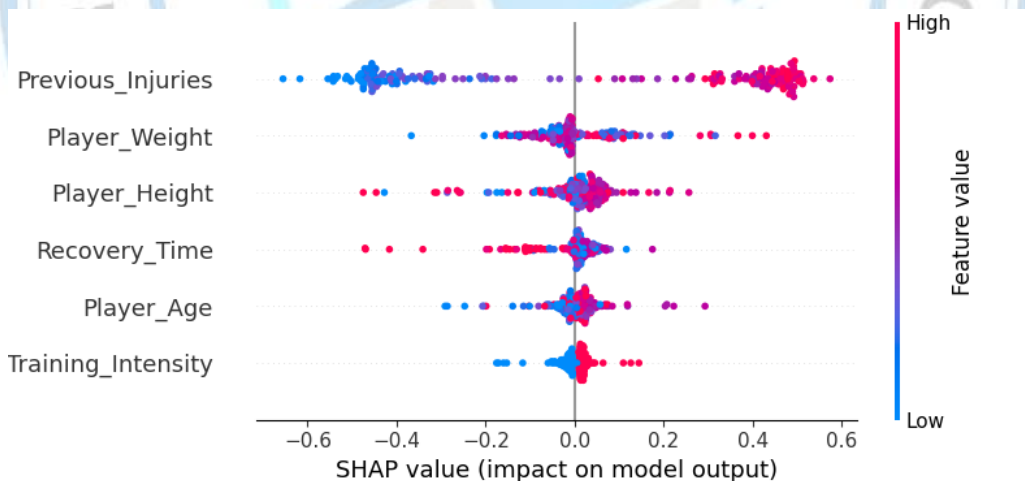


Figure 10. The global explanation for RF using SHAP

To examine the local explanation performance of the models, we examined the explanations obtained for a randomly selected individual from the data set. Both models correctly predicted the player's injury status for the selected instance. The attributes that affect this decision are "recovery time," "player's weight," and "training intensity" in EGB, which vary depending on the explanation method used for RF. While explanations similar to those of EGB are obtained with LIME, different explanations are offered with SHAP. This situation reveals that there may be inconsistencies in the explanations given to black-box methods.

Local Explanation (Actual Class: 0 | Predicted Class: 0  
 Pr(y = 0): 0.547)

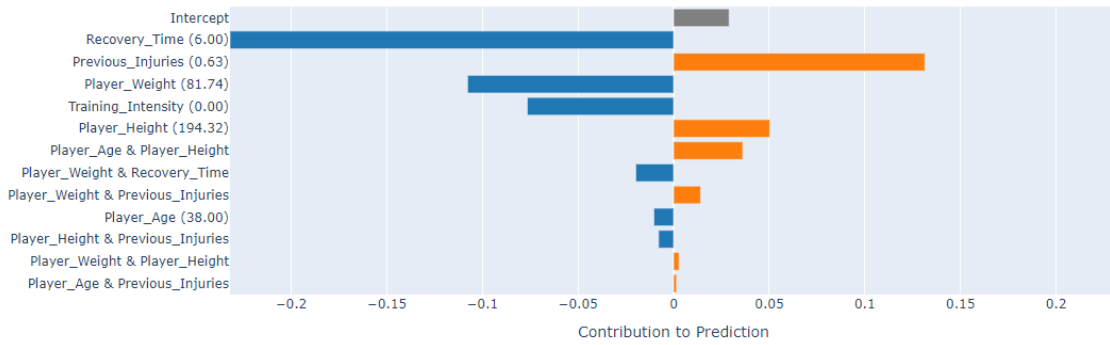


Figure 11. The local explanation for EGB

Actual: 0 | Predicted: 0.411

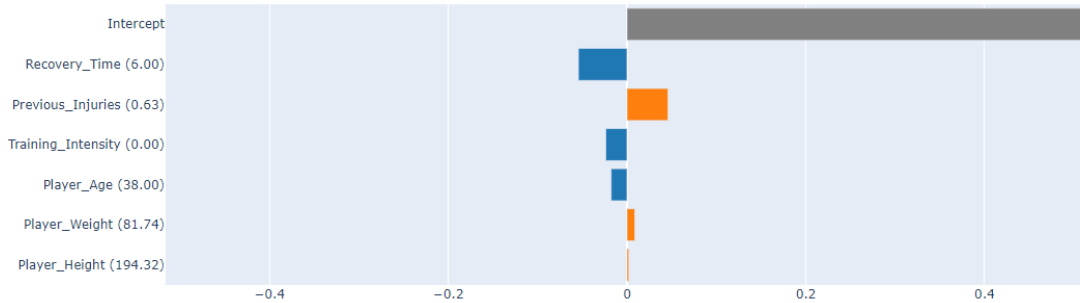


Figure 12. Local explanation for RF using LIME

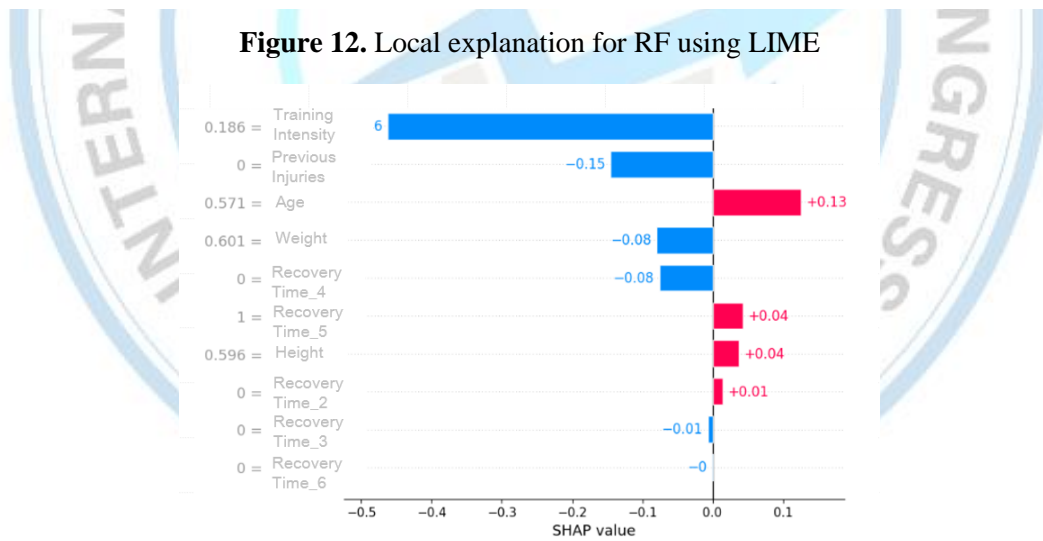


Figure 13. Local explanation for RF using SHAP

When we examined all the results obtained, we first saw that the attributes in the data set we used were insufficient to predict the athletes' injuries. In addition, we saw that EGB produces relatively better and more consistent results for predictions made using these features. However, thanks to the performance metrics and explanations presented, decision-makers can choose the appropriate model according to the situation they care about.

## DISCUSSION AND CONCLUSION

Predicting the injury status of athletes is essential for individual athletes to make career and training plans, as well as for club managers to carry out the correct transfer policy and manage resources



efficiently. Therefore, methods with high prediction accuracy should be used. However, it is also crucial that the predictions made are affected by which attributes and to what extent. This also requires examining the explainability performance of the methods used. Although different artificial learning algorithms have been used in the literature to predict the injury status of athletes, none of these studies have focused on the explainability of the methods used. In this study, we try various black-box and glass-box methods to predict the injury status of athletes on a publicly available data set. Glass-box methods are already explainable, but we use LIME and SHAP to explain the results obtained with black-box methods. By performing hyper-parameter optimization of all the algorithms we try, we optimize the algorithms for our data set. Then, we examine the prediction accuracy performances of the algorithms we use, as well as the local and global explanation performances they provide.

According to our results, RF, one of the black-box methods, and EGB, one of the glass-box methods, provide the most consistent results according to all performance metrics. However, when we examine the explainability performances, although similar results emerge in global explanations, LIME and SHAP, which are used for results obtained from RF in local explanations, report inconsistent results. In this case, we can comment that EGB is the method that best provides the balance between prediction accuracy and explainability. Although it is the most consistent among the methods we use, the overall performance of the algorithms on our data set is not sufficient. Therefore, in future studies, it is necessary to increase the number of features by adding information such as GPS data and blood values and try different algorithms to predict the injury status of athletes. Since the selection of the best algorithm will vary depending on the importance the decision maker attaches to prediction accuracy and explainability, the decision process may also vary in cases where the overall performance of the algorithms increases.

## References

- Andrade R, Wik EH, Rebelo-Marques A, Blanch P, Whiteley R, Espregueira-Mendes J, Gabbett T J, 2020. Is the acute: chronic workload ratio (ACWR) associated with the risk of time-loss injury in professional team sports? A systematic review of methodology, variables, and injury risk in practical situations. *Sports medicine*, 50, 1613-1635.
- Dandrieux PE, Navarro L, Blanco D, Ruffault A, Ley C, Bruneau A, Chapon J, Hollander K, Edouard P, 2023. Relationship between a daily injury risk estimation feedback (I-REF) based on machine learning techniques and actual injury risk in athletics (track and field): protocol for a prospective cohort study over an athletics season. *BMJ open*, 13(5), e069423.
- Du J, Mamo YZ, Floyd C, Karthikeyan N, James JD, 2023a. Machine learning in sport social media research: practical uses and opportunities. *International Journal of Sport Communication*, 1(aop), 1-10.
- Du J, Pifer ND, Gulavani SS, 2023b. Harnessing the Power of Machine Learning in Sport Consumer Behavior Research. In *Sports Sponsorship and Branding* (pp. 165-183). Routledge.
- Eliakim E, Morgulev E, Lidor R, Meckel Y, 2020. Estimation of injury costs: financial damage of English Premier League teams' underachievement due to injuries. *BMJ Open Sport & Exercise Medicine*, 6(1), e000675.
- Hudson D, Den Hartigh RJ, Meerhoff LRA, Atzmueller M, 2023. Explainable Multi-Modal and Local Approaches to Modelling Injuries in Sports Data. *IEEE International Conference on Data Mining Workshops (ICDMW)*, 4 December 2023, Page: 949-957, Shanghai, China.
- James G, Witten D, Hastie T, Tibshirani R, Taylor J, 2023a. Classification. In: *An Introduction to Statistical Learning*. Springer Texts in Statistics. Springer, Cham. [https://doi.org/10.1007/978-3-031-38747-0\\_4](https://doi.org/10.1007/978-3-031-38747-0_4)
- James G, Witten D, Hastie T, Tibshirani R, Taylor J, 2023b. Tree-Based Methods. In: *An Introduction to Statistical Learning*. Springer Texts in Statistics. Springer, Cham. [https://doi.org/10.1007/978-3-031-38747-0\\_4](https://doi.org/10.1007/978-3-031-38747-0_4)
- James G, Witten D, Hastie T, Tibshirani R, Taylor J, 2023c. Support Vector Machines. In: *An Introduction to Statistical Learning*. Springer Texts in Statistics. Springer, Cham. [https://doi.org/10.1007/978-3-031-38747-0\\_4](https://doi.org/10.1007/978-3-031-38747-0_4)
- James G, Witten D, Hastie T, Tibshirani R, Taylor J, 2023d. Deep Learning. In: *An Introduction to Statistical Learning*. Springer Texts in Statistics. Springer, Cham. [https://doi.org/10.1007/978-3-031-38747-0\\_4](https://doi.org/10.1007/978-3-031-38747-0_4)
- Lundberg SM, Lee S-I, 2017. A unified approach to interpreting model predictions. *Advances in Neural*

- Information Processing Systems, 30, 2017.
- Majumdar A, Bakirov R, Hodges D, Scott S, Rees T, 2022. Machine learning for understanding and predicting injuries in football. *Sports Medicine-Open*, 8(1), 73.
- Maupin D, Schram B, Canetti E, Orr R, 2020. The relationship between acute: chronic workload ratios and injury risk in sports: a systematic review. *Open access journal of sports medicine*, 51-75.
- MrSimple07. (2024). Injury prediction dataset [Data set]. Kaggle. <https://doi.org/10.34740/KAGGLE/DSV/7691337>
- Nori H, Jenkins S, Koch P, Caruana R, 2019. InterpretML: A Unified Framework for Machine Learning Interpretability. Access address: <https://interpret.ml/>; Date of access: 19.05.2024.
- Pu C, Zhou J, Sun J, Zhang J, 2023. Football player injury full-cycle management and monitoring system based on blockchain and machine learning algorithm. *International Journal of Computational Intelligence Systems*, 16(1), 41.
- Ribeiro MT, Singh S, Guestrin C, 2016. ‘Why should i trust you?’ Explaining the predictions of any classifier. in *Proceedings of the 22nd ACM SIGKDD international conference on knowledge discovery and data mining*, pp. 1135–1144.
- Rodrigues F, Pinto Â, 2022. Prediction of football match results with Machine Learning. *Procedia Computer Science*, 204, 463-470.
- Salian A, Ghosh B, Shetye H, Kapadia P, Srivastava K, 2024. Real-Time Injury Risk Assessment in Athletes Based on Relative Joint Angles. *International Conference on Emerging Smart Computing and Informatics (ESCI)*, 5-7 March 2024, Page: 1-6, Pune, India.
- Theadom A, Mahon S, Hume P, Starkey N, Barker-Collo S, Jones K, Majdam M, Feigin VL, 2020. Incidence of sports-related traumatic brain injury of all severities: a systematic review. *Neuroepidemiology*, 54(2), 192-199.
- Van Eetvelde H, Mendonça LD, Ley C, Seil R, Tischer T, 2021. Machine learning methods in sport injury prediction and prevention: a systematic review. *Journal of experimental orthopaedics*, 8, 1-15.

#### **Conflict of Interest**

The authors have declared that there is no conflict of interest.

#### **Author Contributions**

**Eyüp Ensar Işık:** Proposition of the study, Conceptualization, Methodology, Software, Validation, Data curation, Writing -original draft. **Gülşah Şahin:** Conceptualization, Literature review, Writing -original draft. **Mehmet Soydan:** Literature review, Writing -original draft.



## Increasing Production Planning and Control Efficiency by Using Machine Learning Methods in Standard Time Calculation

**Halil Erkan Akdoğan<sup>1\*</sup>, Burcu Yılmaz Kaya<sup>2</sup>**

<sup>1</sup>Gazi University, Institute of Science, Industrial Engineering, 06500, Ankara, Türkiye

<sup>2</sup>Gazi University, Engineering Faculty, Industrial Engineering Department, 06570, Ankara, Türkiye

\*Corresponding author e-mail: 22830701815@gazi.edu.tr

### *Abstract*

*Production planning is a critical process to increase the efficiency of businesses, reduce costs and meet customer demands on time. As in almost all processes in organizations, the basis of this process is standard time calculations that determine how long production activities will take. Thanks to the correct determination of standard times, production capacities of enterprises can be estimated accurately, resource allocations can be optimized and delivery times can be planned rationally. Under today's competitive conditions, production planning in sectors such as aerospace and defense industry becomes a more important and critical process to increase efficiency levels and reduce costs. Due to the complexity and dynamic nature of production processes, traditional standard time calculation methods could unfortunately cause decision makers and managers to face various limitations in practice. Particularly in batch jobs, varying order quantities, un-similar product structures, seasonal orders, products which demands high manual labor, and jobs with long processes to measure workflows, determining the standard time with direct or indirect traditional methods is labor-intensive and investment-intensive, and even the decision indicates to endure it, yet it is often not possible to make accurate calculations and measure the exact times. In this context, instead of calculating the standard time by using traditional tools such as time study, work sampling or predetermined motion and time systems in work measurement studies, the use of machine learning methods is gaining popularity today thanks to the advances in technology, computational capacity and data science researches. Machine learning (ML) algorithms are the general name of computing algorithms that model the solution space according to the given input problem data via the specified rules and self-generated inference information. ML tools are systems that are developed and trained from real data to make clustering, classification and predictions using statistical methods. The calculation model created with large data sets and a specially determined algorithm suitable for the problem structure and purpose is established to give the highest performance in outputs in terms of consistency, reliability, error percentages and suitability levels of the results. In this study, a problem regarding the precise estimation of the standard time for improvement in the production planning activities of a large-scale company operating in the defense industry is addressed. In the real-life problem examined, standard time calculation in work measurement operation is performed by the employment of ML for parts with both short and long-term production flows, especially in product families that are produced with intensive manual labor and have high variability due to product design and part geometry. Problem definition, data collection, model training, tests and validation processes are explained consecutively, and the performance of the ML model in the proposed solution approach in standard time estimation is calculated and presented. The results are explained in details, supported by graphical representations and numerical representation of the outputs, and are also discussed in the light of the potential advantages and limitations of ML methods in standard time calculation and work measurement activities, based on real-life application.*

**Keywords:** Standard Time, Production Planning, Process Management, Artificial Intelligence, Machine Learning.

### **INTRODUCTION**

Production planning and control processes are critical elements that directly affect the overall performance of enterprises. Standard time calculations, which occupy a central place in these processes, are indispensable for labour management, production volume determination and cost control. However, existing traditional methods are inadequate in the face of the increasing complexity and variability of

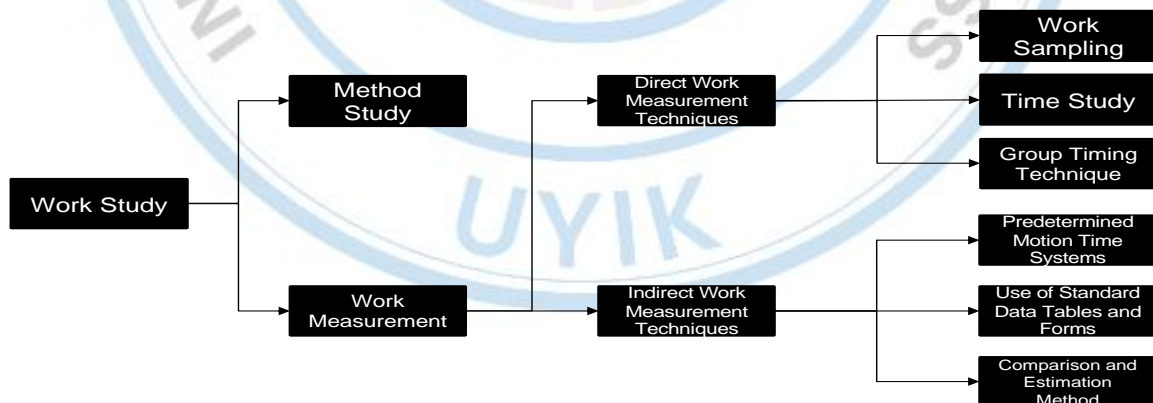


production processes, and this is especially evident in sectors with variable product designs and complex part geometry. In areas with manual labour intensive and constantly changing product structures, such as the defence industry, accurate calculation of standard times is becoming increasingly difficult. Erroneous calculations made by traditional methods or time constraints lead to incorrect production planning and resource allocations, increasing the costs of enterprises, reducing operational efficiency and negatively affecting customer satisfaction. These problems reduce the competitiveness of enterprises and weaken their market position.

The main objective of this study is to perform standard time calculations more accurately and efficiently using machine learning (ML) technologies. Advanced ML models, such as artificial neural networks (ANNs), can quickly adapt to changing production conditions and different product structures thanks to their data-driven learning capabilities (Eraslan, 2009; Dağdeviren et al., 2011). This adaptation increases the accuracy of standard time estimates, allowing businesses to more accurately estimate their production capacity, use their resources more effectively and meet customer demands more successfully. Especially in sectors with complex and variable production processes, this technological approach strengthens the competitive advantages of enterprises by providing significant time and cost savings. This study examines how ML methods can transform production planning and control processes and improve the accuracy of standard time estimates.

Standard time is obtained by work measurement. Work measurement (WM) is the evaluation of the time required to complete a job using the several techniques. It enables the organization to promote productivity and measure direct time study (Yuliani et al., 2019).

WM refers to studies that include various time measurements and statistical analyses in order to measure and monitor productivity in production, where, the techniques to be used in this process could be analysed under two main headings as direct and indirect WM techniques, as it was presented with Figure 1, hereinafter (Kurt and Dağdeviren, 2020). The most well-known and frequently employed direct WM technique, time study (TS) records the process time and levels of a predetermined work using specified conditions. The collected data is analyzed and used to identify the time required to finish the work with a defined process speed. Unfortunately, TS is cost ineffective and can be applied only under some specific conditions (Dağdeviren et al., 2011).



**Figure 1.** Work study technics

Direct WM techniques have generally been analysed under three categories, i.e. TS, work sampling, and group time studies (GTS) technique (Kurt and Dağdeviren, 2020).

As another direct WM technique, work sampling is a method of determining the occurrence rate (in %) of a certain activity through statistical sampling and random observations. It is commonly used to determine the performance (such as work rate) of a system or system element (worker or machine)

(Güner et al., 2016), in other words, to determine the rate of occurrence of a specific type of flow to be analysed within a certain flow.

GTS is used in operations where a large number of workers perform a large number of operations jointly. Group timing technique is a method of WM which enables an observer with a stopwatch to observe 2-15 workers or machines at a time and obtain detailed results (Pamir, 1984; Tiefenthal, 1963). It is based on the principle of continuous observation of work elements at predetermined fixed intervals and grading the performance of workers. In this sense, GTS is very similar to work sampling, but it is not based on a random basis. The length of time between observations is developed depending on the number of workers and machines and their locations. However, the time interval is required to have a shorter time value than the shortest work element (Pamir, 1984). This technique is mostly preferred in maintenance-repair and clerical works. It is stated that the method is advantageous in controlling standards and determining the amount of workload because it is easy and inexpensive, also, it does not require a well-trained observer (Çelikoğlu, 1989).

When production or work planning is carried out, the duration of the process must be determined. The accuracy and reliability of these times are very important for businesses. The problems encountered in determining the standard time brings the need for alternative work measurement methods in addition to the direct measurement techniques (Dağdeviren et al., 2011).

### **Indirect Work Measurement Techniques**

Indirect WM techniques were classified generally under three main headings as methods of comparison and prediction method (CPM), standard data and formulation (SDF) and pre-determined motion-time systems (PMTS) (Niegel and Freivalds, 2003; Dağdeviren et al., 2011; Kurt and Dağdeviren, 2020). It is obvious that indirect WM cannot be used in all companies to measure the standard time for every kind of system designs (Dağdeviren et al., 2011), however, in cases where the direct studies could not be managed due to several reasons such as long production cycles, discontinuous orders, new processes, new product designs, etc. these WM techniques become very handy to compute the standard time of the products or semi-products.

Standard data and formulation method (SDF) is based on the formulation that the work time is calculated using the previously completed time studies and assume that the factors affecting the time are declared as variables. Regression analysis is one of these methods. The most significant disadvantages of this method are the impossibility of deriving a formulation expressing the behavior of all systems and the condition of ineffectiveness of a mathematical function that effect time (Çakit and Dağdeviren, 2023).

PMTS, also known as Synthetic Time Systems, is a procedure that analyses any manual operation, determines the basic movements required, and calculates a predetermined standard time for each basic movement according to the factors affecting it. PMTS shift the focus of the standard time calculation from the work measurement to the method, and in the calculations, predetermined basic methods with known time measures are used as measures for working times. Another benefit of this technique is that they are universal, with the common coding of motion elements, the work process was recognised on an international scale (Garg and Saxena, 1985; Groover, 2007; Kurt and Dagdeviren, 2020; Çakit and Dağdeviren, 2023).

## **MATERIAL AND METHODS**

### **Machine Learning**

The main purpose of ML is to reach a meaningful result and produce a product by utilising the incoming data and for this, it needs three basic components listed as data, variables (parameters) and algorithm

(Siddiqui and Abdullah, 2015)

ML is a branch of artificial intelligence that includes several learning paradigms such as supervised learning, unsupervised learning and reinforcement learning (Shirzadi et al., 2018). Artificial intelligence has become a branch of engineering that creates intelligent machines, especially intelligent computing mechanisms. The main expectation is to develop algorithms that bring the characteristics of human intelligence to the computer and to develop systems that can produce solutions to problems by exhibiting intelligent behaviours like humans. Artificial intelligence is a branch of science that can learn from experience, reason what it has learnt, recognise shapes, images and patterns, produce solutions to complex problems, understand language and perform operations with words, and bring a different perspective to the world of informatics (Öztemel, 2020). With the increasing growth of data in many sectors, the adoption of appropriate ML algorithms can improve the efficiency of data analysis and processing, as well as solve some practical problems (Lou et al., 2021). ML has been covered in depth in many studies (Eraslan, 2009; Dağdeviren et al., 2011; Marsland, 2014; Mohri et al., 2018; Alpaydin, 2020; Çakıt and Dağdeviren, 2023).

#### *Supervised Learning*

Supervised learning is one of the most basic and widely used approach of ML (Bonaccorso, 2017). In this method, a model aims to learn the relationship between input and output in the training data and use a test data set to make effective predictions about the set with unknown results based on the classification made from the set with known results. Hence, the more accurate the data given for training, the more accurate the predictions be (Okur, 2020).

Typically, the data set for supervised learning methods is divided into two as training data and testing data sets. Training data is the data consisting of observations considered for the algorithm to be used. Using these data, inferences are made with the algorithm and a model is created. Test data are the data used to determine how close the model obtained with the training data is to the real values, in other words, how successful the system is (Canpolat, 2022). The training data set consists of labelled data samples, i.e. the correct output corresponding to each input is known. Supervised learning algorithms build a model using the training data set and make predictions for new inputs (Bishop, 2006; Aydın and Özkul, 2015). Supervised ML primarily focuses on prediction and estimation problems (Kaya, 2015). The aim of this approach is to determine which output value corresponds to the labelled data that belongs to which class. The difference between the model created and the result obtained expresses the error rate. This rate is always tried to be minimised (Kavuncu, 2018).

#### *Unsupervised Learning*

Unsupervised learning is an ML approach used to discover patterns and structures in the data set (Hastie et al., 2009). In this method, the output labels in the data set are not present and the algorithm performs structural analyses on the data, separating data points into groups or simplifying the data by methods such as dimension reduction (Bishop, 2006). Unsupervised ML, also called density estimation, is a type of learning that determines a suitable representation for the input data, which is used to group data with similar characteristics to the data with no class. Since this type of learning consists only of input values, there is no output (class or label) value corresponding to the inputs. Therefore, it is not known to which class the inputs belong (Fatima and Pasha, 2017).

#### *Semi-Supervised Learning*

This type of ML provides a technique that harnesses the power of both supervised learning and unsupervised learning. In the previous two types, either output labels are provided for all observations or no labels are provided at all. There may be cases where some observations are provided with labels, but the majority of observations are not labelled due to the high cost of labelling and lack of skilled human expertise. In such cases, semi-supervised learning is best suited for model building. Semi-supervised learning can also be used in problems such as classification, regression and prediction (Alzubi et al., 2018).

#### *Reinforcement Learning*

This ML approach has supervision as in supervised learning. However, differently, while the supervisor



defines the inputs, the outputs were produced by the machine. The supervisor sends signals indicating the correctness or incorrectness of the outputs. The machine continues to learn by taking into account the incoming signal (Rizvanche, 2020). Reinforcement learning is an area of ML concerned with how software agents should act in an environment to maximise the concept of cumulative reward (Mahesh, 2018).

### Deep Learning

Deep learning allows a machine to be fed with large amounts of raw data and to discover relationships. It can therefore be used to process more complex data. Deep learning is based on neural networks with multiple layers. Deep learning can be supervised or unsupervised. Deep learning has been one of the main areas of recent developments in ML with the increase in computer processing power (Panch et al., 2018). Deep learning is a ML concept based on ANNs. For many applications, deep learning models outperform shallow ML models and traditional data analysis approaches (Janiesch et al., 2021).

### Artificial Neural Network Method

ANNs are one of the supervised learning algorithms modelled on biological neural networks that work in a similar way to the nervous system of the human brain. The aim of this algorithm is to automatically realise these abilities, which are unique to human beings, such as decision-making, interpretation, relationship building, discovering and producing new information, which occur in the human brain through learning, without assistance. ANNs consist of different combinations of nerve cells with each other. They are often organised in layers and can be designed together with electronic circuits (Çam, 2021). ANNs are widely used in many fields such as natural language processing, audio processing, image processing, medicine and communication (Kavuncu, 2018).

ANNs learn by gaining experience from realised events. For this reason, it does not have the problem of collecting information as in mathematical systems, it makes use of examples. The examples it uses must accurately represent the situations that the system is intended to learn. The performance of the network depends on how the problem was represented. ANNs are defined as a black box in which multiple simple processing elements produce outputs from inputs. These simple cells have a hierarchical structure (Rizvanche, 2020). Besides, its structure affects the learning system and rules of the network. The processor elements in the network are in constant communication. The layers that make up ANNs are the input layer, hidden layer and output layer (Rizvanche, 2020) and a general structure of an ANN model was presented in Figure 2 (Bre et al., 2017), hereinafter.

The input layer ( $i$ ) contains at least one input data, while, no processing is applied to the data in this layer. The hidden layers ( $h$ ) process the data where the data coming from the input layer are subjected to certain processes. The structure of the hidden layer depends on the structure of the ANN and may vary, as well as, it may contain one layer or multiple layers. The output layer ( $o$ ) contains at least one output. The output is determined by the function contained in the network. Various operations were performed here and the outputs were transferred to the outside world (Rizvanche, 2020).

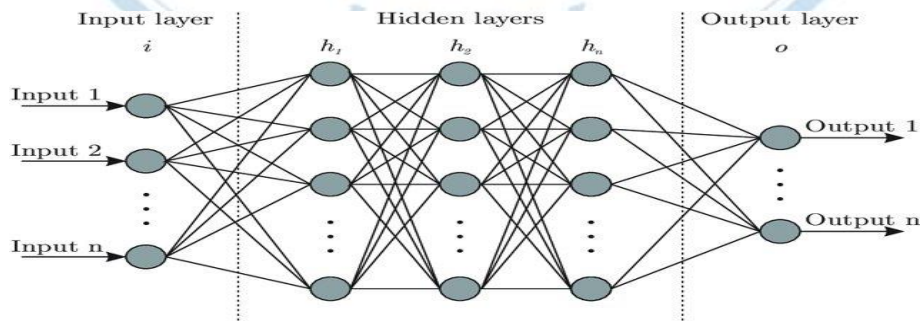


Figure 2. ANN structure

Inputs are information sent to the nuclei of artificial neurons. This situation is similar to information transportation from dendrites to the cell nucleus in biological nerve cells. The information can come from outside the network or from another artificial neuron (Öztemel, 2006).

The information sent to artificial neurons is multiplied by the weight of the connections they are sent

to before reaching the neuron nucleus through the inputs and transmitted to the neuron nucleus. This is done in order to adjust the effect on the outputs to be produced from the inputs. Weights can take positive, negative or zero values (Çayıroğlu, 2019).

The summation function refers to the function that calculates the net input to the neuron nucleus by adding the inputs sent to the artificial neurons multiplied by the weights. Addition functions are of different types and there is no method developed to determine these functions. In other words, addition functions were determined by trial and error. Activation functions are the functions that determine the output of the cell by processing the net inputs calculated in artificial neurons. The problem of determining the summation function is also the same for activation problems. There are different types of activation functions and the decision of which one to use is left to who designs the network (Konuk, 2023).

## APPLICATION

### Problem Definition

The study was carried out in a composite product manufacturing company operating in the aviation, space and defence industry. The company has approximately 900 types of products in its product range and manufactures approximately 18000 products annually with 250 personnel. In addition to this, in order to support the R&D processes of Turkey's leading defence industries, it increases its product range by producing new types of products received from customers every year and manufactures for the aviation and defence industries in Turkey and abroad.

The production process analysed within the scope of the study requires long measurement time due to its complexity, dependence on manpower and high variety of parts. For this reason, direct work measurement techniques cannot be applied and exact standard times cannot be determined, productivity measurements do not give accurate results, and the success rates of production planning activities are low.

The production process starts with the preparation of moulds in the mould shop and continues with ply-cut, lay-up, autoclave, trimming, painting and assembly processes. The lay-up process, which is discussed in our study, constitutes 70% of the entire production process. Accurate determination of standard times is important in order to accurately estimate production capacities, optimise resource allocations and rationally plan delivery times. However, traditional standard time calculation methods may cause decision makers and managers to face various limitations in practice due to the complexity and dynamic nature of production processes. Especially in the case of batch jobs, varying order quantities and product structures, products with high manual workmanship, and jobs with a long workflow, determining the standard time with direct or indirect traditional methods requires intensive labour and investment, and yet it is often not possible to make accurate calculations. In this context, instead of calculating the standard time with the use of traditional direct WM techniques such as TS, work sampling or indirect WM techniques such as PMTS, CPM technique was practiced to calculate standard times and ANN algorithm was used in the handled real world WM study.

### Problem Data

Within the scope of the study, 443 parts were examined and 26 types of properties of the relevant parts were evaluated. These features were the design geometry of the product, the number of floors in which 12 types of materials are used in the produced parts, the amount of use on the floors where 12 types of materials are used, and the number of vacuums operations. Due to the abundance of input data, not all data can be tabulated, but some of the input data are presented in Figure 3, hereinafter, in order to better understand the problem for the reader and to make the problem structure traceable.





**Table 1.** Performance Criteria Results Summary

Performance Criteria	Result
MAE	0.4886 hours
MSE	0.4727 hours <sup>2</sup>
RMSE	0.6875 hours
R <sup>2</sup>	0.8933

The predictions deviated from the actual values by 0.4886 hours on average according to the yielded MAE values (Table 1). This can generally be considered a low amount of error. According to the MSE metric (the mean of the squares of the errors) a value of 0.4727 hours<sup>2</sup> (Table 1) indicates that the model may make some large errors, but this value is still relatively low. This indicates that the model performs well for most predictions, but in some special cases the errors may be larger. To analyse the severity of the errors in original units, RMSE metric was used. In this case, it indicates that the model's predictions deviate from the actual values by 0.6875 hours on average (Table 1). This value could be considered as a generally acceptable level in terms of the magnitude of the errors. The R<sup>2</sup> value was found to be 0.8933 (Table 1). It is quite high and indicates that the model can successfully explain a large proportion of the variance in the data set, which means that the model is generally modelling the data well and the predictions are reliable.

## DISCUSSION AND CONCLUSION

Although it is not always easy to determine the standard times, which are the basic input of production planning studies, with traditional methods, in the company where the study was carried out; customers frequently transfer new parts in bulk. In order to make production planning accurately, it is critical that these parts, which are not known at all and whose technical specifications are only known, are transferred to the customer at the correct dispatch times. ANN methodology was used to determine the standard times of these parts that have not yet been experienced in production.

Within the framework of the study, 443 parts whose standard times were determined by traditional methods were evaluated with 26 parameters and compared with the results obtained from the model. As a result of the comparison, satisfactory results, especially in MAE and R<sup>2</sup> values, showed that the established algorithm produces reliable values.

It is seen that the method is economically feasible in many companies. According to the managers of the selected manufacturing company, by using these factors in the forecasting process, the standard times of the whole product or semi-product can be estimated in a short time. In addition, the company will save considerable time and cost in the planning of production and management activities in future periods.

## References

- Alzubi, J., Nayyar, A. and Kumar, A., 2018. Machine Learning from Theory to Algorithms: An Overview. *Journal of Physics: Conference Series*, 11 (42): 1-15.
- Aydın, S. ve Özkul, A. E., 2015. Veri Madenciliği ve Anadolu Üniversitesi Açıköğretim Sisteminde Bir Uygulama. *Eğitim ve Öğretim Araştırmaları Dergisi*, 4 (3): 38.
- Bre, F., Gimenez, J. M., & Fachinotti, V. D., 2017. Prediction of Wind Pressure Coefficients on Building Surfaces Using Artificial Neural Networks. *Energy and Buildings*, 158: 1424-1434. doi:10.1016/j.enbuild.2017.11.045
- Çakıt E. and Dağdeviren M. 2023. Comparative Analysis of Machine Learning Algorithms for Predicting Standard Time in A Manufacturing Environment. *Artificial Intelligence for Engineering Design, Analysis and Manufacturing*, 37, e2: 1–12.
- Dağdeviren, M., Eraslan, E. and Çelebi, F. V., 2011. An Alternative Work Measurement Method and Its Application to A Manufacturing Industry. *Journal of Loss Prevention in the Process Industries*, 24 (5): 563-567.
- Eraslan, E., 2009. The Estimation of Product Standard Time by Artificial Neural Networks in the Molding Industry. *Mathematical Problems in Engineering*, 2009: 1-12.
- Fatima, M. and Pasha, M., 2017. Survey of Machine Learning Algorithms for Disease Diagnostic.

- Journal of intelligent Learning Systems and Applications, 9: 1-16.
- Garg, A. and Saxena U. 1985. Physiological Stresses in Warehouse Operations with Special Reference to Lifting Technique and Gender: A Case Study, American Industrial Hygiene Association Journal, 46:2, 53-59.
- Güner, M., Küçük, M. ve Acar, E., 2016. Üniversite Öğrencilerinin Ders Esnasındaki Davranışlarının İş Örnekleme Yöntemiyle Değerlendirilmesi. Düzce Üniversitesi Bilim ve Teknoloji Dergisi, 15-22.
- Janiesch, C., Zschech, P. and Heinrich, K., 2021. Machine Learning and Deep Learning. Electronic Markets, 31: 685-695.
- Lou, R., Lv, Z., Dang, S., Su, T. and Li, X., 2021. Application of machine learning in ocean data. Multimedia Systems, 2021: 1-10
- Panch, T., Szolovits, P. and Atun, R., 2018. Artificial Intelligence Machine Learning and Health Systems. Journal of Global Health, 8 (2): 1-8.
- Shirzadi A, Soliamani K, Habibnejhad M, Kavian A, Chapi K, Shahabi H, Chen W, Khosravi K, Thai Pam B, Pradhan B, Ahmad A, Bin Ahmad B and Tien Bui D (2018) Novel GIS based machine learning algorithms for shallow landslide susceptibility mapping. Sensors 18, 3777.
- Siddiqui, T. A. and Abdullah, Y., 2015. Developing a Nonlinear Model to Predict Stock Prices In India: An Artificial Neural Networks Approach. IUP Journal of Applied Finance, 21 (3): 36.
- Yuliani, E. N. S., Kholil, M., Setianingrum, A. Y. And Wardoyo, A. S. 2019. Development of Direct Time Study Technology for Advanced Work Measurement. Internetworking Indonesia, 11 (2): 51-56.
- Alpaydin, E., 2020. Introduction to Machine Learning. MIT Press, Cambridge.
- Bishop, C. M., 2006. Pattern Recognition and Machine Learning (Information Science and Statistics). Springer.
- Bonaccorso, G., 2017. Machine Learning Algorithms. Packt Publishing Ltd.
- Groover, M. P., 2007. Work Systems: The Methods, Measurement and Management of Work (1st ed.). Pearson New International Edition.
- Hastie, T., Tibshirani, R. and Friedman, J., 2009. The Elements of Statistical Learning – Data Mining Inference and Prediction. Springer.
- Kurt, M. and Dağdeviren, M., 2020. İş Etüdü. Dünya Tıp Kitabevi, Ankara.
- Marsland, S., 2014. Machine Learning: An Algorithmic Perspective. CRC Press, Boca Raton.
- Mohri, M., Rostamizadeh, A. and Talwalkar, A., 2018. Foundations of Machine Learning. MIT Press, Cambridge.
- Niebel, B. and Freivalds, A. 2003. Methods, Standards and Work Design (11th ed.). USA: McGraw-Hill
- Öztemel, E., 2006. Yapay Sinir Ağları. Papatya Yayıncılık, İstanbul.
- Öztemel, E., 2020. Yapay Zekâ ve İnsanlığın Geleceği. Marmara Üniversitesi.
- Pamir, T. C., 1984. İş Etüdü. SEGEM Yayınları, Ankara.
- Tiefenthal, R., 1963. Group Timing Technique Industrial Engineering Handbook. Maynard H.B. (Ed.), 3rd Edition. McGraw-Hill Book Company Inc. pp.3.70-3.91, New York.
- Canpolat, H. N., 2022. Analysis of the Preference of Covid-19 in Statistical Regions of Turkey by Machine Learning Methods. M. Sc. Thesis, Gazi University Graduate School of Natural and Applied Sciences, Department of Industrial Engineering.
- Çam, K., 2021. Machine Learning Supported Decision Support System for Small and Medium Sized Companies. M. Sc. Thesis, Dokuz Eylül University, Graduate School of Social Sciences, Department of Management Information Systems.
- Çelikoğlu, C. C., 1989. An Approach to the Sufficiency Problem in Time Study. PhD Thesis, Anadolu University Graduate School of Natural and Applied Sciences, Department of Industrial Engineering.
- Kavuncu, S. K., 2018. Machine Learning and Deep Learning: Applications of Object Recognition. M. Sc. Thesis, Kırıkkale University Graduate School of Natural and Applied Sciences Department of Computer Engineering.
- Kaya, T., 2015. Web Based Software Capable of Risk Prediction for Traffic Accidents with Machine Learning Methods. M. Sc. Thesis, Gazi University Institute of Informatics, Department of Computer Education.
- Konuk, C., 2023. Pattern Recognition with Neural Networks in Statistical Quality Control Charts. M.

Sc. Thesis, Dokuz Eylül University Graduate School of Natural and Applied Sciences, Department of Statistics, Data Science Programme.

Okur, H., 2020. Credit Risk Prediction with Machine Learning Methods. M. Sc. Thesis, Gazi University Graduate School of Natural and Applied Sciences, Department of Computer Engineering.

Rizvanche, S., 2020. A Decision Support System Based on Machine Learning and Time Series for Demand Forecasting. M. Sc. Thesis, Eskişehir Technical University, Institute of Graduate Programs, Department of Industrial Engineering.

**Conflict of Interest**

The authors have declared that there is no conflict of interest.





Statistical Inference of Process Capability Index  $C_{pm}^*$  for the Chen Distribution with Application

Kadir Karakaya<sup>1\*</sup>

<sup>1</sup> Selçuk University, Faculty of Science, Department of Statistics, 42130, Konya, Türkiye

\*Corresponding author e-mail: kkarakaya@selcuk.edu.tr

Abstract

Quality control engineers use the process capability index to monitor the capability of a process. The process capability index indicates whether the products meet the required specifications. Classic indices like  $C_{pm}$  are commonly used when measurements follow the normal distribution. However, the distribution of measurements may not always follow a normal distribution, thus requiring alternative process capability indices. One alternative to the  $C_{pm}$  index is the  $C_{pm}^*$  index introduced by (Karakaya, 2024). The  $C_{pm}^*$  index is quantile-based, can be applied to both normal and non-normal measurements, and serves as a generalized form of the conventional  $C_{pm}$ . This study examines the  $C_{pm}^*$  index based on the Chen distribution. The maximum likelihood estimation of  $C_{pm}^*$  is studied, and interval estimation is conducted using the approximate confidence interval based on the Fisher Information principle. The performance of point and interval estimations is evaluated through Monte Carlo simulation. The usability of the  $C_{pm}^*$  in the field of engineering is also demonstrated using real data analysis.

**Keywords:** Chen Distribution, Maximum Likelihood Estimation, Process Capability Index, Ball-Size Data

INTRODUCTION

There are various procedures to evaluate a production process. Quality control charts are a crucial tool used to assess the stability and consistency of the process. The control charts examine the variation in a process to determine whether measurements meet pre-defined specifications. If the control chart results indicate that a process is unstable, it suggests that the variability is due to a specific cause. In quality control studies, quality engineers use specific capability indices to monitor the capability of the process. Process capability index (PCI) is also considered to determine whether the products meet the required specifications or customer demands. Several PCIs are introduced to assess the capability of the process. Some of these include  $C_p$ ,  $C_{pk}$ ,  $C_{pm}$ , and  $C_{pmk}$ . For more detailed information on these PCIs, refer to (Kane, 1986), (Chan and Cheng, 1988), and (Pearn et al., 1992). The first PCI is  $C_p$  introduced by (Juran 1987) and formulated as

$$C_p = \frac{U - L}{6\sigma},$$

where  $\sigma$  is the standard deviation of the process,  $L$  is the lower specification limit and  $U$  is the upper specification limit. The  $C_p$  has certain limitations; for example, it does not consider the process mean and doesn't indicate if the process is not centered at the target value. To address these drawbacks of  $C_p$ , several new PCIs have been proposed. One of the most commonly used is the  $C_{pm}$  index. The  $C_{pm}$  index was introduced by (Hsiang and Taguchi, 1982) and later modified by (Chan and Cheng, 1988). The  $C_{pm}$  was defined as

$$C_{pm} = \frac{U - L}{6\sqrt{\sigma^2 + (\mu - T)^2}}, \tag{1}$$

where  $\mu$  is the mean of the process and  $T$  is the target value. When  $\mu = T$ , the  $C_{pm}$  is reduced to  $C_p$ . An

alternative process capability index demonstrated as  $C_{pm}^*$  was proposed by (Karakaya, 2024). The  $C_{pm}^*$  index is quantile-based, can be used for both normal and non-normal measurements, and represents a generalization of the conventional  $C_{pm}^*$  index and  $C'_{pm}$  index introduced by (Dey et al., 2022a). The  $C_{pm}^*$  is formulated as

$$C_{pm}^* = \frac{U - L}{6\sqrt{\rho^2 + \delta(\gamma, \xi_{0.5})}}, \quad (2)$$

where

$$\delta(\gamma, \xi_p) = 2 \frac{\exp\{\gamma(\xi_p - T)\} - \gamma(\xi_p - T) - 1}{\gamma^2},$$

and  $\rho$  is the half of inter-extreme quantile range

$$\rho = \frac{\xi_b - \xi_a}{2},$$

$\xi_p$  is  $p$ -th quantile of the process and  $\gamma$  is a constant and it determines the asymmetry. Under the theory of normal distribution, the  $C_{pm}^*$  index reduces to  $C'_{pm}$  when  $a=0.1824$  and  $b=0.8629$ . Additionally, the  $C_{pm}^*$  aligns with the conventional  $C_{pm}$  index when  $a=0.1824$ ,  $b=0.8629$  and  $\gamma \rightarrow 0$ . These values for  $a$  and  $b$  can also be applied to non-normal measurements. For detailed information about  $a$  and  $b$ , one can see (Karakaya, 2024). For the rest of this paper, the values  $a=0.25$  and  $b=0.75$  is considered.

Chen distribution, proposed by (Chen, 2000), has a hazard function with either an increasing failure rate or a bathtub shape. Because of its flexibility to exhibit these two shapes, the Chen distribution has been widely used in various reliability and engineering studies. There are many studies related to the Chen distribution with application. Bayesian inference for the Chen distribution is examined by (Srivastava and Kumar, 2011). An extended version of the Chen distribution is proposed by (Bhatti et al., 2019). The Weibull-Chen distribution is introduced by (Tarvirdizade and Ahmadpour, 2019). The half-Cauchy Chen distribution is presented by (Chaudhary et al., 2023).

In this study, statistical inference is considered for the  $C_{pm}^*$  index based on the Chen distribution. The rest of the study is organized as follows: The point and interval estimation for  $C_{pm}^*$  is studied based on the maximum likelihood estimator for Chen distribution in Section “Estimation for  $C_{pm}^*$ ”. In Section “Monte Carlo Simulation Study”, a simulation is conducted to observe the properties of the estimation procedures. An illustrative example is provided in Section “Real Data Analysis”. Finally, some concluding remarks are given in Section “Conclusion”.

### ESTIMATION FOR $C_{pm}^*$

In this section, the point and interval estimation of the  $C_{pm}^*$  is examined. Due to its flexible nature, the Chen distribution is preferred in quality control analysis. The probability density function (pdf) and cumulative distribution of the Chen distribution are presented, respectively, by

$$f(x; \Xi) = \beta \lambda x^{\beta-1} \exp(x^\beta) \exp\left\{\lambda \left[1 - \exp(x^\beta)\right]\right\}; x > 0, \beta > 0; \lambda > 0 \quad (3)$$

and

$$F(x; \Xi) = 1 - \exp\left\{\lambda \left[1 - \exp(x^\beta)\right]\right\},$$

where  $\Xi = (\beta, \lambda)$ . The  $p$ th quantile for Chen distribution is given by

$$\xi_p(\Xi) = \left\{-\log(\lambda) + \log[\lambda - \log(1-p)]\right\}^{1/\beta}. \quad (4)$$

Let  $X_1, X_2, \dots, X_n$  be a random sample from Chen distribution with pdf in Equation (3). Then the log-likelihood function is presented as

$$\ell(\Xi) = n \log(\beta) + n \log(\lambda) + (\beta - 1) \sum_{i=1}^n \log(x_i) + \sum_{i=1}^n x_i^\beta + \sum_{i=1}^n \lambda \left[1 - \exp(x_i^\beta)\right]. \quad (5)$$

The maximum likelihood estimation (MLE) of the parameter  $\Xi$  estimation is achieved by

$$\hat{\Xi} = \arg \max_{(\beta, \lambda) \in \mathbb{R}_+^2} \ell(\Xi),$$

where  $\hat{\Xi} = (\hat{\beta}, \hat{\lambda})$ . Following the invariance principle for MLE, by substituting  $\hat{\beta}$  and  $\hat{\lambda}$  in Equation (2), the MLE for  $C_{pm}^*$  can be derived as follows

$$\hat{C}_{pm}^* = \frac{U - L}{6\sqrt{\hat{\rho}^2 + \delta\{\gamma, \xi_{0.5}(\hat{\Xi})\}}}, \quad (6)$$

where  $\hat{\rho} = \{\xi_b(\hat{\Xi}) - \xi_a(\hat{\Xi})\} / 2$ .

Now, the approximate confidence interval (ACI) based on the Fisher Information principle is constructed. It's well-known that  $\hat{\Xi} \approx AN(\Xi, I^{-1}(\Xi))$ , where  $I$  is the expected Fisher information matrix. Equation (4) and the well-known delta method are used to derive a consistent estimator for the asymptotic variance of  $\hat{C}_{pm}^*$  as follows:

$$\hat{V}(\hat{C}_{pm}^*) = \left(\nabla C_{pm}^*\right)^T I^{-1}(\Xi) \left(\nabla C_{pm}^*\right) \Big|_{\Xi = \hat{\Xi}}.$$

Now, a  $100(1-\alpha)\%$  ACI for  $C_{pm}^*$  is presented as:

$$\left(\hat{C}_{pm}^* - z_{1-\alpha/2} \sqrt{\hat{V}(\hat{C}_{pm}^*)}, \hat{C}_{pm}^* + z_{1-\alpha/2} \sqrt{\hat{V}(\hat{C}_{pm}^*)}\right),$$

where  $z_\alpha$  is the  $\alpha$ -th quantile of the standard normal distribution.

### MONTE CARLO SIMULATION STUDY

In this section, a Monte Carlo simulation study is performed to observe the efficiency of point and interval estimation based on Chen distribution with parameters  $\beta$  and  $\lambda$ . The bias and mean squared error (MSE) of  $C_{pm}^*$  are computed. The coverage probability (CP) and mean length (ML) of the ACI are obtained through simulation. Sample sizes of  $n = 25, 50, 75, 100, 125, 150, 175, 200, 250$ , and  $500$  are considered in the simulation with  $5000$  runs. For the simulation, three different initial values ( $\Xi_1 = (0.5, 0.9)$ ,  $\Xi_2 = (2, 1.5)$ , and  $\Xi_3 = (4, 0.7)$ ) and three different gamma values ( $\gamma = -0.3, 0.01, 0.3$ ) are considered. Furthermore, the process is evaluated in both on-target and off-target conditions. For the on-target case,  $T = E(X)$  is used (where  $X$  is a random variable that follows the Chen distribution,



with the pdf in Equation 3). For the off-target scenario,  $T$  is set to  $E(X) + \tau\sqrt{Var(X)}$ . In this case, the values for  $\tau$  in the off-target scenario are set at  $\tau=1$  and  $\tau=3$ , suggesting that the target is moved off-center by adding 1 or 3 standard deviations. The simulation results are presented in Tables 1-3. From Tables 1-3, it is observed that as the sample size increases, the bias and MSE decrease and approach zero, as expected. Moreover, with in increasing sample size, the CP tends to approach the nominal level of 0.95, and the ML decreases. It is also noted that the point and interval estimates demonstrate consistent results for both on-target and off-target processes.

**Table 1.** The bias, MSE, CP and ML for the on-target process

n	$\bar{x}$	$\gamma = -0.3$				$\gamma = 0.01$				$\gamma = 0.3$			
		Bias	MSE	CP	ML	Bias	MSE	CP	ML	Bias	MSE	CP	ML
25	$\mu_1$	0.0012	0.0065	0.9696	0.3120	0.0007	0.0063	0.9796	0.3107	0.0016	0.0061	0.9762	0.3096
50		-0.0012	0.0027	0.9718	0.2079	0.0003	0.0028	0.9672	0.2078	0.0012	0.0029	0.9688	0.2094
75		-0.0007	0.0018	0.9656	0.1659	0.0012	0.0017	0.9754	0.1662	0.0009	0.0018	0.9700	0.1674
100		0.0001	0.0012	0.9636	0.1409	0.0007	0.0013	0.9636	0.1417	0.0006	0.0013	0.9648	0.1429
125		-0.0006	0.0010	0.9610	0.1245	0.0003	0.0010	0.9610	0.1257	0.0006	0.0010	0.9672	0.1263
150		-0.0001	0.0008	0.9612	0.1128	0.0003	0.0008	0.9650	0.1136	0.0000	0.0008	0.9644	0.1149
175		0.0000	0.0007	0.9636	0.1041	-0.0005	0.0007	0.9626	0.1048	0.0002	0.0007	0.9642	0.1058
200		-0.0003	0.0006	0.9554	0.0969	0.0002	0.0006	0.9604	0.0971	-0.0001	0.0006	0.9598	0.0984
250		0.0003	0.0005	0.9636	0.0861	-0.0001	0.0005	0.9592	0.0868	-0.0004	0.0005	0.9572	0.0881
500		0.0000	0.0002	0.9528	0.0601	-0.0002	0.0002	0.9554	0.0607	0.0001	0.0003	0.9510	0.0614
25	$\mu_2$	0.0077	0.0097	0.9574	0.3871	0.0092	0.0098	0.9590	0.3873	0.0067	0.0105	0.9490	0.3862
50		0.0033	0.0044	0.9580	0.2617	0.0036	0.0044	0.9590	0.2612	0.0034	0.0043	0.9588	0.2617
75		0.0014	0.0028	0.9522	0.2093	0.0033	0.0029	0.9514	0.2097	0.0022	0.0029	0.9546	0.2098
100		0.0026	0.0022	0.9520	0.1797	0.0013	0.0020	0.9570	0.1794	0.0014	0.0022	0.9460	0.1793
125		0.0015	0.0017	0.9518	0.1594	0.0012	0.0017	0.9536	0.1595	0.0014	0.0017	0.9524	0.1594
150		0.0004	0.0014	0.9528	0.1447	0.0013	0.0014	0.9482	0.1448	0.0015	0.0014	0.9506	0.1448
175		0.0004	0.0012	0.9536	0.1333	0.0010	0.0012	0.9474	0.1336	0.0002	0.0011	0.9536	0.1333
200		0.0007	0.0010	0.9518	0.1247	-0.0003	0.0010	0.9518	0.1244	0.0008	0.0010	0.9538	0.1246
250		0.0009	0.0008	0.9450	0.1111	0.0002	0.0008	0.9484	0.1109	0.0000	0.0008	0.9588	0.1108
500		0.0003	0.0004	0.9518	0.0779	0.0003	0.0004	0.9530	0.0779	0.0002	0.0004	0.9510	0.0778
25	$\mu_3$	0.0017	0.0095	0.9528	0.3761	0.0036	0.0099	0.9548	0.3778	0.0012	0.0097	0.9524	0.3756
50		-0.0009	0.0041	0.9512	0.2521	0.0008	0.0041	0.9548	0.2526	0.0014	0.0043	0.9544	0.2533
75		0.0007	0.0026	0.9522	0.2014	0.0002	0.0026	0.9606	0.2018	-0.0002	0.0026	0.9564	0.2011
100		0.0010	0.0020	0.9508	0.1720	0.0002	0.0019	0.9560	0.1720	0.0007	0.0020	0.9478	0.1722
125		-0.0005	0.0014	0.9558	0.1521	-0.0005	0.0015	0.9528	0.1523	0.0008	0.0015	0.9546	0.1521
150		0.0006	0.0013	0.9522	0.1382	0.0004	0.0012	0.9546	0.1382	-0.0001	0.0013	0.9508	0.1381
175		-0.0003	0.0011	0.9504	0.1272	0.0002	0.0010	0.9548	0.1275	-0.0001	0.0011	0.9508	0.1272
200		-0.0001	0.0009	0.9520	0.1186	0.0005	0.0009	0.9558	0.1187	-0.0002	0.0009	0.9494	0.1186
250		-0.0002	0.0007	0.9536	0.1058	0.0002	0.0007	0.9508	0.1056	0.0002	0.0007	0.9500	0.1055
500		0.0002	0.0004	0.9488	0.0738	-0.0002	0.0004	0.9486	0.0737	0.0000	0.0003	0.9538	0.0738

**V. INTERNATIONAL APPLIED STATISTICS CONGRESS (UYIK - 2024)**  
**İstanbul / Türkiye, May 21-23, 2024**

**Table 2.** The bias, MSE, CP and ML for the off-target process with  $\tau = 1$

n	$\mu$	$\gamma = -0.3$				$\gamma = 0.01$				$\gamma = 0.3$			
		Bias	MSE	CP	ML	Bias	MSE	CP	ML	Bias	MSE	CP	ML
25	$\mu_1$	0.0081	0.0015	0.9264	0.1375	0.0073	0.0013	0.9306	0.1292	0.0068	0.0012	0.9276	0.1219
50		0.0032	0.0006	0.9398	0.0951	0.0037	0.0006	0.9374	0.0897	0.0037	0.0005	0.9404	0.0845
75		0.0031	0.0004	0.9420	0.0780	0.0025	0.0004	0.9438	0.0728	0.0021	0.0003	0.9440	0.0682
100		0.0024	0.0003	0.9450	0.0674	0.0019	0.0003	0.9458	0.0629	0.0017	0.0002	0.9430	0.0589
125		0.0017	0.0002	0.9476	0.0600	0.0016	0.0002	0.9478	0.0562	0.0015	0.0002	0.9486	0.0526
150		0.0013	0.0002	0.9518	0.0547	0.0013	0.0002	0.9466	0.0512	0.0013	0.0002	0.9462	0.0480
175		0.0015	0.0002	0.9436	0.0507	0.0010	0.0001	0.9480	0.0473	0.0012	0.0001	0.9498	0.0444
200		0.0012	0.0002	0.9464	0.0474	0.0012	0.0001	0.9472	0.0443	0.0009	0.0001	0.9460	0.0414
250		0.0010	0.0001	0.9420	0.0423	0.0007	0.0001	0.9446	0.0395	0.0008	0.0001	0.9498	0.0370
500		0.0003	0.0001	0.9484	0.0298	0.0003	0.0000	0.9488	0.0278	0.0003	0.0000	0.9504	0.0261
25	$\mu_2$	0.0116	0.0117	0.9478	0.4145	0.0153	0.0124	0.9400	0.4128	0.0163	0.0128	0.9400	0.4130
50		0.0070	0.0058	0.9478	0.2901	0.0081	0.0056	0.9446	0.2892	0.0072	0.0056	0.9442	0.2883
75		0.0072	0.0038	0.9462	0.2372	0.0049	0.0037	0.9470	0.2361	0.0046	0.0037	0.9482	0.2348
100		0.0043	0.0029	0.9420	0.2047	0.0038	0.0028	0.9468	0.2044	0.0027	0.0028	0.9454	0.2033
125		0.0036	0.0022	0.9454	0.1831	0.0023	0.0022	0.9482	0.1823	0.0050	0.0022	0.9506	0.1821
150		0.0042	0.0019	0.9440	0.1676	0.0031	0.0018	0.9492	0.1667	0.0029	0.0018	0.9492	0.1663
175		0.0018	0.0016	0.9444	0.1546	0.0027	0.0015	0.9520	0.1543	0.0038	0.0016	0.9510	0.1537
200		0.0028	0.0014	0.9476	0.1448	0.0013	0.0014	0.9504	0.1440	0.0021	0.0013	0.9528	0.1437
250		0.0019	0.0011	0.9462	0.1295	0.0022	0.0011	0.9498	0.1290	0.0019	0.0011	0.9470	0.1286
500		0.0005	0.0005	0.9524	0.0915	0.0013	0.0005	0.9512	0.0913	0.0008	0.0005	0.9478	0.0909
25	$\mu_3$	0.0146	0.0155	0.9418	0.4687	0.0142	0.0156	0.9412	0.4685	0.0117	0.0148	0.9476	0.4697
50		0.0062	0.0070	0.9474	0.3252	0.0080	0.0070	0.9482	0.3249	0.0059	0.0069	0.9452	0.3260
75		0.0042	0.0047	0.9470	0.2655	0.0048	0.0045	0.9476	0.2647	0.0048	0.0045	0.9462	0.2639
100		0.0031	0.0034	0.9452	0.2293	0.0026	0.0036	0.9420	0.2295	0.0024	0.0034	0.9444	0.2284
125		0.0016	0.0027	0.9516	0.2045	0.0018	0.0027	0.9502	0.2045	0.0026	0.0028	0.9446	0.2037
150		0.0009	0.0023	0.9452	0.1868	0.0028	0.0023	0.9460	0.1864	0.0024	0.0022	0.9450	0.1865
175		0.0016	0.0020	0.9444	0.1731	0.0022	0.0020	0.9390	0.1721	0.0032	0.0020	0.9466	0.1718
200		0.0019	0.0017	0.9502	0.1614	0.0016	0.0018	0.9458	0.1618	0.0013	0.0017	0.9484	0.1612
250		0.0012	0.0014	0.9494	0.1445	0.0012	0.0013	0.9470	0.1442	0.0011	0.0014	0.9470	0.1443
500		0.0002	0.0007	0.9456	0.1021	0.0006	0.0007	0.9478	0.1021	0.0002	0.0007	0.9480	0.1022

**V. INTERNATIONAL APPLIED STATISTICS CONGRESS (UYIK - 2024)**  
**İstanbul / Türkiye, May 21-23, 2024**

**Table 3.** The bias, MSE, CP and ML for the off-target process with  $\tau=3$

n	$\mu$	$\gamma = -0.3$				$\gamma = 0.01$				$\gamma = 0.3$			
		Bias	MSE	CP	ML	Bias	MSE	CP	ML	Bias	MSE	CP	ML
25	$\mu_1$	0.0021	0.0001	0.9244	0.0397	0.0018	0.0001	0.9314	0.0374	0.0022	0.0001	0.9310	0.0359
50		0.0011	0.0001	0.9402	0.0277	0.0012	0.0000	0.9424	0.0264	0.0010	0.0000	0.9434	0.0248
75		0.0007	0.0000	0.9448	0.0224	0.0007	0.0000	0.9388	0.0213	0.0007	0.0000	0.9386	0.0201
100		0.0005	0.0000	0.9432	0.0194	0.0005	0.0000	0.9474	0.0184	0.0005	0.0000	0.9430	0.0174
125		0.0004	0.0000	0.9432	0.0173	0.0003	0.0000	0.9432	0.0164	0.0004	0.0000	0.9478	0.0155
150		0.0004	0.0000	0.9428	0.0158	0.0004	0.0000	0.9460	0.0150	0.0004	0.0000	0.9450	0.0142
175		0.0004	0.0000	0.9500	0.0147	0.0003	0.0000	0.9396	0.0139	0.0003	0.0000	0.9496	0.0131
200		0.0003	0.0000	0.9496	0.0137	0.0003	0.0000	0.9418	0.0130	0.0002	0.0000	0.9456	0.0122
250		0.0003	0.0000	0.9446	0.0122	0.0002	0.0000	0.9456	0.0116	0.0002	0.0000	0.9474	0.0109
500		0.0001	0.0000	0.9506	0.0086	0.0001	0.0000	0.9516	0.0082	0.0001	0.0000	0.9482	0.0077
25	$\mu_2$	0.0203	0.0094	0.9416	0.3481	0.0216	0.0094	0.9364	0.3457	0.0188	0.0085	0.9444	0.3408
50		0.0106	0.0043	0.9422	0.2432	0.0106	0.0041	0.9460	0.2407	0.0101	0.0040	0.9504	0.2383
75		0.0074	0.0027	0.9490	0.1977	0.0063	0.0026	0.9464	0.1950	0.0083	0.0026	0.9486	0.1944
100		0.0045	0.0020	0.9452	0.1701	0.0054	0.0018	0.9542	0.1689	0.0057	0.0020	0.9484	0.1673
125		0.0046	0.0016	0.9472	0.1523	0.0034	0.0015	0.9504	0.1503	0.0052	0.0015	0.9490	0.1496
150		0.0039	0.0013	0.9472	0.1389	0.0032	0.0013	0.9484	0.1372	0.0046	0.0012	0.9510	0.1364
175		0.0031	0.0011	0.9506	0.1284	0.0028	0.0011	0.9464	0.1269	0.0031	0.0011	0.9450	0.1259
200		0.0025	0.0009	0.9494	0.1199	0.0020	0.0009	0.9468	0.1185	0.0020	0.0009	0.9500	0.1174
250		0.0020	0.0008	0.9492	0.1072	0.0020	0.0007	0.9512	0.1061	0.0018	0.0007	0.9488	0.1050
500		0.0012	0.0004	0.9470	0.0757	0.0012	0.0004	0.9528	0.0749	0.0009	0.0004	0.9508	0.0741
25	$\mu_3$	0.0424	0.0270	0.9252	0.5857	0.0335	0.0250	0.9270	0.5774	0.0386	0.0259	0.9282	0.5795
50		0.0202	0.0122	0.9376	0.4100	0.0181	0.0123	0.9366	0.4077	0.0217	0.0120	0.9410	0.4079
75		0.0136	0.0078	0.9440	0.3339	0.0126	0.0078	0.9432	0.3319	0.0129	0.0075	0.9416	0.3311
100		0.0087	0.0055	0.9490	0.2880	0.0101	0.0056	0.9450	0.2874	0.0103	0.0058	0.9402	0.2863
125		0.0087	0.0045	0.9448	0.2576	0.0074	0.0045	0.9456	0.2565	0.0070	0.0044	0.9474	0.2554
150		0.0072	0.0037	0.9488	0.2351	0.0065	0.0038	0.9438	0.2340	0.0064	0.0037	0.9418	0.2331
175		0.0059	0.0032	0.9472	0.2175	0.0056	0.0031	0.9470	0.2165	0.0045	0.0031	0.9462	0.2155
200		0.0058	0.0027	0.9486	0.2036	0.0051	0.0028	0.9460	0.2024	0.0044	0.0027	0.9478	0.2016
250		0.0040	0.0021	0.9494	0.1816	0.0025	0.0022	0.9418	0.1805	0.0035	0.0021	0.9520	0.1801
500		0.0022	0.0011	0.9516	0.1282	0.0010	0.0011	0.9484	0.1275	0.0020	0.0010	0.9546	0.1273



**REAL DATA ANALYSIS**

In this section, a real data analysis is performed to demonstrate the usability of the  $C_{pm}^*$  based on Chen distribution. The data set contains ball size (in mm), a critical component of wire bonding that establishes an electronic connection from the integrated circuit device to the lead frame. Detailed information about the ball size data set can be found in (Leiva et al., 2014). The ball size data is 2,3,5. The ball size data is 2.891, 4.035, 4.495, 2.890, 2.312, 3.158, 5.228, 3.334, 5.896, 5.639, 3.842, 1.590, 1.954, 1.842, 0.680, 2.752, 1.301, 2.260, 0.889, 2.381, 0.619, 2.788, 1.050, 3.750, 3.508, 6.123, 6.549, 5.954, 2.207, 4.417, 4.805, 1.516, 2.227, 2.797, 1.636, 1.066, 0.940, 4.101, 4.542, 1.295, 1.770, 3.492, 5.706, 3.722, 6.644, 2.472, 1.383, 4.494, 1.694, 2.892, 2.111, 3.591, 2.093, 3.222, 2.891, 2.582, 0.665, 3.234, 1.102, 1.083, 1.508, 1.811, 2.803, 6.659, 0.923, 6.229, 3.177, 2.333, 1.311, 4.419, 2.495, 0.921, 4.061, 9.725, 1.600, 4.281, 3.360, 1.131, 1.618, 4.489, 3.696, 1.982, 2.413, 5.480, 1.992, 2.573, 1.845, 4.620, 6.221, 1.694, 4.882, 1.380, 3.982, 2.260, 2.366, 2.899, 3.782, 2.336, 1.175, 3.055. The ball size data is also assessed in (Dey et al., 2022b) using the  $S_{pmk}$ . In (Dey et al., 2022b), the specification limits and target value are defined as  $L=0.5, U=8.0$  and  $T=3$  for ball size data, and these values are also used in the real data analysis for  $C_{pm}^*$ . Now,  $C_{pm}^*$  is assessed under the assumption that the data follow a Chen distribution. The MLE for parameters of the Chen distribution parameters are obtained as  $\hat{\mathbf{E}}=(0.6679,0.1037)$ . The Kolmogorov-Smirnov (KS) test is conducted to assess how well the Chen distribution fits the ball size data. The KS test statistic is 0.1159, with an associated p-value of 0.1360. The KS results indicate that the Chen distribution is a good fit for the ball size data. The  $\hat{C}_{pm}^*$  and ACIs are computed and presented in Table 4 for some choices of  $\gamma$  and  $\tau$ . Table 4 shows that  $C_{pm}^*$  is not significantly impacted by changes in  $\gamma$  and  $\tau$ . Additionally, the confidence limits for ACI do not appear to be significantly affected by  $\gamma$  and  $\tau$ .

**Table 4.** The confidence limits for ACI of  $C_{pm}^*$  under Chen distribution

$\tau$	$\gamma$	$C_{pm}^*$	Confidence limits for ACI
0	-0.3	0.9116	(0.8223, 1.0009)
	0.01	0.9116	(0.8223, 1.0009)
	0.3	0.9117	(0.8223, 1.0010)
1	-0.3	0.9116	(0.8223, 1.0009)
	0.01	0.9116	(0.8223, 1.0009)
	0.3	0.9117	(0.8223, 1.0010)
3	-0.3	0.9116	(0.8223, 1.0009)
	0.01	0.9116	(0.8223, 1.0009)
	0.3	0.9117	(0.8223, 1.0010)

**CONCLUSION**

In this study, the  $C_{pm}^*$  index proposed by (Karakaya, 2024) is investigated based on the Chen distribution. The point estimate for  $C_{pm}^*$  is derived using the invariance property of MLE. The confidence interval for  $C_{pm}^*$  is obtained based on the Fisher Information principle. The performance of

the estimators for both the point estimate and the confidence interval is evaluated through a Monte Carlo simulation under different scenarios. Furthermore, the applicability of the  $C_{pm}^*$  index is demonstrated using ball size data based on the Chen distribution.

## REFERENCES

- Bhatti FA, Hamedani GG, Najibi SM, Ahmad M, 2019. On the extended Chen distribution: development, properties, characterizations and applications. *Annals of Data Science*, 8: 159-180.
- Chan LK, Cheng SW, Siring FA, 1988. A new measure of process capability:  $C_{pm}$ . *J Qual Technol*, 20 (3): 162-175.
- Chaudhary AK, Yadav RS, Kumar V, 2023. Half-Cauchy Chen Distribution with Theories and Applications. *Journal of Institute of Science and Technology*, 28 (1): 45-55.
- Chen Z, 2000. A new two-parameter lifetime distribution with bathtub shape or increasing failure rate function. *Statistics & Probability Letters*, 49 (2): 155-161.
- Dey S, Wang L, Saha M, 2022a. Modified estimation and confidence intervals of an asymmetric loss-based process capability index  $C'_{pm}$ . *Qual Reliab Eng Int*, 38 (8): 4033-48.
- Dey S, Saha M, Kumar S, 2022b. Parametric confidence intervals of  $S_{pmk}$  for generalized exponential distribution. *Am J Math Manag Sci*, 41 (3): 201-22.
- Hsiang TC, Taguchi G, 1985. A tutorial on quality control and assurance. In: Annual Meeting on the American Statistical Association, NV (unpublished presentation), Las Vegas.
- Juran JM, 1974. *Juran's Quality Control Handbook*. 3rd ed., McGraw-Hill, New York.
- Kane VE, 1986. Process capability indices. *J Qual Technol*, 18 (1): 41-52, New York.
- Karakaya K, 2024. A general novel process capability index for normal and non-normal measurements. *Ain Shams Engineering Journal*, 15 (6): 102753.
- Leiva V, Marchant C, Saulo H, Aslam M, Rojas F, 2014. Capability indices for Birnbaum-Saunders processes applied to electronic and food industries. *J Appl Stat*, 41 (9): 1881-902.
- Pearn WL, Kotz S, Johnson NL, 1992. Distributional and inferential properties of process capability indices. *J Qual Technol*, 24 (4): 216-31.
- Srivastava AK, Kumar V, 2011. Markov Chain Monte Carlo methods for Bayesian inference of the Chen model. *International Journal of Computer Information Systems*, 2 (2): 07-14.
- Tarvirdizade B, Ahmadpour M, 2019. A new extension of Chen distribution with applications to lifetime data. *Communications in Mathematics and Statistics*, 9 (1): 23-38.

**Excretion in Patients with Stroke and Factors Affecting**

**\*Sahizer Eraydin<sup>1(\*)</sup>, Gül Baş<sup>2</sup>**

<sup>1</sup>Tokat Gaziosmanpaşa University, Faculty of Health Sciences, Department of Nursing, Department of Fundamentals of Nursing, Tokat, Türkiye.

<sup>2</sup>Taşova State Hospital. Taşova. Türkiye.

Corresponding author e-mail: sahizer.eraydin@gop.edu.tr

**Abstract**

**Introduction:** Every year, nearly 18 million new stroke cases occur worldwide, causing permanent disability or death, and 6 million people die due to stroke. Stroke constitutes a significant health problem all over the world. Along with many other problems, excretion problems are also observed in stroke patients. These include constipation, fecal obstruction, fecal incontinence, urinary incontinence, and infection, which are related to bowel evacuation. Excretion problems reduce the quality of life in stroke patients and negatively affect the course of the disease.

**Objective:** This research was conducted to determine the excretory processes and affecting factors of patients diagnosed with stroke.

**Method:** This research was conducted as a descriptive-cross-sectional study. For the research, informed consent was obtained from the patients, institutional permission was obtained, and ethics committee permission was obtained. The research was carried out in the neurology outpatient clinic and clinic of a university hospital. Patients diagnosed with stroke, aged between 20 and 80, who could be contacted and volunteered to participate in the study, were included in the study. The data of the research was collected face to face via a survey form. The data were evaluated with the SPSS 25 program. Kurtosis and skewness values were used for normal distribution. Data were presented as frequency, number, percentage and mean. Chi-square test and t test were used for pairwise comparisons.

**Results:** The average age of the patients was  $65.36 \pm 10.9$  ( $n=50$ ) and the average BMI was  $27.12 \pm 4.76$ . 28% of the patients are women and 72% are men. 76% are married. 38% are primary school graduates. 46% of them live in the city center. 66% of the patients are from the low-income group and 78% have at least one chronic disease. 32% of patients are bedridden. 66% of patients have urinary problems. 71% of women and 50% of men have had a urinary tract infection. 62% of them have a urinary catheter for excretion. 36% of patients have fecal incontinence. Constipation develops in 46%. 56% feel abdominal tension. Abdominal abdominal pain occurs in 32% of cases. Presence of stool was detected in 38% of cases during abdominal examination. 57% of women and 33% of men use laxative drugs for bowel obstruction. Only 20% of patients receive sufficient fluid to solve their excretion problems. Adequate fiber food intake is 40%. Adequate movement is 20%. Adequate walking is 16%.

**Conclusion:** One-third of the patients participating in the study were bedridden and two-thirds used a urinary catheter. Stroke patients largely experience excretion problems. Women have many urinary evacuation problems. Applications to improve patients' intestinal evacuation problems are inadequate.

**Keywords:** Stroke, bowel evacuation, urinary evacuation, incontinence, constipation.

**INTRODUCTION**

Stroke is a clinical condition that occurs when the blood supply to the brain is blocked or reduced as a result of blockage of blood vessels or bleeding. Individuals diagnosed with stroke may weaken or lose many functions depending on the brain region affected by the disease. They may experience physical or psychological deficits such as speaking, walking, and moving (Bellikci et al, 2016). Every year, nearly 18 million new strokes that cause permanent disability or death occur worldwide and 6 million people die due to stroke. Stroke is a major health problem worldwide. Every year, stroke-related deaths rank second among all causes of death in the world. Along with many other problems, stroke patients also have excretory problems (Camara et al., 2014). These include constipation, fecal plug, fecal incontinence, urinary incontinence and infection for intestinal emptying (Camara et al., 2014; Bellikci et al, 2016; Harari et al, 2004).



The most common medical complications after stroke are urinary tract infection 15.5% and constipation 7.0% (Ingeman, 2011). Fecal incontinence affects  $\leq 56\%$  of individuals acutely after stroke, 11% at 3 months and 22% at 12 months. Fecal incontinence may also develop months after acute stroke and may be transient, and as a possible cause, it may develop as bowel dysfunction after constipation (Harari et al, 2004; Demirbaş, 2010). Constipation in stroke patients not only affects the quality of life of patients, but also hinders the recovery process after stroke; it may even cause recurrence of cerebrovascular diseases (Yang et al, 2019; Çevik et al, 2018). Post-stroke constipation has been reported due to altered anorectal motility and rectal sensation. In patients with brain stem lesions, impairment in the nerves going from the rectum to the brain increased the susceptibility to constipation. Decreased sensory desire to defecate and decreased physical activity level were considered as factors associated with post-stroke constipation (Cheng et al, 2019).

Bowel dysfunction is a common condition after stroke (Harari et al, 2004). A small-sample study examining gastro intestinal tract (GIS) complications after stroke found that GIS symptom occurred regardless of physical activity or hemisphere (Bellikci et al, 2016). Larger, community-based studies have found an incidence of 7% among patients admitted to stroke units. Bowel dysfunction has been reported to be as high as 55% in the first 4 weeks after ischemic stroke and up to 30% after 3 months (Su et al, 2009).

Excretory problems in patients with stroke reduce the patient's comfort and quality of life and negatively affect the course of the disease (Bellikci et al, 2016). It is important to identify the problems to minimize the problems experienced by the patient. As a result of this study, it was thought to determine the excretory problems experienced by stroke patients, to determine the medication or non-medication applications they use for excretion, and to determine the effect of the drugs used in their treatment on excretion. It is foreseen that this study will guide future researches.

**Objective:** This study was planned to determine the excretory processes of patients diagnosed with stroke and the factors affecting them.

#### **Research questions**

1. How is the excretory status in stroke patients?
2. What are the factors affecting bowel and urinary excretion in stroke patients?

#### **MATERIALS AND METHODS**

**Type of Study** = This study is descriptive-cross-sectional.

**Place and Time of the Study** = The study was conducted in the neurology clinic of a university hospital in the Black Sea region over a period of three months.

**Population and Sample of the Study**= The population of the study consisted of all patients diagnosed with stroke hospitalized in the neurology clinic between the dates mentioned above. All patients will be tried to be reached in the study. The sample included individuals who were admitted to the neurology clinic with a diagnosis of stroke, who were 20 years of age or older, who were open to communication, and who agreed to participate in the study.

**Data Collection**= The questionnaire form and face-to-face interview method were applied to the patients.

**Data Collection Tools**= The data of the study were collected with a questionnaire form created by the researchers based on the literature. The questionnaire form consisted of two parts. In the first part, there are questions to define the demographic and disease characteristics of the patients. In the second part, there are questions about bowel and urinary excretion characteristics.

**Data Evaluation**= The data were evaluated in SPSS 25 package program. Data were presented as numbers, percentages and averages. T test and chi-square test were used for comparisons.

**Ethical Aspects of the Study**= Permission numbered 21-KAET-136 was obtained from the Clinical Research Ethics Committee, permission was obtained from the Hospital Administration and written and verbal consent was obtained from the patients. The principles of the Declaration of Helsinki were

followed in the conduct of the study.

## RESULTS

Demographic characteristics of the patients in our study are given in Table 1. The mean age of the patients was  $65.36 \pm 10.9$  years and mean BMI was  $27.12 \pm 4.76$ . 28% of the patients were female and 72% were male. 76% were married. 38% were primary school graduates. 46% lived in the city center and 44% lived in the district. 66% of the patients were from low income groups, 78% had at least one chronic disease, 60% were retired, 22% were housewives. 32% of the patients were bedridden (Table 1).

**Table1.** Demographic Characteristics (n=50)

	Mean	SD	Min	Max
<b>Age</b>	65,36	10,9	35	80
<b>Body mass index (BMI)</b>	27,12	4,76	19,88	45,79
		n	%	
Gender	Female	14	28	
	Male	36	72	
Marital status	Married	38	76	
	Single	12	24	
Education	illiterate	2	4	
	Literate	11	22	
	Primary school	19	38	
	Secondary school	6	12	
Place of residence	High school	7	14	
	College	5	10	
	Province	23	46	
	District	22	44	
Income status	Village -town	5	10	
	Income is Lower than Expenses	33	66	
	Income Equals Expenditure	17	34	
Chronic diseases	Yes	39	78	
	No	11	22	
Profession	Housewife	11	22	
	Retired	30	60	
	Officer	2	4	
	Employee	3	6	
	Other	4	8	
Being bedrid	Yes	16	32	
	No	34	68	

Fecal incontinence was found in 36% of patients, constipation in 46%, abdominal tension in 56%, abdominal abdominal pain in 32% and presence of stool on abdominal examination in 38%. 26% experienced straining during defecation. 2% experienced bleeding and pain in the rectum. They had problems with urinary excretion. 66% of the patients had urinary problems, 56% had urinary tract infections, 52% had urinary incontinence and 62% had urinary catheterization. 18% of the patients had a practice for urinary problems (Table 2).

**Table2.** Excretory characteristics of patients (n=50)

			<b>n</b>	<b>%</b>
<b>Intestinal evacuation</b>	Fecal Incontinence	Yes	18	36
		No	32	64
	Constipation	Yes	23	46
		No	27	54
	Presence of stool on abdominal examination	Yes	19	38
		No	31	62
	Abdominal tension	Yes	28	56
		No	22	44
	Abdominal pain	Yes	16	32
		No	34	68
	Straining	Yes	26	52
		No	24	48
	Rectal Bleeding and pain	Yes	2	4
		No	48	96
Laxative use	Yes	20	40	
	No	30	60	
<b>Urinary excretion</b>	urinary problem	Yes	33	66
		No	17	34
	Using a urinary catheter	Yes	31	62
		No	19	38
	<b>Urinary tract infection</b>	Yes	28	56
		No	22	44
	Urinary incontinence	Yes	26	52
		No	24	48
	Do not apply for urinary problems	Yes	9	18
		No	41	82

Measures to prevent the development of bowel evacuation problems are shown in table 3. Adequate fluid intake is 20% of patients. Adequate fiber food intake is 40%. Adequate movement is 20%. Adequate walking is 16%. Regular nutrition is 78%. Trying to prevent constipation is 36%. 40% of patients use laxatives for bowel emptying (Table 3).

**Table 3.** Preventive measures to prevent the development of excretion problems

<b>Features</b>		<b>n</b>	<b>%</b>
Adequate Fluid Intake	Yes	10	20
	No	40	80
Adequate Fiber Food Intake	Yes	20	40
	No	30	60
Adequate Movement	Yes	10	20
	No	40	80
Adequate Walking	Yes	8	16
	No	42	84
Regular Nutrition	Yes	39	78
	No	11	22
Trying to Prevent Constipation	Yes	18	36
	No	32	64



## DISCUSSION AND CONCLUSION

In our study, in which we examined the excretory status, excretory problems and factors affecting excretion in stroke patients, it was observed that the patients had excretory problems to a great extent. In our study, 46% of patients had constipation, 56% had abdominal tension, 32% had abdominal pain and 38% had stool in abdominal examination. 26% had straining during defecation, 2% had bleeding and pain in the rectum. Constipation and problems related to constipation were seen intensively in our study. Constipation is the condition of passing hard, dry and small amounts of stool less than 3 times a week, accompanied by difficulty during defecation, bloating and abdominal fullness as a result of changes in general bowel movements (Camara et al., 2014).

There are many reasons why constipation develops. These include; constant lying or inactivity, fatigue, loss of appetite, malnutrition and inadequate fluid intake, difficulty in accessing the toilet, fear of incontinence, positioning of the emptying site (diaper/sliding), decreased abdominal muscle strength, past negative experiences, depression, anxiety, opioid use, antiemetics, antidepressants, diuretics, antacids, iron preparations, use of non-steroidal anti-inflammatory drugs, hemorrhoids and anal fissures, cerebral tumors, compression of the spinal cord, hypercalcemia, hypokalemia, abdominal tumors, endocrine disorders such as hypothyroidism (Sykes et al, 2016; Cheng et al, 2019). In our study, there are many factors that cause constipation in patients with stroke.

When left untreated, constipation can cause health problems such as back and lower back pain, rectal pressure, anorexia, incontinence, confusion, nausea and vomiting, urinary dysfunction, fissures, rectal prolapse, hemorrhoids, bowel obstruction and syncope (Camara et al., 2014; Harari et al, 2004). Indeed, some of our patients experienced straining, rectal bleeding and pain. Constipation can be treated with and without medication. Drug treatment usually includes the use of stool softeners, prokinetics, osmotic and stimulant laxatives, and fiber supplements (Bellikci et al, 2016).

In our study, 40% of patients used laxatives. These drugs usually have side effects such as bloating, nausea and diarrhea (Yang et al, 2019; Çevik et al, 2018). Due to the negative effects of the above-mentioned treatment methods, a treatment method with fewer side effects should be used (Yıldırım et al, 2019; Wang et al, 2020). In stroke, constipation and fecal incontinence negatively affect social functionality and quality of life (Bellikci et al, 2016). Constipation is considered a serious problem in clinical practice and affects 60% of those in stroke rehabilitation services (Harari et al, 2004; Su et al, 2009). Among post-stroke patients in rehabilitation centers, the incidence of constipation is close to 80% and even higher with almost universal use of laxatives (Lin et al, 2011).

Non-pharmacologic treatment approaches for constipation include dietary modification, increasing fluid intake, bowel training, abdominal massage and increased mobility and lifestyle changes. As a matter of fact, our patients are very deficient in walking, drinking enough fluids, taking fiber foods, and getting enough exercise. Ensuring the privacy of the individual during defecation, increasing comfort, making arrangements according to the individual in liquid and fiber food intake, increasing movement, taking into account the medications used and using prophylactic laxatives when necessary are recommended according to the patient's condition in preventing constipation (Kaya, 2019). Constipation is one of the most common complications of acute stroke. The prevalence is 55% in the acute period within one month after the first stroke and 30% after 36 weeks after stroke onset ( Su et al, 2009; Camara et al., 2014).

Urinary excretory problems are common after stroke. Urinary incontinence, urinary catheterization and urinary infection are common in our patients. Characteristics that make stroke patients more prone to catheter placement include high bladder dysfunction, limited mobility and impaired ability to communicate urination needs. Urinary tract infections are common after acute stroke (Stott et al.,2009;

Westendorp et al,2011). Urinary tract infection is the most common healthcare-associated infection, accounting for 40% of all nosocomial infections. This is mainly caused by catheterization of the lower urinary tract (Stenzelius et al,2016). The cause of infection in this patient group is associated with urinary catheterization, immobility after stroke, lack of care, disability and advanced age. (Stott et al.,2009; Poisson et al,2010; Westendorp et al,2011). A quarter of all hospitalized patients undergo urinary catheterization. Urine is colonized by bacteria within a few days, at a rate of 5-7% per day. After only 3 days, bacterial colonies are seen in the urine of 10-25% of patients (Stenzelius et al,2016).

### Conclusion

Stroke patients have a high rate of excretory problems. Patients were found to experience constipation and problems with urinary and bowel management. One third of the patients were bedridden and two thirds were using urinary catheters. Women were more likely to experience urinary evacuation problems. Practices to improve patients' bowel and urinary elimination problems are inadequate.

### REFERENCES

- Bellikci Koyu E, Kaner G, Akal Yıldız E, 2026. " Stroke and the effect of nutrition on stroke." *Gümüşhane University Journal of Health Sciences*. 5.4 : 112-118.
- Camara-Lemarro C R, Ibarra-Yruegas BE, Gongora-Rivera F., 2014. Gastrointestinal complications after ischemic stroke. *Journal of the Neurological Sciences* 346. 20–25. <http://dx.doi.org/10.1016/j.jns.2014.08.027>.
- Cheng J, Li L, Xu F, Xu Y, Lin L, Chen JD.,2020. Poststroke constipation is associated with impaired rectal sensation. *Official journal of the American College of Gastroenterology*. *ACG*, 115(1), 105-114.
- Çevik K, Çetinkaya A, Gökbel KY, Menekşe B, Saza S, Tıkız C, 2018. The effect of abdominal massage on constipation in the elderly residing in rest homes. *Gastroenterology Nursing*, 41(5), 396-402.
- Demirbaş S. 2010. " Chronic constipation causes, diagnostic methods and treatment approaches. *Gülhane Medical Journal*, 52, 61-68.
- Harari D, Norton C, Lockwood L, Swift C. 2004. Treatment of constipation and fecal incontinence in stroke patients randomized controlled trial. *Stroke*, 35(11), 2549-2555. DOI:10.1161/01.STR.0000144684.46826.62.
- Ingeman A, Andersen G, Hundborg HH, Svendsen ML, Johnsen SP. 2011. Processes of care and medical complications in patients with stroke. *Stroke*. 42:167–72.
- Kaya H. 2019. Constipation and Nursing Care. (Akçakaya A, Başbüyük M, Aydoğdu İ, Uysal AM. Editör.) *Palliative Care and Medicine*. Istanbul Medical Bookstores. 119-122.
- Lin CJ, Hung JW, Cho CY, Tseng CY, Chen HY, Lin FC, et al. 2013. Poststroke constipation in the rehabilitation ward: incidence, clinical course and associated factors. *Singapore Med J*. 54: 624–629.
- Poisson SN, Johnston SC, Josephson SA. 2010. Urinary tract infections complicating stroke: mechanisms, consequences, and possible solutions. *Stroke*, 41:180–4.
- Stenzelius K, Laszlo L, Madeja M, Pessah-Rasmusson H, Grab M. 2016. Catheter-associated urinary tract infections and other infections in patients hospitalized for acute stroke: A prospective cohort study of two different silicone catheters. *Scandinavian Journal of Urology*, 50(6), 483–488. <http://dx.doi.org/10.1080/21681805.2016.1194459>.
- Stott DJ, Falconer A, Miller H, Tilston JC, Langhorne P. 2009. Urinary tract infection after stroke. *QJM*, 102:243–9.
- Su Y, Zhang X, Zeng J, Pei Z, Cheung RT, Zhou QP, et al. 2009. New-onset constipation at acute stage after first stroke: incidence, risk factors, and impact on the stroke outcome. *Stroke*. 40:1304–9.
- Sykes N, Ripamonti C, Bruera D, Gordon D. 2016. Constipation, Diarrhoea, and Intestinal Obstruction. Fallon M, Hank G, Edited. *ABC of Palliative Care*. Second Edition. Blackwell Publishing. 29-30.
- Wang QS, Liu Y, Zou XN, Ma YL, Liu GL. 2020. Evaluating the Efficacy of Massage Intervention for the Treatment of Poststroke Constipation: A Meta-Analysis. *Evidence-Based Complementary and Alternative Medicine*. ID 8934751:(1-8), <https://doi.org/10.1155/2020/8934751>.
- Westendorp WF, Nederkoorn PJ, Vermeij JD, Dijkgraaf MG, van de Beek D. 2011. Post-stroke infection: a systematic review and meta-analysis. *BMC Neurolj*;11:110.

Yang S. Chen J. Guo Y, et al. 2019. "Comparison of Tai ji and aerobic exercise for functional constipation: study protocol for a randomised controlled neuroimaging trial," *BMJ Open*, 9(8), ID: e031089.

Yıldırım D, Can GG, Talu K. 2019. "Efficacy of abdominal massage in managing opioid-induced constipation," *e European Journal of Oncology Nursing*, (41):110–119.

**Acknowledgment**

We thank all the patients who participated in our study.

**Conflict of Interest**

"The authors have declared that there is no conflict of interest".

**Author Contributions**

**ŞE:** Study design, study management, data collection, data evaluation, interpretation, writing the article

**GB:** Study design, data collection.





## Analysis of Urban Traffic Dynamics at a Roundabout: A Case Study in Tirana

**Veranda Syl**<sup>1\*</sup>, **Algenti Lala**<sup>1</sup>, **Aleksandër Biberaj**<sup>1</sup>

<sup>1</sup>Polytechnic University of Tirana, Faculty of Information Technology, Department of Electronics and Telecommunications, Tirana, Albania

\*Corresponding author e-mail: \*vsyla@fti.edu.al

### *Abstract*

*Efficient urban traffic management is critical for reducing congestion and enhancing transportation systems. This paper examines the traffic dynamics at the roundabout near the Faculty of Economics in Tirana, analyzing potential measures to increase its capacity. We conducted a comprehensive study using the VISSIM traffic simulation software to evaluate various traffic scenarios at this roundabout. Our approach involved simulating different traffic conditions to assess flow dynamics, queue lengths, and vehicle delays across two scenarios. In the first scenario, we analyzed the current traffic situation. In the second scenario, we explored the impact of relocating a pedestrian crossing. The findings reveal significant problems, especially during peak congestion times, and indicate that relocating the pedestrian crossing can improve traffic flow and increase roundabout capacity. Based on these insights, we propose specific intervention to improve traffic flow and reduce accidents like enhancing pedestrian crossings. This case study not only highlights the unique challenges of managing traffic at the Tirana roundabout but also underscores the critical role of simulation tools like VISSIM in urban traffic management. The findings and recommendations provided herein offer valuable insights and practical solutions that are applicable to similar urban environments globally, promoting more sustainable and efficient urban traffic systems.*

**Keywords:** Capacity, Roundabout, Traffic Management, PTV Vissim

### **INTRODUCTION**

In Albania, the prevalence of roundabouts has historically been low, but a discernible shift toward their increased construction has occurred in recent years, reflecting a broader trend toward adopting roundabouts for effective traffic management at intersections. This is particularly evident in Tirana, where rapid urbanization and a significant increase in vehicle ownership have led to escalating traffic volumes that strain existing infrastructure.

Most roundabouts and intersections in Tirana encounter considerable capacity challenges, largely attributable to a rapid increase in traffic. This increase has not been matched by a corresponding development in infrastructure, leading to severe congestion issues. As traffic volumes continue to grow and congestion exceeds the capacity of the road network, roundabouts have become significant bottlenecks.

Addressing these challenges is crucial. There is a pressing need to explore and implement strategies that enhance the capacity and performance of these roundabouts. Improving these critical junctions is vital not only for improving traffic flow but also for enhancing the safety and overall efficiency of the urban road network. Enhancements in roundabout management and design could significantly reduce traffic delays, lower accident rates, and improve air quality by reducing idling times (Wang & al., 2022), (Pratelli, 2006).

Furthermore, optimizing traffic flow through roundabouts aligns with broader urban planning objectives, such as promoting sustainable transportation modes and enhancing urban life quality.

Therefore, this paper will identify and analyze targeted interventions that could alleviate the congestion issues faced by Tirana's roundabouts. Using advanced simulation tools and thorough traffic flow analysis, this study aims to propose practical, evidence-based solutions. This paper is organized as follows: Section Two describes related work on the urban traffic dynamics of roundabouts and Section Three details the methodology used in the study. In Section Four, we present the results of simulations for the two scenarios. Finally, Section Five concludes the paper.

## **RELATED WORK**

The study of roundabouts and their impact on urban traffic dynamics has been the subject of extensive research in recent years. This section reviews relevant literature on roundabout capacity, safety, and optimization strategies to provide a comprehensive background for the current study (F. Alphan, et al., 1991).

### **Capacity and Efficiency of Roundabouts**

Several studies have highlighted the capacity challenges faced by roundabouts, especially in urban settings experiencing rapid growth. (Fortuijn, 2009) and (Kimber R., 1980) examined the capacity of turbo roundabouts and proposed methods for estimating their capacity, demonstrating that roundabout designs can significantly influence their performance under high traffic volumes. Similarly, research by (Gkyrtis, K., & Kokkalis, A., 2024) emphasized the importance of geometric design in maximizing roundabout efficiency and reducing congestion.

### **Sustainable Urban Planning and Traffic Management**

Integrating roundabouts into broader urban planning objectives has been shown to promote sustainable transportation and enhance urban life quality. Research by (Tao, Xingyu, et al., 2024) highlighted the role of machine learning and big data in optimizing traffic flow predictions, thereby supporting proactive traffic management strategies that align with the goals of smart cities. The study demonstrated how advanced simulation tools and predictive models can reduce congestion and emissions, contributing to more sustainable urban environments.

### **Advanced Traffic Simulation and Management**

The use of traffic simulation software, such as VISSIM, has become a standard approach for evaluating and improving roundabout performance. (Alma & Shehu, 2016) conducted a performance analysis of roundabouts using simulation tools to identify congestion issues and propose targeted interventions. This methodology allows for detailed analysis of traffic flow dynamics, queue lengths, and vehicle delays, providing a robust framework for implementing evidence-based improvements.

### **Intelligent Traffic Management Systems**

The deployment of intelligent traffic management systems (ITS) has shown promising results in enhancing roundabout efficiency and safety. Studies by the Federal Highway Administration (FHWA) have demonstrated that ITS can effectively manage traffic flows and reduce delays by using real-time data to adjust signal timings and control traffic patterns. These systems are particularly useful in urban areas where traffic conditions are constantly changing (Smith, 2022).

The existing body of research underscores the importance of optimizing roundabout design and management to address capacity and safety challenges in urban settings. By leveraging advanced simulation tools and intelligent traffic management systems, cities can enhance the performance of roundabouts, contributing to more efficient and sustainable urban transportation networks. The current study builds on this foundation, focusing on the specific context of Tirana to propose practical solutions for improving traffic dynamics at a key roundabout.



## METHODOLOGY

To accurately model the roundabout network and its surroundings, employing a scaled map as a background is essential. For this study, a Google Earth map of the area around the Faculty of Economics in Tirana was utilized. To ensure that the model's background reflects real-world dimensions accurately, it was necessary to adjust the software scale to match that of the Google Earth map.

Once the scale adjustment was completed, the process of network mapping could commence. This approach ensures that the grid elements used in the model maintain the same scale as the background image. Consequently, this precision allows for accurate tracking of infrastructure elements such as roundabouts and roads, facilitating detailed analysis of traffic dynamics and potential interventions for capacity improvement. This methodological framework lays the groundwork for subsequent simulations and analyses, driving insightful conclusions about traffic management at the studied roundabout. This revised section enhances clarity by streamlining the process and emphasizing the importance of scale accuracy in modeling traffic analysis.

### Data Collection

To accurately model the roundabout network and its surroundings, a scaled map was employed as a background. A Google Earth map of the area near the Faculty of Economics in Tirana was utilized for this purpose. Ensuring that the model's background reflects real-world dimensions accurately was crucial. Therefore, the scale of the software was adjusted to match the scale of the Google Earth map. Once the scaling adjustment was completed, the process of network mapping commenced. This approach ensured that the grid elements used in the model maintained the same scale as the background image, allowing for precise tracking of infrastructure elements such as roundabouts and roads, thereby facilitating a detailed analysis of traffic dynamics and potential interventions for capacity improvement.



**Figure 1.** Scaled map of the roundabout area [Source: Google Earth in PTV VISSIM]

### Traffic Flow Simulation

For simulating different traffic scenarios and analyzing flow dynamics, queue lengths, and vehicle delays, the VISSIM traffic simulation software was employed. VISSIM is a microscopic, time step, and behavior-based simulation model developed to provide detailed insights into the interactions between vehicles and pedestrians in a given traffic network. The simulation included various scenarios to account for peak and off-peak traffic conditions, considering different types of vehicles and pedestrian movements (PTV Group, 2015).

### Scenario Development

Two scenarios were developed to evaluate the performance of the roundabout under different conditions. Performance metrics such as delay, average queue length, and capacity were examined in each scenario.



### *Scenario 1: Current Situation*

In this scenario analyzed the existing conditions of the roundabout. Data on traffic volumes, vehicle types, and pedestrian movements were collected through field observations and existing traffic reports. This scenario served as the baseline for comparison with the other scenario.



**Figure 2.** Current Situation of the Roundabout near the Faculty of Economics in Tirana

### *Scenario 2: Change of the Location of the Pedestrian Crossing*

In this scenario, the pedestrian crossing was relocated to assess its impact on traffic flow and safety. The new location was strategically chosen to minimize interference with vehicle movement while ensuring pedestrian accessibility and safety.



**Figure 3.** Changing the location of the pedestrian crossing

### *Calibration and Validation*

The model calibration process involved adjusting the simulation parameters to match real-world observations. Key parameters such as vehicle arrival rates, acceleration and deceleration behaviors, and pedestrian walking speeds were fine-tuned based on field data. The calibration aim to ensure that the simulated traffic flow closely mirrored actual traffic conditions observed at the roundabout. Validation of the model was conducted by comparing the simulation outputs with observed traffic performance metrics, such as average queue lengths, vehicle delays, and traffic flow rates.

## **RESULTS OF SIMULATIONS**

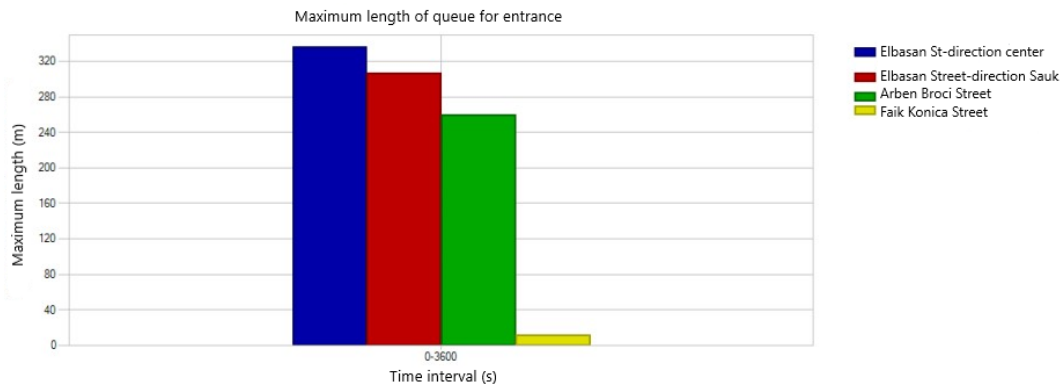
### **Scenario 1**

#### *Maximum Queue Length*

The time interval in the below graph (0-3600s) corresponds to the peak hour from 08:00 to 09:00. Figure 4 illustrates the maximum queue length (in meters) at each roundabout entrance during this simulation period. As anticipated, the longest queues form during peak hours. However, it is observed that the largest queues sometimes occur shortly after the peak hour. This phenomenon is attributed to the

cumulative effect of vehicle arrivals during the peak traffic period.

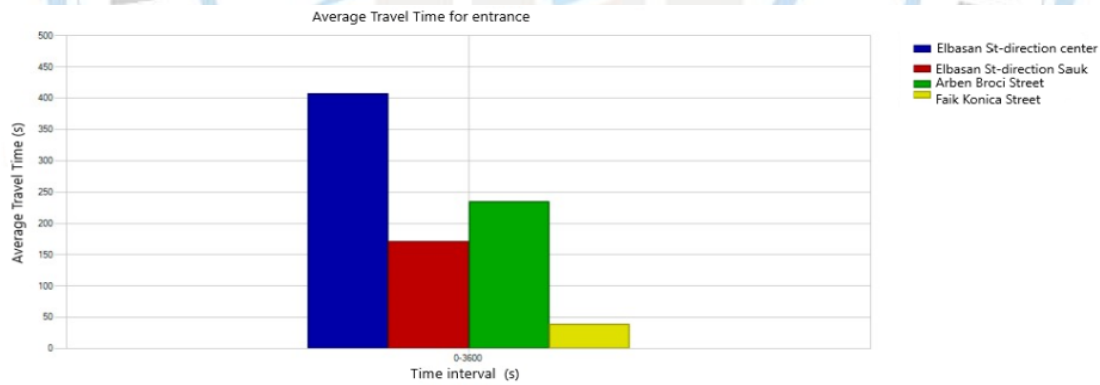
During the morning peak, the longest queue is recorded at the entrance of “Elbasan” Street heading towards the city center, with a maximum length of 348m. This is followed by the entrance of “Elbasan” Street heading towards Sauk, with a queue length of 307m, and the entrance of “Arben Broci” Street, with a queue length of 260m. It is important to note that these values represent the maximum queue lengths observed.



**Figure 4.** Maximum Queue Length for Scenario 1

*Average Travel Time*

Figure 5 illustrates the average travel time for a vehicle from the point of entry (i.e., where the vehicle is generated) to the roundabout priority line at each entrance during the specified time interval. The average travel times are as follows: 407 seconds per vehicle at the “Elbasan” Street - city center entrance, 171 seconds per vehicle at the “Elbasan” Street - Sauk entrance, 235 seconds per vehicle at the “Arben Broci” Street entrance, and 38 seconds per vehicle at the “Faik Konica” Street entrance.

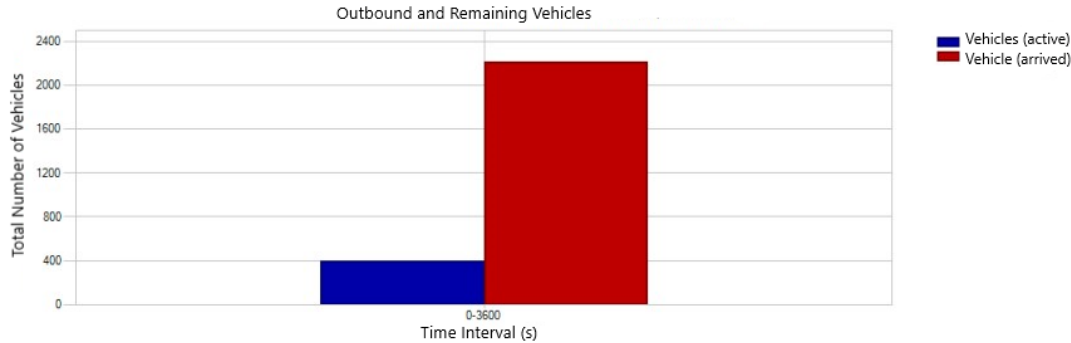


**Figure 5.** Average Travel Time for Scenario 1

*Capacity*

Figure 6 shows the total number of vehicles that have reached their destination and exited the network during the time interval (referred to as total outgoing vehicles) and the total number of vehicles remaining in the network at the end of each time interval (referred to as total remaining vehicles). This figure is particularly insightful as it provides an indication of the roundabout's maximum capacity. Calculating the capacity of a roundabout is a complex task due to the influence of numerous factors. Traffic simulation proves to be an effective tool for evaluating the capacity of a roundabout under specific conditions.

In this case, the total number of exiting vehicles represents the volume of traffic that utilized the roundabout during the specified time interval. From figure 6, it can be observed that the number of exiting vehicles stabilizes during peak times, indicating that the roundabout's capacity is being exceeded. During this interval, the roundabout reaches saturation, achieving its maximum capacity.



**Figure 6.** Capacity of Scenario 1

The maximum capacity of the roundabout is approximately 2200 vehicles per hour. At the end of the simulation, there are 400 vehicles remaining in the network. This residual number of vehicles indicates that the roundabout is operating at or near its capacity limit, causing delays and queues that extend beyond the peak period.

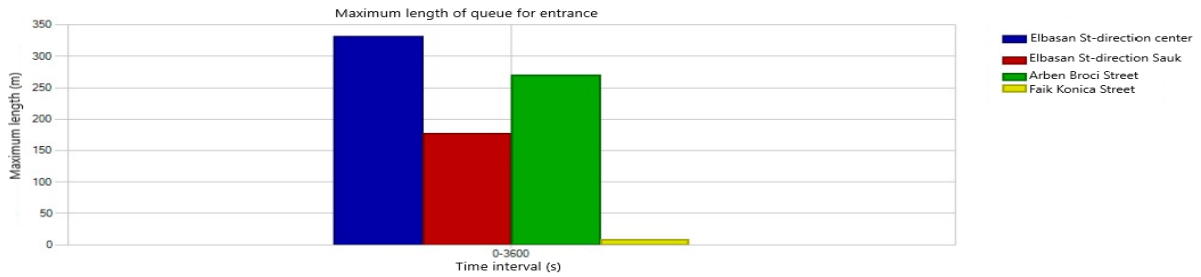
## Skenari 2

### *Maximum Queue Length*

By comparing the maximum queue length (per entry) in Scenario 2 with the maximum queue length in Scenario 1 the following findings can be highlighted. During the morning peak (approximately 08:00-09:00), the maximum queue lengths at the entrances of “Elbasan” street - center direction and “Elbasan” street - Sauk direction are significantly reduced. The main reason for the reduction of the maximum entry queue on “Elbasan” street - Sauk direction (from 30m in Scenario 1 to 177m in Scenario 2) is the change in the location of the zebra crossing. Similarly, the reduction of the maximum entry queue on “Elbasan” street - center direction (from 348m in Scenario 1 to 330m in Scenario 2) can be attributed to the alleviation of congestion upstream of the zebra crossing.

The analysis of the maximum queue length at the entrance of “Arben Broci” street and “Faik Konica” street shows that there have been no significant changes. However, it is noted that the maximum queue at the entrance to “Arben Broci” street has increased. This increase is due to the change in the location of the zebra crossing, which allows vehicles from “Elbasan” street - center direction to better utilize the gaps in traffic. Consequently, a greater flow of traffic enters from this entrance, reducing the available spaces for vehicles entering from “Arben Broci” street. Despite this, the overall effects of relocating the zebra crossing are positive.

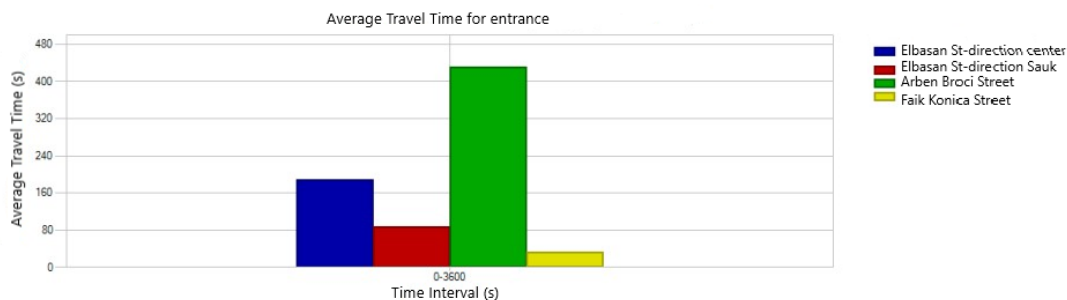




**Figure 7.** Maximum Length of Queue for Scenario 2

*Average Travel Time*

Figure 8 shows average travel time (per Entry) in Scenario 2. By comparing these results with figure 5 average travel time (per Entry) the following observations can be made. The average travel time on “Arben Broci” street increases significantly during the morning peak, from 235s/vehicle to 430s/vehicle. This increase is due to the relocated pedestrian crossing and the high number of pedestrians during the morning peak, as this period coincides with students heading to school and commuters going to work. The average travel time on “Elbasan” street - center direction is significantly reduced to an optimal value of 188s/vehicle, down from 407RRs/vehicle in the first scenario. The average travel time on “Elbasan” street - Sauk direction decreases significantly during the morning peak, from 171s/vehicle to 87s/vehicle. The average travel time on “Faik Konica” street also decreases, from 38s/vehicle to 28 s/vehicle.



**Figure 8.** Average Travel Time for Scenario 2

Queue length at roundabout entrances is directly related to the travel time taken by vehicles. Longer queues result in longer travel times. Therefore, the reasons mentioned above for the differences in maximum queue length also explain the differences in average travel time between Scenario 1 and Scenario 2.

*Capacity*

Figure 9 illustrates the total number of vehicles that have reached their destination (total outgoing vehicles) and the total number of vehicles remaining in the network. As expected, the roundabout capacity increased from 2200 vehicles per hour in the baseline scenario to 2800 vehicles per hour in the two scenario. This indicates that changing the location of the zebra crossing has increased the capacity by 23%.

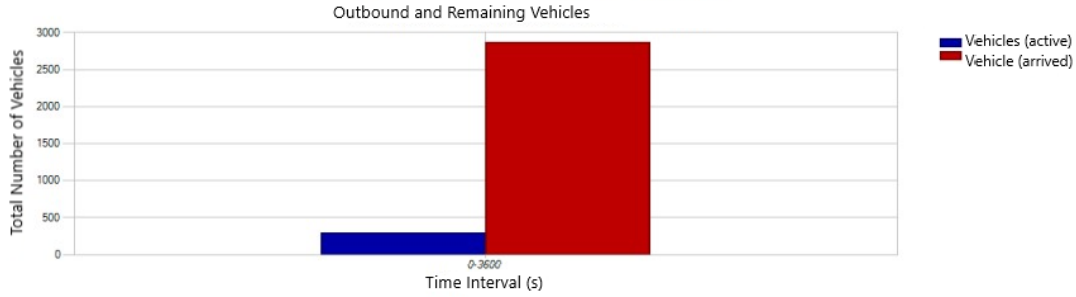


Figure 9. Capacity of Scenario 2

## DISCUSSION AND CONCLUSION

After a detailed analysis of the results obtained in this paper, the following conclusions can be highlighted regarding the effect of changing the location of the pedestrian crossing. Overall, this improvement has a very positive effect on all entrances, except the entrance on “Arben Broci” street. The improvement reduces the maximum queue length at the entrances of Elbasan Road - Center direction and “Elbasan” street - Sauk direction. It does not significantly affect the maximum queue length at the entrance of “Faik Konica” street. It increases the maximum queue length at the entrance of “Arben Broci” Street. The average maximum queue length decreases at the entrances of “Elbasan” street - center direction and “Elbasan” street - Sauk direction. It does not change significantly at the entrance of “Faik Konica” street. It increases at the entrance of “Arben Broci” street. The average travel time decreases at all roundabout entrances except for the “Arben Broci” street entrance. This pattern is also observed for the overall travel time. The capacity increases by 23%, from 2200 vehicles per hour in the baseline scenario to 2800 vehicles per hour in the new scenario. Taking into account the negative effect at the entrance of “Arben Broci” street (which is explained by the fact that this change allows vehicles from the “Elbasan” street - center direction entrance to better utilize the gaps, thus reducing the gaps available for vehicles entering from “Arben Broci” street), we conclude that changing the location of the zebra crossing has a positive effect on the overall performance of the roundabout. For future research, it is important to study the Analysis of Immediate Outputs and Inputs (Extended) and the Analysis of Control of Activated Traffic Lights from the Detectors.

## References

- Alma, A. & Shehu, E., 2016. The analysis of Performance and Capacity at a Roundabout with metering signals. *Engineering*.
- F. Alphan, et al., 1991. Roundabouts and road safety: state of the art in France.. *Intersections without Traffic Signals II*, Cilt Springer Verlag, pp. 107-125.
- Fortuijn, L. G. H., 2009. urbo Roundabouts: Design Principles and Safety Performance. *Transportation Research Record*, 2096(1), pp. 16-24.
- Gkyrtis, K., & Kokkalis, A., 2024. Gkyrtis, KoAn Overview of the Efficiency of Roundabouts: Design Aspects and Contribution toward Safer Vehicle Movement. *Vehicles*, 6(1), pp. 433-449.
- PTV Group., 2015. *PTV Vissim 7 User Manual*, Karlsruhe, Germany.
- Kimber R., T. t. c. o. r. T. R. 9., 1980. *The traffic capacity of roundabouts*, basım yeri bilinmiyor: TRRL Report 942.
- Pratelli, A., 2006. *Design of modern roundabouts in urban traffic systems*. Prague, Urban Transport XII: Urban Transport and the Environment in the 21st Century, pp. 83-93.
- Smith, E., 2022. The Future of Intelligent Transportation Systems (ITS): Applying Lessons Learned From 30 Years of Innovation.. *Public Roads-Federal Highway Administration*, Spring, pp. 12-15.

Tao, Xingyu, et al. , 2024. Towards Green Innovation in Smart Cities: Leveraging Traffic Flow Prediction with Machine Learning Algorithms for Sustainable Transportation Systems. *Sustainability*, 16(1), p. 251.

Wang, C. & al., e., 2022. Cooperative Roundabout Control Strategy for Connected and Autonomous Vehicles. 12(no. 24).

**Acknowledgment**

We would like to thank the Polytechnic University of Tirana for supporting this study.

**Conflict of Interest**

The authors have declared that there is no conflict of interest.

**Author Contributions**

Contributions of the authors to the study are equal.





**The Impact of Broadband Penetration on Economic Growth in Albania: An Empirical Analysis with data from 12 Regions, for the Period 2016-2022.**

**Teuta Xhindi<sup>\*1</sup>, Ergita Kaso<sup>2</sup>**

<sup>1</sup>European University of Tirana, Faculty of Engineering, Informatics and Architecture, Department of Informatics and Technology, Tirana 1000, Tirana, Albania

<sup>2</sup>Municipality of Gramsh, Gramsh 3301, Gramsh, Albania

\*Corresponding author e-mail:teuta.xhindi@uet.edu.al

***Abstract***

*This paper investigates the relationship between broadband penetration and economic growth in Albania, utilizing data from 12 distinct regions over the period 2016-2022. The study employs empirical analysis techniques to examine the extent to which broadband penetration influences GDP per capita. Using panel data regression models, we assess the direct effect of broadband penetration on economic growth while controlling for number of population in the regions.*

*Our findings suggest a significant positive relationship between broadband penetration and economic growth indicator in Albania. Higher levels of broadband access are associated with increased GDP per capita, across the regions studied.*

*This research contributes to the existing literature by providing empirical evidence on the role of broadband penetration in fostering economic development at a regional level in Albania. The findings underscore the potential benefits of policies aimed at expanding broadband access as a means to promote sustainable economic growth and reduce regional disparities within the country.*

**Keywords:** *Fix Broadband Penetration, Gdp Per Capita, Panel Data Regression Models, Breusch-Pagan Test, Generalized Least Square Method.*

**INTRODUCTION**

Nowadays, the term Digitalization has become synonymous with transformation, revolutionizing the way individuals, businesses, and societies operate. The integration of digital technologies into many aspects of our lives has not only accelerated the pace of change but has also emerged as a motivating force shaping the future. The World Bank estimates that the digital economy contributes to more than 15% of global gross domestic product (GDP) and in the past decade it has been growing at two and a half times faster than physical world GDP (World Economic Forum, 2022). For more, the predictions are that the digital economy will grow tremendously and contribute 30% to the global GDP and create 30 million jobs by 2030 (Digital Cooperation Organization, 2022).

As the demand for digital technology and internet-based applications grows, the need for fast and reliable electronic communication networks becomes a key factor for economic growth and the digitalization of the economy. To prepare for and accommodate this digital transition, national and European policies are encouraging the deployment of next-generation networks capable of offering Gigabit connections, both for cellular and fixed connections, through the deployment of 5G networks and optical fibers, respectively.

According to DESI 2022 report of the European Commission, since 2013, at least one broadband network has been accessible to all households within the European Union (EU), encompassing various major technologies such as xDSL, cable, fibre to the premises (FTTP), fixed wireless access (FWA), 4G, and satellite. Notably, fixed technologies predominantly provide internet access at home, boasting a stable coverage rate of 98%. Among these technologies, xDSL retains the largest footprint at 89%, followed by FWA (58%), FTTP (50%), and DOCSIS 3.0 cable (44%). The coverage of Next Generation

Access (NGA) technologies, capable of delivering download speeds of at least 30 Mbps, reached 90% in 2021, reflecting a modest increase of 2.9 percentage points compared to the preceding year. This growth primarily stemmed from a 7-point surge in FTTP coverage, while VDSL coverage remained steady and cable DOCSIS 3.0 witnessed a marginal decline of 0.8 percentage points. In 2021, Fixed Very High Capacity Networks (VHCN) extended coverage to 70% of EU households, marking a notable increase from 60% in the prior year. This augmentation was chiefly attributed to FTTP deployments. With regard to mobile technologies, while 4G coverage of populated areas has achieved near universality at 99.8%, commercial services for 5G were introduced in all Member States except Latvia and Portugal by mid-2021. The coverage of 5G expanded substantially from 14% in 2020 to encompass 66% of populated areas by 2021 (DESI, 2022). Broadband coverage in rural areas remains a persistent challenge, with 8.5% of households lacking coverage by any fixed network, and 32.5% not served by any Next Generation Access (NGA) technology. However, 4G availability is widespread in rural areas, reaching 99.6%. Notably, there has been a significant improvement in the rural coverage of FTTP via fixed technologies, with coverage increasing from 26% in 2010 to 34% by 2021 (DESI, 2022).

Albanian national objectives and policies for broadband development are in line with those of the European Union. On one hand, the Albanian government adopted on June 3, 2020, the National Plan for Sustainable Development of Digital Infrastructure, Broadband 2020-2025, with an objective to develop a high-speed digital infrastructure and ultra-fast network nationwide to establish the foundation for a gigabit society. Secondly, the adoption of Law No. 120/2016 "On the development of high-speed electronic communications networks and ensuring the right of way" aims to facilitate the construction of high-capacity networks, including the physical infrastructure of utility service providers.

The development of ICT and broadband networks increase efficiency, productivity and potentially contributes to job creation and welfare. According to OECD's Report "Broadband and the Economy" (OECD, 2008), broadband facilitates the development of new inventions, new and improved goods and services, new processes, new business models, and it increases competitiveness and flexibility in the economy. Research has shown that areas with better access to high-speed internet, experience more growth and prosperity.

This paper aims to study the relationship between broadband networks and the GDP growth in Albania, in order to measure the effect of fix broadband penetration on the Albanian economy.

## **LITERATURE REVIEW**

Several studies have examined the economic impact of broadband networks and in general from the use of ICTs.

In the research study "The economic contribution of broadband, digitization and ICT regulation", (ITU, 2018), experts have reported that in countries with low broadband penetration (under 20 per cent), an increase of 1 per cent in broadband adoption contributed to 0.008 per cent of GDP growth, while in countries with medium penetration (between 20 per cent and 30 per cent), the effect is of 0.014 per cent and in countries with penetration higher than 30 per cent, the impact of 1 per cent adoption reaches 0.023 per cent of GDP growth .

In the study conducted by Qiang et al. (2009), was found that a 10 percentage point increase in fixed broadband penetration would increase GDP growth by 1.21% in developed economies and 1.38% in developing ones. However, while the coefficient was significant at the 1 percent level for developed economies the significance was only 10% for developing economies.

The same model is used by Scott (2012), but with data for 86 countries for 1980–2011. The results were essentially the same as before with a ten percentage point increase in fixed broadband generating a 1.35% increase in per capita GDP for developing countries and a 1.19% increase for developed countries.

Ghosh (2016), has found a positive effect of broadband penetration on economic growth, primarily working through a reduction in broadband prices and well as greater innovation and entrepreneurial activity.

Kabaklarli and Atasoy (2019), by employing the dynamic GMM estimator between the years 2001-2016 for selected countries, found the positive relationship between the broadband infrastructure and economic growth for these countries. The results indicate that the number of internet users also promotes GDP per capita. So, they suggest the investments to broadband infrastructure with an aim to provide high quality, accessible and affordable telecommunication.

According to Katz et al. (2008), a CHF 13.2 billion investment in Switzerland's nationwide optical fiber network, created over 114,000 jobs and generated CHF 9.843 in value-added. Similarly, Liebenau et al. (2009) estimated that a USD 7.5 billion investment needed to achieve the target of the Digital Britain plan could have a positive impact on GDP and employment. Another example is Germany's National Broadband Strategy from Katz et al. (2010), where a total investment of close to 36 billion euros would generate a total of 968,000 incremental jobs and in 170.9 billion euros of additional GDP (0.60% GDP growth).

Lehr et al. (2014) conclude that broadband positively affects economic activity, presenting estimates of the effect of broadband on a number of indicators of economic activity, including employment, wages, and industry mix, using a cross-sectional panel data set of communities (by zip code) across the United States.

With numerous examples showcasing the benefits of investing in broadband infrastructure, it is evident that this sector should be given high priority, aiming to create jobs and economic growth.

## **DESCRIPTION OF FIXED BROADBAND DEVELOPMENTS IN ALBANIA**

### **The data about the use of internet in Albania compare to the world's population**

Based on the ITU publication "Measuring Digital Development Facts and Figures 2023", results that 67% of the world's population, or 5.4 billion people are online, indicating a growth of 4.7% since 2022, with approximately 280 million new Internet users added in 2023. Mobile broadband subscriptions have grown at a faster rate than fixed-telephone subscriptions, but access to fixed connections is unequal across countries. While 5G coverage has increased to 40% of the world population, distribution remains uneven, 89% of people in high-income countries have access to 5G, while only 1% of the population in low-income countries is covered. The coverage gap for mobile broadband remains a challenge, with only 95% of the world's population having access to a mobile broadband network (ITU, 2023).

Meantime, based on the results of the Information Technology Usage Survey (TIK) during the year 2023, among the age group 16 - 74 years old, 83.1% of the population use the internet, of which 96.2% use it multiple times a day. 99.8% of individuals have used mobile phones / smartphones to access the internet. Meanwhile, 28.2% of the population use the internet through a laptop, 27.4% through a desktop computer, and 19.1% through a tablet. 98.7% engage in calls / video calls (via Skype, Viber, WhatsApp), and this indicator has increased by 0.2 percentage points compared to 2022.

The percentage of Albanian families with internet access is 96.7%, compared to 96.5% on the previous year. 90.4% or 660,136 families have internet access through fixed broadband networks (optical or cable network, ADSL, etc.), an indicator that has increased by approximately 0.1 percentage points. The percentage of families with internet access via mobile broadband connections (3G/4G, tablets, etc.) is 99.3%, compared to 99.2% in 2022.

The activities carried out via the internet in the "last three months" from the moment of conducting the interview, which have recorded the highest increases, are: accessing health data online (e-Albania health section) (18.3 percentage points), internet banking (e-banking) (5.0 percentage points), as well as communicating through written messages (WhatsApp, etc.) (2.8 percentage points).



**Main developments in the fixed broadband market in Albania.**

The wholesale market for fixed broadband access in Albania witnessed a significant increase in the volume of lines sold since the last market analysis conducted by AKEP in 2016. The total number of lines doubled (+122%), reaching over 585 thousand active connections by the end of 2022, compared to around 264 thousand connections in 2016.

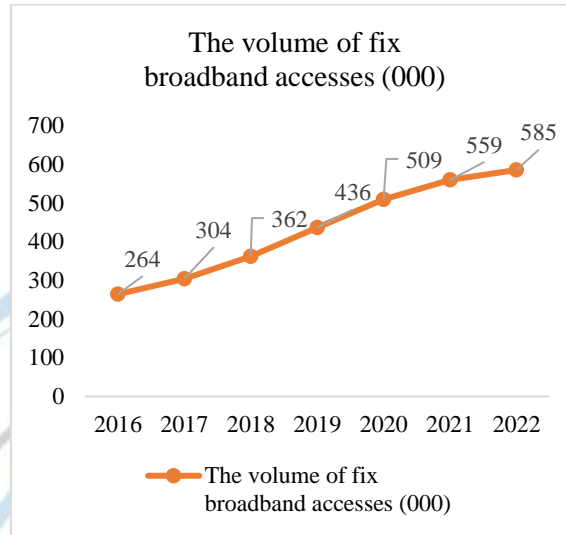


Figure 1. The number of lines sold from 2016-2022

Source: The document for public consultation, AKEP, 2024

<https://akep.al/wp-content/uploads/2024/01/Dokumenti-per-keshillim-publik-Analiza-e-tregjeve-me-shumice-te-aksesit-ne-broadband-3.pdf>

This increase in broadband connections is accompanied by a growth in the national penetration rate, which reached 81% of households in 2022, up from 37% in 2016. Furthermore, Albania improved its position compared to other countries as its penetration rate in 2021 surpassed many Eastern European countries, having lagged behind them in 2016.

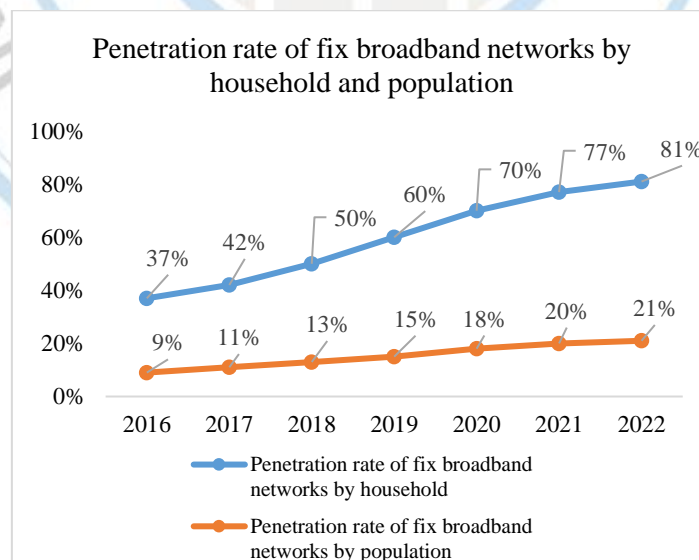


Figure 2. Penetration rate of fix broadband networks by household and population

Source: The document for public consultation, AKEP, 2024

<https://akep.al/wp-content/uploads/2024/01/Dokumenti-per-keshillim-publik-Analiza-e-tregjeve-me-shumice-te-aksesit-ne-broadband-3.pdf>

However, this increase in the national penetration rate masks a significant digital divide that persists across the territory. On one hand, the average penetration rate in urban areas remains much higher than in rural areas. On the other hand, within urban areas, the penetration rate in densely populated regions (especially in Tirana) remains significantly higher than in other less populated regions.

Regarding technology, the main observed trend is the increase in the share of fiber-based connections, which grew from just 11% in 2016 to become the primary access technology with over 61% of the market in 2022. This growth is primarily due to the overall market development (increased penetration rate, etc.), the establishment of full-fiber networks by alternative operators, and the migration from older technologies (especially copper) towards fiber.

This transition towards fiber, which is expected to continue in the coming years, has led to the availability of broadband access with faster speeds and better quality. In 2022, the share of fast and ultra-fast broadband connections (meaning download speeds of 30 Mbps or higher) represented 51% of the total access offered in the market, compared to just 1% in 2016.

According to the latest market report of AKEP, for the second quarter of 2023, following the integration of "HomeNet" subscriptions of One Albania with the fixed connections of the operator, One Albania is the market leader with 22% market share, just 0.5% higher than its closest competitor, Vodafone.

## **MATERIAL AND METHODS**

### **Material**

#### **Research question**

Research question: Does the increase of fix broadband penetration impact the economic growth in Albania?

#### **Variables description and data source**

Dependent variable: GDP per capita (000 ALL) - describes the gross domestic product (GDP) per capita in thousands of Albanian Lek (ALL), across different regions. This metric provides insight into the average economic output per person in each region. The data about this variable annually and are obtained from the Albanian Institute of Statistics website, for the period 2016-2022.

Independent variables: Independent variable 1: Population by regions - refers to the demographic distribution of people across different regions. This data typically provides information on the number of individuals residing in each region, allowing for analysis of population density, migration patterns, and regional disparities in terms of population size. Albania has undertaken two decentralization reforms in separate times in the post-communist period. The first was in the late 1990s and the second with the territorial reform of 2014. In accordance with Law 115/2015, the Albanian government consolidated 373 local authorities (municipalities and communes) into 61 municipalities and 12 regions in 2015. The data about population by regions are taken from the Albanian Institute of Statistics website, for the period 2016-2022.

Independent variable 2: Fixed broadband penetration by regions

Definition: The European Commission defines broadband as a digital infrastructure that provides constant, high-speed internet access that is faster than dial-up. However, this definition doesn't refer to a particular technology used for internet access. The Commission has defined three categories of download speeds: 'basic broadband' for speeds between 144 Kbps and 30 Mbps, 'fast broadband' for speeds between 30 and 100 Mbps, and 'ultra-fast broadband' for speeds exceeding 100 Mbps. The European Commission aims to create sustainable economic and social relationships through a Digital Single Market with the help of high-speed internet and compatible applications. The Commission has set the target speed at 1 gigabit in its Connectivity for a European Gigabit Society agenda.

Fixed broadband penetration by regions in % - refers to the percentage of households in each region that have access to fixed broadband internet services. This metric provides insight into the level of adoption and availability of broadband infrastructure in different geographical areas or administrative divisions within a country. It helps assess the digital connectivity and access to high-speed internet services across various regions, aiding policymakers and stakeholders in addressing disparities and promoting equitable access to broadband technology. The data about fixed broadband penetration by regions, are obtained from The Electronic and Postal Communications Authority institution at the request of the authors. The data are annually and in percentage points.

## Methods

This study employed panel data analysis for 12 regions from 2016 to 2022, for 3 variables, in total 252 data.

Firstly, the data about GDP per capita by regions and Population by regions are transformed in logarithmic form to improve their distribution and to avoid the effect of outliers. The table 1 below presents some statistics about variables taken in consideration.

Table 1. Some statistics about variables included in the study

	Ln(GDP per capita by regions) (000 ALL)	Ln(Population by regions)	Fixed broadband penetration by regions
Mean	6.183346	12.11786	0.122765
Median	6.138171	12.16082	0.116161
Maximum	6.786717	13.7316	0.294224
Minimum	5.758113	10.92013	0.027972
Std. Dev.	0.22616	0.684774	0.056763
Skewness	0.672809	0.537691	0.574331
Kurtosis	2.760584	3.289988	3.217255
Jarque-Bera	6.538023	4.341882	4.783184
Probability	0.038044	0.11407	0.091484
Sum	519.401	1017.9	10.3123
Sum Sq. Dev.	4.245302	38.92003	0.267431
Observations	84	84	84

The mean and median values are between the minimum and maximum values and Probability J-B values ensure the normal distribution for two out of three variables.

To empirically analyze the effect of fix broadband penetration in economic growth, are compared three models: (1) Pooled least squares; (2) Fix effects and (3) Random effects.

## RESULTS

### Pooled OLS model

In this model are not considered time and individual dimensions and Ordinary Least Square (OLS) approach is used to estimate the panel data model.

The model is:

$$Y_{it} = \beta_1 + \beta_2 X_{1it} + \beta_3 X_{2it} + \varepsilon_{it} \quad (1)$$

For  $i = 1, 2, \dots, 12$  and  $t = 2016, 2017, \dots, 2022$ .



**V. INTERNATIONAL APPLIED STATISTICS CONGRESS (UYIK - 2024)**  
**İstanbul / Türkiye, May 21-23, 2024**

The tables 2 and 3 present the estimates of parameters of model (1) and some diagnostic tests.

Table 2. The estimates of parameters of Pooled OLS model

Variable	Coefficients	S.E	t-statistic	p value
c	4.766779	0.338611	14.07744	0.000
lnPopulation by regions	0.095785	0.029435	3.254091	0.002
Fixed broadband penetration by regions	2.084154	0.355097	5.86926	0.000

Table 3. Some statistics and the results of some diagnostic tests

Diagnostic test	Statistics	p-value	Result
J-B Normality	4.48	0.11	The errors are normally distributed
Breusch-Pagan LM for correlation in residuals	49.91	0.9299	The errors are independent
Pesaran scaled LM for correlation in residuals	-1.4	0.1613	
Pesaran CD	-1.48	0.1392	
LR for homoscedasticity	12.94	0.3734	The errors are homoscedastic
Adjusted R-Square		0.49	The independent variables explain about 50% of variability of dependent variable
Prob(F-statistic)		0.000	The model is statistically significant

From table 2, we conclude that both independent variables are statistically significant and when fixed broadband penetration rate is increased with 1% then GDP per capita is increased by 2.08% in case of c.p.

### Fixed effect model

Fixed effect model consider cross sectional specific characteristic that impact the dependent variable and differences between individuals (cross sectional) can be accommodated by allowing for different intercepts for each cross sectional unit.

The Fixed effect model is:

$$Y_{it} = \beta_1 + \beta_2 X_{1it} + \beta_3 X_{2it} + \mu_i + \varepsilon_{it}$$

Theoretically, to estimate the model can be used four techniques: least squares dummy variable technique or within transformation or between transformation or first difference transformation. The table 4 presents the estimates of parameters of fixed effect model using Eviews 12.

Table 4. The estimates of parameters of fixed effect model

Variable	Coefficients	S.E	t-statistic	p value
c	5.213736	0.384746	13.55112	0.000
lnPopulation by regions	0.047897	0.035432	1.351789	0.181
Fixed broadband penetration by regions	3.170315	0.58989	5.374413	0.000

To choose between pooled OLS model and fixed effect model, we use Breusch-Pagan test. As the p value of chi-square test statistic is 0.2217, we conclude that the Pooled OLS is better than Fixed effect model.

**Random effect model**

The random effect model is:

$$Y_{it} = \beta_1 + \beta_2 X_{1it} + \beta_3 X_{2it} + v_{it}, \quad \text{where } v_{it} = u_i + \varepsilon_{it}$$

The cross sectional error term  $u_i$ , has the below characteristic:

- Has zero mean
- Is independent from  $v_{it}$
- Has constant variance
- Is independent from the explanatory variables

To estimate the random effect model, is used Generalized Least Square procedure and table 5 presents the estimates of parameters of random effect model while table 6 presents the results of some diagnostic tests for random effect model.

Table 5. The estimates of parameters of random effect model

Variable	Coefficients	S.E	t-statistic	p value
c	4.766779	0.334709	14.24158	0.000
lnPopulation by regions	0.095785	0.029096	3.292033	0.002
Fixed broadband penetration by regions	2.084154	0.351004	5.937694	0.000

Table 6. Some statistics and the results of some diagnostic tests for random effect model

Diagnostic test	Statistics	p-value	Result
J-B Normality	4.48	0.11	The errors are normally distributed
Breusch-Pagan LM for correlation in residuals	49.91	0.9299	The errors are independent
Pesaran scaled LM for correlation in residuals	-1.4	0.1613	
Pesaran CD	-1.48	0.1392	
Adjusted R-Square		0.49	The independent variables explain about 50% of variability of dependent variable
Prob(F-statistic)		0.000	The model is statistically significant

The estimates from random effect model are the same with those obtained from pooled OLS model (slight differences are in S.E and t statistic values). So, we can use one of two models to give answer our research question.

**DISCUSSION AND CONCLUSION**

This article examined the relationship between GDP per capita by regions and fixed broadband penetration rate in the Albanian context for the 2016-2022 period by using panel estimation techniques. The results indicate that Fixed broadband penetration by regions has a positive impact on GDP per capita by regions, specifically: when fixed broadband penetration rate is increased with 1% then GDP per

capita is increased by 2.08% in case of c.p.

Considering our results, we suggest that the telecommunication companies should invest more in infrastructure in some regions, especially in rural countries where the level of broadband penetration is very low, creating the conditions for greater economic growth in these areas.

In addition, in preparation for the challenges posed by digitalization, governments and institutions must prioritize the development of human resources through comprehensive strategies that address both current and future needs. Firstly, investing in education and vocational training programs tailored to digital skills is essential. This could involve integrating coding, data analysis, and digital literacy courses into school curricula and offering specialized training programs for adults. Additionally, fostering partnerships between educational institutions, industry stakeholders, and technology firms can ensure that training programs are relevant and up-to-date with rapidly evolving technological trends.

Governments can also play a crucial role in incentivizing lifelong learning and upskilling initiatives, providing subsidies or tax incentives for individuals and companies investing in digital education. Furthermore, creating supportive regulatory frameworks that encourage innovation while safeguarding workers' rights in the digital economy is paramount. This may include policies promoting job flexibility, income security, and access to affordable healthcare and social protection schemes. Ultimately, a collaborative effort between governments, institutions, and private sector stakeholders is needed to empower individuals with the necessary skills and support systems to thrive in the digital age.

### Limitations

This article considered only the effect of fix broadband penetration rate on economic growth as studies show that the impact of broadband on growth is more significant than mobile penetration. Also, not considering the investments in infrastructure or equipment may limit the research results.

### References

- AKEP, 2024. The document for public consultation. Access address: <https://akep.al/wp-content/uploads/2024/01/Dokumenti-per-keshillim-publik-Analiza-e-tregjeve-me-shumice-te-aksesit-ne-broadband-3.pdf>; Date of access: 03/02/2024.
- Broadband and Economy Report, OECD 2008. Access address: <https://www.oecd-ilibrary.org/docserver/230450810820.pdf?expires=1712160882&id=id&acname=guest&checksum=207D10EF7532B7CA7B50FC7C940BBE4C>; Date of access: 03/11/2023.
- Data Reportal, Digital 2023: Albania. Access address: <https://datareportal.com/reports/digital-2023-albania>; Date of access: 14/01/2024.
- Digital Cooperation Organization, 2022. Access address: <https://www.edgemiddleeast.com/business/dco-2030-digital-economy-to-contribute-30-of-global-gdp-and-create-30-million-jobs-by-2030#:~:text=According%20to%20the%20World%20Bank,GDP%20of%20the%20physical%20world>; Date of access: 23/11/2023.
- European Commission, 2023. The Digital Economy and Society Index (DESI). Access address: <https://digital-strategy.ec.europa.eu/en/policies/desi>; Date of access: 19/11/2023.
- European Union, Regulatory framework for electronic communications. Access address: <https://eur-lex.europa.eu/legal-content/EN/TXT/HTML/?uri=LEGISSUM:l24216a>; Date of access: 21/01/2024.
- Ghosh S, 2016. Broadband penetration and economic growth: Do policies matter? *Telematics and Informatics*, 34(5):676-693.
- International Telecommunication Union, Facts and figures 2023. Access address: <https://www.itu.int/itu-d/reports/statistics/2023/10/10/ff23-internet-use/>; Date of access:
- Instat, 2023. Information Technology Usage Survey. Access address: [https://www.instat.gov.al/media/12854/ict-2023\\_shqip.pdf](https://www.instat.gov.al/media/12854/ict-2023_shqip.pdf); Date of access: 01/02/2024.
- ITU, 2017. The state of broadband 2017: Broadband catalyzing sustainable development. Access address: [https://www.itu.int/dms\\_pub/itu-s/opb/pol/S-POL-BROADBAND.18-2017-PDF-E.pdf](https://www.itu.int/dms_pub/itu-s/opb/pol/S-POL-BROADBAND.18-2017-PDF-E.pdf); Date of access: 02/11/2023.



- ITU, Data Hub 2023. Access address: <https://datahub.itu.int/data/?e=ALB&c=701&i=19303>; Date of access:10/01/2024.
- ITU, 2023. Measuring Digital Development – Facts and Figures 2023. Access address: <https://www.itu.int/en/ITU-D/Statistics/Pages/facts/default.aspx>; Date of access:10/01/2024.
- Kabaklarlı E, Atasoy S.B, 2019. Broadband infrastructure and economic growth: A panel data approach for selected countries. DIEM: Dubrovnik International Economic Meeting, 4(1):105- 114.
- Katz R.L., Zenhäusern P, and Suter S, 2008. An Evaluation of Socio-Economic Impact of a Fiber Network in Switzerland. Polynomics and Telecom Advisory Services, LLC, New York.
- Katz R. L, Suter S, Vaterlaus S, Zenhäusern P, 2010. The Impact of Broadband on Jobs and the German Economy. *Intereconomics*, 45 (1): 26-34.
- Lehr W, Osorio A.C, Gillett Sh, Sirbu M, 2014. Measuring Broadband's Economic Impact. 33rd Research Conference on Communication, Information, and Internet Policy (TPRC), 23-25 September 2005, Arlington, VA.
- Leskaj E, Lazimi L, 2023. The Telecommunications Industry and Its Impact on the Albanian Economy. *EIRP Proceedings*, 18(1): 292-301
- Liebenau J, Atkinson R. D, Kärrberg P, Castro D, Ezell S, 2009. *The UK's digital road to recovery*. LSE Enterprise Ltd. & The Information Technology and Innovation Foundation, London, UK.
- Qiang C. Z, Rossotto C. M, Kimura K, 2009. Economic Impacts of Broadband. In *Information and Communications for Development 2009: Extending Reach and Increasing Impact*, Washington DC: World Bank, Chapter 3:35-51.
- Scott C, 2012. Does Broadband Internet Access Actually Spur Economic Growth? Published on ELDIS database on January 2012. Access address: <http://www.eecs.berkeley.edu/~rsc/classes/ictd.pdf>; Date of access:12/02/2024.
- The State of Broadband: Broadband as a Foundation for Sustainable Development, 2019. Access address: <http://handle.itu.int/11.1002/pub/813c98f4-en>; Date of access:05/11/2023.
- World Economic Forum, 2022. Access address: <https://www.weforum.org/agenda/2022/08/digital-trust-how-to-unleash-the-trillion-dollar-opportunity-for-our-global-economy/#:~:text=The%20World%20Bank%20estimates%20that,faster%20than%20physical%20world%20GDP>; Date of access: 05/11/2023.

#### **Conflict of Interest**

The authors have declared that there is no conflict of interest.

#### **Author Contributions**

After conducting a careful review of the existing literature, using the data from 12 regions over the period 2016-2022, the authors found that when fixed broadband penetration rate is increased with 1% then GDP per capita is increased by 2.08% in case of c.p. Based on this result, telecommunication companies are encouraged to increase their investments, particularly in rural areas aiming to foster economic growth and development. Furthermore, we recommend that the local governments and institutions must prioritize the development of human resources through comprehensive strategies that address both current and future needs. This includes a crucial emphasis on investing in education and vocational training programs specifically designed to enhance digital skills.

## Konut Satış Tahminlerinin Coğrafi Bilgi Sistemi Tabanlı Analizi: İstanbul İli Örneği

**Duygu Atasever<sup>1\*</sup>, Ersoy Öz<sup>1</sup>**

<sup>1</sup>Yıldız Teknik Üniversitesi, Fen Edebiyat Fakültesi, İstatistik Bölümü, 34000, İstanbul, Türkiye

\*Sorumlu yazar e-mail: duygu.atasever@std.yildiz.edu.tr

### Özet

Konut piyasası, konutların birbirinden farklı özelliklere sahip olmaları nedeniyle heterojen ürünlerden oluşan bir piyasadır. Bu yüzden konut fiyatlarının tahmini, hem bireyler hem de sektör profesyonelleri için önemli bir konudur. Özellikle İstanbul gibi büyük ve dinamik bir şehirde, fiyatların nasıl şekillendiğini anlamak, doğru yatırım kararları alabilmek için kritik bir öneme sahiptir. Bu bağlamda, gelişmiş analitik yöntemler ve teknolojilerin kullanımı, konut fiyat tahminlerinin doğruluğunu artırmada büyük bir rol oynar. Coğrafi Bilgi Sistemleri (CBS) ve makine öğrenmesi tekniklerinin entegrasyonu, bu alanda yeni ve etkili bir yaklaşım sunmaktadır. Bu yöntemler, konut fiyatlarını etkileyen çeşitli faktörlerin, özellikle de konumsal faktörlerin, derinlemesine analiz edilmesini sağlar. İstanbul ilindeki konut fiyatlarını tahmin etmeye ve bu fiyatların coğrafi dağılımını CBS ile analiz etmeye yönelik bu araştırma, makine öğrenmesi algoritmaları kullanarak konut özelliklerinin yanı sıra konumsal faktörleri de dikkate alarak fiyat tahminlerinde bulunur. Uygulama kısmında, 39.525 adet konut verisi üzerinde çalışılarak, ilan özellikleri ve coğrafi verilerle detaylı modeller oluşturulmuştur. Araştırma, denize yakınlık, alışveriş merkezleri/markete yakınlık, ulaşım kolaylığı (duraklara yakınlık) ve yeşil alanlara yakınlık gibi yeni konumsal değişkenlerin eklenmesiyle CBS'nin etkisini daha derinlemesine incelemiştir. Bu değişkenler, makine öğrenmesi modellerine entegre edilerek, konut fiyatları üzerindeki etkileri ölçülmüştür. Çalışmada, konut fiyatlarının İstanbul'daki dağılımını gösteren detaylı tematik (konusal) haritalar ile sunulmuştur. Bu haritalar, fiyat tahminleri ve pazar analizleri için değerli bir kaynak oluşturmakta, CBS ve makine öğrenmesi tekniklerinin bir arada kullanılmasının önemini vurgulamaktadır. Sonuç olarak, bu çalışma, konut piyasasının analiz edilmesi ve fiyat tahminlerinin yapılması konusunda yeni bir perspektif sunarak, sektördeki uygulamalara katkıda bulunmayı amaçlamaktadır. Bu entegre yaklaşımın, alandaki gelecek çalışmalara yön vermesi ve konut piyasasının daha detaylı analiz edilmesine olanak tanınması beklenmektedir.

**Anahtar Kelimeler:** Konut Değerleme, Coğrafi Bilgi Sistemleri, Makine Öğrenmesi, İstanbul

### GİRİŞ

Günümüzde, konut piyasalarındaki dalgalanmalar ve fiyat değişimleri, hem bireysel mülkiyet sahipleri hem de gayrimenkul sektörü paydaşları için önemli bir konu haline gelmiştir. Bu değişkenlik, konut satışlarını etkileyen bir dizi faktörün karmaşıklığından kaynaklanmaktadır. İstatistik ve makine öğrenmesi, bu karmaşıklığı anlamak ve gelecekteki konut satışlarını tahmin etmek için önemli araçlar sunmaktadır. Bu çalışma, konut satışlarının tahmin edilmesi sürecinde istatistik ve makine öğrenmesi tekniklerinin yanı sıra coğrafi bilgi sistemi (CBS) tabanlı analizlerin önemini vurgulamaktadır.

Makine öğrenmesi, büyük ve karmaşık veri kümelerinin analiz edilerek içlerindeki desenlerin ve ilişkilerin keşfedilmesinde kritik bir rol oynar. Makine öğrenmesi yöntemleri finans, yatırım, gayrimenkul değerlendirme gibi çeşitli ekonomik alanlarda yaygın olarak kullanılmaktadır (Mete ve Yomralıoğlu, 2022). Bu yöntemler, konut piyasasındaki dinamiklerin daha iyi anlaşılmasını sağlayarak, konut fiyatlarını etkileyen çeşitli faktörleri tanımlamak ve gelecekteki satışları daha doğru bir şekilde tahmin etmek amacıyla kullanılmaktadır.

Çalışmanın bir diğer önemli boyutu ise CBS tabanlı analizlerdir. CBS, konum verilerini haritalama ve analiz etme yeteneği ile öne çıkar. Konut satışlarındaki eğilimlerin ve kümelenmelerin tespit edilebilmesi, fiyat değişikliklerinin ve talep artışının coğrafi faktörlerle ilişkilendirilmesi ve sonuçların görsel olarak sunulup karar alıcılara daha kapsamlı bir bakış açısı sunmak için CBS etkin bir platform oluşturmaktadır (Yalçın, 2020).

CBS analizleri, konut satış tahminlerine coğrafi bir boyut kazandırarak, konumun konut fiyatları üzerindeki etkisini detaylı bir şekilde incelemeyi amaçlar. Böylece, konut satış fiyatlarının sadece ekonomik ve sosyal faktörlerle değil, aynı zamanda coğrafi konumla da nasıl şekillendiğini ortaya koymayı hedefler. Bu çok boyutlu yaklaşım, konut piyasası analizlerinde daha kapsamlı ve derinlemesine bir anlayış geliştirmek için önemli bir adımdır. Makine öğrenmesi modelleri ve CBS tabanlı analizlerin entegrasyonu, konut satışları üzerine yapılan tahminlerin doğruluğunu ve güvenilirliğini artırarak, karar vericilere, yatırımcılara değerli içgörüler sunmayı amaçlamaktadır.

Bu çalışma, makine öğrenmesi modelleriyle yapılan konut satış tahminlerinin yanı sıra, CBS tekniklerinin kullanılarak oluşturulan tematik (konusal) haritaların sunduğu coğrafi veri analizleri, konut piyasasındaki etkileşimleri daha derinlemesine anlamamıza olanak tanıyacaktır. Analizler, konut fiyatlarının coğrafi konumlarına göre nasıl değiştiğini, belirli bölgelerdeki talep artışını ve konut piyasasındaki diğer dinamikleri ortaya çıkaracaktır.

### **Literatür**

Çalışmanın bu bölümü hem ulusal hem de uluslararası alanda yapılmış çeşitli çalışmaları inceleyerek, konut fiyatları üzerindeki mekânsal özelliklerin etkisini ve gayrimenkul değerlendirme için kullanılan metodolojileri ele almaktadır. Bu çalışmalar kronolojik sıraya göre aşağıda kısaca özetlenmiştir.

Niğde kenti için gerçekleştirilen çalışmada taşınmazların değerlendirmesi için çok ölçütlü karar verme (ÇKKV) yöntemlerinden biri olan Analitik Hiyerarşi Süreci (AHP) ve CBS kullanılarak bir değerlendirme modeli geliştirilmiştir. Bu model sayesinde, taşınmazların piyasa değerleri ile AHP ve CBS yardımıyla belirlenen değerlerin karşılaştırılması yapılmıştır. Taşınmaz değerlendirmesinde beş ana kriter (yapı özellikleri, konum, altyapı, ulaşım, nüfus) ve bu kriterlere bağlı 38 alt kriter dikkate alınmıştır. Bu kriterler, taşınmaz değerlendirmesinde önem dereceleri uzman görüşleriyle belirlenerek ağırlıklandırılmıştır. Sonuç olarak, Niğde kentinde seçilen 30 dairenin AHP ve CBS yöntemleri kullanılarak yapılan değerlendirme, taşınmazların piyasa değerleri ile uyumlu olduğunu göstermiştir. Bu yaklaşım, taşınmaz değerlendirmesinde objektif ve güvenilir bir yöntem olarak önerilmektedir (Bozdağ ve Ertunç, 2020)

Chao Xue ve diğerleri 2020 yılında Çin'deki konut fiyatlarının tahmin modelini oluşturmak için CBS teknolojisi ve taşıma erişilebilirliğini kullanarak yapılan bir çalışma gerçekleştirdiler. Bu araştırma, yaya, otobüs ve metro erişilebilirliği olmak üzere üç kentsel toplu taşıma endeksi oluşturur ve rastgele orman (random forest, RF), Gradient Boosting Decision Tree (GBDT), Light Gradient Boosting Machine (LGBM) algoritmalarını kullanarak konut fiyatlarını tahmin etmek için bir model geliştirir. Araştırmanın bulguları, taşıma erişilebilirliğinin, farklı kentsel alanlardaki toplu taşımanın kolaylığını temsil ettiğini ve kentsel toplu taşımanın erişilebilirliğinin kentsel konut fiyatları üzerinde önemli bir etkisi olduğunu gösterir. Model, %89,2 tahmin doğruluğu ve 1761,84 kök ortalama kare hatası (RMSE) ile yüksek bir tahmin başarısı sergiler. Bu çalışma, taşıma erişilebilirliğinin kentsel konut ekonomisi üzerindeki rolüne ve toplu taşıma gelişiminin konut ekonomisinde nasıl önemli bir faktör olduğuna dair anlayışı derinleştirir (Xue ve diğerleri, 2020).

Bir başka çalışmada, CBS ve makine öğrenmesi yöntemlerinin entegrasyonu ile konut amaçlı taşınmazların toplu değerlendirilmesine odaklanmaktadır. Türkiye ve Birleşik Krallık'taki konutların toplu değerlendirilmesi için geliştirilen hibrit bir yaklaşım sunulmaktadır. Açık lisanslı coğrafi veri kaynakları kullanılarak yapılan yakınlık, yüzey ve görünürlük analizleri sonucunda bir taşınmaz değer haritası oluşturulmuştur. XGBoost, CatBoost, LightGBM ve RF gibi algoritmalar kullanılarak fiyat tahmin modelleri geliştirilmiştir. Konumsal kriterler, değerlendirme verilerine öznitelik zenginleştirme amacıyla dahil edilmiş ve tahmin doğruluğu önemli derecede artırılmıştır. RF modeli, diğer regresyon yöntemlerine göre daha yüksek bir doğruluğa ulaşmıştır. Bu çalışma, taşınmaz değerlendirme alanında CBS ve makine öğrenmesi yöntemlerinin potansiyelini vurgulamakta ve önerilen hibrit yaklaşımın diğer bölgelerde de uygulanabileceğini öngörmektedir (Mete ve Yomralıoğlu, 2022).



Gerçekleştirilen başka bir çalışmada, İstanbul'daki konut fiyatlarını tahmin etmek için Hedonik Fiyat Modeli (HPM) ve YSA yöntemlerini karşılaştırarak, Eylül 2015 ile Nisan 2019 arasında satılan 900 konut üzerinden bir analiz sunar. Araştırma, YSA modelinin HPM'ye göre konut fiyatlarını daha başarılı bir şekilde tahmin ettiğini ve düşük ortalama mutlak hata (MAE) değerleriyle daha doğru sonuçlar sağladığını bulmuştur. Sonuç olarak, konut fiyat tahminlerinde YSA yönteminin daha etkili olduğu gösterilmiştir (Taşabat ve Ersen, 2023).

Son olarak, coğrafi verilerin işlenmesi ve RF algoritması kullanılarak konutlar için bir değer tahmin modeli geliştirilmiştir. Konutların ekonomik değerlemesi için 120'den fazla kriter belirlenmiş, bu kriterler üzerinden coğrafi ve yapısal veriler analiz edilmiştir. Model geliştirmede pearson korelasyon analizi ve kutu grafik yaklaşımı ile aykırı veri analizi yapılmıştır. RF yöntemi ile geliştirilen model, çoklu doğrusal regresyon analizi ile karşılaştırılarak test edilmiş ve RF yönteminin daha etkin sonuçlar verdiği tespit edilmiştir. Bu bulgular, makine öğrenmesi tekniklerinin ve coğrafi bilgi sistemlerinin taşınmaz değerlendirme süreçlerinde önemli faydalar sağlayabileceğini göstermektedir (Şişman ve Aydınoglu, 2023).

## MATERYAL VE YÖNTEM

### Materyal ve Yöntem

Bu çalışma, İstanbul İli'nde 2023-2024 yılları arasında gerçekleşen 39.525 adet konut satışlarına ait verileri kapsamaktadır. Her bir kayıt için konutun büyüklüğü, oda sayısı, bina yaşı, konum koordinatları ve satış fiyatı gibi temel bilgilerin yanı sıra, çevresel ve sosyal altyapı faktörleri de kaydedilmiştir. Özellikle, konutların önemli altyapı noktalarına olan uzaklıkları (örneğin, en yakın metro istasyonu, deniz, park/yeşil alanı ve alışveriş merkezleri) CBS araçları kullanılarak hesaplanmıştır.

CBS analizleri için ArcGIS ve QGIS (*Quantum GIS*) gibi yazılımlar kullanılmıştır. Bu araçlar, konutların şehir içindeki stratejik noktalara olan uzaklıklarını ölçmek ve bu verileri analize entegre etmek için tercih edilmiştir. Ayrıca, konutların coğrafi dağılımını ve çevresel etkileşimlerini görselleştirmek için tematik haritalar oluşturulmuştur.

Veri ön işleme, özellik mühendisliği ve model optimizasyonu adımları Python ortamında gerçekleştirilmiştir. Modelleme sürecinde, Python programlama dili ve Scikit-Learn kütüphanesi kullanılarak çeşitli makine öğrenmesi algoritmaları (XGBoost, LightGBM, CatBoost) uygulanmıştır. Çalışmada iki ana model geliştirilmiştir. Birinci model, CBS olmadan temel konut özelliklerini analiz ederken, ikinci model CBS ile elde edilen verileri (ulaşım noktalarına, sahile/denize, park/yeşil alanlara ve alışveriş merkezlerine olan mesafeler) ekleyerek daha kapsamlı bir tahmin yapmayı amaçlar. Model doğrulama süreçleri için çapraz doğrulama teknikleri kullanılarak, modellerin genelleyicilik kabiliyeti ve performans metrikleri (R-kare, MAE, RMSE) değerlendirilmiştir.

## BULGULAR

Çalışmada kullanılan veri seti hakkında bilgiler ve modellerden elde edilen bulguların bir kısmı bu bölümde gösterilmiştir.

### *Verinin incelenmesi ve Veri ön işleme*

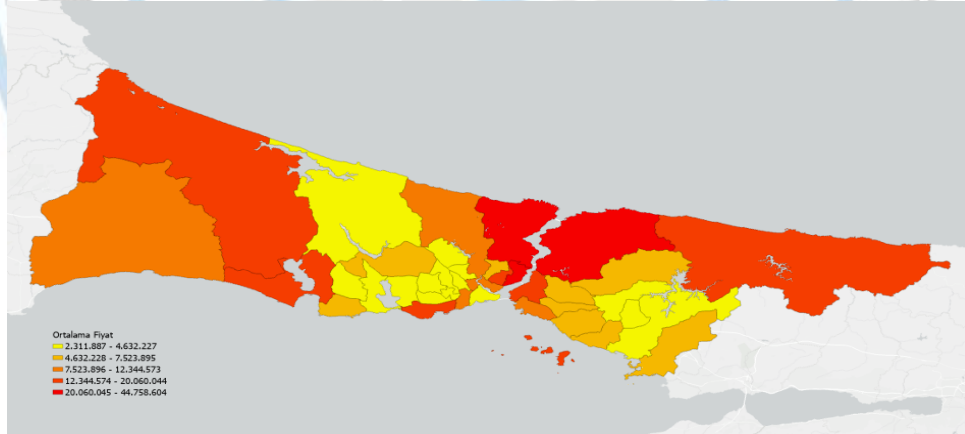
Konut piyasası dinamiklerini yansıtan çeşitli öznitelikleri içeren geniş bir veri seti incelenmiştir. Tablo 1'de görüldüğü gibi, birinci model şu özellikleri kullanmaktadır: m<sup>2</sup> (Net), Oda Sayısı, Bina Yaşı, Bulunduğu Kat, Kat Sayısı, Isıtma, Banyo Sayısı, Asansör, Otopark, Site İçerisinde, Krediye Uygun, İlçe, Mahalle, Fiyat, Enlem ve Boylam. İkinci model ise, CBS analizleri kullanılarak oluşturulmuş mesafe verileri eklenerek geliştirilmiştir; bu veriler Ulaşım Noktalarına Uzaklık, Sahile/Denize Uzaklık, Park/Yeşil Alanlara Uzaklık ve Alışveriş Merkezine Uzaklık özelliklerini içermektedir. Konutların, sahile, parklara, alışveriş merkezlerine ve ulaşım noktalarına olan uzaklıkları, piyasa dinamikleri üzerinde belirleyici bir rol oynayabileceği düşüncesiyle eklenmiştir. Bu tür değişkenler, modelin tahmin

başarısını artırmada kritik bir öneme sahiptir.

**Tablo 1.** Analizde Kullanılan Değişkenler ve Açıklamaları

Değişkenler	Açıklama	Veri Tipi
m <sup>2</sup> (Net)	Konutun net metrekaresi	Nümerik
Oda Sayısı	Konutta bulunan oda sayısı	Nümerik
Bina Yaşı	Binanın yapımından bu yana geçen süre	Nümerik
Bulunduğu Kat	Konutun bulunduğu kat	Kategorik
Kat Sayısı	Binanın toplam kat sayısı	Kategorik
Isıtma	Konutun ısıtma tipi	Kategorik
Banyo Sayısı	Konutta bulunan banyo sayısı	Nümerik
Asansör	Binada asansör bulunup bulunmadığı	Kategorik
Otopark	Konutun otopark imkânı	Kategorik
Site İçerisinde	Konutun site içerisinde olup olmadığı	Kategorik
Krediye Uygun	Konutun krediye uygunluğu	Kategorik
İlçe	Konutun bulunduğu ilçe	Kategorik
Mahalle	Konutun bulunduğu mahalle	Kategorik
Fiyat	Konutun satış fiyatı	Nümerik
Enlem, Boylam	Konutun coğrafi koordinatları	Nümerik
Ulaşım Noktalarına Uzaklık	Ulaşım noktalarına olan mesafe	Nümerik
Sahile/Denize Uzaklık	Sahil veya denize olan mesafe	Nümerik
Park/Yeşil Alan Uzaklık	Park veya yeşil alanlara olan mesafe	Nümerik
Alışveriş Merkezine Uzaklık	Alışveriş merkezlerine olan mesafe	Nümerik

Şekil 1.'de yer alan tematik haritada, veri setinden elde edilen İstanbul'un ilçe bazında ortalama konut fiyatları görselleştirilmiştir. Bu harita, CBS kullanılarak hazırlanmış olup, ilçeler arası fiyat farklılıkları ve bu farklılıkların potansiyel nedenlerini anlamak için kullanılabilir. Her ilçenin ortalama konut fiyatı renk skalası ile kodlanmıştır, burada koyu renkler daha yüksek fiyatları ifade etmektedir. Bu görsel, İstanbul'daki konut piyasası değerlerinin coğrafi dağılımını net bir şekilde sergilemektedir.



**Şekil 1.** Konutların İlçelere Göre Ortalama Fiyat Dağılımı

Haritada koyu kırmızı ile gösterilen bölgeler, 20.060.045 - 44.758.604 TL arasında değişen fiyatlarla İstanbul'un en pahalı ilçelerini temsil etmektedir. Bu ilçeler genellikle merkezi bölgelerde yer almakta veya özel ekonomik, sosyal ve kültürel altyapılara sahip olmaktadır. 2.311.887 - 4.632.227 TL aralığındaki fiyatlarla gösterilen sarı bölgeler ise şehrin daha uzak ve gelişmekte olan ilçeleridir. Bu ilçeler, merkezi bölgelere göre daha düşük konut fiyatlarına sahiptir ve genellikle ulaşım olanaklarının sınırlı olduğu, ekonomik aktivitenin daha az olduğu alanlardır.

Analiz sürecinde, veri setinin incelenmesi ve temizlenmesiyle başlanmıştır, bu aşamada eksik veya aykırılık içeren veriler, ilgili özniteliklerin doğasına uygun istatistiksel yöntemler kullanılarak giderilmiştir.

Son olarak, modelleme aşamasına geçilmeden önce, veriler uygun şekilde ölçeklendirilmiş ve dönüştürülmüştür. Sayısal verilerin standardizasyonu ve kategorik verilerin one-hot encoding yöntemi ile dönüştürülmesi, heterojen veri yapılarının algoritmalar tarafından daha etkin işlenmesini sağlamıştır. Bu dönüşümler, algoritmaların veri seti üzerinde en uygun performans göstermelerine olanak tanımıştır, böylece daha güvenilir ve doğruluk derecesi yüksek tahminler elde edilmiştir. Bu adımların sonucunda 32.908 adet veri modelde kullanılmıştır.

### **Model Seçimi ve Eğitimi**

Çalışmada, regresyon tabanlı çeşitli öğrenme algoritmaları değerlendirilmiştir; özellikle XGBoost, LightGBM ve CatBoost modelleri üzerinde durulmuştur. Bu modellerin seçilmesinde, geniş parametre ayarlama kapasiteleri ve yüksek performans potansiyelleri etkili olmuştur. Araştırma kapsamında, veri seti rastgele şekilde eğitim ve test setlerine ayrılarak, modeller belirlenen parametreler dahilinde eğitilmiştir.

Modelin tahmin performansını objektif bir biçimde değerlendirmek için, her bir model tarafından test seti üzerinde yapılan tahminler, gerçek değerlerle karşılaştırılmıştır. Performans değerlendirme metrikleri olarak, Kök Ortalama Kare Hata (RMSE) ve korelasyon katsayısı olan  $R^2$  skoru kullanılmıştır. RMSE, tahmin edilen değerlerin gerçek değerlerden ne kadar sapma gösterdiğini nicel olarak ifade ederken,  $R^2$  skoru, modelin bağımlı değişkenin varyansını ne kadar açıkladığını gösteren bir göstergedir. Bu metrikler aracılığıyla, modellerin tahmin doğruluğu ve genel performansı kapsamlı bir şekilde incelenmiştir.

Bu çalışmada iki veri setine uygulanan modeller, İstanbul ilindeki konut satış fiyatlarını tahmin etmek için kullanılmıştır. Birinci model, temel konut özelliklerini analiz ederken, ikinci model, CBS verileri ile zenginleştirilmiş bir modeldir ve stratejik konum özellikleri veri setine eklenmiştir.

#### **1. Model (Temel Model)**

Model, konutların büyüklüğü, oda sayısı, bina yaşı gibi temel özellikleri kullanarak tahminlerde bulunmuştur.

**Tablo 2. Birinci Model Sonuçları**

<b>Model</b>	<b>Title</b>
XGBoost	0.8185
LightGBM	0.8134
CatBoost	0.7751

Tablo 2' de görüldüğü gibi temel modelde kullanılan XGBoost, LightGBM ve CatBoost modelleri arasında, XGBoost en yüksek doğruluk oranına (0.8185) sahiptir. Bu, XGBoost'un karmaşık veri yapıları üzerinde iyi çalışabildiğini ve overfitting'e (aşırı uyum) karşı oldukça dayanıklı olduğunu göstermektedir. LightGBM, XGBoost'a oldukça yakın bir performans sergilemiştir (0.8134). CatBoost, diğer iki modelden biraz daha düşük performans göstermiştir (0.7751).

#### **2. Model (CBS ile Zenginleştirilmiş Model)**

Bu model, ek olarak CBS verilerini kullanarak, konutların ulaşım noktalarına (metro, otobüs, tramvay istasyonları), park ve yeşil alanlara, sahile/denize ve alışveriş merkezlerine olan mesafelerini dikkate almıştır.

**Tablo 3. İkinci Model Sonuçları**

<b>Model</b>	<b>Title</b>
XGBoost	0.8366
LightGBM	0.8241
CatBoost	0.7881



CBS verilerinin eklenmesiyle birlikte, tüm modellerin performansında bir artış görülmüştür. Bu, konut fiyat tahminlerinde ulaşım noktalarına, parklara, sahile ve alışveriş merkezlerine olan mesafenin önemli özellikler olduğunu gösterir. Özellikle, XGBoost modelinin performansı önemli ölçüde artmıştır (0.8366), bu da modelin ek özelliklerle daha iyi bilgi çıkarımı yapabildiğini işaret eder. LightGBM ve CatBoost modelleri de performans artışı göstermiş, ancak bu artış XGBoost kadar belirgin değildir. Bu durum, farklı modellerin veriye duyarlılıklarının ve özellik seçimlerinin önemini ortaya koyuyor.

Sonuçlar, ikinci modelin, CBS verileri sayesinde, tahmin başarısının önemli ölçüde arttığını göstermiştir. Özellikle konutların önemli sosyal altyapılarla olan ilişkisinin fiyat tahminlerinde belirleyici bir faktör olduğu ortaya çıkmıştır.

Her iki modelin karşılaştırılması, coğrafi verilerin ve çevresel faktörlerin konut fiyat tahminlerindeki etkisini açıkça göstermektedir. CBS verilerinin entegrasyonunun, tahminlerin doğruluğunu artırdığı ve daha güvenilir sonuçlar ürettiği kanıtlanmıştır.

## SONUÇ

Bu çalışma, CBS ve makine öğrenmesi tekniklerinin, İstanbul gibi karmaşık bir şehirde konut fiyat tahminlerini nasıl iyileştirebileceğini göstermektedir. XGBoost, LightGBM ve CatBoost algoritmalarının performanslarının karşılaştırmalı olarak değerlendirilmesiyle, modellerin konut piyasası dinamiklerini ne derece başarıyla modellediği analiz edilmiştir. Elde edilen sonuçlara göre, her bir modelin  $R^2$  skoru ve RMSE değerleri dikkate alınarak, tahmin başarısı ölçülmüştür.

Ayrıca, elde edilen bulgular, konumun ve çevresel faktörlerin, konut fiyatları üzerindeki belirleyici etkisini vurgulamaktadır. Bu durum, İstanbul gibi heterojen yapıya sahip şehirlerde, konut fiyatlarının belirlenmesinde bu tür faktörlerin ne kadar önemli olduğunu göstermektedir.

Sonuç olarak, bu araştırma, farklı makine öğrenmesi algoritmalarının konut fiyat tahminleri konusundaki uygulanabilirliklerini ve etkinliklerini değerlendirme imkânı sunmuştur. Araştırma bulguları, ilerleyen çalışmalarda model seçim sürecine yönelik bilimsel bir rehber olarak kullanılabilir ve modelleme tekniklerinin optimizasyonu için temel bir referans noktası teşkil edebilir. Bu tür analitik çalışmalar, gerçek dünya verileri üzerindeki prediktif modellerin doğruluğunu artırmada ve stratejik karar verme süreçlerini desteklemede önemli bir rol oynamaktadır. Araştırma ayrıca, bu tekniklerin şehir planlaması, yatırım kararları ve politika geliştirme süreçlerinde nasıl stratejik araçlar olarak kullanılabileceğini de ortaya koymaktadır.

## Kaynaklar

- Bozdağ, A., & Ertunç, E. (2020). CBS ve AHP Yöntemi Yardımıyla Niğde Kenti Örneğinde Taşınmaz Değerleme. *Geomatik*, 5(3), 228-240. <https://doi.org/10.29128/geomatik.648900>
- C. Xue, Y. Ju, S. Li, Q. Zhou, Q. Liu, "Research on accurate house price analysis by using gis technology and transport accessibility: A case study of xi'an, china," *Symmetry*, vol. 12, no. 8, p. 1329, 2020.
- M. O. Mete, T. Yomralıoğlu, 2022. Cbs ve makine öğrenmesi yöntemleri ile konut amaçlı taşınmazların toplu değerlemesi. TUFUAB – MERSİN 2022
- M. Yalçın, "Türkiye konut satış İstatistiklerinin cbs tabanlı analizleri," *Afyon Kocatepe Üniversitesi Fen Ve Mühendislik Bilimleri Dergisi*, vol. 20, no. 3, pp. 448–455, 2020
- S. E. Taşabat, M. Ersen, "House price prediction: A case study for İstanbul," in *Industry 4.0 and the Digital Transformation of International Business*, Springer, 2023, pp. 233–250.
- S. ŞİŞMAN, A. Ç. AYDINOĞLU, "Toplu taşınmaz değerlendirme için coğrafi verinin İşlenmesi ve rastgele orman makine öğrenmesi tekniğiyle tahmin modelinin geliştirilmesi," *Harita Dergisi*, vol. 169, pp. 13–27, 2023.

## Çıkar Çatışması

Yazarın herhangi bir çıkar çatışması yoktur.

**Prediction: Case of a Specific Region in Albania**

**Malvina Xhabafti<sup>1\*</sup>, Valentina Sinaj<sup>2</sup>**

<sup>1</sup> University of Tirana, Faculty of Economy, Department of Statistics and Applied Informatics, 1001, Tirana, Albania

\*Corresponding Author e-mail: xhabaftimalvina1@gmail.com

***Abstract***

*Drought is a phenomenon that has a fundamental impact on the economy of a country, negatively affecting a very important sector such as agriculture. Considering its importance as well as the observed changes in drought indices in recent decades, its prediction is fundamental in the planning and proper management of water resources in the economy of a country. This paper presents a forecast of droughts in a specific area of Albania, which is known for the cultivation of various crops, by analyzing monthly rainfall data for this area from January 1901 to December 2022. Considering the complexity that such phenomena have in forecasting which consists of linear and non-linear features, this study has combined the advantages of ARIMA and ANN to test a hybrid method compared to the individual methods. Firstly, each model was tested individually, i.e. ARIMA, SARIMA and ANN, evaluating their performances. Secondly, the hybridization of the models was done to see how the evaluation metrics would change for each prediction and if we would have an improvement of the forecasted model. It was concluded that the ARIMA-ANN model which ANN was modeled with the ARIMA residuals outperformed the single predictive models ARIMA, SARIMA, ANN and the hybrid SARIMA-ANN model. The metrics used for the performance evaluation were RMSE, MAPE and MSE.*  
**Keywords:** Hybrid model, Drought forecasting, ARIMA, ANN, Performance Metric

**INTRODUCTION**

Droughts, as a climatic phenomenon, are characterized by prolonged periods of significantly below-average rainfall, presenting essential challenges to a country's ecosystem and economy. Its far-reaching impacts include agricultural productivity, water availability and socio-economic stability. Predicting drought is vital for the management of water supplies, irrigated farming, environmental surveillance, and the health of ecosystems. Statistical models like ARIMA or SARIMA have been used through the years to analyze and forecast historical drought data and capture the temporal patterns and trends in drought occurrence by also identifying long-term trends in drought frequency, severity, and duration using historical climate data [ (Karthika, et al., 2017), (Xhabafti, et al., 2024)]. On the other hand, the use of neural networks has been raised due to their characteristics to capture complex temporal dependencies and nonlinear patterns [ (Xhabafti, et al., 2024), (Yan, et al., 2021)]. However, the nature of droughts as a phenomenon requires the application and advantages of both groups of methodologies to capture all the patterns they can have. Therefore, the need for hybrid models has arisen, which in our case combine statistical methods with neural networks, such as ARIMA-ANN or SARIMA-LSTM hybrids, that can leverage the strengths of both approaches. These models can capture both linear and nonlinear relationships in the data and improve forecasting accuracy. Mahshid et al. predicted meteorological drought in seven stations of the Karkheh Basin using monthly rainfall data as well as the SPI index, employing the ARIMA method. From the results, the ARIMA model was useful for predicting drought, but the author's suggestions were to use artificial intelligence methods in future work as a result of the complexity of this phenomenon (Karimi, et al., 2019). Also M. Karthika et al. and Ommolbanin et al. forecast the drought using the ARIMA method but suggested at the end of the paper to use other forecasting methods such as ANN, Support Vector Machine (SVM), LSTM to predict hydrologic drought in medium and long term time scales[ (Karthika, et al., 2017), (Bazrafshan, et al., 2015)]. Dongfei et al., Nian et al. and Poormina and Pushpalatha forecasted drought using the LSTM



model proving the importance of neural network models specifically deep learning in the prediction of these events[ (Poornima & Pushpalatha, 2019), (Yan, et al., 2021), (Zhang, et al., 2020)]. As we mentioned above, there isn't a global solution that excels in every research domain and therefore, it's crucial to evaluate each situation individually, assessing the effectiveness of specific techniques or the combination of diverse approaches within each respective research domain. Considering the complex character and non-linearity of the drought process, algorithms that can simulate non-linear time series data are required. Therefore, an improvement has been made in their prediction by combining statistical and neural network methods for predicting this phenomenon. Xu et al. predicted drought for 7 sub-regions of China, using a total of six models (individual and hybrid), ARIMA, LSTM, SVR, ARIMA-SVR and ARIMA-LSTM (Xu, et al., 2022). It was concluded that hybrid models perform better than individual models with a higher prediction accuracy and smaller error based on prediction metrics such as RMSE, MAE, etc. Also Md. Munir et al. proposed a hybrid approach to predict drought by combining Wavelet transform, ARIMA and ANN (Khan, et al., 2020). Based on the  $R^2$  performance metric, the hybrid model performed better than the individual models, highlighting the importance of hybrid approaches in forecasting. Different authors have proven the importance of hybrid forecasting approaches compared to individual models, emphasizing that the nature of time series cannot be captured by only one methodology, but by a possible combination of statistical methods and neural networks [ (Schweidtmann, et al., 2024), (Sina, et al., 2023)]. By integrating various data sources, including meteorological, hydrological, and remote sensing data, these models enable a comprehensive understanding of the dynamics of drought, thereby providing information for decision-makers to implement measures that minimize the negative effects of drought in the region (Sina, et al., 2023). Our work focuses on the construction of a hybrid model to predict droughts in a city in Albania, which is known for its agricultural products and has a significant impact on the country's economy, intending to identify the improvements that this hybrid approach brings to the accuracy of the prediction and to see the impact that precipitation has had on these lands, directly affecting the agriculture of the area. First, we start with the presentation of the study area and data set as well as the methods that will be applied in this dataset. In the following results and discussions with all the corresponding values of each method are presented, comparing them through performance evaluation metrics such as RMSE, MAPE, and MSE. In the end, we conclude the results we get from the study, defining the conclusions of the paper.

## **MATERIAL AND METHODS**

In this section, we will briefly describe the study area, data and methods we will utilize regarding the long-term forecasting of the drought phenomenon at a location of interest. We will also describe the details of each methodology that were essential for its implementation.

### **Study Area and Data**

Albania, sheltered in the Western Balkans, is characterized by high temperatures and also precipitation in different months of the year and as such in the field of agriculture has always presented problems for farmers in the cultivation of various crops. The country's geography, characterized by mountains, valleys and a coastline along the Adriatic and Ionian seas, significantly affects rainfall patterns. Coastal regions receive milder rainfalls, while inland areas, particularly those located in mountainous terrain, experience more variable rainfall, with some regions experiencing relatively drier conditions. These often cause problems by causing floods, but on the other hand, their absence at different times throughout the year can cause another problem which, if accompanied by high temperatures, brings droughts. In our paper, a study of a city of Albania, Lushnje, which is known as one of the cities that cultivates the most different types of agricultural crops that also have an impact on Albania's economy, was taken. Our goal is to identify the impact that precipitation has had on these lands, directly affecting the agriculture of the area. The data were taken from January 1901 to December 2022, for average precipitation in mm in a month.



The original data were derived from the World Bank Climate Change Knowledge Portal (<https://climateknowledgeportal.worldbank.org/country/albania>).

## Methods

### *ARIMA and SARIMA model*

**ARIMA** is considered to be one of the most effective prediction methods for univariate time series models and has been applied for decades in various fields of forecasting in the domain of weather forecast such as: monthly temperature prediction (Goswami, et al., 2017), monthly precipitation prediction [ (Bari, et al., 2015), (Ahmed, 2017)] wind forecasting (Grigonytė & Butkevičiūtė, 2016) etc. This model has been widely used also in drought prediction in recent years [ (Karimi, et al., 2019), (Karthika, et al., 2017)]. The ARIMA model is known for its potential in short-term and long-term forecasts as well as in recognizing the trends that a time series can have depending on the phenomenon it is dealing with.

The utilization of the Box-Jenkins approach facilitated the construction of an ARIMA model. The ARIMA model is denoted as ARIMA (p, d, q), wherein p, d, and q correspond to the number of autoregressive parameters, degree of differencing, and the order of moving average, respectively (Sinaj, 2014). To be specific, p signifies the autoregressive order, d denotes the degree of differencing, and q implies the order of moving average, (G.E. & G.M., 1978).

$$\Delta^d Y_t = c + \varphi_1 Y_{t-1} + \varphi_2 Y_{t-2} + \dots + \varphi_p Y_{t-p} + \theta_1 \varepsilon_{t-1} + \theta_2 \varepsilon_{t-2} + \dots + \theta_q \varepsilon_{t-q} + \varepsilon_t \quad (1)$$

Where,  $\Delta Y_t = Y_t - Y_{t-1}$

If the data exhibits seasonal patterns, the corresponding models are going to be referred to as **SARIMA** models (p,d,q)(P, D, Q). It is described as shown in Equation (2) (G.E. & G.M., 1978).

$$\Phi_P(B^S)\varphi_p(B)(1 - B^S)^D(1 - B)^d Y_t = \Theta_Q(B^S)\theta_q(B)\varepsilon_t \quad (2)$$

### *ANN model*

**ANN** is a type of neural network that consists of neurons that are placed in hidden layers to perform calculations and its component layers are input, hidden, and output (Kakar, et al., 2018). The amount of neurons we use in our model corresponds to the number of input variables involved in the study. In ANNs, learning occurs through experiences, and the acquired knowledge is stored in connection weights between neurons that mimic the human brain (Khan, et al., 2018). The four main characteristics of the artificial neural network are: non-linear, non-limiting, non-qualitative and non-convex (Wu & Feng, 2018). After designing and training the multi-layer neural network with the existing data set, increasing the number of hidden layers, the trained neural network can classify and predict with a higher performance based on the values of the evaluation metrics (Kakar, et al., 2018).

The ANN model is widely used in various fields of forecasting, where it has also developed in the field of weather forecasting, achieving high performance results [ (Tareke & Awoke, 2023), (Khan, et al., 2018) ]. This neural network can accumulate knowledge, obtained from the environment through a learning process, and the weights within the network indicate the strengths of the neurons in maintaining this acquired knowledge (Kakar, et al., 2018).

### *Hybrid models*

As we saw in the above paragraphs, the application of individual models for time series forecasts is widely applied but with some limitations because of the complex problems we encounter today. The time series of the research object may contain linear and non-linear components, and an individual model cannot fully cover the forecast, therefore today the hybrid forecast model is applied, as a visible improvement reflected in the accuracy of the forecast. Various works have evidenced the effectiveness of the hybrid model of forecasting, both in general [ (Schweidtmann, et al., 2024), (Sina, et al., 2023), (Mucaj & Sinaj, 2017)] and in the field we have focused [ (Xu, et al., 2022), (Khan, et al., 2020),

(Jayagopal, et al., 2022)]. In our research, we will use the hybridization of the ARIMA and SARIMA with the ANN model, considering the advantages of each method to predict drought in the location defined in the study area paragraph.

#### Model performance evaluation

In this study, Root Mean Square Error (RMSE), Mean Square Error (MSE) and Mean Absolute Percentage Error (MAPE) were used as performance indicators of model evaluation (Zhao, et al., 2022). The specific calculation formulas are as follows:

$$RMSE = \sqrt{\frac{1}{n} \sum_{i=1}^n (y_i - \hat{y}_i)^2} \quad (1)$$

$$MSE = \frac{1}{n} \sum_{i=1}^n (y_i - \hat{y}_i)^2 \quad (2)$$

$$MAPE = \frac{1}{n} \sum_{i=1}^n \left| \frac{y_i - \hat{y}_i}{y_i} \right| \quad (3)$$

Where:

- $n$  is the number of observations.
- $y_i$  is the actual value for observation  $i$ .
- $\hat{y}_i$  is the predicted value for observation  $i$ .

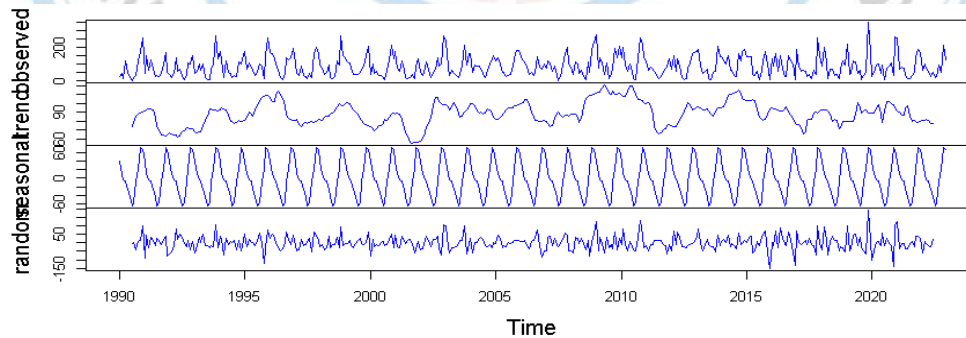
These metrics measure the average magnitude of the errors between predicted values and actual values in a dataset. Lower values indicate better model performance, as they indicate that the model's predictions are closer to the actual values.

## RESULTS AND DISCUSSIONS

### Individual models on meteorological drought prediction

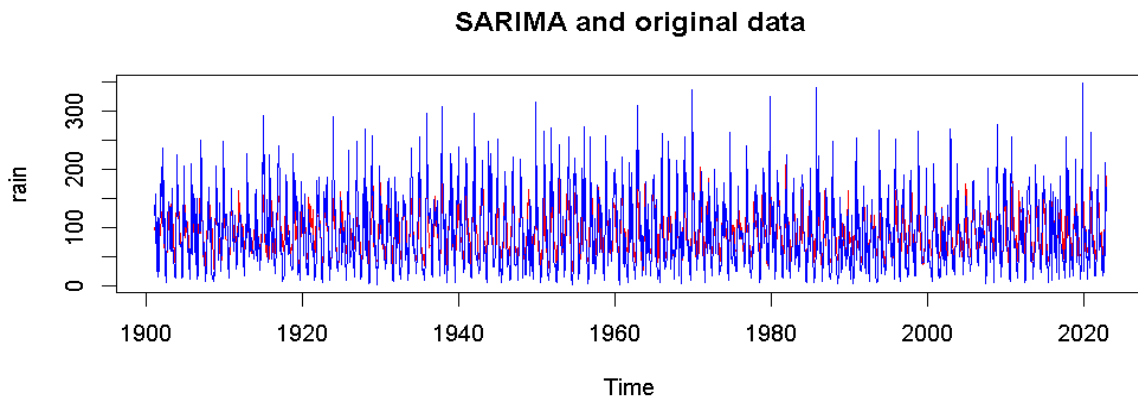
To find out the potential use of statistical models in fitting and forecasting precipitation for drought prediction, the ARIMA model is studied. The decomposition of the series shows the presence of trend, seasonality and random components as in **Figure 14**.

The Box-Jenkins technique suggests a SARIMA model which is ARIMA (3,0,1)(2,0,0)[12], suitable to fit the data based on the values of RMSE and MAPE which are 50.32302 and 96.30527.



**Figure 14:** Decomposition of additive time series of precipitation.

Even though the SARIMA model is the best in forecasting regarding statistical methods, it seems that it has not caught the irregular behaviours shown in **Figure 15**, which shows that we should rely on other forecasting techniques such as those of neural networks.



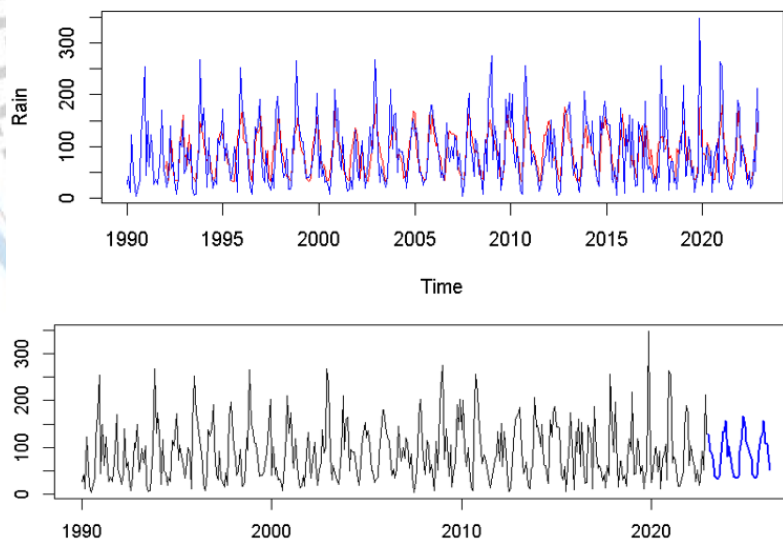
**Figure 15:** Comparison of SARIMA model forecasting and original data of precipitation

In the following, we have the implementation of the ANN model, seeing first the layer with two neurons and then with three neurons for the precipitation series. If we have a look at the results of **Table 12** where the evaluation metrics are presented, we see that the ANN model with three neurons performs better and has a higher prediction accuracy. In **Figure 16** we can evaluate that ANN (3) has caught most of the irregular behaviors by showing a better forecast. If we were to compare this model with the SARIMA model concluded above, we can say that the neural network model performed better in this prediction.

**Table 12:** Performance metrics for ANN with 2 and 3 neurons

	ANN (2)	ANN (3)
<b>RMSE</b>	48.26223	33.89779
<b>MAPE</b>	41.99203	70.87011

*Source: Authors Calculation's*



**Figure 16:** Comparison of ANN model forecasting and original data of precipitation and ANN forecasting

### Hybrid models on meteorological drought prediction

The models that are hybridized in this section are SARIMA-ANN and ARIMA-ANN. Specifically, the SARIMA and ARIMA model were used to extract the linear features of the precipitation variable, and neural network model such as ANN was used to extract the nonlinear features. For the first hybrid model, SARIMA-ANN, we combined the forecasts generated by the SARIMA model with the forecasts

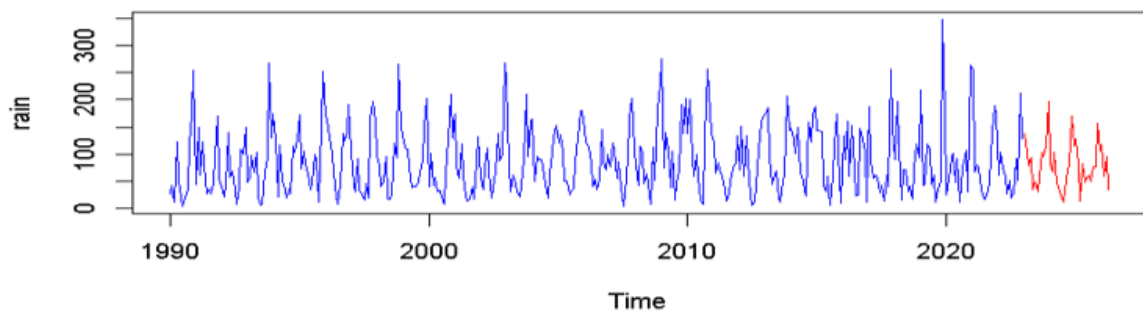


generated by the ANN model to obtain the final forecast by capturing temporal patterns and seasonality throughout SARIMA and capturing nonlinear relationships through the flexibility of ANN. For the second model, we used ANN method to model the residuals from the ARIMA model. After fitting the ARIMA model, the residuals were computed. These residuals represent the portion of the data that is not explained by the ARIMA model. Then the residuals from the ARIMA model as input features to train the ANN model. The ANN model learns the complex nonlinear patterns in the residuals and made predictions based on them. Finally, the predictions from both models are combined to produce the final forecast. This combination leverages the strengths of both models to improve the overall forecast accuracy. This hybrid model was developed based on weighted modeling and performed better than other individual and hybrid models. The performance metrics for each of these methods are shown in **Table 2** and based on these values, we conclude that ARIMA-ANN performs better than SARIMA-ANN, with lower values of error metric MAPE and MSE. In this paper, we initially compared the individual methods and then the hybrid models by showing the effectiveness of the model proposed. If we were to compare the hybrid model with each of the individual methods again, we see that based on the MAPE and MSE value, ARIMA-ANN performs better. **Figure 17** shows the forecast of the precipitation time series of the hybrid models, ARIMA-ANN and SARIMA-ANN.

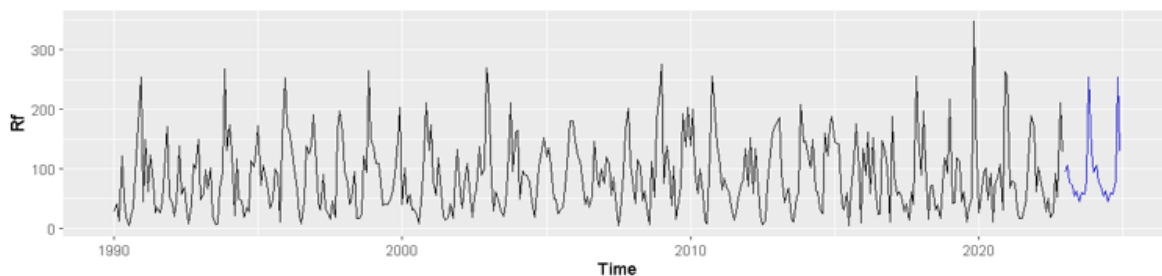
**Table 2:** Comparison of the performance metric MAPE for hybrid SARIMA-ANN and ARIMA-ANN.

	SARIMA-ANN	ARIMA-ANN
MAPE	3.642659	0.1170881
MSE	5.099877	0.490618

Source: Authors Calculation's



1) SARIMA- ANN forecast



2) ARIMA- ANN forecast

**Figure 17:** Comparison of hybrid models forecast.

## CONCLUSION

In this paper, the meteorological forecast of the drought was made Lushnje, a city in Albania, which is known for the cultivation of various crops, taking as a model the monthly precipitation data from January

1901 to December 2022, with the aim to identify the improvements that a hybrid approach would bring to the accuracy of the prediction and to evaluate the impact that precipitation has had on these lands, directly affecting the agriculture of the area and also of the economy of the country. We modeled individual statistical and neural network methods that were used for prediction, as well as their hybridization, specifically ARIMA, SARIMA, ANN, SARIMA-ANN and ARIMA-ANN. Based on the performance indicators of the analysed models, among the statistical models, ARIMA (3,0,1)(2,0,0)[12] performed better but again failed to capture the irregular behaviour of the series, leading to the need to test other models such as ANN, which performed better based in the lower values of performance evaluation metrics. In the third part of the results, we evaluated the performance of the hybrid models, SARIMA-ANN and ARIMA-ANN by concluding that ARIMA-ANN has the highest prediction accuracy. It was concluded that hybrid methods make a more accurate and qualitative prediction regarding the prediction of a phenomenon like droughts, by improving the accuracy of rainfall forecast month by month. Such a forecast can help the competent authorities to design policies, build structures and do a proper management of water resources in order to prevent this phenomenon for areas that cultivate different agricultural crops such as the study area we considered, due to the importance that it has in a country's economy. In the future, it is thought to use other variables to capture the complex nature that this phenomenon has, or indexes like SPI or SPEI and even why in Albania the localization of this nature of data is a bit challenging. Other models can also be proposed to hybridization and used in our studies to see their accuracy compared to what we concluded.

#### References

- Ahmed, F., 2017. Application of ARIMA Models in Forecasting Monthly Total Rainfall of Rangamati, Bangladesh. *Asian Journal of Applied Science and Engineering*, 6(2), pp. 95-102.
- Bari, S. H., Rahman, M., Hussain, M. & Ray, S., 2015. Forecasting Monthly Precipitation in Sylhet City Using ARIMA Model. *Civil and Environmental Research*, 7(1), pp. 69-77.
- Bazrafshan, O. ve diğerleri, 2015. Hydrological Drought Forecasting using ARIMA Models (Case Study: Karkheh Basin). *ECOPERSIA*, 3(3), pp. 1099-1117.
- Box, G. E. P., Hunter, J. S. & Hunter, W. G., 2005. *Statistics for Experimenters: Design, Innovation, and Discovery*. Second Edition. New Jersey: John Wiley & Sons, Inc..
- G.E., B. & G.M., J., 1978. Applications of Time Series Analysis. *Contributions to Survey Sampling and Applied Statistics*, pp. 203-219.
- Goswami, K., Hazarika, J. & Patowary, A. N., 2017. Monthly Temperature Prediction Based On Arima Model: A Case Study In Dibrugarh Station Of Assam, India. *International Journal of Advanced Research in Computer Science*, 8(8), pp. 292-298.
- Grigonytė, E. & Butkevičiūtė, E., 2016. Short-term wind speed forecasting using ARIMA model. *Energetika*, 62(2), pp. 45-55.
- Jayagopal, P. ve diğerleri, 2022. Weather-based maize yield forecast in Saudi Arabia using statistical analysis and machine learning. *Acta Geophysica*, Cilt 70, p. 2901–2916.
- Kakar, S. A. ve diğerleri, 2018. Artificial Neural Network based Weather Prediction using Back Propagation Technique. *International Journal of Advanced Computer Science and Applications*, 9(8), pp. 462-470.
- Karimi, M. ve diğerleri, 2019. Analysis and prediction of meteorological drought using SPI index and ARIMA model in the Karkheh River Basin, Iran. *Extreme Hydrology and Climate Variability*, pp. 343-353.
- Karthika, M., Krishnaveni & V.Thirunavukkarasu, 2017. Forecasting of meteorological drought using ARIMA model. *Indian Journal of Agricultural Research*, 51(2), pp. 103-111.
- Khan, M. M. H., Muhammad, N. S. & El-Shafie, A., 2018. Wavelet-ANN versus ANN-Based Model for Hydrometeorological Drought Forecasting. *Water*, 10(8), p. 998.
- Khan, M. M. H., Muhammad, N. S. & El-Shafie, A., 2020. Wavelet based hybrid ANN-ARIMA models for meteorological drought forecasting. *Journal of Hydrology*, Cilt 590.
- Mucaj, R. & Sinaj, V., 2017. Exchange Rate Forecasting using ARIMA, NAR and ARIMA-ANN Hybrid Model. *Multidisciplinary Engineering Science and Technology*, 4(10), pp. 8581-8586.

- Poornima, S. & Pushpalatha, M., 2019. Drought prediction based on SPI and SPEI with varying timescales using LSTM recurrent neural network. *Soft Computing*, Cilt 23, p. 8399–8412.
- Schweidtmann, A. M., Zhang, D. & Stosch, M. v., 2024. A review and perspective on hybrid modeling methodologies. *Digital Chemical Engineering*, Cilt 10, p. 100136.
- Sinaj, V., 2014. Models to forecast inflation in Albania. *International Journal of Scientific & Engineering Research*, 5(1), pp. 590-594.
- Sina, L. B., Secco, C. A., M. B. & Nazem, K., 2023. Hybrid Forecasting Methods—A Systematic Review. *Electronics*, 12(9), p. 2019.
- Tareke, K. A. & Awoke, A. G., 2023. Hydrological drought forecasting and monitoring system development using artificial neural network (ANN) in Ethiopia. *Heliyon*, 9(2).
- Wu, Y.-c. & Feng, J.-w., 2018. Development and Application of Artificial Neural Network. *Wireless Personal Communications*, Cilt 102, p. 1645–1656.
- Xu, D., Zhang, Q., Ding, Y. & Zhang, D., 2022. Application of a hybrid ARIMA-LSTM model based on the SPEI for drought forecasting. *Environmental Science and Pollution Research*, Cilt 29, p. 4128–4144.
- Xhabafti, M., Vika, B. & Sinaj, V., 2024. A comparative study of Statistical and Deep Learning Model-Base Weather Prediction in Albania. *Computer Research*, Cilt 12, pp. 151-160.
- Yan, D. ve diğerleri, 2021. Characteristics and prediction of extreme drought event using LSTM model in Wei River Basin. *Terrestrial, Atmospheric and Oceanic Sciences*, 32(2), pp. 261-274.
- Zhang, N., Dai, X., Ehsan, M. A. & Deksissa, T., 2020. Development of a Drought Prediction System Based on Long Short-Term Memory Networks (LSTM). *Advances in Neural Networks*, Cilt 12557, pp. 142-153.
- Zhao, J., Nie, G. & Wen, Y., 2022. Monthly precipitation prediction in Luoyang city based on EEMD-LSTM-ARIMA mode. *Water Science & Technology*, 87(1), p. 318–335.

#### **Conflict of Interest**

The authors have no conflicts of interest to declare that are relevant to the content of this article.

#### **Author Contributions**

The authors equally contributed in the present research, at all stages from the formulation of the problem to the final findings and solution.



## Evaluating Forecasting Models via Simulation

Drp. Katerina ZELA<sup>1</sup>

<sup>1</sup>Mediterranean University of Albania, Faculty of Informatics, Department of Information Technology  
Tirana, Albania

Corresponding Author e-mail: katerina.male@umsh.edu.al

### Abstract

*This study investigates various forecasting models by simulating multiple data scenarios, including both linear and nonlinear processes. The research aims to determine the most effective models based on the data characteristics, employing a mixture of traditional and modern analytical techniques. Nowadays, large quantities of data are being collected for analytical and forecasting purposes. They not necessarily have the same data generating process; thus, it might be difficult identifying a single forecasting model to apply to all possible scenarios. Considering a time series as an independent dataset, choosing whether to apply whether a linear or a nonlinear forecasting model separately, may lead to inaccurate results, which means inappropriate future interventions and decisions.*

*This paper regards a simulation study for the quantitative evaluation of the dependence of the forecasting models' performance on the characteristics of the data. We have simulated several datasets with known time series characteristics, under controlled conditions, including linear data generating processes, such as Autoregressive (AR), Seasonal Autoregressive (SAR), and nonlinear ones such as Self-Exciting Threshold Autoregressive (SETAR) and Logistic Map. Heterogeneous time series are obtained by combining several data generating processes into one time series, to identify the more appropriate forecasting model for real world datasets, while the length and the number of the series are varied in different scenarios, to explore the effect of data availability on the performance of the forecasting models.*

*We have performed forecasts using both linear and nonlinear forecasting models, an Autoregressive Integrated Moving Average (ARIMA) model, a Linear Exponential Smoothing model, an Exponential smoothing state space model with Box-Cox transformation, ARMA errors, Trend and Seasonal components (BATS) and Trigonometric seasonality Box-Cox transformation ARMA errors Trend and Seasonal components (TBATS) model and a Nonlinear Autoregressive Neural Network (NARNN) and compared their performance in terms of percentage errors.*

**Keywords:** Data Generating Process, Forecasting, Nonlinear models, NARNN.

### 1. Introduction

The future trend prediction of a phenomenon has always been crucial for scientific research, always worrying scholars of various fields. The forecasting models are based on the idea that the past affects the future. Forecasting future trends is a perennial challenge in scientific research, involving complex data patterns that often require advanced prediction methods. Recently, machine learning techniques such as neural networks have become popular for their robustness in handling complex data structures, providing significant improvements over traditional statistical methods. Therefore, it is assumed a continuity of the activity's trend, the existence of a continuity in the data collected so far [1]. This is the reason why having accurate prediction remains, even today, a difficult and challenging issue. Recently, thanks to the development of automatic methods in various fields, time series are being modeled using artificial intelligence methods. New techniques based on Artificial Intelligence such as Artificial Neural Networks, Decision Trees, Support Vector Machines or Genetic Algorithms are some of the Machine Learning models used for modeling and prediction of time series [2]. Traditional statistical methods are the basis on which modern computational techniques are integrated for data analysis. Artificial Neural Networks (ANN) are one of the most used models in the field of time series forecasting. They are nonlinear techniques, which makes them more suitable in modeling complex data patterns [3]. They are

function approximation techniques that learn the relationship between inputs and outputs, and make no assumptions or conjectures about the statistical distribution, or properties of the data.

When considering real data, forecasters usually face multi-step-ahead forecasting problems, with short, medium- or long-term horizons. It consists in predicting several future values considering a given sequence of historical observations of a univariate time series.

## 2. Tools and methodology

Our approach involves simulating different data generating processes to closely mimic real-world data scenarios. We explored both single and multiple time series scenarios across homogeneous and heterogeneous datasets to thoroughly assess the performance of various forecasting models under diverse conditions.

We have differentiated our data considering the number of the series, their length and amount and heterogeneity of the data. The data generating processes we have simulated are very close to practical scenarios. We have initially considered linear processes and then increased the complexity of the series by introducing nonlinear data generating processes, such as the threshold autoregressive model and the logistic map. For each of them, we have furtherly considered:

1. Single and multiple series scenarios: for every single time series, we have split it into multiple shorter equal length series, in order to quantitatively evaluate whether it makes any difference for the model's performance to learn from data on one long series or through multiple ones;

2. Homogeneous and heterogeneous scenarios: for multiple series, we have simulated both homogeneous and heterogeneous scenarios, by combining different data generating processes in a dataset, in order to compare the models' performance in combined linear and nonlinear time series.

For every scenario, we generate up to 10 time series, whose length varies from a minimum length of 20 observations for the SAR data generating process, up to a maximum length of 6000 observations for the logistic map, with a daily frequency. The following table presents the characteristics of datasets for all data generating processes:

**Table 1:** Characteristics of datasets for all the chosen data generating process

DGP	Scenario	Nr. DGP	Min Length	Max length	Forecast horizon
AR	SS*	1	50	1000	30
	MS-Hom-Short**	1	50	50	30
	MS-Hom-Long***	1	50	100	30
	MS-Het****	10	50	100	30
SAR	SS	1	20	2000	30
	MS-Hom-Short	1	20	20	30
	MS-Hom-Long	1	20	200	30
	MS-Het	10	20	200	30
Logistic Map	SS	1	60	6000	30
	MS-Hom-Short	1	60	60	30
	MS-Hom-Long	1	60	600	30
	MS-Het	10	60	600	30
SETAR	SS	1	60	6000	30
	MS-Hom-Short	1	60	60	30
	MS-Hom-Long	1	60	600	30
	MS-Het	10	60	600	30

\*Single series

\*\*Many Series Homogeneous with Short Length

\*\*\*Many Series Homogeneous with Long Length

\*\*\*\*Many Series Heterogeneous

*Linear Autoregressive models*

Firstly, we have simulated an AR data generating process. AR models use a linear combination of the past time series values, an error term and a constant to predict future values. They can be expressed as:

$$y_t = \varphi_0 + \sum_{i=1}^p \varphi_i y_{t-i} + \varepsilon_t = \varphi_0 + \varphi_1 y_{t-1} + \varphi_2 y_{t-2} + \dots + \varphi_p y_{t-p} + \varepsilon_t$$

We have chosen an AR (3) data generating process to simulate time series close to the real-world scenario and simulated it using the *arima.sim* function of the “stats” R package.

#### Seasonal Autoregressive models

A Seasonal Autoregressive Model uses seasonal lags of the time series to predict future values, allowing us to simulate scenarios very close to real-world time series that have seasonal components:

$$\Phi_p(B^S)\varphi(B)\nabla_S^D\nabla^d x_t = \Theta_Q(B^S)\theta(B)w_t$$

We have chosen a SAR (1) data generating process to simulate time series close to the real-world scenario and simulated it using the *simulate* function of the “forecast” package [4].

#### Logistic Map

The logistic map is a data generating process that generates nonlinear time series, firstly introduced by May (1976). It is a second-grade polynomial map, defined as:

$$y_t = ry_{t-1}(1 - y_{t-1}) + \varepsilon_t$$

where  $r$  is a positive number between 0 and 4 that influences the system’s nonlinear dynamic behavior.

#### Self-Exciting Threshold Autoregressive Models

This data generating process belongs to the TAR models family, firstly introduced by Tong (1978). They belong to the regime-switching model class. It involves  $k-1$  threshold values that separate the space into  $k$  regimes each of whom is modelled by a different AR process. TAR models generate nonlinear time series through a regime-switching technique that changes the coefficients when a determined value of threshold is met. The TAR model where the threshold variable ( $z_t$ ) is a lagged value of the series, the model is known as a SETAR model. A SETAR model of  $k$  regimes and a threshold value  $y_{t-d}$  is defined as:

$$y_t = \begin{cases} \phi_0^1 + \phi_1^1 y_{t-1} + \dots + \phi_{p_1}^1 y_{t-p_1} + \varepsilon_t^1 & \text{if } z_t \leq r_2 \\ \phi_0^j + \phi_1^j y_{t-1} + \dots + \phi_{p_j}^j y_{t-p_j} + \varepsilon_t^j & \text{if } r_1 \leq z_t \leq r_2 \\ \dots \\ \phi_0^k + \phi_1^k y_{t-1} + \dots + \phi_{p_k}^k y_{t-p_k} + \varepsilon_t^k & \text{if } r_{k-1} \leq z_t \end{cases}$$

We have chosen a SETAR model to simulate time series close to the real-world scenario and implemented it using the *setar.sim* function of the “tsDyn” package.

### 2.1. Forecasting models

Considering both the linear and nonlinear forecasting models, the considered data set was divided into three parts, which were used for the identification of the model, the performance evaluation and its ability to generalize. The data were divided into a training set, validation set and test set.

The training set contains data that are used for the identification of the model, by uncovering the traits of the data generating process on the inputs and exploring the relationship between inputs and the outputs, through a supervised learning technique [5]. For the linear models, the training set helps estimate the model’s parameters, while for the nonlinear forecasting models it helps train the network, that includes the determination of the weights between the nodes. Usually, the training set, which is the



largest set, contains the major part of the time series data (55% - 85%).

The validation set is used to test the forecasting model's ability of generalizing on unknown data. It follows an unsupervised learning logic, as the inputs are fed to the model, while the correspondent outputs are unknown to it. It is its task to associate the right outputs to the given input values, relying on the learning procedure the model faced during the training phase [6], It contains from 10 to 30 % of the training set amount of data. Usually, the most recent time series observations are considered to be part of the validation set for the evaluation of the generalization abilities of the model and, consequently, comparing the forecasting performances of each considered model. A very common and most used parameter for the comparison of the forecasting models' predicting abilities, among the mean and percentage errors, is the Mean Absolute Percentage Error (MAPE) [4]. Thus, the validation set lets us identify the model (number of nodes, parameters) that is the most capable of correctly generalizing on unseen data.

We segmented the data into training, validation, and testing phases to evaluate the models' performance comprehensively. The primary metrics for comparison were the Mean Absolute Percentage Error (MAPE) and the ability of models to generalize unseen data.

The test set is used for applying the forecasting model to produce forecasts for a one-step-ahead or multi-step-ahead period [7]. If the considered model is able of learning the features of the data set through the training procedure, but is not able to produce correct results when applying the model to the test set (shows a high error value for the validation set), it presents overfitting problems. The overfitting refers to the ability of the model to correctly capture and identify the underlying pattern of the data and associate the right output to the given input data, and its inability of applying the learned rule to the unknown input data, being unable to associate the correct outputs to the correspondent input data.

We have allocated 60% of data to the training set for the model identification, the parameter choice and the determination of the coefficients and, for the nonlinear forecasting models for the network learning procedure and the determination of the weights between the nodes. 25% of data were allocated to the validation set for the evaluation of the models' accuracy and its generalizing capability. The validation data were chosen between the most recent data and are different from the ones used for the training procedure. The results produced by the training will be the choosing parameter between the models, preferring the one with the lowest validation error value. The remaining 15% of time series data were chosen for the test set for a step ahead forecasting over unused data before. We have used an Autoregressive Integrated Moving Average (ARIMA) model, a Linear Exponential Smoothing model, an Exponential smoothing state space model with Box-Cox transformation, ARMA errors, Trend and Seasonal components (BATS) and Trigonometric seasonality Box-Cox transformation ARMA errors Trend and Seasonal components (TBATS) model, and a Feed-Forward Neural Network (FFNN) and compared their performance in terms of percentage errors.

### 3. Results

Our findings indicate that while traditional linear models performed well under linear scenarios, neural networks and other nonlinear models were superior in complex and mixed data environments. The performance metrics across different models highlighted the importance of model selection based on specific data characteristics. Selection and accuracy measures for the forecasting models are reported in Table 1. We chose the best forecasting model according to the validation set MAPE value, as it is recommended as an accuracy comparing unit when using different methods on a time series, considering as the most accurate model the one with the lowest MAPE value.

**Table 2:** MAPE values for the validation set

Model	SS	MS-Hom-Short	MS-Hom-Long	MS-Het
<b>AR(3)</b>				
ARIMA	14.11	43.65	22.06	16.42
NARNN	15.84	45.81	25.89	13.05
BATS	14.93	43.18	24.85	18.71
TBATS	14.77	40.04	24.71	19.16
Holt's	14.91	43.16	24.72	18.85
<b>SAR(1)</b>				
SARIMA	16.21	21.70	35.48	20.52
NARNN	17.54	23.64	34.15	18.66
BATS	16.32	22.36	39.46	19.30
TBATS	16.28	21.94	38.92	19.45
Holt's	16.98	22.27	37.15	20.17
<b>Logistic Map</b>				
ARIMA	38.32	36.39	29.34	25.79
NARNN	26.60	34.25	24.53	21.67
BATS	37.96	36.02	30.16	22.81
TBATS	37.54	37.18	31.34	22.60
Holt's	37.52	37.23	29.47	24.55
<b>SETAR</b>				
ARIMA	28.15	31.47	26.42	29.49
NARNN	15.33	21.35	17.30	15.42
BATS	24.38	27.68	29.16	32.74
TBATS	25.02	29.33	29.05	32.58
Holt's	29.44	28.42	27.15	34.92

Considering the AR (3) data generating process, in the single series case, the ARIMA model outperforms in terms of MAPE, since the time series generating process is an autoregressive model, followed by the other linear forecasting models, which almost share the same MAPE value. ARIMA's predictive capabilities become worse as the length of the time series gets shorter (MS-Hom-Short scenario). However, MAPE values remain lower for the linear models in comparison to the NARNN model, which seems to be the worst model for forecasting autoregressive generating process time series, for both single series and many homogeneous short-length series. When considering the heterogeneous series (MS-Het), the NARNN's MAPE decreases and becomes lower than the other linear models. It seems that the neural network has better capabilities in capturing and analyzing the underlying pattern of heterogeneous times series, considering the complex structure of these series and the model's capability of learning across the data. Its MAPE values are slightly lower than the linear models' for the single and homogeneous time series scenarios, and the difference between the nonlinear model's MAPE and the linear model' MAPE increases in the heterogeneous time series simulated scenario. We can notice that the forecasting accuracy of each model improves as the length of the series increases.

For the SAR (1) data generating process, SARIMA is the better performing linear model for the single and many homogeneous short-length time series scenarios, as it is the closest model to the data generating process. The NARNN outperforms the SARIMA model in the heterogeneous and homogeneous series of longer length, thanks to the ability of nonlinear models to learn across such series. The other linear models follow SARIMA, although with slightly higher values. Once again, we can observe the higher abilities of nonlinear models of generalizing the rule learned during the training procedure, thanks to the presence of the nonlinear component. They present a slightly higher MAPE value for the single series and the short homogeneous data generating process scenario in comparison

to the SARIMA model, but the neural net's generalizing abilities result higher when considering the long homogeneous and the heterogeneous time series data generating process scenario. Once again, all the models' forecasting values become more accurate as the size of the dataset increases.

In the Logistic Map data generating process, the nonlinear patterns of the time series are better captured by the nonlinear models, that outperform the linear models in all the different scenarios. The results of the validation set errors confirm the higher ability of nonlinear models, especially the neural network, of generalizing the rule learned during the training phase.

For the single series case, the neural network model has the best capability of capturing the nonlinear traits of the data generating process that are not captured by the linear models. Its MAPE slightly increases when considering many short-length homogeneous series, as it becomes more difficult for these models to learn from smaller datasets. In the homogeneous long series, although the neural network model remains the best forecasting model, the length of the individual series is sufficient for the ARIMA model to learn, as the decrease of its MAPE value is notable (from 38.32 in the SS, to 29.84 in the MS-Hom-Short). Lastly, in the Logistic Map, as in previous data generating processes scenarios, it is notable that the models improve with increased amount of data in the dataset.

Considering the SETAR data generating process, the neural network predicts the validation set output values quite accurately. So, following a supervised learning logic, it is able to associate to inputs, output values that are very close to the actual time series data. The best predictive model under the short series scenario is the neural network model, which has a lower MAPE value with respect to the other linear and nonlinear predicting model. The complexity of the data generating process is more visible by it in the many homogeneous long series scenario, while it slightly increases in the short series scenario, due to the fact that these models perform better in larger datasets scenarios, since more data is used for the training.

#### 4. Conclusions and recommendations

The study confirms the critical role of appropriate model selection in forecasting. Nonlinear models, particularly neural networks, demonstrate significant potential in managing the intricacies of mixed and nonlinear data, suggesting their suitability for modern analytical challenges.

After simulating various data generating process time series scenarios, we provided an analysis on the possible factors that affect the predictive performance of each model.

The forecasting performance of all these models were evaluated using the mean absolute percentage error (MAPE), while the model fits were evaluated using AIC (Akaike Information Criterion).

Comparing the training set MAPE values for all the implemented forecasting models, we can notice that the linear models present lower values for the linear scenarios, while the MAPE values get higher when considering the nonlinear simulated models. This because during the learning procedure they are not capable of detecting and uncovering the nonlinear traits of the relationship between inputs and outputs for the nonlinear scenarios. This brings difficulties when applying them to the SETAR model or the logistic map. Their learning abilities improve when considering the linear data generating processes (AR and SAR models) as they perfectly identify and model the linear features of the relationships between input and output values.

The low rate of training set errors for the simulated scenarios for the nonlinear models indicates that they have higher and more accurate prediction capabilities as they can learn through data and generate good forecasting results.

Analogically, we can notice a more improved learning ability of the nonlinear forecasting models when trained with the linear data generating processes' data. Their abilities of discovering linear traits between linear data generating processes' data are higher compared to the ability of the linear forecasting models of detecting nonlinear traits in nonlinear data generating processes' data, as the MAPE value they present is lower in comparison with the linear models'. When considering the learning abilities of



the nonlinear forecasting models for the nonlinear scenarios, we notice, as expected, lower MAPE values, which indicates their great abilities of modelling nonlinear relationship between data for the nonlinear data generating processes.

As expected, ARIMA shows better forecasting abilities and more accurate forecasts for linear data generating process time series, while the NARNN model gives more accurate results for nonlinear data generating process time series. NARNN forecasting model is particularly competitive in long-length time series and heterogeneous datasets, thanks to its abilities of detecting both linear and nonlinear features between input and output data in a very effective way. Thus, we can state that these models are particularly promising for forecasting under uncertainty conditions, without knowing a priori the traits of the series.

### References

- [1] Brockwell PJ, Davis RA. (2016). *Introduction to time series and forecasting*. Berlin, Germany: Springer.
- [2] Cryer JD, Chan KS. (2008). *Times series analysis with applications in R*. Berlin, Germany: Springer.
- [3] Zhang, G., Patuwo, B.E., & Hu, M.Y. (1998). Forecasting with artificial neural networks: The state of the art. *International Journal of Forecasting*, 14(1), 35–62.
- [4] Hyndman, R.J., & Koehler, A.B. (2006). Another look at measures of forecast accuracy. *International Journal of Forecasting*. 22(4), 679-688.
- [5] Medeiros, M.C., Teräsvirta, T., & Rech, G. (2006). Building neural network models for time series: a statistical approach. *Journal of Forecasting*, 25(1), 49–75.
- [6] Zhang, G. P. (2001). An investigation of neural networks for linear time-series forecasting. *Computers & Operations Research*, 28(12), 1183–1202.
- [7] Lapedes, A.S. & Farber R.M. (1988). How neural nets work. *Neural information processing systems*, 442–456.

## Characterization of Consumers Who Demand More EU Eco-Labels in Accommodation Services

**Oscar Trull<sup>1\*</sup>, Genoveva Ortiz-Masiá<sup>2</sup>, Angel Peiró-Signes<sup>2</sup>, Marival Segarra-Oña<sup>2</sup>**

<sup>1</sup>Universitat Politècnica de València, Department of Applied Statistics, Operational Research and Quality, E-46022, Valencia, Spain

<sup>2</sup>Universitat Politècnica de València, Department of Business Organization, E-46022, Valencia, Spain

\*Corresponding author e-mail: otrull@eio.upv.es

### Abstract

*The use of eco-labels in the hotel industry has increased rapidly in recent decades in parallel with growing customer interest in sustainability. For these consumers, the eco-label acts as a differentiating factor when evaluating and selecting their purchasing options or acquisition of accommodation services. In this article, a preliminary statistical analysis is carried out on data from the Eurobarometer Flash 535 to determine the sociodemographic characteristics of European citizens related to the requirement for EU eco-labels in accommodation services.*

*Using descriptive statistics methodologies, relationships between variables present in the data source are analyzed, and the results obtained are discussed.*

**Keywords:** Sustainability, Ecolabel, Competitive Advantage.

### INTRODUCTION

Sustainability has become a priority, both at the political level and for many sectors, including tourism. In this sense, ecological labels or ecolabels (EE) are one of the most useful tools of environmental information policy. For its part, tourism is one of the key sectors that is expected to accelerate global efforts towards sustainable development. Consequently, there is also renewed interest in understanding and influencing tourists' attitudes and behaviors (Adongo et al., 2018).

The EEU (European Ecolabel) guarantees that certified accommodations have optimized environmental and waste management, and have reduced energy consumption, water consumption, transport emissions and food waste (Candela et al., 2016). In general, the role of ecolabels is twofold. On the one hand, the companies offering these services are required to follow a series of specific environmental practices and policies and on the other hand, they have the important function of providing simple and accessible information to the consumer about the environmental and sustainable attributes of these services creating greater environmental awareness and promoting more responsible behaviors (Peiró Signes et al., 2023).

The hotel accommodation sector, like others, considers green marketing as a value creation tool, with a view to obtaining a competitive advantage, as well as a way of growth, differentiation and establishment in the market. This is because consumers often take ecological issues into consideration when making a purchase due to the relationship between the implementation of green practices, increased environmental awareness, and loyalty to green hotels (Laroche et al., 2001, Preziosi et al., 2019).

The objective of this study is to characterize these consumers who would like more EEU in accommodation services, with the purpose of being able to be identified more easily. The study focuses specifically on the effect of the sociodemographic characteristics of these consumers. The research question that is intended to be answered. Therefore, it would be to define which sociodemographic profiles of consumers show a greater propensity to demand more EEU in accommodation.

The results of this study could help governments in the design and planning of future public policies

on sustainable accommodation services and eco-labelling. On the other hand, they could also be equally useful when taken into consideration in the design of marketing policies and plans of both tourist destinations and tourism companies.

## MATERIAL AND METHODS

### Material

To carry out this study, data from the Eurobarometer Flash 535 (The EU Ecolabel) from September 2023 have been used. In this survey that evaluates the knowledge of EU citizens about the EEU and their attitudes towards EE in general, between September 5 and September 13 (European Commission, 2023).

To carry out this survey, a representative sample of the European population was interviewed, composed of 26,630 citizens aged 15 years or older, in each of the 27 member states of the European Union (EU), using computer-assisted web interviews (CAWI). The main sociodemographic characteristics of the samples are summarized in Table 1.

**Table 1.** Demographic characteristics of the sample. Source: self made

Age	Gender			Total
	Women	Men	Not Specified	
15-25	51.35%	47.66%	1.03%	12.35%
25-39	52.94%	46.52%	0.54%	23.85%
40-54	49.61%	50.04%	0.35%	25.87%
55+	51.53%	48.34%	0.13%	37.94%

A total of 187 variables are collected in the survey, most of them qualitative in nature, and consist of dichotomous or categorical information. The target variable of the study is called Q6\_7, which qualitatively measures the desire to find more tourist accommodation services (hotels/campsites) with EEU. This objective variable has been compared with a series of sociodemographic variables in order to adequately characterize the consumers object of this research. The questions posed in the survey corresponding to these variables considered, as well as the possible values of the answers, are summarized in Table 2.

**Table 2.** Variables considered in the study. Source: self-made.

Variable	Question	Values and Labels
Q6_7	Would you like to find more products with the EU Ecolabel in any of the following categories? Tourist accommodation services (hotels/campsites)	1 Yes 2 No 997 Not applicable (I do not purchase these products/services) 998 I don't know
D2	Gender	1 Man 2 Woman
D1R1	Which of the following describes how you think about yourself?	3 Otherwise / I prefer not to say 1 15 - 24 years 2 25 - 39 years 3 40 - 54 years 4 55 years and over
D4R2	Recoded age - 4 categories How old is she?	1 Up to 15 2 16-19 3 20 years and more
	Education by age (recoded 5 categories)	996. Still in full-time education 997 I have never been in education full time. 998 I don't know 999 Rejection



### Data Analysis

Prior to data analysis, an initial visual and descriptive exploration of the data has been carried out, consisting of the review, characterization and structuring of the data obtained. This previous analysis has been carried out using software tools commonly used in business intelligence, such as Tableau and Microstrategy.

To obtain and validate the results of the analysis, the objective variable of the study Q6\_7 has been compared with each of the remaining demographic variables through cross tables and their corresponding statistical contrast using the chi-square test.

### RESULTS

The sex variable has turned out to be significant, since its p value of the chi square test is much lower than that of significance ( $p < 0.05$ ). The results indicate that women are more likely to want more accommodation services with this EEU (see Figure 1).

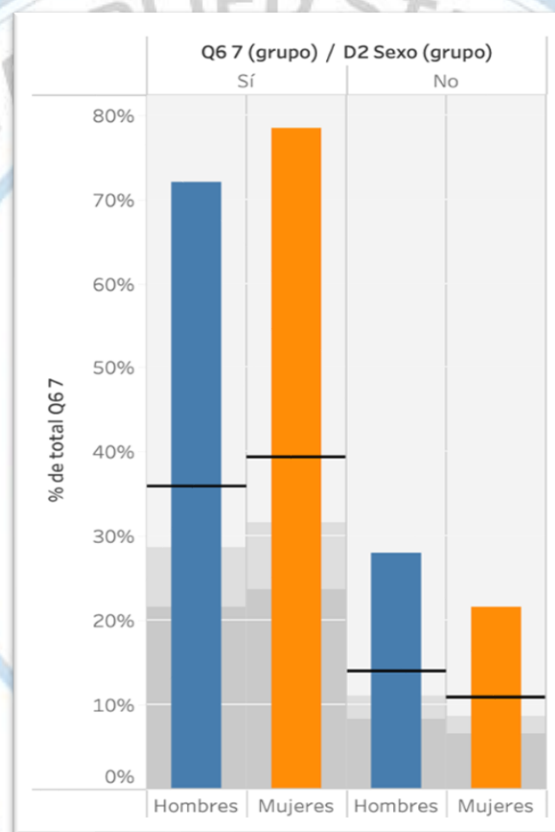
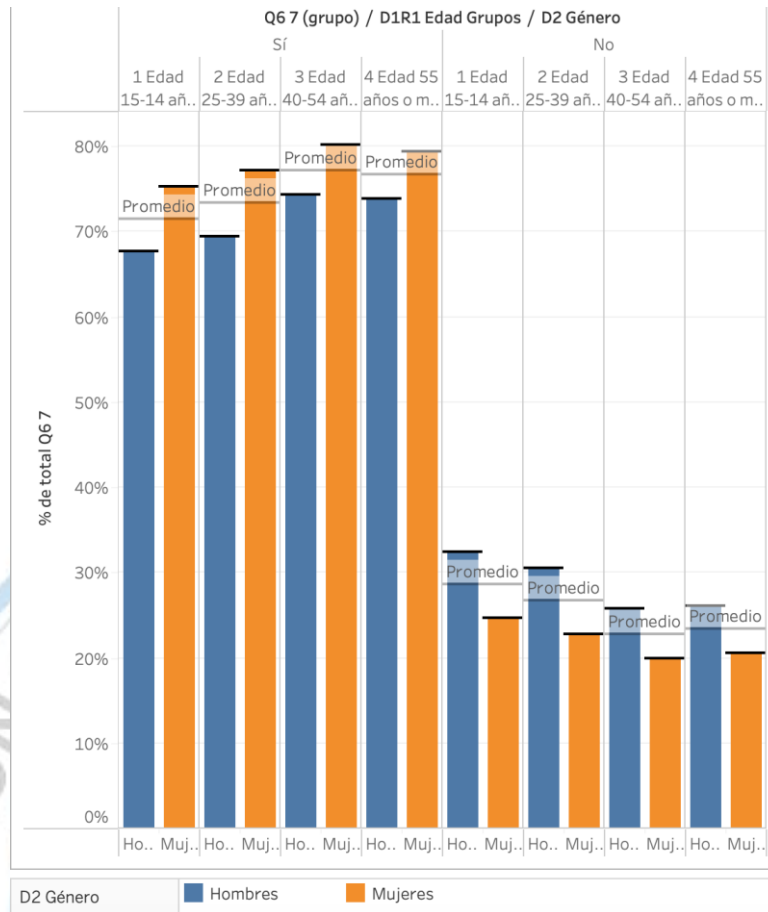


Figure 1. Comparison of D2 against Q6\_7.

The analysis of the variable DIR1 with respect to our objective variable Q6 7, indicates that age groups 1 and 2 corresponding to an age up to 39 years are significantly different ( $p$ -value  $< 0.05$ ) to groups 3 and 4 of age corresponding to people aged 40 or over.

The results also indicate that people over 39 years of age have a greater probability of wanting more accommodation services with the EEU, while this probability increases in parallel with the age group up to 39 years of age, we can also see in Figure 2 that between group 3 and 4 these differences are reduced in both men and women.

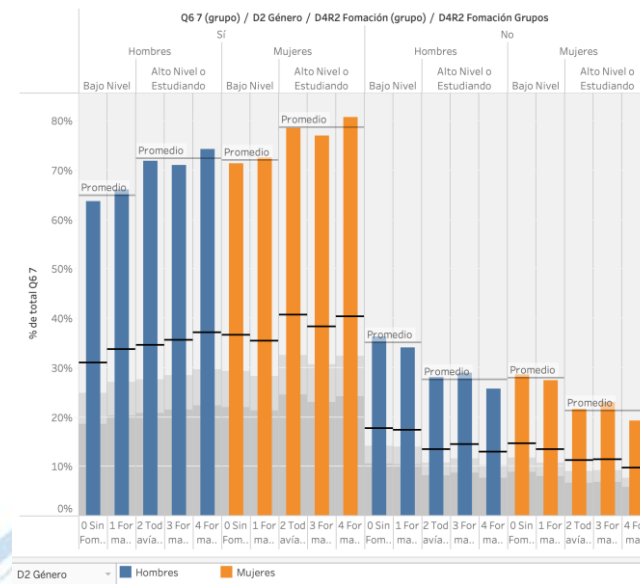


**Figure 2.** Comparative Count Q6 7 vs Age (D1R1) / Sex (D2). Source: self made.

The variable D4R2 groups the respondents according to the age at which they stopped studying full-time, that is, it qualitatively quantifies their educational level. We could find the most significant statistical group is made up of those respondents who finished their full-time studies at 20 years or more, followed by those who finished with between 16 and 19 years old and those who are still training full time.

In view of the results, those respondents who finished their full-time studies at more than 15 years of age or those who are still training, therefore, those with a higher educational level, are more likely to say that they want more of these health services. accommodations have the EEU.

When crossing data from these two training groups with the gender of the respondents, it is observed that the difference between men and women continues to be significant, even classifying individuals by training groups, as can be seen in Figure 3.



**Figure 3.** Comparative graph of Q6\_7 frequencies vs. Training Level / Gender. Source: self made.

## DISCUSSION AND CONCLUSION

This study contributes to enriching the literature on the main factors that affect the choice of eco-labeled accommodation services, highlighting that the sample studied covers all EU countries, so it is not a single market study like many of the studies of this type related to consumers.

The main findings confirm that surveyed individuals with a higher educational level are more likely to require EE in the service contract. The study has also revealed that people who feel like women are more likely to demand more accommodation services with EEU than men, as well as that this predisposition increases with the age of the respondents, with this probability stabilizing after 39 years of age. Figure 4 shows in summary the characterization of the consumers resulting from the study. The demographic profile most likely to demand more EEU in accommodation would be that of a person who considers themselves a woman, with a good level of training and over 39 years of age.

It should be noted that this study has certain limitations such as the hypothetical nature based on the stated preferences of the respondents. These types of hypothetical statements tend to be exaggerated and often do not translate into actual preferences or decisions. From this perspective, more studies conducted using non-hypothetical methods are needed to corroborate or refute these results.

## References

- Adongo, C. A., Taale, F., & Adam, I. 2018. Tourists' values and empathic attitude toward sustainable development in tourism. *Ecological Economics*, 150, 251-263.
- Candela, V., Rocio, R. Q., Oliver, W., Katherine, B., Tecla, C., & Jane, T. 2016. Revision of European Ecolabel Criteria for Tourist Accommodation and Campsite services. Final criteria proposal. European Commission, Brussels .2023. Flash Eurobarometer 535 (The EU Ecolabel). GESIS, Cologne. ZA8766 Data file Version 1.0.0.
- Laroche, M., Bergeron, J., & Barbaro-Forleo, G. 2001. Targeting consumers who are willing to pay more for environmentally friendly products. *Journal of Consumer Marketing*, 18(6).
- Peiró Signes, Á., Miret-Pastor, L., Tsiouni, M., Siggia, D., & Galati, A. 2023. Determinants of consumers' response to eco-labelled seafoods: The interaction between altruism, awareness and information demand. *Journal of Cleaner Production*, 433, 139758.
- Preziosi, M., Tourais, P., Acampora, A., Videira, N., & Merli, R. 2019. The role of environmental practices and communication on guest loyalty: Examining EU-Ecolabel in Portuguese hotels. *Journal of Cleaner Production*, 237.

## Conflict of Interest

The authors have declared that there is no conflict of interest.



Ötraf Mühitin Mühafizəsi və Turizm

**Gurbanova Fidan<sup>1\*</sup>, Khasayeva Sevinj<sup>2</sup>, Siracova Saida<sup>3</sup>**

<sup>1</sup>Doctor of Economic Philosophy, Teacher, Azerbaijan State Economic University, Faculty of Economics and Business, Department of Public administration and social innovations

<sup>2</sup>Senior Lecturer, Azerbaijan State Economic University, Faculty of Economics and Business, Department of Public administration and social innovations

<sup>3</sup>Teacher, Azerbaijan State Economic University Faculty of Economics and Business, Department of Public administration and social innovations

Özet

*Turizm, gelişiminde en çekici doğal alanlara odaklandığından doğa ve manzara üzerindeki etkisi ayındır. İnsan ve doğa arasındaki ilişkide kısmen eğlence ve turizm kullanımından kaynaklanan bazı kriz merkezleri, öncelikle peyzajın zaman içinde kirlenmesini yansıtıyor. Böyle bir olumsuz etki çok güçlü olduğunda peyzaj turistler için çekiciliğini kaybeder ve alanın seyahat ve rekreasyona uygun olumlu ve arzu edilen özellikleri yavaş yavaş ortadan kalkar. Ekolojik denge seviyesinin önemi, belirli bir turistik destinasyon seçimine ilişkin karar verme sürecindeki ana motivasyonların ölçeğinde giderek daha fazla ortaya çıkmaktadır. Makalede turizm gelişiminin belirli bir alan üzerindeki olumlu etkileri vurgulanmakta, öncelikle turizmin doğanın ve insan çevresinin korunmasındaki rolü vurgulanmakta, aynı zamanda turizmde çevre bilinci ve çevresel davranışlar ele alınmaktadır. Turizmdeki pazarlama faaliyetlerinin önemli bir kısmı, bozulmamış doğası ve temiz peyzajı olan destinasyonların giderek daha fazla vurgulanmasına yöneliyor, bu da çevrenin korunduğunu gösteriyor.*

**Anahtar Kelimeler:** Turizmin gelişmesi, çevre, doğa, ekoturizm, çevre kirliliği.

Environment Protection and Tourism

Abstract

*Since tourism is focused on the most attractive natural areas in its development, its impact on nature and landscape is the same. Some centers of crisis in the relationship between man and nature, driven in part by the use of leisure and tourism, primarily reflect the pollution of the landscape over time. When such a negative impact is too strong, the landscape loses its attractiveness for tourists, and the positive and desirable features of the area suitable for travel and recreation gradually disappear. The importance of the level of ecological balance is more and more evident in the scale of the main motives in the decision-making process for choosing a specific tourist destination. The article emphasizes the positive effects of tourism development on a certain area, first of all, the role of tourism in the protection of nature and human environment is emphasized, and at the same time, environmental awareness and environmental behavior are addressed in tourism. A significant part of marketing activities in tourism tends to emphasize more and more destinations with intact nature and clean landscapes, which indicates their environmental protection.*

**Keywords:** Tourism development, environment, nature, ecotourism, environmental pollution.

GİRİŞ

Turizmin gelişim görünümü, yeşil destinasyonlara yönelik eğilimleri göstermektedir ve gelecek, el değmemiş doğa ve temiz çevre sunan destinasyonların olacaktır. Doğanın, çevrenin ve değerlerinin turizm pazarında ürünü temsil ettiği açıktır. Çevre, alt sistemlerin, yani biyosferin, teknolojik ve sosyal alanın parçalarının etkileşimidir (Dukic, 2001). Turizm endüstrisi çevreyi belirli bir şekilde kullanır. Turizm ortamı için öncelikle doğal çevre ve kaynaklar dikkate alınır. Turizm faaliyetlerinin karmaşık sonuçları dört kategoriye ayrılabilir. Mekanik etkiler, yani toprağın sıkışması ve sertleşmesi, erozyon ve bitki örtüsünün tahrip edilmesi; peyzajda değişikliklere neden olan arazi alanlarının yoğun kullanımı;

hava, toprak ve su kirliliği; yakıt yanması, solvent buharlaşması, kimyasal sızıntı, atık; gürültü veya koku gibi rahatsız edici faktörler (Hahn, 1989). Turizmin doğasında bulunan doğal kaynakların kullanılması, başka türlü elde edilemeyecek ekonomik faydalar sağlar. Turizm destinasyonları giderek şehirlere benzemekte ve yığılma özellikleri kazanmaktadır.

Turizm, doğayı, macerayı, harikaları ve toplumları keşfetmek, kültürleri keşfetmek, insanlarla tanışmak, değerlerle etkileşimde bulunmak ve yeni gelenek ve olayları deneyimlemek için seyahati teşvik eden yaşayan bir güçtür. Turizm gelişimi, turizm endüstrisini geliştirmek ve sürdürmek için turistleri belirli bir destinasyona çeker. Ayrıca çevresel sürdürülebilirlik, insan sağlığını ve ekonomik refahı desteklerken ekolojik ekosistemleri korumak için sosyo-kültürel mirası ve doğal kaynakları korumaya yönelik geleceğe yönelik bilinçli bir çabadır. Çevresel sürdürülebilirlik, turistlerin motivasyon derecesini ve yerel toplulukların ziyaretçileri karşılama istekliliğini yansıtan temiz ve yeşil doğal manzaraya, gelişen biyolojik çeşitliliğe, deniz sahillerine, uzun çöllere, sosyo-kültürel değerlere ve arkeolojik mirasa yansıtılabilir. Bu bağlamda turizmin gelişmesi ve çevrenin sürdürülebilirliği birbirine bağlı yapılar olarak değerlendirilmekte, dolayısıyla turizmin gelişmesi ve turist gelişindeki artış sürdürülebilir ve yeşil turizmin kalitesini doğrudan etkilemektedir (Azam vd. 2018; Hassan ve diğerleri 2020)

### 1. Çevre sorunlarının turizme etkisi

Turistik destinasyonlardaki yerel kirlilik arasında hava emisyonları, gürültü, katı atıklar, çöpler, kanalizasyon, petrol ve kimyasallar, görsel kirlilik, ısı, araç kullanımı vb. yer almaktadır. dahil edilebilir. Ayrıca kontrolsüz, kalabalık ve kötü planlanmış turist nüfusu da çevre kalitesi üzerinde önemli olumsuz etkiler yaratmaktadır. Bu durum doğal kaynakların aşırı tüketimine, hizmet kalitesinin bozulmasına, atık ve kirliliğin katlanarak artmasına neden oluyor. Ayrıca turizmin kapasite fazlası, toprak erozyonu, doğal kaynakların tükenmesi, atık birikmesi ve hava kirliliği, biyolojik çeşitliliğin tehlikeye girmesi, sosyo-kültürel yaşam alanlarının parçalanması gibi sorunları da beraberinde getirmektedir. (Kostić ve diğerleri 2019; Andlib ve Salcedo-Castro 2021)

Dünyanın farklı bölgelerinde turizm gelişimi ve çevre kirliliği görülmektedir. Hava kirliliği, iklim değişikliği ve küresel ısınmanın cenneti olarak adlandırılan ASEAN ülkeleri ekonomik turizm ve kirlilikle karşı karşıyadır (Azam vd. 2018; Güzel ve Okumuş 2020). Çin'de elli sekizden fazla büyük Çin turizm destinasyonu, hava kirliliğini azaltmak ve çevresel sürdürülebilirliği iyileştirmek için acil politika eylemleri çağrısında bulunuyor (Zhang ve diğerleri, 2020). Benzer şekilde, en çok ziyaret edilen ülke olan Singapur, olumsuz çevresel ayak izleri ile karşı karşıyadır ve turizm gelişimi ile çevresel sürdürülebilirlik arasında bir denge kurulması çağrısında bulunmaktadır (Khoi ve ark. 2021). Önceki çalışmalar, uluslararası turizmin ve turizme bağlı büyümenin, turist gelişleri, enerji tüketimi, karbondioksit (CO<sub>2</sub>) emisyonları ve hava kirliliği yoluyla iklim değişikliğine katkıda bulunduğunu ortaya çıkarmıştır (Aslan ve ark. 2021). Güney Asya ülkeleri, özellikle Sri Lanka ve Pakistan, diğer ülkelerle karşılaştırıldığında turizmde büyümenin ve çevre kirliliğinin eşliğindedir (Chishti ve ark. 2020; Tiwari ve ark. 2021).

Turizmin genişlemesi, ev sahibi topluluklara sağladığı sosyo-ekonomik faydalar karşısında zararlı bir çevresel maliyet olarak tanımlanmıştır (Pulido-Fernández ve diğerleri 2019; Simo-Kengne 2022). Bu bağlamda çalışma Pakistan'ın turizm geliştirme faaliyetleri ile çevresel sürdürülebilirliği arasındaki ilişkileri incelemeyi amaçlamaktadır. Pulido-Fernández ve ark. (2019) ve Simo-Kengne (2022), Pakistan'ın turizm gelişimine olan bağlılığının devam etmesinin iki şekilde çevresel bozulmaya yol açacağından korkulmaktadır. Birincisi, turizm altyapısının geliştirilmesi süreci, hava ve su kirliliği, doğa ve biyolojik çeşitlilik kaybı şeklinde doğal kaynakları tüketecektir. İkincisi, turizmle ilişkili enerji tüketen faaliyetlerin çoğalması, CO<sub>2</sub> emisyonlarını artırarak çevreye zarar vermektedir. Bu nedenle, bölgedeki doğal ve sosyo-kültürel çevrenin sürdürülebilirliğinden ödün vermeden, turizm açısından zengin bu potansiyelden yararlanmak için Pakistan'ın turizm bölgelerini çevre dostu destinasyonlara



dönüştürmeye büyük ihtiyaç vardır.

Artan ticaret açığı seviyelerinde, Pakistan'ın zengin turizm potansiyeli, cari işlemler açığını dengelemek için gelir elde etmek için acil bir alternatif olarak görülüyor. Bununla birlikte, ortaya çıkan büyük ölçekli turizm endüstrisi, sürdürülebilir çevresel referanslara dayalı biyolojik çeşitlilik ticaretini tehdit eden ormansızlaşma, hava ve su kirliliğine yönelik bir tehdit olarak değerlendirilmektedir. Araştırma çalışması, turizmin gelişmesi ve büyümesine bağlı sosyo-ekolojik çevre sorunlarına kapsamlı ve kapsamlı bir cevap bulmayı amaçlamaktadır. Bu nedenle çalışma, Pakistan'da Sürdürülebilir Ekoturizmin gelişimi ve büyümesi için en çok ziyaret edilen destinasyonlarla birlikte bir model çerçevesi önermek üzere turizm gelişimi ile çevresel sürdürülebilirlik arasındaki ilişkiyi incelemektedir.

## 2. Ekoturizm

Turizmin gelişme süreci ve farklı dinamikleri ekoturizm, sürdürülebilir turizm, yeşil turizm veya yenileyici turizm vb.'dir. Belirli bir destinasyon veya alan için planlanan turizmin doğası etrafında döner. çevre, yerel halkın refahını sağlar ve yorumlama ve eğitimi içerir. Uluslararası Doğayı Koruma Birliği'ne (IUCN) göre ekoturizm, "Doğal alanlara yapılan, korumayı teşvik eden, ziyaretçiler üzerinde minimum etkiye sahip olan ve doğanın (ve ona eşlik eden hem geçmiş hem de şimdiki kültürel özelliklerin) tadını çıkaran ve takdir eden, çevreye duyarlı seyahattir. faydalı etkiler için tasarlanmıştır. yerel halkların aktif sosyo-ekonomik katılımı". Ayrıca Blangy ve Wood (1993) bunu "çevreyi koruyan ve yerel halkın refahını sağlayan, doğal alanlara yapılan sorumlu seyahat" olarak tanımlamıştır. Ekoturizm kavramı, "çevrenin korunması ve eğitimi, kültürel koruma ve deneyim ile ekonomik faydalar" dahil olmak üzere iyi tanımlanmış bir dizi ilkeye dayanmaktadır (Cobbinah, 2015: 179–189).

Ekoturizm, fiziksel, sosyal, etkileşimli ve psikosomatik etkilerin azaltılması da dahil olmak üzere, turizmin belirli bir destinasyonun turizm kaynakları üzerindeki etkisini en aza indirir. Ekoturizm aynı zamanda turistlerin ve ev sahiplerinin ekolojik ekosistemin tüm bileşenlerinin korunması ve korunması konusunda olumlu ve sorumlu bir tutum sergilemesiyle ilgilidir. Ekoturizm, yerel çevresel, politik veya sosyal konulara yüksek derecede hayırseverlik göstererek bir destinasyon için değer yaratmaktan ve sunmaktan sorumlu olan amaçlı bir düşünme biçimini temsil eder. Ekoturizm genel olarak kitle turizminden aşağıdaki özelliklerle farklılık gösterir:

- Vicdanlı davranış, düşük çevresel etkiye odaklanır.
- Yerel kültürlere, değerlere ve biyolojik çeşitliliğe duyarlılık ve sıcaklık.
- Yerel kaynakların korunmasına yönelik çalışmaların sürdürülmesine destek olmak.
- Turizm faydalarının yerel topluluklara dağıtılması ve ulaştırılması.
- Karar alma sürecine turizm paydaşı olarak yerel katılım.

Kötü organize edilmiş turizm ekosistemleri ve yerel kültürleri tehlikeye atabileceği ve önemli çevresel bozulmalara neden olabileceği için turistleri ve yerel halkı çevresel duyarlılık ve özen konusunda eğitmek.

Sürdürülebilirlik, turizmin tüm etkilerini tanımayı, olumsuz etkileri en aza indirmeyi ve olumlu etkileri en üst düzeye çıkarmayı amaçlamaktadır. Sürdürülebilir turizm, destinasyon içindeki ve çevresindeki turizm ortamının ekolojisine sürdürülebilir desteği sürdürmek için sürdürülebilir uygulamaları içerir. Sürdürülebilir turizm, ekoturizme benzer şekilde, marjinal etki yaratan seyahat fırsatları yaratmaya ve yerel toplumun refahı için düşük etkiye sahip, koruma ve değere sahip doğa hakkında bilgi edinmeye odaklanan ve kültürel faaliyetlere etkili katılımı teşvik eden doğal kaynak temelli bir turizmdir. . Bu nedenle ekoturizm sürdürülebilir turizmi içerirken, sürdürülebilir turizmin odak noktası aşağıdaki görevleri içerir:

Çevreye, doğal sermayeye, biyolojik çeşitliliğe ve yaban hayatına özen göstermek, korumak ve muhafaza etmek.

- Turistik destinasyonlarda ve çevresinde yaşayan insanların sosyo-ekonomik refahının sağlanması.
- Ziyaretçilerin öğrenme deneyimleri için kültürel ve tarihi mirasın belirlenmesi, restorasyonu,



korunması ve tanıtılması.

- Turistleri ve yerel grupları karşılıklı yarar sağlayacak şekilde bir araya getirmek.
- Turistler için geniş ve erişilebilir fırsatların yaratılması.
- Çevresel ve ekosistem sürdürülebilirliği.

### 3. Çevre

"Çevre" terimi, doğal, organik canlı, inorganik ve doğal olmayan tüm varlıkları kapsar. Çevre aynı zamanda her türlü solunumun doğal kaynaklarla ve çevrenin diğer bileşenleriyle olan ilişkisini de ifade eder. İnsanlar ve uluslar çevreyi kendi amaçlarına uyacak şekilde değiştirmeye çalıştıklarından, çevresel zararlardan büyük ölçüde insan faaliyetleri sorumludur. Ormansızlaşma, aşırı nüfus, doğal sermayenin tükenmesi, katı atıkların ve kanalizasyonun toplanması, hava ve suyun kirlenmesine, asit yağmurlarına, artan karbondioksit seviyelerine, ozon tabakasının incelmeye, iklim değişikliğine, küresel ısınmaya, küresel ısınmaya neden olan başlıca insan faaliyetleridir. türler vb. Temiz, yeşil ve hijyenik bir çevre, doğanın, canlıların onlara tasarladığı gibi insanların, hayvanların ve biyoçeşitliliğin sağlıklı yaşaması için temiz hava, temiz su, temiz enerji ve orta sıcaklığa sahiptir. Temiz bir çevrenin sürdürülmesi ve sürdürülmesi, insan ve biyolojik çeşitliliğin varlığı, iş yönetimi ve zenginlik yaratma açısından büyüme ve gelişmeyi teşvik etmek için gereklidir. Çevrenin korunması, temiz hava, su ve gıdanın toksik kirlilikten, atıklardan ve kanalizasyondan sağlanması ve nesli tükenmekte olan türlerin ve toprağın korunmasını sağlayacak koruma ve uygun yönetim yoluyla sağlanabilir.

Ülkeler arasında sosyo-ekonomik ortaklıklar kurmasıyla bilinen küreselleşme süreci aynı zamanda doğal kaynakların aşırı tüketimi ve enerji tüketimi, ormansızlaşma, toprak erozyonu ve bozulma yoluyla çevresel bozulmayı da teşvik etmektedir (Adebayo ve Kırıkkaleli 2021; Sun vd. 2021). Pakistan'da çevresel bozulmanın nedenselliğini araştırırken, CO<sub>2</sub> emisyonları ile GSYİH büyümesi, yenilenebilir enerji, teknolojik yenilik ve küreselleşme arasında önemli bir ilişkinin varlığını ampirik olarak doğruladı. Ancak Çin, CO<sub>2</sub> emisyonlarını kontrol etmek ve çevre kalitesini iyileştirmek için güneş enerjisini ekonomik müdahale kaynağı olarak kullanmayı önerdi. Mikroskobik hava kirlleticileri insanın solunum ve kardiyovasküler sistemlerini delerek akciğerlere, kalbe ve beyne zarar verdiği için hava kirliliğinin tehlikelerinden kaçınmak zordur. Plansız ve kontrolsüz insan faaliyetleri ekosistemleri olumsuz etkileyerek iklim değişikliğine, okyanus asitlenmesine, buzulların erimesine, habitat kaybına, ötrofikasyona, hava kirliliğine, kirleticilere ve nesli tükenmekte olan türlerin yok olmasına neden olmaktadır (Albrich K, Rammer W, Seidl R. 2020: 4013 –4027).

İnsanlar fiziksel çevrelerini kirlilik, kirlilik, aşırı nüfus, ormansızlaşma, fosil yakıtların yakılması ve toprak erozyonuna neden olması, hava ve su kalitesinin kirlenmesi, iklim değişikliği vb. gibi çeşitli şekillerde etkilemektedir. daha anlamlı bir etkiye sahiptir. Kalkınma ve Sürdürülebilir Kalkınma Hedefleri (SDG'ler), sağlıklı bir çevre ve insan sağlığının, yaşam, refah, gıda, su ve sanitasyon hakkı gibi temel insan haklarının hayata geçirilmesinin ayrılmaz parçaları olarak iç içe geçtiği yönündeki genel önermeyi yansıtmaktadır. kalite hakkı. Her yaşta sağlıklı yaşamlar sağlamak ve karasal ekosistemler (SDG15), okyanuslar (SDG14), şehirler (SDG11), su, sanitasyon ve hijyen (SDG6) dahil olmak üzere herkes için refahı (SDG3) teşvik etmek için yaşamı ve biyolojik çeşitliliği korumak. UNEP, gelişmekte olan ekonomilerdeki ishal vakalarının %58'inin temiz su eksikliği ve yetersiz sanitasyondan kaynaklandığını ve bunun dünya çapında 3,5 milyon ölümle sonuçlandığını belirtti.

### 4. İklim değişikliği

İklim değişikliği, ekosistemlerin su kalitesini korumak, su akışlarını düzenlemek, geçici hava dengesizlikleri ve buzulları korumak, biyolojik çeşitliliğin yer değiştirmesi veya kaybı, orman yangınları ve kuraklık gibi yaşamı tehdit eden olayları düzenleme yeteneğini büyük ölçüde değiştiriyor. Araştırmalar, doğal çevreye maruz kalmanın zihinsel sağlıkla bağlantılı olduğunu ve yeşil alana yakınlığın stresi azaltma, depresyon ve kaygıyı en aza indirmeyle ilişkili olduğunu öne sürüyor. Ayrıca

Ekosistem kirlilikten, doğal kaynakların aşırı tüketiminden, iklim değişikliğinden, istilacı ve yerinden edilmiş türlerden vb. etkilenir. etkilemek. Dolayısıyla temiz hava ve suyun, hijyenik mekanların ve yeşilliklerin sağlanması yaşam kalitesini zenginleştirir: Ölüm oranlarının azalması, daha sağlıklı katma değerli üretkenlik ve ruh sağlığının korunması için hayati önem taşır. Öte yandan iklim değişikliği karasal ekolojii, okyanusları, biyolojik çeşitliliği, tatlı ve temiz suya erişimi olumsuz etkileyerek çevre sağlığı tehlikelerini artırıyor.

Turizm gelişimi, destinasyon içinde ve çevresinde turistlere hizmet veren tesislerin oluşturulması ve işlenmesi ile ilgili tüm faaliyetleri ifade etmektedir. Altyapı geliştirme, turistlerin yaşam koşullarını iyileştirmeyi ve yeni turistik tesisler, topluluk yaşamı da dahil olmak üzere destinasyonların idari ve yardımcı kademelerini oluşturmayı amaçlamaktadır. Doğal ve kültürel mirasın yapılaştırılarak korunması turizm destinasyonunun gelişimi açısından oldukça önemlidir. Turizm altyapısının gelişmesi ve arazi kullanımı çoğu zaman doğal yüklerle neden olmaktadır. Sermayenin aşırı tüketimi toprak erozyonuna, kirliliğin artmasına, doğal yaşam alanlarının kaybına ve nesli tükenmekte olan türlere yol açmaktadır. Turizm altyapısı geliştirme ve inşaat faaliyetleri, çevresel bozulma, yeşillik kaybı, ormansızlaşma, katı atık ve kanalizasyon, hava ve suyun aşırı kullanımı, hava ve su kirliliğine neden olan CO<sub>2</sub> ve diğer gazların emisyonu, iklim değişikliği, kayıp ve hasarlar üzerinde ciddi etkiye sahiptir. . Biyolojik çeşitliliğin yer değiştirmesi ve ekosistemlerin bozulması. Turizm gelişiminin bu olumsuz sonuçları, yakın gelecekte turistler ve yerel halk için birçok sorunun ortaya çıkmasına neden olacaktır (Azam M, Alam MM, Hafeez MH. ,2018: 330–338; Hoang TTH,2020: 1371–1395).

UNEP tarafından yayımlanan İklim Eylemi Altyapısı raporu, iklim değişikliğini hafifletme, uyum ve hafifletme çabalarında tüm sera gazı emisyonlarının %79'unu baskın altyapı oluşturduğundan hükümetlerin sürdürülebilir altyapı uygulamasını tavsiye ediyor. Sürdürülebilir altyapı, yapıların planlanması, inşası ve işletilmesinin sosyal, ekonomik ve ekolojik sistemlere zarar vermemesi anlamına gelir (UNEP 2021; Krampe, 2021: 1159–1172). Sürdürülebilir altyapı toplumların, doğanın ve çevrenin birlikte gelişmesini sağlayacak tek çözümdür. Bu nedenle Sürdürülebilir Ekoturizm, iklim değişikliğini etkileyecek şekilde sürdürülebilir biyolojik çeşitliliğe ve ekosistemlere katkıda bulunan çevresel ve doğa temelli iklim değişikliği stratejilerinin uyarlanmasını desteklemektedir. Önerilen strateji, iklim tehlikeleri, değişken yağışlar, toprak erozyonu, sıcaklık değişiklikleri, seller ve aşırı rüzgar fırtınalarıyla mücadele etmek için ekosistemlerin korunmasına ve onarılmasına odaklanmaktadır (Niedziółka, 2014: 157–166; Setini, 2021: 595–608).

## SONUÇ

Turizm bölgelerinde altyapının yeniden canlandırılması ve restorasyonu, yoğun ormansızlaştırma, yerel yeşillik kullanımı, yol ağının yeniden inşası, biyolojik çeşitliliğin yer değiştirmesi ve su ve diğer doğal kaynakların aşırı tüketimi ile desteklenmiştir. Ormansızlaşma, yeşilliklerin aşırı kullanımı, su ve diğer doğal kaynakların aşırı tüketimi bir yandan bölgenin turizm değerini düşürürken, diğer yandan çevreyi bozmuştur. Ağaç dikme programının sosyo-çevresel koruma stratejisi, turizmin ağırlıklı olduğu alanları kapsıyordu. Bu çabalar sayesinde ormansızlaşma ve yeşil alanların kaybı onarılıyor ve turizm ortamının yakın zamanda toparlanması bekleniyor.

## Kaynaklar

TS, Kirikkaleli D. Impact of renewable energy consumption, globalization, and technological innovation on environmental degradation in Japan: application of wavelet tools. *Environ Dev Sustain.* 2021;23(11):16057–16082. doi: 10.1007/s10668-021-01322-2. [[CrossRef](#)] [[Google Scholar](#)]

Albrich K, Rammer W, Seidl R. Climate change causes critical transitions and irreversible alterations of mountain forests. *Glob Change Biol.* 2020;26(7):4013–4027. doi: 10.1111/gcb.15118. [[PMC free article](#)] [[PubMed](#)] [[CrossRef](#)] [[Google Scholar](#)]

**V. INTERNATIONAL APPLIED STATISTICS CONGRESS (UYIK - 2024)**  
**İstanbul / Türkiye, May 21-23, 2024**

---

- Aslan A, Altinoz B, Özsolak B. The nexus between economic growth, tourism development, energy consumption, and CO<sub>2</sub> emissions in Mediterranean countries. *Environ Sci Pollut Res*. 2021;28(3):3243–3252. doi: 10.1007/s11356-020-10667-6. [[PubMed](#)] [[CrossRef](#)] [[Google Scholar](#)]
- Azam M, Alam MM, Hafeez MH. Effect of tourism on environmental pollution: further evidence from Malaysia, Singapore and Thailand. *J Clean Prod*. 2018;190:330–338. doi: 10.1016/j.jclepro.2018.04.168. [[CrossRef](#)] [[Google Scholar](#)]
- Chishti MZ, Ullah S, Ozturk I, Usman A (2020) Examining the asymmetric effects of globalization and tourism on pollution emissions in South Asia. *Environ Sci Pollut Res* 27(22):27721–27737 [[PubMed](#)]
- Cobbinah PB. Contextualizing the meaning of ecotourism. *Tour Manag Perspect*. 2015;16:179–189. doi: 10.1016/j.tmp.2015.07.015. [[CrossRef](#)] [[Google Scholar](#)]
- Khoi NH, Le NH, Ngoc BH (2021) The effect of tourism development on the ecological footprint in Singapore: evidence from asymmetric ARDL method. *Curr Issue Tour* 25(15):2500–2517
- Kostić M, Milićević S, Nedeljković I. Research of tourists' perception of the relationship between tourism and environment. *Вестник анк Ставропољья* 2016;S4:32–35. [[Google Scholar](#)]
- Niedziółka I. Sustainable tourism development. *Reg Form Dev Stud*. 2014;8(3):157–166. [[Google Scholar](#)]
- Pulido-Fernández JI, Cárdenas-García PJ, Espinosa-Pulido JA. Does environmental sustainability contribute to tourism growth? An analysis at the country level. *J Clean Prod*. 2019;213:309–319. doi: 10.1016/j.jclepro.2018.12.151. [[CrossRef](#)] [[Google Scholar](#)]
- UNEP (2021) New report reveals how infrastructure defines our climate. October, 12
- Zhang N, Ren R, Zhang Q, Zhang T. Air pollution and tourism development: an interplay. *Ann Tour Res*. 2020;85:103032. doi: 10.1016/j.annals.2020.103032. [[CrossRef](#)] [[Google Scholar](#)]





## A Deep Dive into the Support Vector Machines and Their Applications in Natural Sciences

**Uğurcan Demir<sup>1\*</sup>, Onur Köksoy<sup>1</sup>**

<sup>1</sup>Ege University, Department of Statistics, 35040, İzmir, Türkiye

\*Corresponding author e-mail: ugur.can.demir@hotmail.com

### *Abstract*

*Support Vector Machines (SVMs) have emerged as powerful tools in machine learning, finding extensive applications across various domains due to their ability to handle both classification and regression tasks effectively. In this presentation, we delve into the significance of SVMs and give some important examples. We discuss the mathematical foundation of Support Vector Machines by providing a solid framework for understanding their underlying principles. By exploring the mathematical properties of SVMs, we clarify their core concepts, including margin optimization and the kernel trick. This mathematical exposition equips researchers and practitioners with a deeper comprehension of SVMs, enabling more informed model selection and parameter tuning strategies. We close by giving some applications of Support Vector Machines in natural sciences, where the accurate analysis of complex data plays a pivotal role. We present compelling case studies that illustrate the power of SVMs in real-world scenarios. By harnessing the predictive power of SVMs, researchers in natural sciences can glean valuable insights from complex datasets.*

**Keywords:** Support Vector Machines , Kernal Trick , Loss Functions , Model Optimization , Statistical Learning Theory

### **INTRODUCTION**

Machine learning, a subfield of artificial intelligence, has revolutionized the way we approach problem-solving across diverse domains. By leveraging algorithms that can learn patterns and make data-driven predictions, machine learning has become an indispensable tool in fields ranging from finance and healthcare to image recognition and natural language processing. One of the well-known members of this machine learning revolution is the Support Vector Machine (SVM), a powerful and versatile algorithm renowned for its ability to tackle complex problems with remarkable efficacy.

In the area of machine learning, SVMs stand out as formidable tools capable of handling both classification and regression tasks. The significance of SVMs extends beyond their capacity to simply make predictions; they excel in scenarios where the relationships within the data are intricate and nonlinear. The elegance of SVMs lies in their ability to transform complex data into a higher-dimensional space, making them good at discerning intricate patterns that might outperform other algorithms.

While it is open for debate, (Vapnik, 1968) is accepted as the birth of Support Vector Machines. Later on, the emergence of support vector machines in the 1990s , (Cortes & Vapnik, 1995), marked a pivotal moment in the evolution of machine learning. Developed by Vladimir Vapnik and his colleagues, SVMs introduced a novel approach to supervised learning, departing from traditional statistical methods and opening a new era of classification and regression algorithms. Support Vector Machines (SVMs) represent a category of machine learning algorithms rooted in mathematical optimization and statistical learning theory. At their core, SVMs aim to identify a hyperplane that best separates data into distinct classes or predicts a continuous outcome. (Vapnik, 1999) gives a very concise and sufficient overview of these.

Support vector machines (SVMs) are a powerful family of supervised learning algorithms that have proven to be remarkably effective in a wide range of applications, including classification, regression, and outlier detection. So, to comprehend the dynamics of SVMs, it is essential to grasp their theoretical foundations. At the heart of SVMs lies the concept of finding an optimal hyperplane, which is a decision boundary that separates two classes of data points with the maximum margin. (Vapnik, 1998) and (Vapnik, 1995) explain the importance of these concepts in a clear and rigorous way.

Going further about the concept of optimal hyperplane, it is a decision boundary that effectively separates two classes of data points. The remarkable aspect of SVMs comes from their ability to maximize the margin, the distance between the hyperplane and the closest data points from each class, known as support vectors. This margin-maximization principle ensures that SVMs generalize well to unseen data, achieving robust classification performance.

### **THEORY AND MOTIVATION**

To find the optimal hyperplane in Support Vector Machines (SVMs), we formulate the problem as an optimization task.

The optimization problem displayed above is the final product of a long reasoning. Here we build up our study and start from scratch. Let's start with a binary classification scenario where we have two classes, denoted by  $y_i \in \{-1, +1\}$ , and feature vectors  $x_i$  for  $i=1, 2, \dots, n$ .

Support Vector Machines can be generalized in to more than two classes but for the sake of simplicity we will stick with binary classification setting.

The decision function for a linear SVM is defined as:

$$f(x) = w \cdot x + b \tag{2.1}$$

where  $w$  is the weight vector perpendicular to the hyperplane,  $b$  is the bias term,  $x$  is the feature vector.

The classification rule is based on the sign of  $f(x)$ . If  $f(x) > 0$  the data point is classified as  $+1$ , and if  $f(x) < 0$ , the data point is classified as  $-1$ .

To ensure that the hyperplane effectively separates the classes, we introduce the concept of a margin. The margin is the distance between the hyperplane and the nearest data point from either class. Mathematically, for a given data point  $(x_i, y_i)$ , the margin ( $\xi_i$ ) is given by:

$$\xi_i = \frac{y_i(w \cdot x_i + b)}{\|w\|} \tag{2.2}$$

The goal is to maximize the margin while correctly classifying each data point. This leads to the following optimization problem:

$$\text{Maximize } \frac{1}{\|w\|} \text{ subject to } y_i(w \cdot x_i + b) \geq 1 \text{ for } i = 1, 2, \dots, n \tag{2.3}$$

The Lagrangian formulation of the above optimization problem involves introducing Lagrange multipliers ( $\alpha_i$ ):

$$L(w, b, \alpha) = \frac{1}{2} \|w\|^2 + C \sum_{i=1}^n \alpha_i (1 - y_i(w \cdot x_i + b)) \tag{2.4}$$

The Karush-Kuhn-Tucker (KKT) conditions for optimality include:

$$\alpha_i \geq 0 \tag{2.5}$$

$$y_i(w \cdot x_i + b) - 1 + \xi_i \geq 0 \tag{2.6}$$

$$\alpha_i (y_i(w \cdot x_i + b) - 1 + \xi_i) = 0 \tag{2.7}$$

The expression  $\frac{1}{2} \| w \|^2$  in (2.4) is the regularization term that penalizes the complexity of the model,  $C$  is a regularization parameter controlling the trade-off between achieving a low training error and a large margin. Also, more detailed explanation about the mathematical side of the optimization process can be found in (Suthaharan, 2016).

As we encounter datasets with non-linear relationships, the kernel trick becomes a valuable tool in the SVM toolbox. The kernel trick allows us to implicitly map data into higher-dimensional spaces without explicitly calculating the transformed feature vectors. This technique enhances the expressive power of SVMs, enabling them to handle complex patterns (Bishop, 2006). Also the traditional SVMs aim to maximize the margin and ensure correct classification, incorporating loss functions into the optimization allows for a more flexible approach. This modification is particularly useful when dealing with noisy or overlapping datasets (Hastie et al., 2009).

**Table 1.** Some Commonly Used Kernel and Loss Functions

Loss Functions	Kernel Functions
<b>Hinge Loss</b> Hinge Loss( $y, f(x)$ ) = $\max(0, 1 - y \cdot f(x))$	<b>Linear Kernel</b> $K(x, x') = (x^T \cdot x' + c)^d$
<b>Squared Hinge Loss</b> Squared Hinge Loss( $y, f(x)$ ) $= \max(0, 1 - y \cdot f(x))^2$	<b>Polynomial Kernel</b> $K(x, x') = (x^T \cdot x' + c)^d$
<b>Epsilon-Insensitive Loss</b> Epsilon-Insensitive Loss( $y, f(x)$ ) $= \max(0,  y - f(x)  - \epsilon)$	<b>Radial Basis Function (RBF) Kernel</b> $K(x_i, x_j) = \exp\left(-\frac{\ x_i - x_j\ ^2}{2\sigma^2}\right)$
<b>Logistic Loss</b> Logistic Loss( $y, p$ ) $= -(y \cdot \log(p) + (1 - y) \cdot \log(1 - p))$	<b>Sigmoid Kernel</b> $K(x, x') = \tanh(\alpha \cdot x^T \cdot x' + c)$

## APPLICATIONS

### Medical Image Processing

Identifying and delineating tumor regions in magnetic resonance (MR) imaging is a critical task because early diagnosis of it can lead to higher times of survival rates according to (Coatrieux et al., 2013). Yet this labor-intensive process predominantly depends on the skill and experience of radiologists or clinical experts. Given the inherent variability stemming from individual practitioner experience, the adoption of computer-aided technologies is crucial for enhancing consistency and efficiency in these diagnostic tasks. These technological solutions can significantly overcome challenges, ensuring more reliable and swift tumor detection and analysis.

In their research, (Bahadure, Ray, & Thethi, 2017) focused on improving the medical image segmentation process by integrating the Berkeley wavelet transformation (BWT) for precise brain tumor segmentation. They enhanced the accuracy and effectiveness of support vector machine (SVM) classifiers through detailed feature extraction from each segmented tissue. Utilizing MR images, they categorized brain tissues into distinct types such as white matter, gray matter, cerebrospinal fluid, and tumor-infected tissues. The study covered fifteen patients diagnosed with glial tumors at various stages, from benign to malignant. To optimize image quality, they used preprocessing techniques aimed at boosting the signal-to-noise ratio and minimizing extraneous noise, while a threshold-based skull stripping algorithm was implemented to refine the segmentation performance further.



Moreover, the researchers utilized the Berkeley wavelet transform for image segmentation and deployed a support vector machine to accurately determine the stage of the tumor by analyzing feature vectors and the size of the tumor area. They explored both texture-based and histogram-based features, employing a widely acknowledged classifier to diagnose brain tumors from MR images. Their experimental results, conducted across a variety of images, revealed that this method significantly accelerates the detection process and enhances accuracy when compared to traditional manual techniques used by radiologists or clinical experts.

**Table 2.** Performances of Different Models on Brain MR Images from (Bahadure, Ray, & Thethi, 2017)

Evaluation parameter	ANFIS	Back Propagation	Proposed classifier (SVM)	K-NN
True negative	63	62	65	63
False positive	16	19	4	18
True positive	118	110	129	112
False negative	4	10	3	8
Specificity (%)	79.74	76.54	94.2	77.77
Sensitivity (%)	96.72	97.5	97.72	93.33
Accuracy (%)	90.04	85.57	96.51	87.06

The researchers' method underwent thorough evaluation and validation through MR brain imaging, assessing crucial performance indicators like accuracy, sensitivity, specificity, and the Dice similarity coefficient. Their experimental findings showcased remarkable performance metrics, with accuracy reaching 96.51%, specificity at 94.2%, and sensitivity at 97.72%, emphasizing the technique's capability to accurately differentiate between normal and abnormal brain tissues. Furthermore, the Dice similarity coefficient, averaging 0.82, reflected a substantial correspondence between the tumor regions extracted by the machine and those manually delineated by medical professionals. These results not only demonstrated the efficacy of their approach but also affirmed its potential for incorporation into clinical decision support systems, aiding radiologists and clinical experts in primary screening and diagnostic processes.

The results from the study not only affirm the superiority of the proposed technique in quality and accuracy over current methods but also underscore its potential to enhance medical imaging processes significantly. The analysis demonstrated improvements across various performance metrics, including mean values, mean square error (MSE), peak signal-to-noise ratio (PSNR), accuracy, sensitivity, specificity, and the Dice coefficient. Such enhancements suggest that the approach not only facilitates accurate and timely detection of brain tumors but also aids in precisely identifying their locations. Consequently, this method represents a substantial advancement in the detection of brain tumors using MR imaging, promising to refine diagnostic practices and improve patient outcomes.

### Energy Forecasting

With the rapid growth of urban populations and technological progress, the demand for electrical power in buildings is escalating. This increase underscores the need for sophisticated energy management strategies, where precise energy forecasting becomes crucial. The study being reviewed, (Ahmad et al., 2014), delves into the use of artificial intelligence techniques, specifically support vector machines (SVM) and artificial neural networks (ANN), to accurately predict electrical energy consumption in urban buildings. The authors argue that these so-called engineering approaches are more accurate and flexible than the so-called statistical approaches by basing this opinion to (Zhao & Magoulès, 2012). This approach aims to optimize energy use and enhance sustainability in rapidly developing urban environments.

These methods are widely recognized and continuously refined within the field of predictive analytics, aimed at improving the accuracy of forecasts. Additionally, the research investigates a pioneering hybrid approach that merges the advantages of various forecasting methods. This innovative strategy specifically involves the integration of the Group Method of Data Handling (GMDH) and the Least Square Support Vector Machine (LSSVM), collectively known as GLSSVM. This combination is designed to enhance the precision of predictions regarding building energy requirements, promising more effective and efficient energy management solutions.

This study explores the application of Artificial Intelligence (AI) in forecasting energy consumption within buildings, a method that is increasingly attracting attention for its capacity to manage the intricate dynamics of systems affected by various building parameters. It emphasizes the widespread adoption of Neural Networks and Support Vector Machines as the leading models among researchers aiming to improve the precision of energy forecasts. These tools are renowned for their effectiveness in navigating the complexities of predictive analytics in building management, making them pivotal in advancing the accuracy of energy consumption predictions.

**Table 3.** Forecasting Results of two Different River Flows in Malaysia from (Ahmad et al., 2014)

Model	Selangor River				Bernam River			
	Training		Testing		Training		Testing	
	RMSE	R	RMSE	R	RMSE	R	RMSE	R
ARIMA	0.0914	0.7055	0.1226	0.5487	0.1049	0.7098	0.1042	0.5842
ANN	0.1065	0.5727	0.1092	0.6219	0.0602	0.9149	0.0709	0.8656
GMDH	0.1101	0.6733	0.1034	0.5850	0.0578	0.9216	0.0853	0.8387
LSSVM	0.0961	0.6747	0.1126	0.6269	0.0579	0.9319	0.0621	0.8727
GLSSVM	0.0853	0.7544	0.1123	0.6398	0.0290	0.9808	0.0642	0.8761

Given the distinct advantages and limitations inherent to each forecasting model, selecting the optimal method can be complex. Nevertheless, a combination of multiple models often leads to improved overall forecasting performance. This review introduces a hybrid model that merges the Group Method of Data Handling (GMDH) with the Least Square Support Vector Machine (LSSVM), termed GLSSVM. This innovative approach leverages the proven success of these methods in other time-series forecasting scenarios to potentially enhance accuracy. The effectiveness of the GLSSVM is rigorously evaluated through a detailed analysis of its application to building electrical energy consumption. The precision of this hybrid model is meticulously assessed using error analysis metrics such as the Root Mean Square Error (RMSE) and correlation coefficient. Furthermore, the performance of GLSSVM is

benchmarked against traditional single-method approaches like GMDH, LSSVM, and ANN, providing a comprehensive validation of its superior forecasting capabilities.

### Environmental Science

Drought represents a major natural disaster with profound negative impacts on the environment and agricultural productivity. Coupled with other natural phenomena such as climate change, earthquakes, storms, floods, and landslides, the urgency for robust predictive tools becomes paramount. The research detailed in this paper centers on the utilization of artificial intelligence to forecast drought conditions effectively. It evaluates and compares the capabilities of various AI techniques, including Artificial Neural Networks (ANN), Adaptive Neuro-Fuzzy Interface System (ANFIS), and Support Vector Machines (SVM), in accurately predicting the onset and severity of droughts.

For this analysis, (Mokhtarzad et al., 2017) uses the Standardized Precipitation Index (SPI) as the key metric, which was first proposed by (McKee et al., 1993), offering a quantitative assessment of deviations in precipitation levels. The study examines data collected over a nearly three-decade span, from January 1984 to December 2012, at the Bojnourd meteorological station, using a three-month temporal scale for granularity. Input parameters such as temperature, humidity, and seasonal precipitation were scrutinized, with the SPI employed as the crucial output parameter to gauge and interpret the data effectively. The findings from this study highlight the high accuracy of these models, particularly noting that the SVM model yielded the most precise forecasts. Additionally, using nonparametric inference for method comparison, the results further confirmed that the SVM model surpassed both ANN and ANFIS in forecasting accuracy.

**Table 4.** The Outputs of the Models for SPI from (Mokhtarzad et al., 2017)

Model	Num. of Data	R	K-S Test
ANN	15% of data	<b>0.9237</b>	<b>0.227</b>
ANFIS	15% of data	<b>0.9926</b>	<b>0.906</b>
SVM	15% of data	<b>0.9974</b>	<b>0.9303</b>

The findings from this study demonstrate that the models tested exhibit low error rates and deliver high accuracy in predicting drought conditions. Notably, the Support Vector Machine (SVM) model recorded a regression coefficient of 0.9974, indicating its robust applicability beyond the initial test environment to other meteorological stations. The superior flexibility and precision of the SVM model further highlight its effectiveness as a versatile tool for both simulating and forecasting various environmental scenarios.

Critical meteorological variables such as precipitation, temperature, and humidity play a pivotal role in enhancing the accuracy of these predictive models. The precision of these forecasts is further validated through the use of the 2-sample Kolmogorov-Smirnov (K-S) test, which affirms the superiority of the Support Vector Machine (SVM) approach. With a p-value of 0.9303, the SVM model demonstrates a significantly higher level of accuracy compared to the Artificial Neural Networks (ANN) and the Adaptive Neuro-Fuzzy Interface System (ANFIS). This statistical evidence strongly supports the effectiveness of the SVM model, showcasing its reliable performance relative to the other methodologies evaluated.

### CONCLUSION

Support Vector Machines (SVM) have proven to be incredibly versatile and useful across a broad spectrum of applications in the natural sciences. Their inherent flexibility allows them to be easily extended and modified, accommodating the specific needs of diverse research domains. From enhancing



the accuracy of drought forecasts to improving the detection of brain tumors and optimizing energy management systems, SVMs demonstrate a remarkable capacity to handle complex and varied datasets with high efficiency. This adaptability not only underscores the robustness of SVMs as a tool but also highlights their vast potential in contributing to advancements in scientific research and practical applications. As we continue to push the boundaries of what's possible with machine learning, SVMs are poised to play a pivotal role in shaping the future of data-driven discovery in the natural sciences.

## References

- Vapnik, V. (1968). On the uniform convergence of relative frequencies of events to their probabilities. In *Doklady Akademii Nauk USSR* (Vol. 181, No. 4, pp. 781-787).
- Cortes, C., & Vapnik, V. (1995). Support-vector networks. *Machine Learning*, 20(3), 273-297.
- Vapnik, V. N. (1999). An overview of statistical learning theory. *IEEE transactions on neural networks*, 10(5), 988-999.
- Vapnik, V. (1998). *Statistical Learning Theory*. Wiley.
- Vapnik, V. N. (1995). *The Nature of Statistical Learning Theory*. Springer.
- Suthaharan, S. (2016). Support Vector Machine. In *Machine Learning Models and Algorithms for Big Data Classification: Thinking with Examples for Effective Learning* (pp. 207-235). Springer US. [https://doi.org/10.1007/978-1-4899-7641-3\\_9](https://doi.org/10.1007/978-1-4899-7641-3_9)
- Bishop, C. M. (2006). Pattern recognition and machine learning. *Springer google schola*, 2, 1122-1128.
- Hastie, T., Tibshirani, R., Friedman, J. H., & Friedman, J. H. (2009). *The elements of statistical learning: data mining, inference, and prediction* (Vol. 2, pp. 1-758). New York: springer.
- Coatrieux, G., Huang, H., Shu, H., Luo, L., & Roux, C. (2013). A watermarking-based medical image integrity control system and an image moment signature for tampering characterization. *IEEE journal of biomedical and health informatics*, 17(6), 1057-1067.
- Bahadure, N. B., Ray, A. K., & Thethi, H. P. (2017). Image analysis for MRI based brain tumor detection and feature extraction using biologically inspired BWT and SVM. *International journal of biomedical imaging*, 2017.
- Ahmad, A. S., Hassan, M. Y., Abdullah, M. P., Rahman, H. A., Hussin, F., Abdullah, H., & Saidur, R. (2014). A review on applications of ANN and SVM for building electrical energy consumption forecasting. *Renewable and Sustainable Energy Reviews*, 33, 102-109.
- Zhao, H. X., & Magoulès, F. (2012). A review on the prediction of building energy consumption. *Renewable and Sustainable Energy Reviews*, 16(6), 3586-3592.
- Mokhtarzad, M., Eskandari, F., Jamshidi Vanjani, N., & Arabasadi, A. (2017). Drought forecasting by ANN, ANFIS, and SVM and comparison of the models. *Environmental earth sciences*, 76, 1-10.
- McKee, T. B., Doesken, N. J., & Kleist, J. (1993, January). The relationship of drought frequency and duration to time scales. In *Proceedings of the 8th Conference on Applied Climatology* (Vol. 17, No. 22, pp. 179-183).

## Derin Öğrenme Tekniği Kullanılarak LSTM Algoritmaları ile İklim Verilerinin Tahmin Edilmesi

**Ali HAS<sup>1\*</sup>, Şeyma GÜLER<sup>2</sup>**

<sup>1</sup>Doğuş Üniversitesi, Meslek Yüksekokulu, İnşaat Bölümü, 34775, İstanbul, Türkiye

<sup>2</sup>Bolu Köroğlu Yapı Denetim Ltd. Şti, 14100, Bolu, Türkiye

\*Sorumlu yazar e-mail: ahas@dogus.edu.tr

### Özet

*Bu çalışmada, Bolu ili merkezi için Meteoroloji Genel Müdürlüğünden alınan yağış, nem, güneşlenme süresi ve sıcaklık verileri kullanarak, derin öğrenme LSTM algoritmaları ile yağış, nem, güneşlenme süresi ve sıcaklık tahmini yapılmıştır. Eğitim için 495 aylık, onaylama ve test için 212 aylık veriler kullanılmıştır. Kullanılan verileri kullanılan fonksiyona göre verimli veriler elde etmek için normalleştirilmiştir. Her veri seti için ayrı ayrı 1 giriş ve 1 çıkış verisi olacak şekilde ağ modeli oluşturulmuştur. Eğitilen ağda Bolu İli için 2020'den sonraki 212 ayın verileri tahmin edilmiştir. Tahmin edilen veriler Aydeniz indeksinde yerine konularak kuraklık indeksi sınıflandırılması yapılmıştır.*

**Anahtar Kelimeler:** Yapay sinir ağları, Tahmin, LSTM, Derin öğrenme, Matlab

### GİRİŞ

Küreselleşme ile birlikte Günümüz dünyasının başlıca endişelerinden biri su kaynaklarının azalması olmaktadır. Su kaynaklarının kullanımına dair gerekli önlemlerin alınabilmesi için geçmiş dönem verilerinden de faydalanarak gelecekte olası karşılaşılabilecek kurak dönemlerin belirlenmesi gerekmektedir.

Kurak dönemlerin belirlenmesi için klasik yöntemlerin yanı sıra gelişen teknoloji ve bilimsel çalışmalar ile Yapay sinir ağları da kullanılmaya başlanmıştır. Yapay sinir ağları öncelikle hava sıcaklığı gibi iklim verilerini tahmininde kullanılmıştır (Kumaş, Ayan, Akyüz, Güngör, 2020). Aylık buharlaşma vb. diğer verilerde yapay sinir ağları ile tahmin edilmiştir (Özel, Büyükyıldız, 2019). Veriler ile farklı yöntemler geliştirilmiştir (Taşar, Üneş, Demirci, Kaya, 2018). İklim verilerinin tahmini ile beraber kuraklık tahminleri de yapay sinir ağları ile tahmin edilmeye çalışılmıştır (Gümüş, Başak, Yenigün, 2018). Çalışmalar Adıyaman, Şanlıurfa gibi illerde örnek modeller ile geliştirilmiştir (Tuhane, Dabanlı, Özbeyaz, 2019). Yapay sinir ağları ile yapılan çalışmalar devam ederken verilerin daha doğru ve uzun zamanlı tahminler yapılabilmesi için derin öğrenme metodu ile ilgili çalışmalar yapılmıştır.

Derin öğrenme, insan beyninin karmaşık problemler için gözlemlene, analiz etme, öğrenme ve karar verme gibi yeteneklerini taklit eden, denetimli veya denetimsiz olarak özellik çıkarma, dönüştürme ve sınıflandırma gibi işlemleri büyük miktarlardaki verilerden yararlanarak yapabilen bir makine öğrenmesi tekniğidir. (Kayaalp, Süzen, 2018)

Uzun Kısa Vadeli Hafıza Ağları — genellikle “LSTM’ler” olarak adlandırılır — uzun vadeli bağımlılıkları öğrenebilen özel bir RNN türüdür. Bunlar Hochreiter & Schmidhuber (1997) tarafından tanıtıldı ve aşağıdaki çalışmalarda pek çok kişi tarafından atıf aldı ve yaygınlaştırıldı. Çok çeşitli sorunlar üzerine muazzam derecede çalışırlar ve şu anda yaygın olarak kullanılmaktadırlar. LSTM’ler, uzun vadeli bağımlılık sorununun önüne geçmek için açıkça tasarlanmıştır. Uzun süre bilgi hatırlamak pratikte varsayılan davranışlarıdır, öğrenmek için uğraştıkları bir şey değildir. Tüm tekrarlayan sinir ağları, tekrar eden sinir ağı modül zinciri biçimindedir. Standart RNN’lerde, bu yinelenen modül, tek bir tanh katmanı gibi çok basit bir yapıya sahip olacaktır.

Bu çalışmada Bolu ilinin 1960-2020 yılları arasındaki mevcut aylık ortalama yağış, nispi nem, sıcaklık ve güneşlenme süreleri derin öğrenme LSTM kullanılarak 2020-2036 arasındaki verilerin

tahmini yapılmıştır. Yapay sinir ağının eğitilmesi, test ve tahmin işlemleri Matlab'de yapılmıştır.

## LSTM ve AYDENİZ KURAKLIK İNDİSİ

### LSTM

#### Uzun - Kısa Vadeli Hafıza (LSTM) Algoritmaları

Uzun Kısa Vadeli Hafıza (LSTM), zaman serilerini işlemek için özel olarak tasarlanmış bir tür tekrarlayan sinir ağıdır (RNN). Geleneksel RNN'ler, kısa vadeli bellek için oldukça etkilidir, ancak zamanla ortaya çıkan sorunlara karşı dirençli değildirler. Bu sorun, RNN'lerin uzun vadeli bağımlılıkları öğrenme yeteneğinin sınırlı olmasıdır.

LSTM, bu uzun vadeli bağımlılıkları öğrenme sorununu çözmek için geliştirilmiştir. 1997'de Hochreiter ve Schmidhuber tarafından tanıtılan LSTM, geleneksel RNN mimarisinden farklı olarak, hücre durumunu içeren bir bellek hücresine sahiptir. Bu hücre durumu, bilgilerin zamanla saklanmasını ve iletilmesini sağlar, böylece LSTM uzun vadeli bağımlılıkları daha etkili bir şekilde öğrenir.

LSTM'nin ana bileşenleri şunlardır:

- Unutma Kapısı (Forget Gate): Hangi bilgilerin bellekten silineceğini belirler.
- Giriş Kapısı (Input Gate): Yeni bilgilerin hangi kısmının belleğe ekleneceğini belirler.
- Çıkış Kapısı (Output Gate): Bellekten alınan bilgilerin ne kadarının kullanılacağını belirler.

Bu kapılar, LSTM'nin bilgi akışını kontrol eder ve hücre durumunu günceller. Bu sayede, LSTM uzun vadeli bağımlılıkları öğrenirken aynı zamanda kısa vadeli bilgileri de koruyabilir.

LSTM, çeşitli alanlarda başarıyla kullanılmaktadır. Özellikle doğal dil işleme, zaman serisi tahmini, konuşma tanıma ve çeviri gibi alanlarda yaygın olarak kullanılmaktadır. Bu algoritmalar, zaman içindeki karmaşık ilişkileri modellemek ve geleceği tahmin etmek için güçlü bir araç sağlar.

Sonuç olarak, LSTM algoritmaları, uzun vadeli bağımlılıkları öğrenme yeteneğiyle birlikte zaman serileri tahmini gibi birçok uygulama için güçlü bir araçtır. Sürekli gelişen yapısıyla, LSTM'nin gelecekte daha birçok alanda kullanılması beklenmektedir.

#### Aydeniz Kuraklık İndisi

Prof. Dr. Akgün AYDENİZ' in 1973 yılında geliştirmiş olduğu formüle dayanmaktadır. Aydeniz (1985), özellikle kurak dönemlerin ve indislerin belirlenmesinde, sadece yağış ve sıcaklık parametrelerinin kullanımının yetersiz olduğunu ve gerçeğe yakın değerlerin elde edilmesinde nem-yağış ilişkisi ile sıcaklık-güneşlenme süresi ilişkilerinin göz önünde bulundurulmasının daha uygun sonuçlar vereceğini bildirmiştir. Aydeniz formülünde yer alan parametreler ortalama sıcaklık, yağış, ortalama nem yüzdesi, ortalama güneşlenme yüzdesidir.

$$N_{ks} = \frac{YN*12}{S*Gs+15} \quad K_{ks} = \frac{1}{N_{ks}}$$

Y: Aylık toplam yağış (cm)

N: Aylık ortalama nem (%)

S: Aylık ortalama sıcaklık (°C)

Kks: Kuraklık katsayısı

Gs: Güneşlenme süresi (%)

Nks: Nemlilik katsayısı

Tablo 1. Aydeniz Kuraklık İndisi tablosu

Nks	İklim Özelliği	Kks
0.40 den az	Çöl	2.5 den fazla
0.40 – 0.67	Çok Kurak	1.50 - 2.50
0.67 – 1.00	Kurak	1.00 – 1.50
1.00 – 1.33	Yarı Kurak	0.75 – 1.00
1.33 – 2.00	Yarı Nemli	0.50 – 0.75
2.00 – 4.00	Nemli	0.25 – 0.50
4.00 den fazla	Çok Nemli (Islak)	0.25 den az



Diğer kuraklık indislerinde sadece yağış verileri alınırken Aydeniz Kuraklık İndisi'nde sıcaklık, yağış, nem, güneşlenme süreleri kullanılmaktadır. Aydeniz metodunu seçilmesindeki en önemli etken veriler ile kuraklık indisi arasında nonlineer bir ilişki gözlemlenmesidir.



## VERİLERİN TOPLANMASI VE AĞIN EĞİTİMİ

Bolu Meteoroloji Genel Müdürlüğü'nden 1960-2020 yılları arasındaki aylık ortalama yağış, nem, sıcaklık, güneşlenme süresi verileri alınmıştır.

Yıl	T (Ortalama Sıcaklık C)	RH (Nispi Nem %)	Güneşlenme Süresi (saat/dk)	P (Yağış cm)
1961/1	-0,90	0,867	0,75	4,21
1961/2	1,10	0,889	0,56	5,8
1961/3	4,10	0,75	1,52	5,44
1961/4	11,50	0,719	2,09	4,1
1961/5	14,40	0,732	2,11	3,93
...	...	0,8	2,16	7,9
...	...	...	...	...
...	...	...	...	...
1961/6	17,40	...	...	...
2019/7	18,80	0,7	3,295	5,1
2019/8	19,50	0,7	3,047	6,9
2019/9	16,50	0,7	2,463	0,6
2019/10	13,80	0,8	2,082	1,6
2019/11	9,20	0,7	1,635	2,5
2019/12	4,10	0,817	1,003	3,47

Şekil 1. Ham veriler

Alınan veriler Matlab programının işleyebileceği şekilde düzenlenmiştir. Verilerin seçilen aktivasyon fonksiyonunun çıkış aralığında verimli sonuçlar elde etmek için normalizasyonu yapılmıştır. Normalizasyon değişken içinde yer alan sayıları genellikle 0 ve 1 arasına hapseden bir yöntemdir. Veri setlerimizdeki değerler negatif olmadığı için normalizasyon tercih edilmiştir.

$$X' = \frac{X_i - X_{min}}{X_{max} - X_{min}} \quad (1)$$

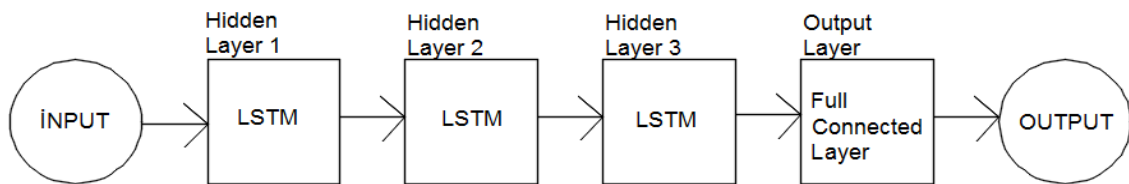
$X'$  = Normalize edilmiş veri

$X_i$  = Girdi değeri

$X_{min}$  = Girdi setinin minimum değeri

$X_{max}$  = Girdi setinin maximum değeri

Ağın eğitimi için eğitim oranı %70 olarak belirlenmiştir. Her bir veri seti için 1 girdi, 1 çıktı ve gizli katmanlar olmak üzere ağ yapısı Şekil 2'de belirtilmiştir.

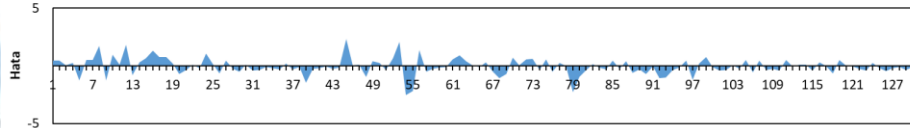
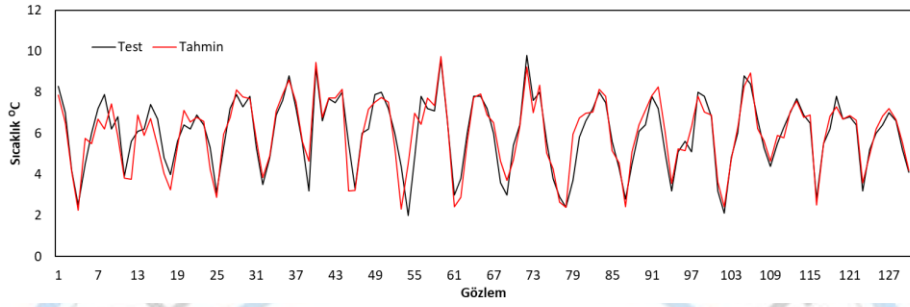


Şekil 2. Mevcut Veriler İçin Ağ Yapıları

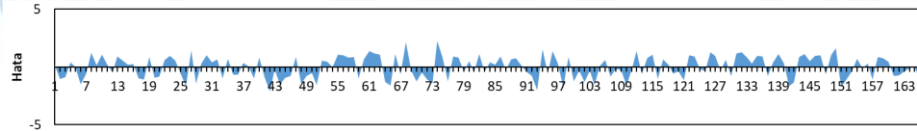
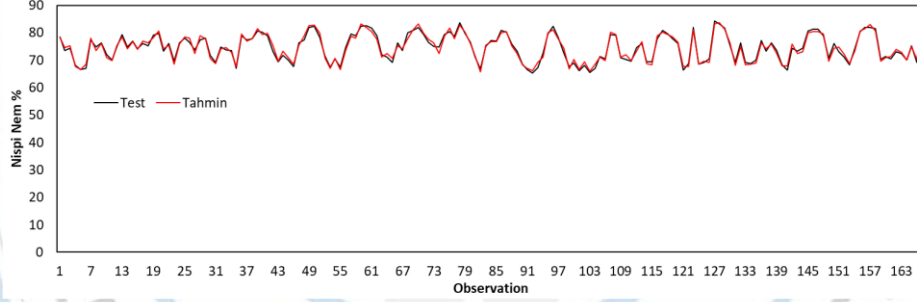
Ağ eğitim parametreleri belirlenirken hata oranlarına göre belirlenmiştir. Hata oranları MSE (Mean squared error), RMSE(Root mean squared error), MAE(Mean absolute error), MAPE(Mean absolute percentage error) olmak üzere dört gruba ayrılmıştır. Bu çalışmada RMSE (Root mean squared error) kullanılmıştır.

$$RMSE = \sqrt{\frac{1}{n} \sum_{i=1}^n X_i - M_i^2} \quad (2)$$

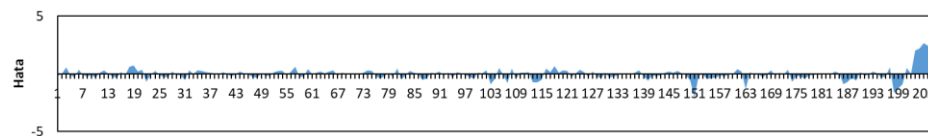
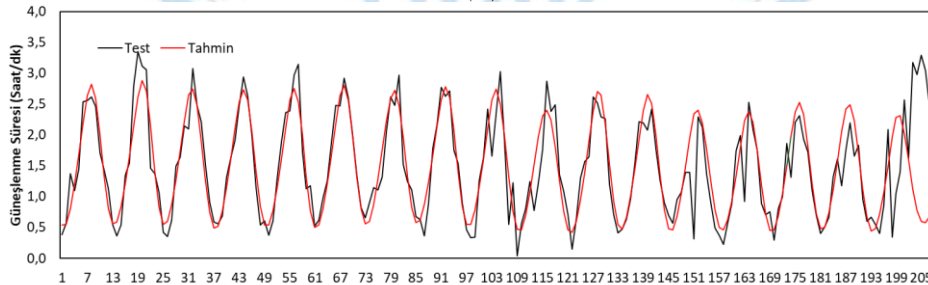
Denklem 2’de verilen formüle göre sıcaklık, nem, güneşlenme süresi, yağış verileri için hatalar hesaplanmış ve grafiği Şekil 3’de gösterilmiştir.



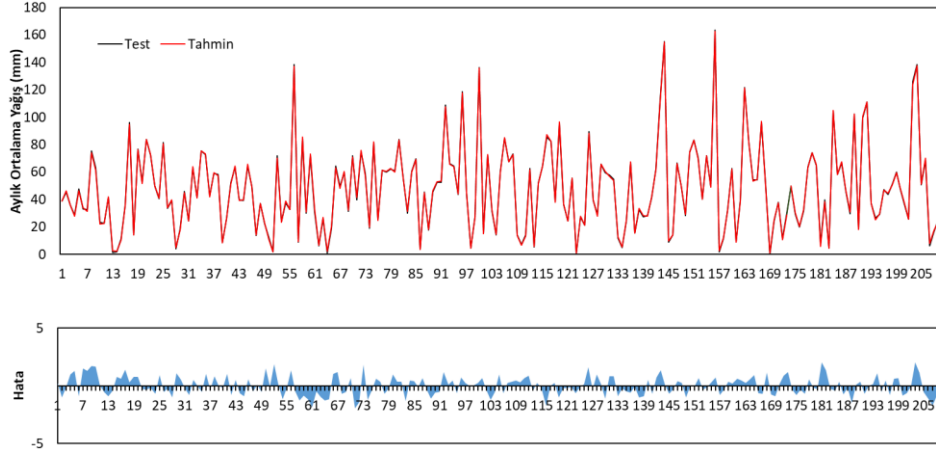
(a)



(b)



(c)



(d)

Şekil 3. Mevcut veriler için hata grafiği

a) Sıcaklık b) Nem c) Güneşlenme Süresi d) Yağış

Seçilen ağ özellikleri ile ağ yapıları oluşturulmuş ve eğitimler başlamıştır. Hata oranları en düşük olacak şekilde her bir veri seti için ağ eğitim parametreleri (nöron, katman sayısı, öğrenme oranı, öğrenme oranı periyodu, öğrenme oranı periyot faktörü, Epoch) Tablo 2’de tespit edilmiştir.

Tablo 2. Ağ Eğitim Parametreleri

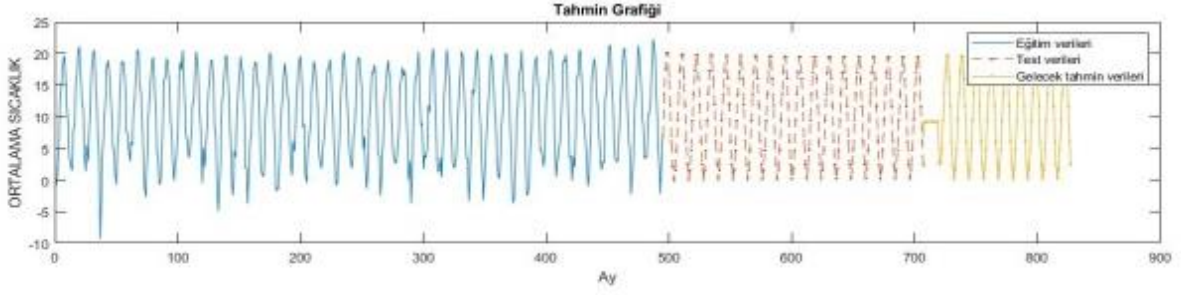
	Yağış	Nem	Sıcaklık	Güneşlenme Süresi
<b>Girdi</b>	1	1	1	1
<b>Nöron</b>	200-200-100	85-125-125- 85-50-100	100-200- 200-	100-200-100-100
<b>Katman Sayısı</b>	3	6	3	4
<b>Çıktı</b>	1	1	1	1
<b>Öğrenme oranı</b>	0,005	0,009	0,005	0,005
<b>Öğrenme oranı periyodu</b>	10	100	10	15
<b>Öğrenme oranı periyot faktörü</b>	1	0.1	0.9	0.8
<b>Epoch</b>	500	700	400	400
<b>RMSE</b>	0,807283	0,937165	0,712922	0,514932

## SONUÇLAR VE ÖNERİLER

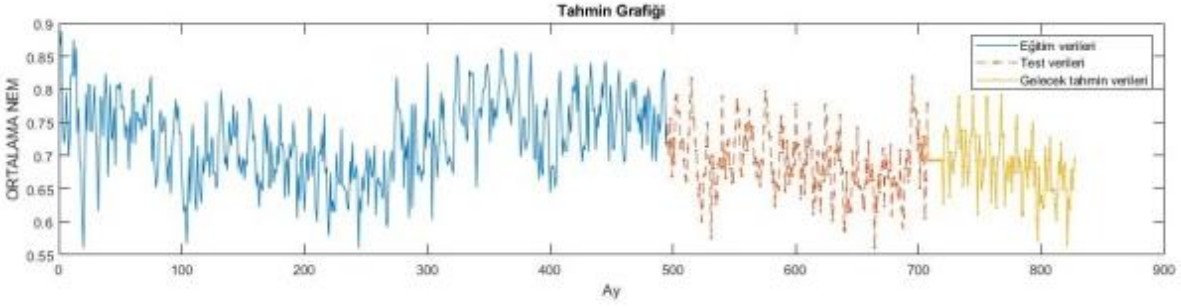
Çalışmada 1960-2020 yılları arasındaki sıcaklık, nem, güneşlenme süresi ve yağış verileri işlenmiştir. Verilerin seçilen aktivasyon fonksiyonunun çıkış aralığında verimli sonuçlar elde etmek için normalizasyonu yapılmıştır. Normalize edilen verilerin %70’i eğitim, %30’u onaylama ve test için ayrılmıştır. Ağın eğitimi için gerekli nöron, katman sayısı, öğrenme oranı, öğrenme oranı periyodu, öğrenme oranı periyot faktörü, Epoch sayısı belirlenmiştir. RMSE hata hesabı yapılarak verimli ağ elde edene kadar eğitim işlemi devam etmiştir. Eğitimi tamamlanan ağ için matlab’de LSTM kullanılarak tahmin aşamasına geçilmiştir. Test veri sayısı kadar ay tahmin sayısı olarak belirlenmiştir. Tahmin işlemi yapılırken dönemsel tahmin baz alınmıştır. Tahmin edilecek yılın ocak ayı tahmini için önceki dönemleri ocak aylarındaki verilerden yararlanılarak tahmin yapılmıştır.

Tahmini yapılan veriler hata grafikleri ile birlikte eğitim, test, tahmin olarak grafiği Şekil 4’de çizdirilmiştir.

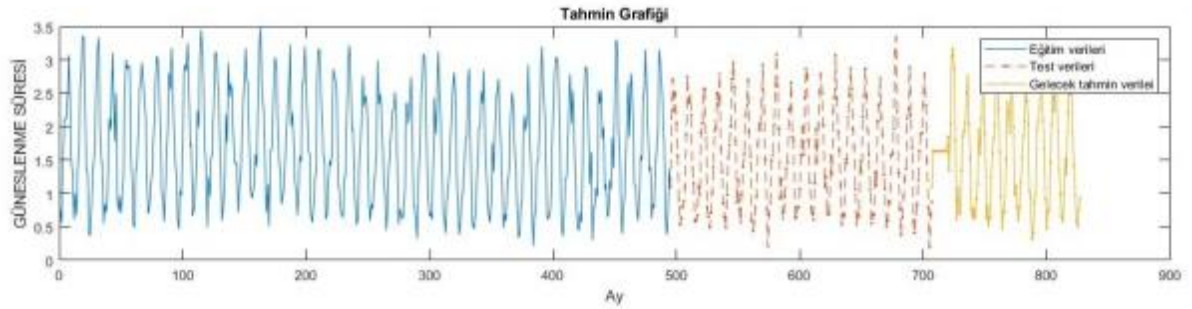




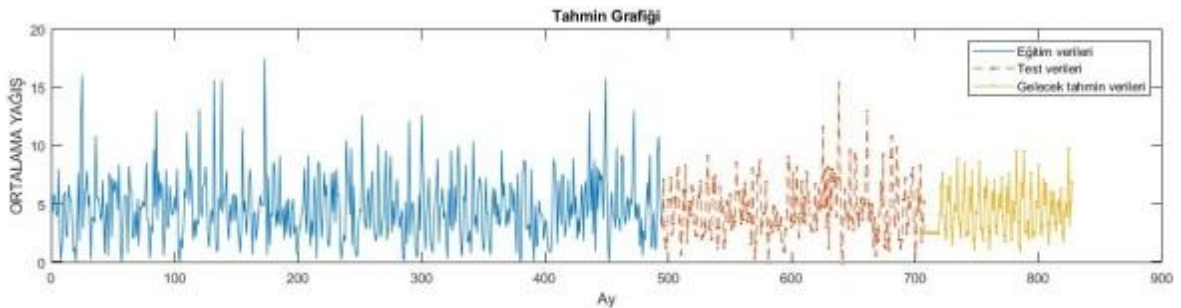
(a)



(b)



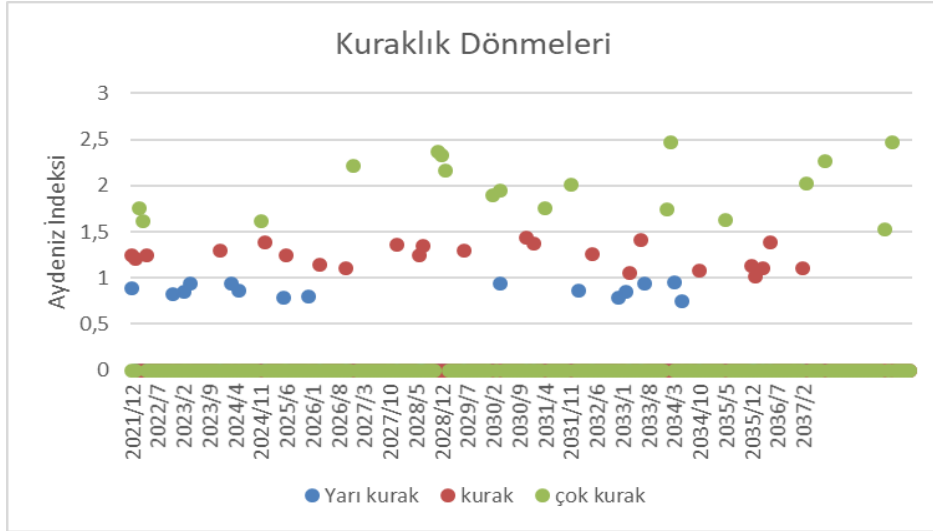
(c)



(d)

Şekil 4. Mevcut veriler için tahmin grafiği  
a) Sıcaklık b) Nem c) Yağış d) Güneşlenme Süresi

Tahmin verileri excel formatına çıkarılarak Aydeniz Kuraklık İndeksleri hesaplanmıştır. Aydeniz Kuraklık İndeksine göre sınıflandırma yapılmıştır. Şekil 5'de yapılan sınıflandırma sonrasında 2026-2030 arası dönemlerde çok kurak ve kurak dönemlerin baskın olduğu görülmektedir. Bu dönemler için hazne işletim modeli kurulması tavsiye edilmektedir.



Şekil 5. Kuraklık dönemleri

### Kaynaklar

- Süzen A.A., Kayaalp K., 'Derin Öğrenme Yöntemleri İle Sıcaklık Tahmini: Isparta İli Örneği', Internatıol Academic Resarch Congress, Ines 2018
- Kumaş K., Ayan M., Akyüz A.Ö., Güngör A., 'Antalya İli Meteorolojik Verileri Yardımıyla Hava Sıcaklığının Yapay Sinir Ağları Metodu ile Tahmini', GÜFBED/GUSTIJ (2020) 10 (1): 146-154 DOI: 10.17714/gumusfenbil.511481
- Tuhane F., Dabanlı İ., Özbeyaz A., 'Kuraklığın Yapay Sinir Ağları İle Analizi: Adıyaman Örneği, Su Vakfı İklim Değişikliği ve Çevre', 4, (1) 25-32, Mart 2019
- Özel A., Büyükyıldız M., 'Aylık Buharlaştırma Tahmininde Yapay Zeka Yöntemlerinin Kullanılabilirliği', Ömer Halisdemir Üniversitesi Mühendislik Bilimleri Dergisi, Cilt 8, Sayı 1, (2019), 244-254
- Gümüş V., Başak A., Yenigün K., 'Yapay Sinir Ağları ile Şanlıurfa İstasyonunun Kuraklığının Tahmini', Gazi Üniversitesi Fen Bilimleri Dergisi, Part C, 6(3):621-633 (2018)
- Taşar B., Üneş F., Demirci M., Kaya Y.Z., 'Yapay sinir ağları yöntemi kullanılarak buharlaştırma miktarı tahmini', DÜMF Mühendislik Dergisi 9:1 (2018) : 543 – 551
- Okkan U., Serbeş Z.A., Gedik N., 'MATLAB ile Levenberg-Marquardt algoritması tabanlı YSA uygulaması: Aylık yağış-akış modellemesi', DÜMF Mühendislik Dergisi 9:1 (2018) : 351-362
- Yıldiran A., Yerel Kandemir S., 'Yağış Miktarının Yapay Sinir Ağları ile Tahmini', BŞEÜ Fen Bilimleri Dergisi 5(2), 97-104, 2018
- Turhan E., Özmen Çağatay H., Çetin A., 'Yapay Sinir Ağı Yöntemleri ile Aşağı Seyhan Ovası Alt Havzası Yağış-Akış İlişkisinin Modellenmesi ve Yağışlı-Kurak Dönemler Açısından İrdelenmesi', Çukurova Üniversitesi Mühendislik Mimarlık Fakültesi Dergisi, 31(2), ss. 227-241, Aralık 2016
- Şenkal O., 'Yapay Sinir Ağlarını Kullanarak Türkiye İçin Kara Yüzey Sıcaklığının Modellenmesi', Fırat Üniv. Müh. Bil. Dergisi Science and Eng. J of Fırat Univ. 28 (2), 143-147, 2016

## Automatic Modulation Classification by Using Information Theory Based Features

**Akil KUTLU<sup>1\*</sup>, Derya YILMAZ<sup>2</sup>**

<sup>1</sup>Aselsan Inc., Department of Communication and Information Technologies, 06800, Ankara, Türkiye.  
ORCID ID: 0000-0002-1107-4895

<sup>2</sup>Gazi University, Faculty of Engineering, Department of Electrical and Electronics Engineering,  
06500, Ankara, Türkiye. ORCID ID: 0000-0001-5141-2572

\*Corresponding author e-mail: akilkutlueem@gmail.com

### Abstract

*Automatic Modulation Classification (AMC) is to determine the modulation mode of the signal by processing and analyzing the received signal when the prior information of the signal is insufficient. Machine Learning (ML) algorithms have been increasingly used in the field of AMC in recent years. In this study, the performances of traditional classification methods were investigated with the new features that are based on information theory in this field, by using the two types modulated signals obtained from digital and analog modulation schemes in the levels of 0 dB, 10 dB and 20 dB Signal to Noise Ratio (SNR). For this purpose, the RadiOML2018 dataset which includes 24 types of synthetically produced digital and analog modulation was used. In this dataset, there are signal samples recorded from more than 26 SNRs for each modulation type. Unlike the features used in the literature in this field, the new features based on information theory approaches such as entropies, dimensions and recurrence measures were extracted. To examine the performances of different traditional classifying algorithms for AMC classification, Decision Trees (DTs), Support Vector Machines (SVMs), K-Nearest Neighbors (KNNs), Ensemble Classifiers (ECs), Neural Networks (NNs) and Kernel methods were used with calculated features. The results showed that the highest accuracies for 0 dB and 10 dB SNR ratios were reached with the EC as 92.9% and 96%, respectively. For 20 dB SNR, the highest accuracy is found as 99.3% with DT classifier. When these results are compared with the results in other AMC studies reviewed in the literature, it was seen that the used features give useful information and effective for higher classifying accuracies.*

**Keywords:** Automatic Modulation Classification, Feature Extraction, Information Theory, Machine Learning.

### INTRODUCTION

Modulation Classification (MC) is a technique to identify the modulation type of a modulated signal corrupted by noise (Wei, Mendel, 2000). Automatic Modulation Classification (AMC) can be made by using Likelihood-Based (LB) and Feature-Based (FB) approaches. LB approach involves computing the probability function for all modulation types of the received signal and subsequently comparing all probabilities to reach a decision based on the maximum likelihood (Xu, Su, and Zhou, 2011). Although LB gives high accuracy result, it has big computational cost as processing complexity. In FB method, the signal are analyzed with different methods in various domain and some features reflecting the characteristics of the signal are obtained. Effective identification and calculation of these features is very important for classifying modulation. In the literature, numerous features are employed from frequency, statistical and time domains for classification of modulation types and the development of AMC methodologies. The features are used as an input for classifiers having various types such as Decision Trees (DTs), Support Vector Machines (SVMs), K-Nearest Neighbors (KNNs), Ensemble Classifiers (ECs), Neural Networks (NNs) and Kernel Methods (KMs). DTs are a popular method in machine learning used for classification and regression tasks, which work by splitting the data into subsets based on the value of input features (Quinlan, 1986). SVMs are supervised learning models used for classification and regression analysis, which work by finding the hyperplane that best separates the data into different classes (Cortes and Vapnik, 1995). KNN is a simple, instance-based learning



algorithm used for classification and regression tasks, which classifies data points based on the majority class among the k-nearest neighbors (Cover and Hart, 1967). EC combine multiple learning algorithms to obtain better predictive performance than could be obtained from any of the constituent algorithms alone (Dietterich, 2000). NN are computational models inspired by the human brain, consisting of interconnected nodes or 'neurons' that work together to solve complex problems by learning from data (Rumelhart, Hinton, and Williams, 1986). KMs methods are a class of algorithms for pattern analysis, which operate by mapping data into a higher-dimensional space to make it easier to classify with linear classifiers (Shawe-Taylor and Cristianini, 2004).

In this study, the modulated signals with Amplitude Shift Keying (ASK) and On-Off Keying (OOK) modulation types produced at 0 dB, 10 dB and 20 dB SNR levels used. Some features come from information theory such as Simple Entropy (SE), Shannon Entropy (ShnE), Sample Entropy (SmpE), Approximate Entropy (ApE), Higuchi Fractal Dimension (HFD), Katz Fractal Dimension (KFD), Average Mutual Information (AMI), Recurrence Rate (RR), Laminarity (L), Determinism (D), Trapping Time (TT), some statistical properties such as Standard Deviation (SD), Median (Med), and Energy (Eng) were calculated. After the extracting features, DTs, SVMs, KNNs, ECs, NNs and KMs classifiers used for classification. As a result, the modulation classification performances of these classifiers and features, at three SNR levels, were evaluated.

## MATERIAL AND METHODS

### Material

RadioML2018 dataset will be used in this study (DeepSig, 2018). This dataset was obtained from an Over-the-air deep learning-based radio signal classification study published in the IEEE Journal of Selected Topics in Signal Processing in 2017. The data consists of 2 million samples, each with a length of 1024 samples. The data set used in the study includes synthetically produced 24-lead digital and analog radio modulations. There are samples at more than 26 signal-to-noise ratio (SNR) levels for each modulation type. In this study, 4ASK and OOK, two of these modulation types, were studied. These modulation types were examined at 0dB, 10dB and 20dB SNR levels.

### Methods

Unlike the features used in the articles examined in the literature, new features have been introduced with the aim of high performance. Effective selection and calculation of these features is extremely important for the classification of modulation. Therefore, ShnE, SmpE, ApE, RR, L, D, TT, SD, Median, HFD, KFD, Eng and AMI features are derived.

#### *Shannon Entropy*

Shannon entropy measures the unpredictability or randomness of the information content in a dataset (Shannon, 1948). Mathematically, ShnE entropy is included in the equation below.

$$H(X) = \sum_{i=1}^n P(x_i) \log_2(P(x_i))$$

In the above process,  $H(X)$  represents the entropy of the event and  $P(x_i)$  represents the probability of event i.

#### *Sample Entropy*

Sample entropy is a modification of approximate entropy that provides a more reliable measure of complexity by reducing bias and accounting for data length and noise (Richman & Moorman, 2000). Mathematically, Sample entropy is included in the equation below.

$$SmpE(m, r, N) = -\ln \frac{C_m(r)}{C_{m+1}(r)}$$

In the above process,  $m$  represent the window length,  $r$  represents the similarity threshold,  $C_m(r)$  represents the number of similarities between  $m$ -long data pieces and  $N$  refers to the total number of data points.

#### *Approximate Entropy*

Approximate entropy is a statistical measure used to quantify the amount of regularity and unpredictability in time-series data, providing insights into the complexity of physiological signals (Pincus, 1991). Mathematically, ApE is included in the equation below.

$$ApE(m, r, N) = \frac{1}{N - m + 1} \sum_{i=1}^{N-m+1} \ln \frac{C_i^m(r)}{C_{i+1}^m(r)}$$

In the above process,  $m$  represent the window length,  $r$  represents the similarity threshold,  $C_m(r)$  represents the number of similarities between  $m$ -long data pieces and  $N$  refers to the total number of data points.

#### *Recurrence Rate*

Recurrence rate is a measure used in the analysis of complex systems to quantify the frequency of recurrence events in a phase space representation of a time series data (Marwan et al., 2007). Mathematically, RR is included in the equation below.

$$RR = \frac{1}{N^2} \sum_{i,j=1}^N R_{i,j}$$

#### *Laminarity*

Laminarity is a measure used in the analysis of dynamical systems to quantify the proportion of recurrent points in a phase space representation of a time series data, reflecting the presence of laminar states or periods of similarity (Webber Jr. & Zbilut, 1994). Mathematically,  $L$  is included in the equation below.

$$L = \frac{\sum_{v=v_{min}}^n vP(v)}{\sum_{v=1}^n vP(v)}$$

#### *Determinism*

Determinism, within the realm of time series analysis, refers to the extent to which future values in a sequence can be forecasted or inferred from past observations. It signifies the presence of a clear cause-and-effect relationship or predictable behavior within the dataset. Mathematically,  $D$  is included in the equation below.

$$D = \frac{\sum_{l=l_{min}}^N lP(l)}{\sum_{v=1}^N vP(v)}$$

#### *Trapping Time*

Trapping time (TT), a measurement used in time series analysis, refers to the duration of consecutive data points exceeding the threshold value. This time specifies how long after one data point passes a certain value, the next data point occurs with the same or greater threshold value. Mathematically, TT is included in the equation below.

$$TT = \frac{\sum_{v=v_{min}}^N vP(v)}{\sum_{v=v_{min}}^N P(v)}$$

### *Standard Deviation*

Standard deviation (SD) is a calculation that measures how far values in a data set are from the mean value. The higher the standard deviation of a data set, the further the data is from the mean value. A small SD indicates that the data is close to the average value. Mathematically, SD is included in the equation below.

$$SD = \sqrt{\frac{\sum_{i=1}^n (x_i - \bar{x})^2}{n - 1}}$$

### *Median*

Median (Med) is the value in the middle when the values in a data set are ordered from smallest to largest or largest to smallest. That is, when the values in the data set are ordered from smallest to largest or largest to smallest, the value in the middle is called the median.

### *Higuchi Fractal Dimension (HFD)*

Higuchi Fractal Dimension (HFD) is a measure used to determine a coarse-grained feature of a time series. It is employed to assess the complexity and irregularity of a time series (Higuchi, 1988). Mathematically, HFD is included in the equation below.

$$HFD(k) = \frac{\log \frac{N(k)}{k}}{\log(k)}$$

### *Katz Fractal Dimension (KFD)*

Katz Fractal Dimension (KFD) measures the fractal dimension of a time series and is widely used in characterizing time series data, especially in biomedicine (Katz, 1988). Mathematically, KFD is included in the equation below.

$$KFD = \frac{\log N}{\log(L/N)}$$

### *Energy*

Energy (Eng) is a measure that represents the total power or intensity of a signal. Mathematically, Eng is included in the equation below. Mathematically, Eng is included in the equation below.

$$Eng = \int_{-\infty}^{\infty} |x(t)|^2 dt$$

### *Average Mutual Information*

Average Mutual Information (AMI) is a measure used to assess the relationship between two different variables. This metric is commonly employed to analyze the extent and dependency of relationships between variables" (Smith, 2005). Mathematically, AMI Function is included in the equation below.

$$AMIF(\tau) = \frac{1}{N - \tau} \sum_{i=1}^{N-\tau} I(x_i; x_{i+\tau})$$

## **RESULTS**

The extracted features were utilized for AMC using feature extraction techniques for 4ASK and OOK modulation types. Employing various classifiers including DTs, SVMs, KNNs ECs, and NNs within MATLAB, the research yielded promising outcomes and the best accuracy results were presented in Table 1. According to the Table 1, the Bagged Trees classifier yielded the best performances for all SNR



values and the sensitivity and specificity values of these results were also given in Table 2. Results depicted in Table 1 unveil a noteworthy trend: as the SNR increased, the classifiers give good performances. These findings underscore the correlation between higher SNR levels and enhanced classification accuracies. Moreover, it was evident that the extracted features played a pivotal role in classification efficacy. Thus, the study concludes that elevated SNR levels contribute significantly to improved accuracy rates, while the extracted features emerge as robust attributes for classification endeavors.

**Table 1.** Accuracy of classifiers

Classifier Type	Accuracy (%)		
	0 dB	10 dB	20 dB
Fine Tree	89.8	94.4	99.3
Cubic SVM	50	50	97.7
Medium KNN	50	50	97.7
Bagged Trees	92.9	96.7	99.4
Medium Neural Network	50	50	97.7

**Table 2.** Sensitivity and specificity values obtained with Bagged Trees classifier for all SNR levels

SNR Values	Sensitivity	Specificity
0dB	0.90	0.89
10dB	0.94	0.94
20dB	0.99	0.81

## DISCUSSION AND CONCLUSION

This study presents the classifier performance of different modulation types at 3 different SNR values. The impact of various features on certain modulation types and SNR levels has been observed. The effect of the parameters involved in the calculation of the properties is mentioned. The results will be evaluated taking into account the performance of the features on classification. Bagged Trees is found to be as high as 92.9% at 0dB. Bagged Trees is found to be as high as 96.7% at 10dB. Bagged Trees is found to be as high as 99.4% at 20dB. When compared with the results in other AMC articles reviewed in the literature, it was seen that the extracted features had higher accuracy.

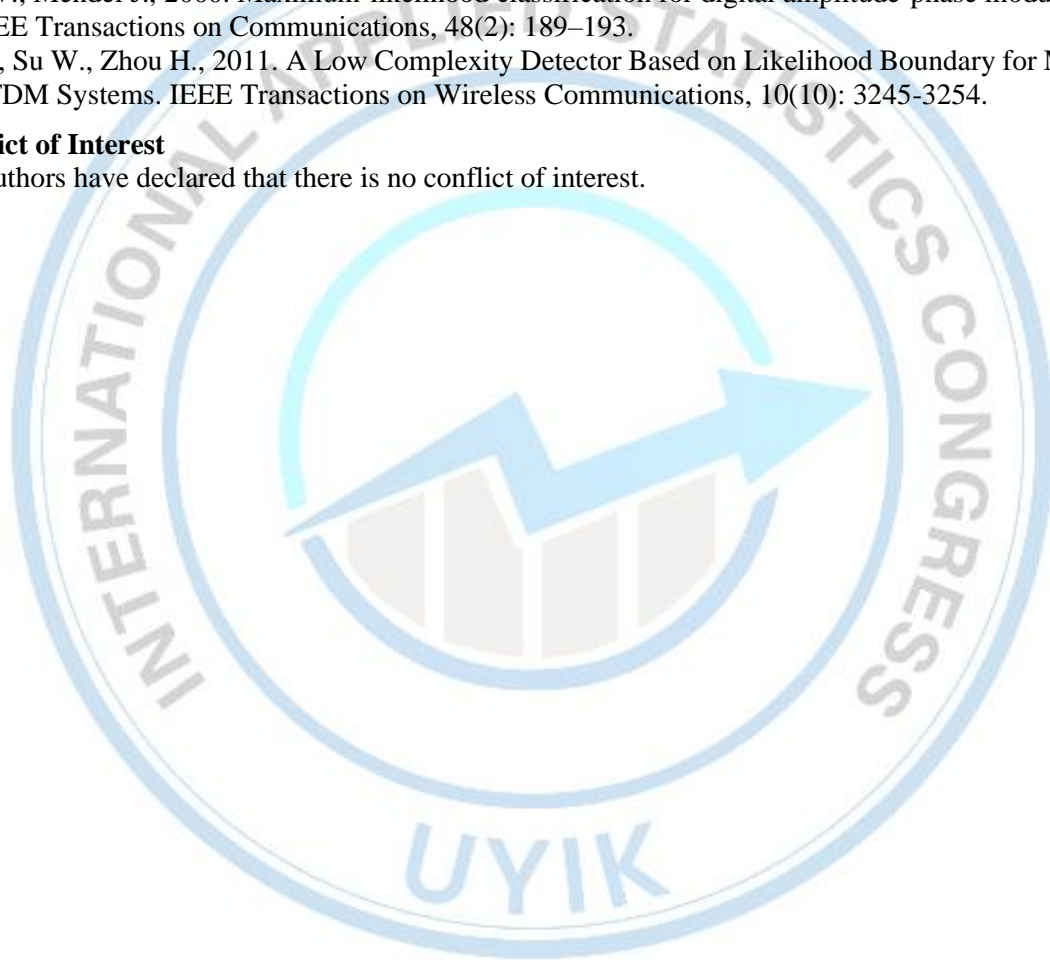
## References

- Cortes C., Vapnik V., 1995. Support-vector networks. *Machine Learning*, 20(3): 273-297.
- Cover T., Hart P., 1967. Nearest neighbor pattern classification. *IEEE Transactions on Information Theory*, 13(1): 21-27.
- DeepSig, 2018. RadiOML2018 Dataset. Access address: <https://www.deepsig.ai/datasets/>; Date of access: 12/18/2020.
- Dietterich T. G., 2000. Ensemble methods in machine learning. *Multiple Classifier Systems*, 1-15.
- Higuchi T., 1988. Approach to an Irregular Time Series on the Basis of the Fractal Theory. *Physica D: Nonlinear Phenomena*, 31(2): 277-283.
- Katz M. J., 1988. Fractals and the analysis of waveforms. *Computers in Biology and Medicine*, 18(3): 145-156.
- Marwan N., Romano M. C., Thiel M., Kurths J., 2007. Recurrence plots for the analysis of complex systems. *Physics Reports*, 438(5-6): 237-329.
- Montgomery DC, 2001. *Design and analysis of experiments*. 5th ed., John Wiley & Sons, 1-650, USA.
- Richman J. S., Moorman J. R., 2000. Physiological time-series analysis using approximate entropy and sample entropy. *American Journal of Physiology-Heart and Circulatory Physiology*, 278(6): H2039-H2049.

- Pincus S. M., 1991. Approximate entropy as a measure of system complexity. *Proceedings of the National Academy of Sciences*, 88(6): 2297-2301.
- Quinlan J. R., 1986. Induction of Decision Trees. *Machine Learning*, 1(1): 81-106.
- Rumelhart D. E., Hinton G. E., Williams R. J., 1986. Learning representations by back-propagating errors. *Nature*, 323(6088): 533-536.
- Shannon C. E., 1948. A Mathematical Theory of Communication. *Bell System Technical Journal*, 27(3): 379-423.
- Shawe-Taylor J., Cristianini N., 2004. Kernel Methods for Pattern Analysis. Editor: John Shawe-Taylor, Nello Cristianini (Editors): *Kernel Methods for Pattern Analysis*. Cambridge University Press, 1st ed., pp. 1-123, Cambridge, UK.
- Smith J., 2005. Measuring Relationships Between Variables: Average Mutual Information (AMI). *Journal of Statistics and Data Science*, 3(2): 78-92.
- Webber Jr. C. L., Zbilut J. P., 1994. Dynamical assessment of physiological systems and states using recurrence plot strategies. *Journal of Applied Physiology*, 76(2): 965-973.
- Wei W., Mendel J., 2000. Maximum-likelihood classification for digital amplitude-phase modulations. *IEEE Transactions on Communications*, 48(2): 189-193.
- Xu Y., Su W., Zhou H., 2011. A Low Complexity Detector Based on Likelihood Boundary for MIMO-OFDM Systems. *IEEE Transactions on Wireless Communications*, 10(10): 3245-3254.

**Conflict of Interest**

The authors have declared that there is no conflict of interest.



## Customer Product Propensity Modeling in the Insurance Industry

**İbrahim Furkan AKYÜZ<sup>1\*</sup>, Birsen EYĞİ ERDOĞAN<sup>2</sup>**

<sup>1</sup>Marmara University, Institute of Science, Statistics Program, 34722, Istanbul, Türkiye

\*Corresponding author e-mail: [ibrahimfurkanakyuz@gmail.com](mailto:ibrahimfurkanakyuz@gmail.com)

### **Abstract**

*With changing consumption habits in today's world, understanding customer movements and directing marketing activities has become very important. Businesses can contribute to business efficiency by making accurate analyzes of customer data available in their resources. One of these efficiency methods is analysis and modeling to find products that customers are inclined to, in order to contribute to the sales activities of businesses. Based on this idea, the factors affecting customers' tendency to purchase an insurance product were investigated with real data collected from the insurance industry. The collected data was analyzed and examined using statistical methods, and before the modeling phase, it was made most suitable for modeling by undergoing applications such as data pre-processing, feature engineering, feature selection, and data scaling. Classification models were tested with the help of machine learning algorithms with the prepared data, and a classification model was decided by selecting the most successful algorithm and parameter. This classification model took the approach of a model that predicts whether customer data will purchase an insurance product.*

**Keywords:** Modeling, Propensity, Classification

### **INTRODUCTION**

An approach to extract insight from data is; demographic information of customers (age, gender, family size, income level, education level, etc.), psychographic information of customers (personality characteristics, lifestyle, social status, etc.), customer interactions (emails opened, e-mails clicked, searches in the mobile application, duration of stay on the web page, etc.), customer experience (average service time, standby time in customer services, number of refunds, etc.) and customer behavior (number of purchasing at different times, time since the last purchasing, time since last offer, etc.) to predict the likelihood that a particular customer profile will engage in a particular type of behavior. Propensity modeling is a set of approaches to building predictive models to predict the behavior of a target audience by analyzing their past behavior.

Propensity modeling can be addressed on a variety of topics, depending on the problems that need to be solved. These topics may be propensity to buy models aimed at gaining customers or propensity to churn models aimed at keeping customers. Propensity to buy models show which customers are more or less likely to buy products or services. Propensity to churn models show which customers are dissatisfied with products or services, are at risk, are more or less likely to quit the product or services.

In this study, a modeling was designed based on real data received from the insurance industry, and it was investigated which variables affect the customer's propensity towards an insurance product and also to estimate the successful model that can distinguish between customers who buy and do not buy. The aim is to create a successful classification model setup, to find out which variables are important for a product in the insurance industry, to achieve efficiency by using the model setup created in target customer selection for businesses.

### **MATERIAL AND METHODS**

#### **Material**

Machine learning techniques can be applied to create a propensity model based on the structure and distribution of the data and the format of the output. Machine learning techniques are divided into three principal groups. These are supervised machine learning, unsupervised machine learning and



reinforcement machine learning. Supervised learning is based on the logic of loading the training dataset and test dataset into the system, making the necessary labels for each data in the dataset and thus establishing a relationship between the input dataset and the output dataset. In supervised learning, the target variable is obvious. If the target variable is numeric, the regression model is used; if it is categorical, the classification model is used. Unsupervised learning is a machine learning technique that tries to find patterns in data without any labels. Unlike supervised learning, there is no target variable in unsupervised learning. The two main methods used in unsupervised learning are clustering and dimensionality reduction. Reinforcement learning is a machine learning technique that aims to train the machine with the reactions it receives from the environment without training data. The idea involved in reinforcement learning is that the machine continuously trains itself depending on the environment and applies its enriched knowledge to solve problems.

The classification model approach is suitable for the subject of this study, which choice a customer can make on an insurance product, whether to buy or not. There are classification model solutions that are frequently used in machine learning algorithms and provide good results. These are Logistic Regression, Support Vector Machine, Random Forest and XGBoost algorithms.

Logistic Regression is a type of regression applied when the target variable is a binary variable and belongs to a class of models called generalized linear models (Hosmer, 1989). Support Vector Machine is a vector space-based machine learning method with a decision boundary between the two classes that are furthest from any point in the training data (Schlkopf, 2018). Random Forest is a batch learning method for classification, regression and other tasks that works by building large numbers of decision trees at training time (Breiman, 2001). XGBoost, eXtreme Gradient Boosting is an open source software library that provides a streamlined gradient boosting framework for C++, Java, Python, R, Julia, Perl and Scala.

The model experiments and the decided model in this study were written in Python language, in the Jupyter Notebook program. Jupyter Notebook is an open source program that provides an interactive environment for various programming languages.

## Methods

### *Dataset Description*

In this study, the dataset used for the statistical and machine learning model to be established during the application phase is real customer data, obtained anonymously from the insurance industry. The variables included in the dataset are shown in the table below.

**Table 1.** List of Variables

Variable Name	Explanation	Data Type
URUN_ADET_TOPLAM	Total number of products	Numeric
URUN_ADET_FK	Number of personal accident products	Numeric
URUN_ADET_HAYAT	Number of life products	Numeric
URUN_ADET_EMEKLILIK	Number of pension products	Numeric
MUSTERILILIK_SURE	Time without first customer	Numeric
INAKTIF_SURE	Inactive time	Numeric
KISA_KONUSMA	Number of short-term conversations	Numeric
ORTA_KONUSMA	Number of medium-term conversations	Numeric
UZUN_KONUSMA	Number of long-term conversations	Numeric

**Table 1.** List of Variables continued

Variable Name	Explanation	Data Type
MAX_SURE	Maximum time spoken	Numeric
MIN_SURE	Minimum time spoken	Numeric
SON1YIL_ARANMA	Number of searches in the last year	Numeric
SON1YIL_ULASIM	Number of transportation in the last	Numeric
SON1YIL_SATIS	Number of sales in the last year	Numeric
YAS	Customer's age	Numeric
CINSIYET	Customer's gender	Categorical
MEDENI_DURUM	Customer's marital status	Categorical
GELIR_DUZEY	Customer's income level	Categorical
EGITIM_DUZEY	Education level of the customer	Categorical
SEHIR_DUZEY	Customer's city level	Categorical
TOPLAM_AKTIF_PRIM	Customer's active total premium	Numeric
TOPLAM_PRIM	Customer's total premium	Numeric
TAZMINAT_FLAG	Receiving compensation payment	Numeric
TARGET	Purchasing/Not purchasing a product	Categorical

#### Dataset Analysis

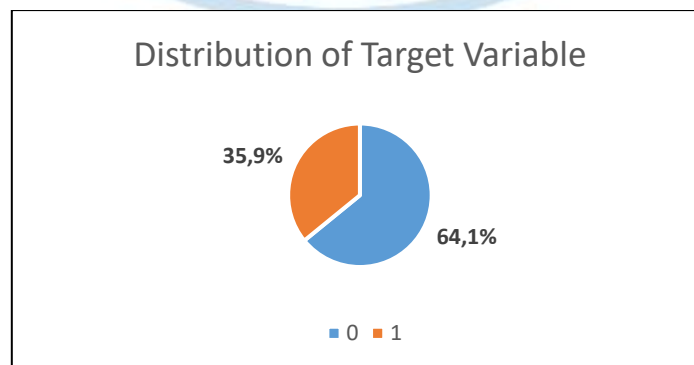
The distribution of the target variable in the dataset is summarized as follows. A value of 0 indicates that the customer has not purchased the product and a value of 1 indicates that the customer has purchased the product.

There are a total of 850 rows -customers- of data in the dataset. 305 of these data resulted in purchases.

**Table 2.** Distribution of Target Variable

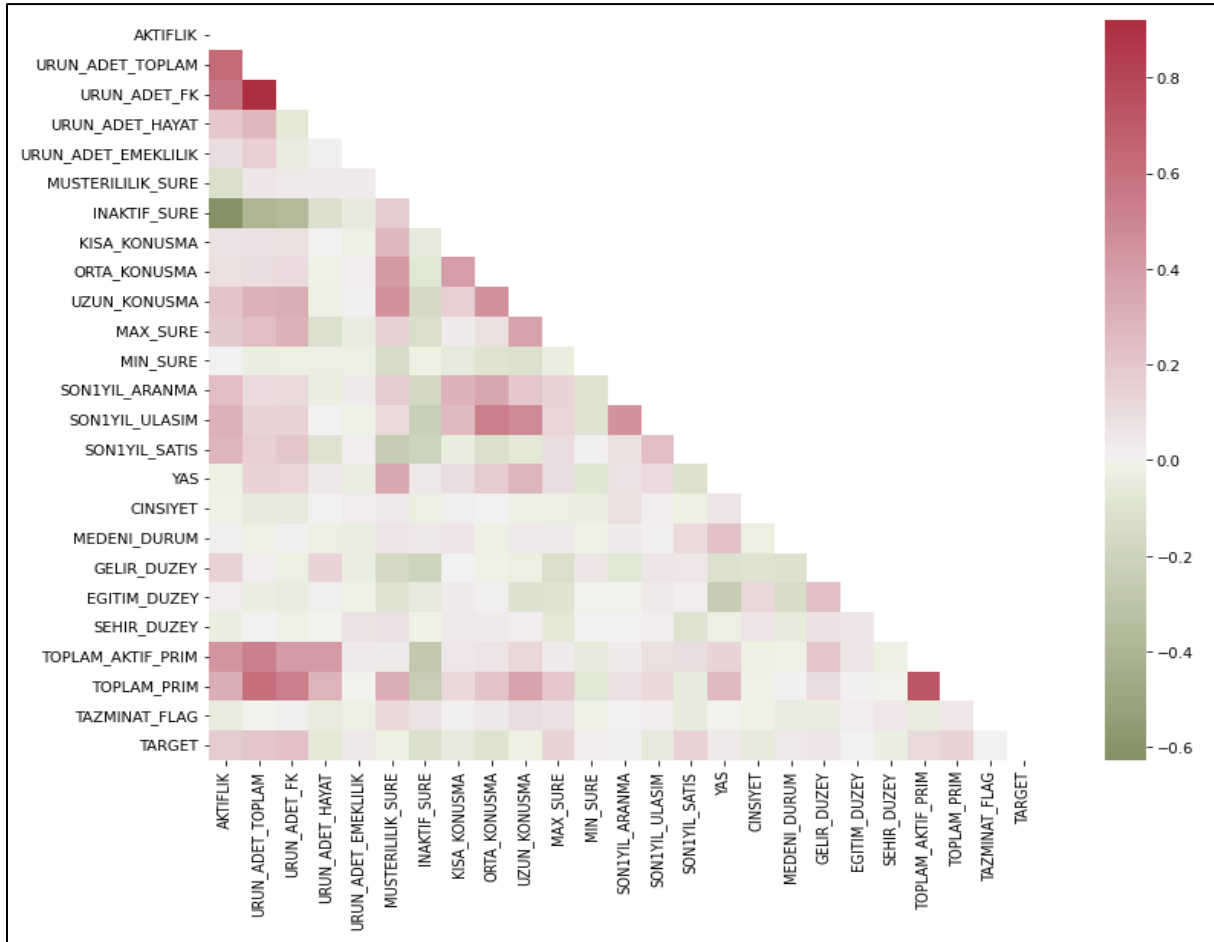
Target	Count
0	545
1	350
Total	850

35.9% of the customers in the dataset purchased the product; it appears that 64.1% have not purchased the product.



**Figure 1.** Distribution of Target Value

The correlation matrix, where the relationship between variables can be observed, is shown in Figure 2. Accordingly, the strongest relationship is the positive relationship between `urun_adet_toplam` and `urun_adet_fk` with 0.92. Strong relationships are not evident in most of the variables.



**Figure 2.** Correlation Matrix Between Variables

### Data Preprocessing

Data preprocessing is a step involved in the data mining and data modeling process that converts raw data into a format that can be understood and analyzed by computers. Data preprocessing can refer to manipulating or reducing data before use to ensure or improve performance. Missing or defective values may be encountered during data collection or creation methods. Analyzing data that has not been carefully screened for such problems may yield misleading results. Therefore, the representation and quality of the data come first before performing any analysis (Pyle, 1999). The methods used in the literature as data preprocessing steps can be listed as data cleaning, data reduction, data transformation.

When the dataset used in this study is examined, the first striking detail is the presence of variables with categorical data type. These are `cinsiyet`, `medeni_durum`, `gelir_duzey`, `egitim_duzey`, `sehir_duzey`. In order for these variables to be read by machine learning algorithms, these variables must be converted to numeric values. Label Encoding is a method used to convert categorical columns into numeric columns to fit machine learning models that only receive numeric data. Five variables related to this method are converted into numeric columns.

After converting these variables into numeric columns, the data distribution is shown in Figure 3.



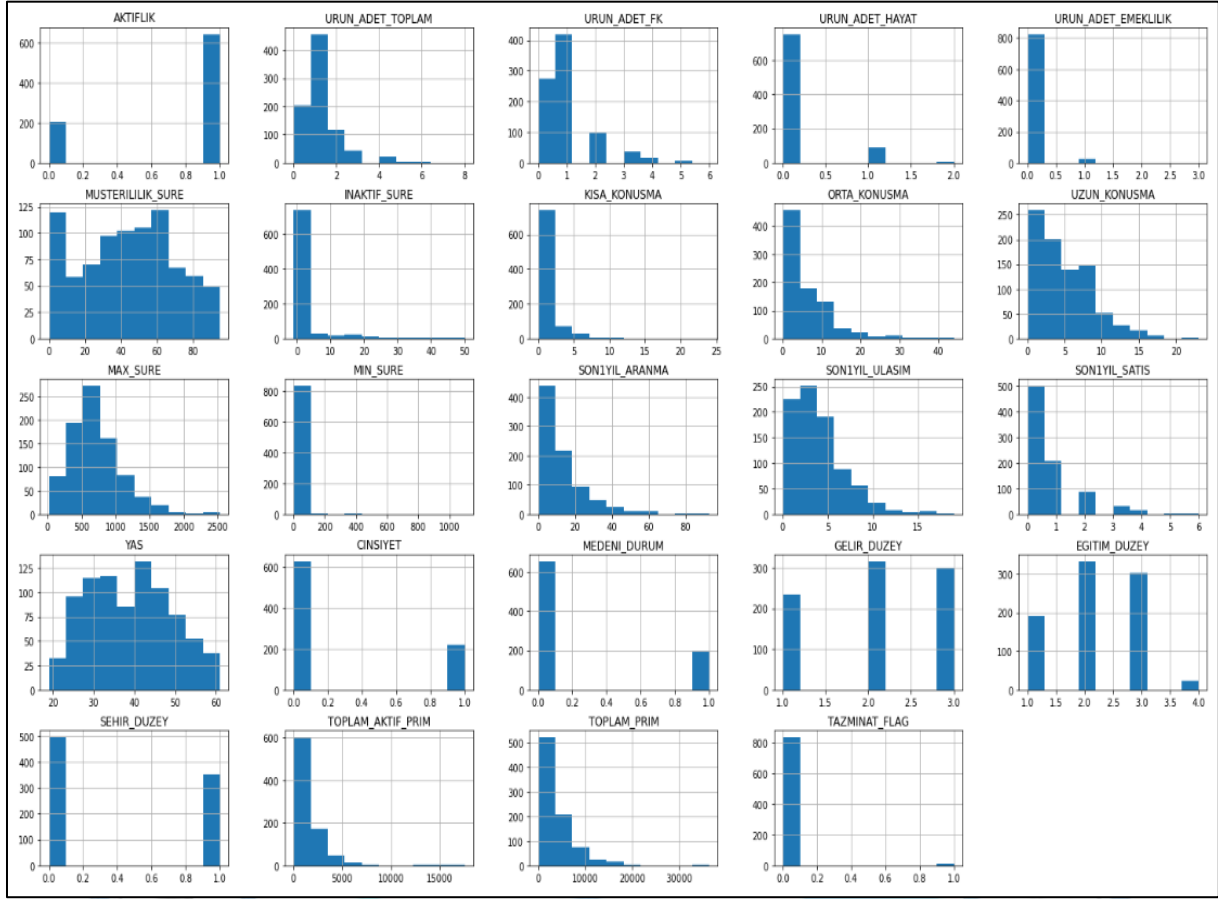


Figure 3. Distribution of Data

By looking at the summary histogram distribution graphs of all variables given in Figure 3, it is seen that some variables have outlier values when the data distribution is examined. These variables are `urun_adet_toplam`, `urun_adet_fk`, `urun_adet_hayat`, `urun_adet_emeklilik`, `inaktif_sure`, `kisa_konusma`, `orta_konusma`, `uzun_konusma`, `max_sure`, `min_sure`, `sonlyil_aranma`, `sonlyil_ulasim`, `sonlyil_satis`, `toplam_aktif_prim`, `toplam_prim`. Before making a decision about these variables, they should be examined in detail.

Detailed analysis for relevant variables that need to be re-examined is shown in Figure 4.

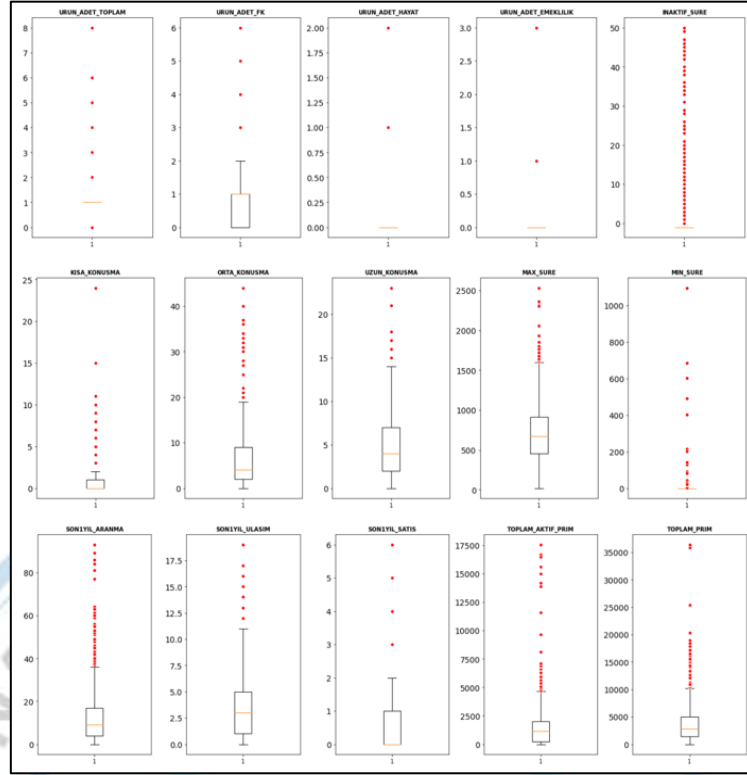


Figure 4. Variables with Outliers

The data was updated by replacing the outliers with the 99th percentile value of the relevant variable. The resulting data distribution is shown in Figure 5.

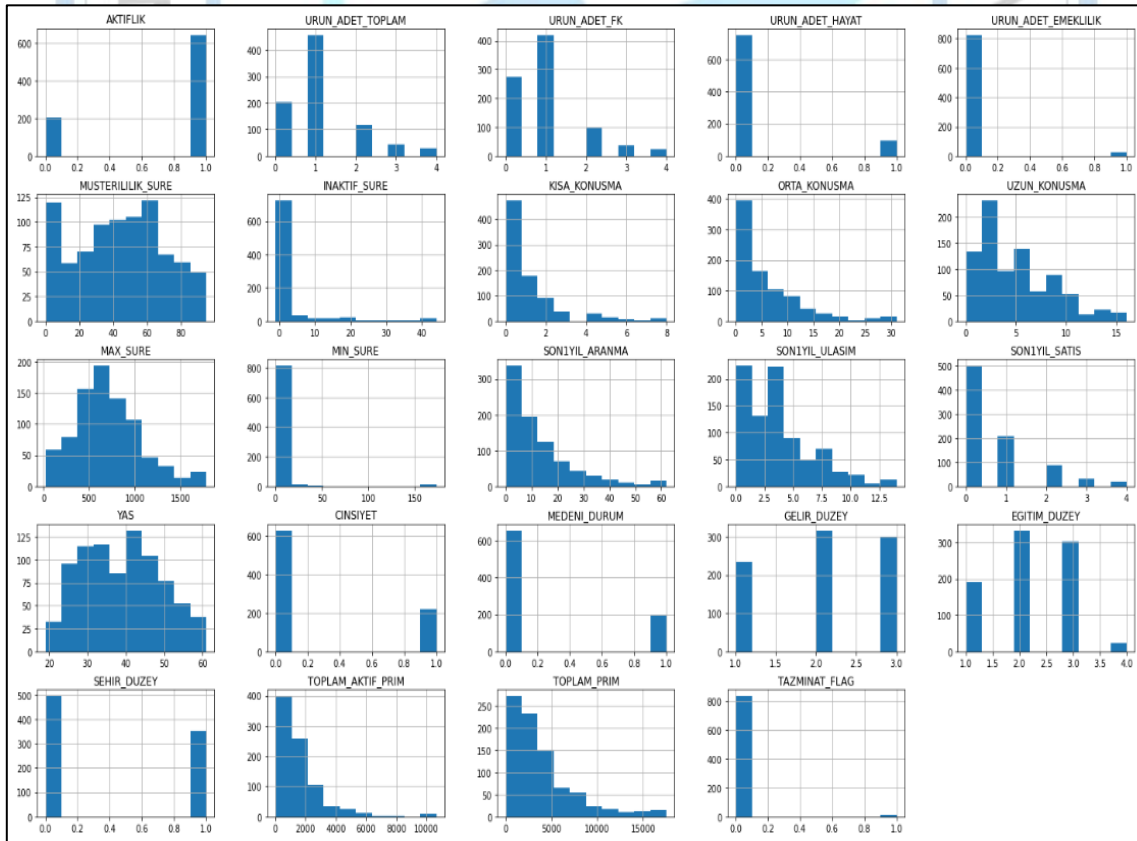


Figure 5. Distribution of Data After Data Preprocessing

The changes made to the data after the data preprocessing process are summarized as follows.

- Converting categorical columns to numeric columns
- Detection and suppression of outliers

#### *Feature Engineering*

Feature engineering or feature extraction or feature discovery is the process of using domain knowledge to extract features (characters, attributes) from raw data. The main motivation in feature engineering is to use extra features to improve the quality of the results obtained from a machine learning process, compared to using only raw data in a machine learning process.

Feature engineering aims to increase the predictive power of machine learning algorithms and achieve better results by creating new features that help streamline the machine learning process.

The following applications were made on the existing variables in this study.

- The `sonlyil_ulasim_oran` variable was created based on the ratio of last year transportation and last year search variables.
- The `sonlyil_satis_oran` variable was created based on the ratio of last year sales and last year transportation variables.
- The variable `kisa_konusma_oran` was created based on the ratio of the number of short speeches to the number of short, medium and long speeches. By calculating this ratio for all variables in this group, the variables `orta_konusma_oran` and `uzun_konusma_oran` were created.
- The `toplam_aktif_prim_oran` variable was created based on the ratio of total active premium and total premium variables.
- The average of the total active premium value in the entire dataset was determined and the `toplam_aktif_prim_grup` variable was created by assigning values of 1 and 0 for the data higher and lower than this average.
- The `toplam_prim_grup` variable was created by determining the average of the total premium value in the entire dataset and assigning values of 1 and 0 for the data higher and lower than this average.
- The variables `urun_adet_fk_flag`, `urun_adet_hayat_flag` and `urun_adet_emeklilik_flag` were created using the values 1 and 0 to define the expression yes and no, over the variables showing the product quantities.
- Customer service duration and inactive period variables were converted from monthly values to annual values and customer `musterililik_sure_grup` and `inaktif_sure_grup` variables were created.
- A new variable was created by age grouping based on the age variable. By following an intuitive method to meet business needs, age groups of 18-25, 26-35, 36-45, 46-55, 56-65 and 65+ were created. These groups are defined as `yas_grup_1`, `yas_grup_2`, `yas_grup_3`, `yas_grup_4`, `yas_grup_5`, `yas_grup_6`, respectively.
- Among the raw variables, `gelir_duzey` and `egitim_duzey` variables were converted into dummy variables. Among these variables, `gelir_duzey_1` is defined as low, `gelir_duzey_2` is medium, `gelir_duzey_3` is high, `egitim_duzey_1` is defined as primary education, `egitim_duzey_2` is high school, `egitim_duzey_3` is defined as university, `egitim_duzey_4` is defined as master's degree and above.
- Among the newly created variables, `musterililik_sure_grup`, `inaktif_sure_grup`, `yas_grup` variables have been converted into dummy variables.

After that iteration, the total number of columns in the dataset increased from 25 to 60 and the total number of variables increased from 23 to 58.

#### *Feature Selection*

Feature selection is the process of reducing the number of input variables when developing a predictive model. In machine learning models such as regression or classification, there are often too many variables or features to work with. As the number of features increases, the difficulty of modeling them may increase. Irrelevant or partially relevant features can negatively impact model performance. It is desirable to reduce the number of input variables, both to improve the performance of the model and, in some cases, to reduce the computational cost (Murphy, 2012).

In this study, Lasso Regression method was used in the feature selection process. The main purpose



of Lasso Regression is feature selection and organization of data models. With the increasing number of variables in the feature engineering step, the variables that were meaningful among all variables were wanted to be used as model input.

Apart from the id and target columns, there are 58 columns on the dataset, that is, variables that can be entered as input into the model. The number of variables was reduced to 22 after the Lasso Regression method was applied, with the optimum number of variables at the  $\alpha = 0.005$  significance level. The coefficients were close to zero and the number of variables minimized to zero was 36.

#### Data Scaling

Variables measured at different scales do not contribute equally to the model fitting and model learning function and may create a bias in the result. Therefore, to deal with this potential problem, the scaling method is applied on the variables.

Standardization or Standard Scaler is a method performed before many machine learning models are built to standardize the range of functionality of the input dataset. This method is used to resize the distribution of values so that the observed values have a mean of 0 and a standard deviation of 1.

Before establishing the machine learning model, all variables remaining after the Lasso Regression process in the dataset were standardized.

#### Model Performances

Machine learning models were established with Logistic Regression, Support Vector Machine, Random Forest and XGBoost algorithms for creating propensity to buy model. The models were built on the same training and test set. The training set ratio is 80% of dataset and the test set ratio is 20% of dataset.

Classification reports of the created models are shown in Figure 6. Classification reports include accuracy, precision, recall and F1 score performance metrics of the models.

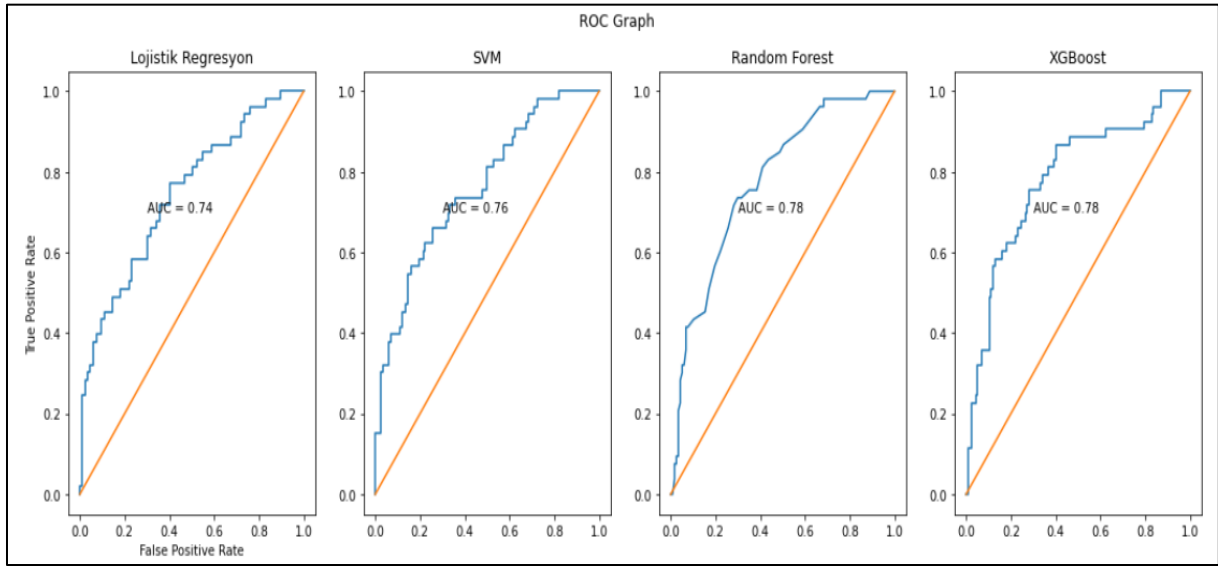
Lojistik Regresyon: Model Accuracy: 73.0					SVM: Model Accuracy: 75.0				
	precision	recall	f1-score	support		precision	recall	f1-score	support
0	0.78	0.85	0.81	117	0	0.76	0.94	0.84	117
1	0.59	0.45	0.51	53	1	0.72	0.34	0.46	53
accuracy			0.73	170	accuracy			0.75	170
macro avg	0.68	0.65	0.66	170	macro avg	0.74	0.64	0.65	170
weighted avg	0.72	0.73	0.72	170	weighted avg	0.75	0.75	0.72	170
Random Forest: Model Accuracy: 77.0					XGBoost: Model Accuracy: 77.0				
	precision	recall	f1-score	support		precision	recall	f1-score	support
0	0.78	0.93	0.85	117	0	0.82	0.85	0.84	117
1	0.73	0.42	0.53	53	1	0.65	0.58	0.61	53
accuracy			0.77	170	accuracy			0.77	170
macro avg	0.76	0.67	0.69	170	macro avg	0.73	0.72	0.73	170
weighted avg	0.76	0.77	0.75	170	weighted avg	0.77	0.77	0.77	170

**Figure 6.** Performance Metrics of the Models

According to the results of the classification reports:

- Accuracy rates were over 70 points in each model and the best algorithms were Random Forest and XGBoost algorithms.
- The XGBoost algorithm achieved the best F1 score in 1 prediction. In the prediction of 0, the F1 score is the second model.

AUC-ROC curve comparison of the models is shown in Figure 7.



**Figure 7.** AUC-ROC Curve of the Models

According to the AUC-ROC curve results:

- The AUC score of the Logistic Regression model was 0.74; the AUC score of the Support Vector Machine model was 0.76; the AUC score of the Random Forest algorithm was 0.78; the AUC score of the XGBoost algorithm was 0.78.

## RESULTS

A comparison of the results obtained with the original variables and the results obtained after the feature engineering and feature selection stages is shown in Table 3.

**Table 3.** Model Comparison

Model Name	Accuracy	AUC-ROC	F1 Score
Logistic Regression with Original Variables	0.69	0.71	0.39
Support Vector Machine with Original Variables	0.68	0.72	0.18
Random Forest with Original Variables	0.76	0.76	0.54
XGBoost with Original Variables	0.72	0.74	0.49
Logistic Regression with New Features	0.73	0.74	0.51
Support Vector Machine with New Features	0.75	0.76	0.46
Random Forest with New Features	0.77	0.78	0.53
XGBoost with New Features	0.77	0.78	0.61

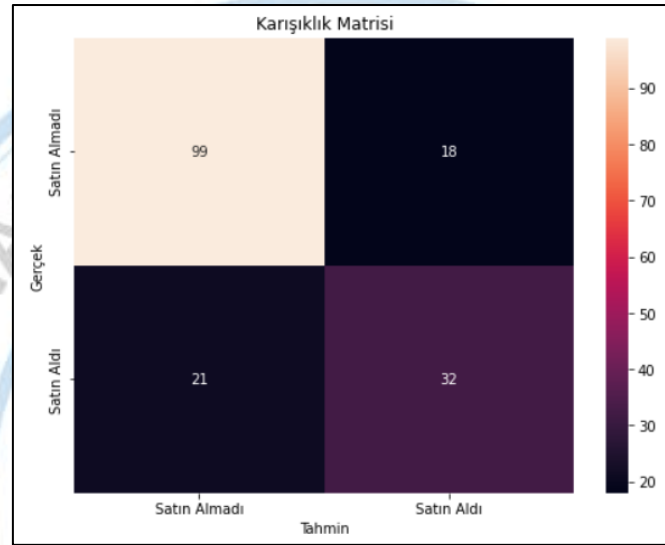
When the classification reports and AUC-ROC curves were examined, the most successful model was chosen as the model belonging to the XGBoost with New Features algorithm.

The classification report of the improved model was run again. The difference between this model and the previous model is the addition of selected hyperparameters to the model function. The classification report of the improved model is shown in Figure 8.

XGBoost Tuned:				
Model Accuracy: 77.06				
	precision	recall	f1-score	support
0	0.82	0.85	0.84	117
1	0.64	0.60	0.62	53
accuracy			0.77	170
macro avg	0.73	0.72	0.73	170
weighted avg	0.77	0.77	0.77	170

**Figure 8.** XGBoost Tuned Model Classification Report

The confusion matrix output of the final model obtained, the XGBoost Tuned model, is shown in Figure 9.



**Figure 9.** XGBoost Tuned Model Confusion Matrix

In machine learning, feature importance scores are used to determine the relative importance of each feature in a dataset when building a predictive model. Calculating feature importance is a method for ranking features according to their contribution to the prediction. Feature importance refers to techniques that calculate a score for all input features for a given model.

The importance level of the variables selected for the XGBoost Tuned model, which is the final model obtained, is shown in Table 4.

**Table 4.** Feature Importance Scores

Variable Name	Importance Score
URUN_ADET_FK	0.104066
SONIYIL_ULASIM_ORAN	0.056268
SONIYIL_SATIS	0.056192
MAX_SURE	0.054433
YAS	0.051663
MEDENI_DURUM	0.049584
YAS_GRUP_3	0.048799



**Table 4.** Feature Importance Scores continued

Variable Name	Importance Score
ORTA_KONUSMA	0.047688
UZUN_KONUSMA	0.047350
TOPLAM_PRIM_GRUP	0.045580
MUSTERILILIK_SURE	0.043117
SONIYIL_ARANMA	0.041984
EGITIM_DUZEY_1	0.041684
KISA_KONUSMA	0.040309
TOPLAM_AKTIF_PRIM_GRUP	0.039079
INAKTIF_SURE	0.038413
GELIR_DUZEY_3	0.037984
SONIYIL_ULASIM	0.037656
CINSIYET	0.032812
URUN_ADET_HAYAT	0.030648
EGITIM_DUZEY_2	0.028587
MIN_SURE	0.026104

## DISCUSSION AND CONCLUSION

Using resources efficiently is always important for businesses. A method that can provide this efficiency is for businesses to find the propensity of their customer base with the help of statistical models and to implement marketing activities by targeting the right customer base in line with the results they find. Based on this idea, in this study, the factors affecting customers' tendency to purchase an insurance product were investigated with real data collected from the insurance industry. The collected data consists of 1 column expressing customer identity, 1 dependent variable and 24 independent variables. The data was examined, introduced and analyzed in detail. Data preparation stages were carried out before establishing a model with the help of machine learning algorithms. In these stages, data preprocessing was performed, new variables were created from the variables in the data, variable selection was made using statistical methods and data scaling was performed. In the final stage, classification models were established with machine learning algorithms. The XGBoost algorithm was selected as the champion model algorithm.

## References

- Breiman, L., (2001). "Random Forests" Machine Learning, 45: 5–32.
- Hosmer, D.W., Lemeshow, S., (1989). Applied Logistic Regression, The Multiple Logistic Regression Model, 25-37.
- Murphy, K.P., (2012). Machine learning: a probabilistic perspective, MIT Press, 86.
- Pyle, D., (1999). Data Preparation for Data Mining. Morgan Kaufmann Publishers, Los Altos, California.
- Schlkopf, B., (2018). Learning with Kernels: Support Vector Machines, Regularization, Optimization and Beyond, MIT Press, ISBN 0-262-53657-9. OCLC 1039411838.

## Acknowledgment

I would like to my endless gratitude to Prof. Dr. Birsen EYĞİ ERDOĞAN, who showed interest and support in the planning, research and execution of the study and to my family and loved ones who have always supported me throughout my life.

## Conflict of Interest

The authors have declared that there is no conflict of interest.

**Weighted Approximation of the Stancu Type Generalisation of the Chlodowsky-Szasz Mirakyan Hybrid Operator**

**Afşin Kürşat Gazanfer<sup>1\*</sup>, Şeyda Ünal<sup>1</sup>**

<sup>1</sup>Zonguldak Bülent Ecevit University, Faculty of Science, Department of Mathematics, 67100, Zonguldak, Türkiye

\*Corresponding author e-mail: afsinkursat@beun.edu.tr

**Abstract**

The following text describes the use of positive linear operators that are incorporated with the Stancu type generalization of Chlodowsky and Szasz type operators. The study focuses on the approximation properties of these operators in the space of continuous functions of two variables on a compact set. The convergence rate of these operators is determined through the modulus of continuity, and weighted approximation properties are also explored for these positive linear operators in a weighted space of functions of two variables. The convergence rate for these operators is established using the weighted modulus of continuity.

**Keywords:** Modulus of continuity, weighted approximation, rate of convergence.

**INTRODUCTION**

Let  $x \in \mathbb{R}^{+,0} = [0, \infty)$  and  $f \in C(\mathbb{R}^{+,0})$ . The Chlodowsky polynomial, commonly referenced in mathematics and denoted by  $B_n^*(f; x)$ , is a well-known concept in which the degree is denoted as  $n$

$$B_n^*(f; x) = \sum_{k=0}^n \binom{n}{k} \left(\frac{x}{b_n}\right)^k \left(1 - \frac{x}{b_n}\right)^{n-k} f\left(\frac{k}{n}b_n\right), \quad 0 \leq x \leq b_n \quad (1)$$

where  $(b_n)$  is characterized by a sequence of positive numbers with specific properties

$$\lim_{n \rightarrow \infty} b_n = \infty, \quad \lim_{n \rightarrow \infty} \frac{b_n}{n} = 0. \quad (2)$$

Stancu provided a generalisation of Bernstein operators for  $x \in [0,1]$  with two parameters  $r, s \in \mathbb{N} \cup \{0\}$ :

$$C_{k,s}(f; x) = \sum_{k=0}^{n-sr} \binom{n-sr}{k} x^k (1-x)^{n-sr-k} \sum_{\mu=0}^s \binom{s}{\mu} x^\mu (1-x)^{s-\mu}.$$

When  $s = r = 0$ , the classical Bernstein operators are obtained. İbikli studied the Stancu generalisation of Bernstein-Chlodowsky polynomials in 2000. According to the this,  $r, s \in \mathbb{N} \cup \{0\}$  and for  $(b_n)$  satisfying the properties in (2)

$$C_{k,s}^*(f; x) = \sum_{k=0}^{n-sr} \binom{n-sr}{k} \left(\frac{x}{b_n}\right)^k \left(1 - \frac{x}{b_n}\right)^{n-sr-k} \sum_{\mu=0}^s \binom{s}{\mu} \left(\frac{x}{b_n}\right)^\mu \left(1 - \frac{x}{b_n}\right)^{s-\mu} \quad (3)$$

can be written as. For  $s = r = 0$ , we get Bernstein-Chlodowsky operators.

Let  $x \in \mathbb{R}^{+,0}$  and  $f \in C(\mathbb{R}^{+,0})$ . The modified Szasz-Mirakjan operators, denoted by  $\mathfrak{S}_n(f; \xi_n, \zeta_n, x) = \mathfrak{S}_n(f; x)$ , are defined as

$$\mathfrak{S}_n(f; x) = e^{-\xi_n x} \sum_{k=0}^{\infty} \frac{(\xi_n x)^k}{k!} f\left(\frac{k}{\zeta_n}\right) \quad (4)$$

with  $(\xi_n)$  and  $(\zeta_n)$  being increasing and unbounded sequences of positive numbers, resulting in

$$\lim_{n \rightarrow \infty} \frac{1}{\zeta_n} = 0, \quad \lim_{n \rightarrow \infty} \frac{\xi_n}{\zeta_n} = 1 + O\left(\frac{1}{\zeta_n}\right). \quad (5)$$

In (Walczak 2000), Walczak presented the modified Szasz-Mirakjan operators in the polynomial

weighted spaces of functions of one and two variables. He examined the approximation properties of the modified Szasz-Mirakjan operators in the weighted space of continuous functions of two variables, where  $\rho f$  is uniformly continuous and bounded on  $\mathbb{R}^{+,2} = \mathbb{R}^{+,0} \times \mathbb{R}^{+,0}$ , and  $\rho(x, y)$  is a polynomial weight function. In (İspir and Atakut 2002), İspir and Atakut investigated theorems on the convergence of  $\mathfrak{S}_n(f; x)$ , defined by (1), to  $f(x)$  in the weighted spaces of continuous functions. They obtained the convergence rate of the operators using the weighted modulus of continuity for all positive semi-axes and studied the modified Szasz-Mirakjan operators in the polynomial weighted spaces for functions of two variables. In (Gazanfer and Büyükyazıcı 2014) Büyükyazıcı and Gazanfer investigated the weighted approximation properties of the operator in hybrid form for operators (1) and (3) in two variables.

## MATERIAL AND METHODS

### Material

In our research, we have been motivated by the work of operators (3) and (4) to examine specific linear positive operators that apply to functions of two variables. For this purpose, let  $f \in C(\blacksquare_{b_n})$ , where

$$\blacksquare_{b_n} = \{(x, y) \mid 0 \leq x \leq b_n, 0 \leq y \leq \infty\}$$

and define the linear positive operators

$$\mathcal{L}_{k,\mu,j}(f; x, y) = \sum_{k=0}^{n-sr} \sum_{\mu=0}^s \sum_{j=0}^{\infty} Q_{n-sr,k} \left( \frac{x}{b_n} \right) Q_{s,\mu} \left( \frac{x}{b_n} \right) W_j(\xi_m y) f \left( \frac{k + \mu r}{n} b_n, \frac{j}{\zeta_m} \right) \quad (6)$$

with  $Q_{n-sr,k}(x) = \binom{n-sr}{k} x^{n-sr-k} (1-x)^{n-sr-k}$ ,  $Q_{s,\mu}(x) = \binom{s}{\mu} x^\mu (1-x)^{s-\mu}$  and  $W_j(x) = e^{-x} \frac{x^j}{j!}$ . By selecting  $f(x, y) := g(x)$ , we obtain Chlodowsky-type operators; by selecting  $f(x, y) := h(y)$ , we obtain Szasz-type operators.

### Methods

In this paper, we initially examine the approximation properties of the sequence of linear positive operators defined by (6) within the space of continuous functions on the compact set  $\blacksquare_{AB} = [0, A] \times [0, B]$ . Our investigation reveals the order of this approximation, which is determined using the full and partial moduli of continuity, respectively. Lastly, we explore the convergence of the sequence of linear positive operators  $\mathcal{L}_{k,\mu,j}$  that are defined on a weighted space of functions with two variables. We establish the rate of convergence for this sequence by employing the weighted modulus of continuity.

### Approximation Properties on $\blacksquare_{AB}$

In this section, we present certain classical approximation properties of the operators  $\mathcal{L}_{k,\mu,j}$  with respect to the compact set  $\blacksquare_{AB}$ .

Let  $e_{\alpha,\beta}(\tau_1, \tau_2) = \tau_1^\alpha \tau_2^\beta$ . One may easily derive the following lemmas through straightforward calculations.

**Lemma 1.** Let  $\mathcal{L}_{k,\mu,j}$  be defined by (6). Then there is one for all  $m, n, s, r \in \mathbb{N}$ ,

$$\mathcal{L}_{k,\mu,j}(e_{0,0}; x, y) = 1 \quad (7)$$

$$\mathcal{L}_{k,\mu,j}(e_{1,0}; x, y) = x \quad (8)$$

$$\mathcal{L}_{k,\mu,j}(e_{0,1}; x, y) = \frac{\xi_m}{\zeta_m} y \quad (9)$$

$$\mathcal{L}_{k,\mu,j}(e_{2,0}; x, y) = \frac{x(xn^2 - xn + xsr + b_n n - b_n sr - r^2 sx + r^2 s b_n)}{n^2} \quad (10)$$



$$\mathcal{L}_{k,\mu,j}(e_{0,2}; x, y) = \frac{\xi_m^2}{\zeta_m^2} y^2 + \frac{\xi_m}{\zeta_m} y \quad (11)$$

$$\mathcal{L}_{k,\mu,j}(e_{3,0}; x, y) = \frac{x(3x^2nsr + 3xb_nsr - 3x^2r^2sn - 3r^3sxb_n + x^2n^3 - 3x^2n^2 + 2x^2n + b_n^2n - 3xb_nnsr)}{n^3} + \frac{x(3xr^2snb_n - 2x^2sr + 3xb_nn^2 - 3xb_nn - b_n^2sr + 2r^3sx^2 + r^3sb_n^2)}{n^3}$$

$$\mathcal{L}_{k,\mu,j}(e_{0,3}; x, y) = \frac{\xi_m^3}{\zeta_m^3} y^3 + \frac{3\xi_m^2}{\zeta_m^3} y^2 + \frac{\xi_m}{\zeta_m^3} y$$

$$\mathcal{L}_{k,\mu,j}(e_{4,0}; x, y) = \frac{x(sb_n^3 + 11x^3s^2r^2 + 12x^3s^3r^3 + 8x^3s^4r^4 + 6x^3sr + 10x^2b_nn^3 - 30x^2b_nn^2 + 20x^2b_nn)}{n^4} + \frac{x(15xb_n^2n^2 - 15xb_n^2n - b_n^3sr - 12x^3r^4s^3 - 6x^3r^3s^3 - 4r^4s^2b_n^3 + 11r^4s^2x^3 - 6r^4sx^3 - 6x^3n)}{n^4} + \frac{x(-6x^3n^3 + x^3n^4 + b_n^3n - 22x^3nsr + 18x^3n^2sr - 24x^3ns^2r^2 - 4x^3n^3sr + 12x^3n^2s^2r^2)}{n^4} + \frac{x(-16x^3ns^3r^3 - 12x^2b_ns^3r^3 - 26x^2b_ns^2r^2 - 20x^2b_nsr + 11xb_n^2s^2r^2 + 15xb_n^2sr)}{n^4} + \frac{x(-6x^3r^2sn^2 + 12x^3r^3s^2n + 6x^3r^2sn + 24x^2r^4s^3b_n + 12x^2r^3s^2b_n - 6xr^3s^2b_n^2)}{n^4} + \frac{x(4r^3sb_n^3n - 4r^4s^4b_nx^2 - 26r^4s^2b_nx^2 - 12r^4s^3b_n^2x + 19r^4s^2b_n^2x + 12r^4sx^2b_n)}{n^4} + \frac{x(-7r^4sxb_n^2 + 11x^3n^2 + 28x^2b_nns^2r^2 + 56x^2b_nnsr - 26xb_n^2nsr + 6x^2r^2sn^2b_n)}{n^4} + \frac{x(-24x^2r^3s^2nb_n - 12x^2r^2snb_n + 6xr^2snb_n^2 + 4r^3s^3b_nnx^2 + 8r^3sb_nx^2n + 12r^3s^2b_n^2nx)}{n^4} + \frac{x(-12r^3sb_n^2xn - 26x^2b_nn^2sr)}{n^4} \quad (12)$$

$$\mathcal{L}_{k,\mu,j}(e_{0,4}; x, y) = \frac{\xi_m^4}{\zeta_m^4} y^4 + \frac{6\xi_m^3}{\zeta_m^4} y^3 + \frac{7\xi_m^2}{\zeta_m^4} y^2 + \frac{\xi_m}{\zeta_m^4} y \quad (13)$$

**Lemma 2.** The following equations, as defined by equation (6), apply to the variables  $(x, y) \in \mathbb{R}^{+2}$  and  $n, m \in \mathbb{N}$ , and hold true for the operator  $\mathcal{L}_{k,\mu,j}$ :

$$\mathcal{L}_{k,\mu,j}((e_{1,0} - x)^2; x, y) = \left(\frac{sr - r^2s - n}{n^2}\right)x^2 + \left(\frac{b_n(n - sr + r^2s)}{n^2}\right)x$$

$$\mathcal{L}_{k,\mu,j}((e_{0,1} - y)^2; x, y) = \left(\frac{\xi_m}{\zeta_m} - 1\right)^2 y^2 + \left(\frac{\xi_m}{\zeta_m^2}\right)y$$

$$\mathcal{L}_{k,\mu,j}((e_{1,0} - x)^4; x, y) = \left(\frac{3n^2 - 4n^2sr - 6nsr + 3s^2r^2 + 6sr - 6n - 12r^3ns^2 + 3r^4s^2}{n^4}\right)x^4 + \left(\frac{-6r^4s - 6r^3s^3 - 6n^2r^2s + 12nr^3s^3 - 6nr^2s}{n^4}\right)x^4 + \left(\frac{-6n^2 + 12nsr - 12sr + 12n}{n^4}\right)x^3b_n + \left(\frac{-6nsr^2 + 6r^4s^3 - 18r^4s^2 + 12r^4s - 12ns - 12ns^2r^3 + 12nr^3s + 6n^2r^2s}{n^4}\right)x^3b_n + \left(\frac{3n^2 - 6nsr + 7sr + 3r^2s^2 - 7n + 12s^2 - 12s + 7r^4s^2 - 7r^4s - 4nr^3s}{n^4}\right)x^2b_n^2$$

$$\begin{aligned} & + \left( \frac{n - nsr + 6r^2s + 4s + r^4s}{n^4} \right) x b_n^3 \\ \mathcal{L}_{k,\mu,j} \left( (e_{0,1} - y)^4; x, y \right) & = \left( \frac{\xi_m^4}{\zeta_m^4} - \frac{4\xi_m^3}{\zeta_m^3} + \frac{6\xi_m^2}{\zeta_m^2} - \frac{4\xi_m}{\zeta_m} + 1 \right) y^4 + \left( \frac{6\xi_m^3}{\zeta_m^4} - \frac{12\xi_m^2}{\zeta_m^3} + \frac{6\xi_m}{\zeta_m^2} \right) y^3 \\ & + \left( \frac{7\xi_m^2}{\zeta_m^4} - \frac{4\xi_m}{\zeta_m^3} \right) y^2 + \frac{4\xi_m}{\zeta_m^3}. \end{aligned} \quad (14)$$

**Lemma 3.** The following equations, as defined by equation (6), apply to the variables  $(x, y) \in \mathbb{R}^{+,2}$  and large enough  $n, m$  and hold true for the operator  $\mathcal{L}_{k,\mu,j}$ :

$$\mathcal{L}_{k,\mu,j} \left( (e_{1,0} - x)^2; x, y \right) = O \left( \frac{b_n}{n} \right) (x^2 + x) \quad (15)$$

$$\mathcal{L}_{k,\mu,j} \left( (e_{0,1} - x)^2; x, y \right) = O \left( \frac{1}{\zeta_m} \right) (y^2 + y) \quad (16)$$

$$\mathcal{L}_{k,\mu,j} \left( (e_{1,0} - x)^4; x, y \right) = O \left( \frac{b_n}{n} \right) (x^4 + x^3 + x^2 + x) \quad (17)$$

$$\mathcal{L}_{k,\mu,j} \left( (e_{0,1} - x)^4; x, y \right) = O \left( \frac{1}{\zeta_m} \right) (y^4 + y^3 + y^2 + y). \quad (18)$$

The subsequent theorem demonstrates that the linear positive operator  $\mathcal{L}_{k,\mu,j}$ , as defined in (5), converges to  $f$  uniformly, as established by Theorem 4 presented by Volkov (Volkov 1957).

**Theorem 4.** The function  $f \in C(\mathbb{R}^{+,2})$ , and the operators  $\mathcal{L}_{k,\mu,j}$  defined by equation (6), converge uniformly to  $f$  on  $\blacksquare_{AB} \subset \mathbb{R}^{+,2}$  as  $n$  and  $m$  increase.

*Proof.* From (7)-(10) and conditions (2) and (5), we have

$$\begin{aligned} \lim_{n,m \rightarrow \infty} \left\| \mathcal{L}_{k,\mu,j}(e_{0,0}; x, y) - 1 \right\|_{C(\blacksquare_{AB})} & = 0, \\ \lim_{n,m \rightarrow \infty} \left\| \mathcal{L}_{k,\mu,j}(e_{1,0}; x, y) - x \right\|_{C(\blacksquare_{AB})} & = 0, \\ \lim_{n,m \rightarrow \infty} \left\| \mathcal{L}_{k,\mu,j}(e_{0,1}; x, y) - y \right\|_{C(\blacksquare_{AB})} & = 0, \\ \lim_{n,m \rightarrow \infty} \left\| \mathcal{L}_{k,\mu,j}(e_{1,0}^2 + e_{0,1}^2; x, y) - (x^2 + y^2) \right\|_{C(\blacksquare_{AB})} & = 0, \end{aligned} \quad (19)$$

By applying Theorem 4, we obtain the desired result.

The following theorem provides the convergence rate of the sequence of linear positive operators  $\mathcal{L}_{k,\mu,j}$  to  $f$  on  $\blacksquare_{AB} \subset \mathbb{R}^{+,2}$ , utilizing partial and full modulus of continuity.

**Theorem 5.** Let  $f \in C(\blacksquare_{AB})$ ; then the following inequalities hold:

$$\left\| \mathcal{L}_{k,\mu,j}(f; x, y) - f(x, y) \right\| \leq 2 \left[ \omega_f^{(1)}(\delta_n) + \omega_f^{(2)}(\delta_m) \right] \quad (20)$$

$$\left\| \mathcal{L}_{k,\mu,j}(f; x, y) - f(x, y) \right\| \leq 4\omega_f^{(1)}(\delta_{n,m}) \quad (21)$$

where

$$\delta_n = \frac{\sqrt{A(Asr + b_n n + r^2 s b_n)}}{n}, \quad \delta_m = \sqrt{B^2 \left( \frac{\xi_m^2}{\zeta_m^2} \right) + B \left( \frac{\xi_m}{\zeta_m} \right)}$$

and

$$\delta_{n,m} = \sqrt{\frac{A(Asr + b_n n + r^2 s b_n)}{n^2} + B^2 \left( \frac{\xi_m^2}{\zeta_m^2} \right) + B \left( \frac{\xi_m}{\zeta_m} \right)}.$$

*Proof.* Utilising the property of the partial modulus of continuity as outlined in (6) and (7), it is possible to express the result as

$$\begin{aligned}
 & |\mathcal{L}_{k,\mu,j}(f; x, y) - f(x, y)| \\
 & \leq \sum_{k=0}^{n-sr} \sum_{\mu=0}^s \sum_{j=0}^{\infty} Q_{n-sr,k} \left( \frac{x}{b_n} \right) Q_{s,\mu} \left( \frac{x}{b_n} \right) W_j(\xi_m y) \left| f \left( \frac{k+\mu r}{n} b_n, \frac{j}{\zeta_m} \right) - f \left( x, \frac{j}{\zeta_m} \right) \right| \\
 & + \sum_{k=0}^{n-sr} \sum_{\mu=0}^s \sum_{j=0}^{\infty} Q_{n-sr,k} \left( \frac{x}{b_n} \right) Q_{s,\mu} \left( \frac{x}{b_n} \right) W_j(\xi_m y) \left| f \left( x, \frac{j}{\zeta_m} \right) - f(x, y) \right| \\
 & \leq \omega_f^{(1)}(\delta_n) \left[ 1 + \frac{1}{\delta_n} \sum_{k=0}^{n-sr} \sum_{\mu=0}^s Q_{n-sr,k} \left( \frac{x}{b_n} \right) Q_{s,\mu} \left( \frac{x}{b_n} \right) \left| \frac{k+\mu r}{n} b_n - x \right| \right] \\
 & + \omega_f^{(2)}(\delta_m) \left[ 1 + \frac{1}{\delta_m} \sum_{j=0}^{\infty} W_j(\xi_m y) \left| \frac{j}{\zeta_m} - y \right| \right];
 \end{aligned}$$

Applying the Cauchy-Schwarz inequality, we have

$$\begin{aligned}
 & |\mathcal{L}_{k,\mu,j}(f; x, y) - f(x, y)| \\
 & \leq \omega_f^{(1)}(\delta_n) \left[ 1 + \frac{1}{\delta_n} \left( \sum_{k=0}^{n-sr} \sum_{\mu=0}^s Q_{n-sr,k} \left( \frac{x}{b_n} \right) Q_{s,\mu} \left( \frac{x}{b_n} \right) \left( \frac{k+\mu r}{n} b_n - x \right)^2 \right)^{1/2} \right] \\
 & + \omega_f^{(2)}(\delta_m) \left[ 1 + \frac{1}{\delta_m} \left( \sum_{j=0}^{\infty} W_j(\xi_m y) \left( \frac{j}{\zeta_m} - y \right)^2 \right)^{1/2} \right];
 \end{aligned}$$

and using equalities (10) and (11), choosing

$$\delta_n = \frac{\sqrt{A(Asr + b_n n + r^2 s b_n)}}{n}, \quad \delta_m = \sqrt{B^2 \left( \frac{\xi_m^2}{\zeta_m^2} \right) + B \left( \frac{\xi_m}{\zeta_m} \right)},$$

we obtain inequality (20). If we use inequality

$$\omega_f^{(1)}(\delta) + \omega_f^{(2)}(\delta) \leq 2\omega_f(\delta)$$

we can easily obtain inequality (21). Thus, the proof of theorem is completed.

**Example 6.** For  $n, m = 50, n, m = 80$  and  $b_n = \sqrt{n}$ ,  $\xi_m = m$ ,  $\zeta_m = m + \sqrt{m}$ ; the convergence of  $\mathcal{L}_{k,\mu,j}(f; x, y)$  to  $f(x, y) = 1 - x^2 + (y - 1)^2$  is illustrated in Figure 1,2.

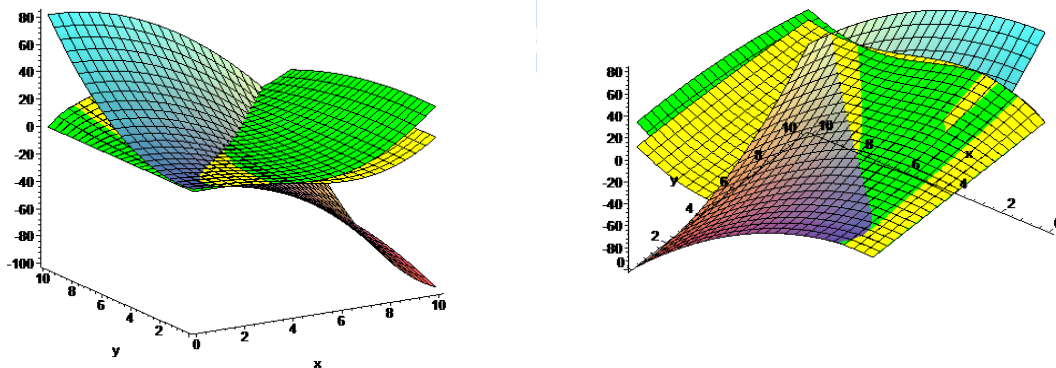


Figure 1,2: The convergence of  $\mathcal{L}_{k,\mu,j}(f; x, y)$  to  $f(x, y)$  for  $n, m = 50, n, m = 80$



**Weighted Approximation Properties of  $\mathcal{L}_{k,\mu,j}$**

In the present section, we aim to examine the convergence traits of the  $L$  operators as defined in equation (6) in the context of continuous functions on the positive semiaxis, utilizing the weighted Korovkin theorem. The Korovkin theorem, which pertains to weighted spaces and applies to linear positive operators  $T$  acting from  $C$  to  $B$ , has been established by Gadjiev (Gadjiev 1980).

**Theorem 7.** A series of positive linear operators, denoted by  $Y_{n,m}$ , exist that act from the set  $C_\rho(\mathbb{R}^{+,2})$  to the set  $B_\rho(\mathbb{R}^{+,2})$  and fulfill the specified criteria

$$\lim_{n,m \rightarrow \infty} \|Y_{n,m}(1; x, y) - 1\|_\rho = 0, \quad (22)$$

$$\lim_{n,m \rightarrow \infty} \|Y_{n,m}(\tau_1; x, y) - x\|_\rho = 0, \quad (23)$$

$$\lim_{n,m \rightarrow \infty} \|Y_{n,m}(\tau_2; x, y) - y\|_\rho = 0, \quad (24)$$

$$\lim_{n,m \rightarrow \infty} \|Y_{n,m}(\tau_1^2 + \tau_2^2; x, y) - (x^2 + y^2)\|_\rho = 0. \quad (25)$$

Then there exists a function  $f_* \in C_\rho(\mathbb{R}^{+,2})$  for which

$$\lim_{n,m \rightarrow \infty} \|Y_{n,m}f_* - f_*\|_\rho \geq 1.$$

**Theorem 8.** Let  $Y_{n,m}$  be a sequence of positive linear operators acting from the set  $C_\rho(\mathbb{R}^{+,2})$  to the set  $B_\rho(\mathbb{R}^{+,2})$  and let  $\rho_1(x, y) \geq 1$  be a continuous function for which

$$\lim_{|\vartheta| \rightarrow \infty} \frac{\rho(\vartheta)}{\rho_1(\vartheta)} = 0, \quad \text{where } \vartheta = (x, y).$$

The conditions (22)-(25) imply

$$\lim_{n,m \rightarrow \infty} \|Y_{n,m}f - f\|_{\rho_1} = 0$$

for all  $f \in C_\rho(\mathbb{R}^{+,2})$ .

We present the following outcomes in (Gadjiev 1980 and Gadjiev, Hacısalihoğlu 1995), which are utilized in the demonstrations of our primary theorems.

**Theorem 9.** Let  $\mathcal{L}_{k,\mu,j}$  be the sequence of linear positive operators defined by (6). Then for all  $C_\rho(\mathbb{R}^{+,2})$  one has

$$\lim_{n,m \rightarrow \infty} \|\mathcal{L}_{k,\mu,j}f - f\|_{\rho_1} = 0$$

where  $\rho(x, y) = 1 + x^2 + y^2$  and  $\rho_1(x, y)$  is the continuous function, satisfying the condition

$$\lim_{|v| \rightarrow \infty} \frac{\rho(v)}{\rho_1(v)} = 0 \quad (\text{where } v = (x, y) \text{ and } \rho_1(x, y) \geq 1).$$

*Proof.* Firstly let us show that  $\mathcal{L}_{k,\mu,j}$  is acting from  $C_\rho(\mathbb{R}^{+,2})$  to  $\mathcal{B}_\rho(\mathbb{R}^{+,2})$ . Using (7), (10) and (11) we write

$$\begin{aligned} & \|\mathcal{L}_{k,\mu,j}(\rho; x, y)\|_\rho \\ & \leq 1 \\ & + \sup_{(x,y) \in \mathbb{R}^{+,2}} \left[ \left( \frac{n^2 - n + sr - r^2s}{n^2} \right) \frac{x^2}{1 + x^2 + y^2} + \frac{b_n}{n} \left( \frac{n - sr + r^2s}{n} \right) \frac{x}{1 + x^2 + y^2} \right] \\ & + \sup_{(x,y) \in \mathbb{R}^{+,2}} \left[ \frac{\xi_m^2}{\zeta_m^2} \frac{y^2}{1 + x^2 + y^2} + \frac{\xi_m}{\zeta_m^2} \frac{y}{1 + x^2 + y^2} \right] \end{aligned}$$

$$\leq 1 + \frac{b_n}{n} + \frac{\xi_m^2}{\zeta_m^2} + \frac{\xi_m}{\zeta_m} \leq 1 + \vartheta_{n,m}$$

where  $\vartheta_{n,m} = \frac{b_n}{n} + \frac{\xi_m^2}{\zeta_m^2} + \frac{\xi_m}{\zeta_m}$ . Since  $\vartheta_{n,m} \rightarrow 0$  as  $n, m \rightarrow \infty$ , there is a positive constant  $M$  such that  $\vartheta_{n,m} < M$  for all natural numbers  $n$  and  $m$ . Hence we have

$$\|\mathcal{L}_{k,\mu,j}(\rho; x, y)\|_{\rho} \leq 1 + M.$$

We have  $\mathcal{L}_{k,\mu,j}: C_{\rho}(\mathbb{R}^{+,2}) \rightarrow \mathcal{B}_{\rho}(\mathbb{R}^{+,2})$ .

Finally, using (10) and (11), we have

$$\|\mathcal{L}_{k,\mu,j}(t_1^2 + t_2^2; x, y) - (x^2 + y^2)\|_{\rho} \leq \vartheta_{n,m},$$

where  $\vartheta_{n,m} = \left(\frac{b_n}{n}\right) + \left(\frac{\xi_m^2}{\zeta_m^2}\right) + \left(\frac{\xi_m}{\zeta_m}\right)$  and  $\vartheta_{n,m} \rightarrow 0$  as  $n, m \rightarrow \infty$ . Thus we obtain the desired result.

### References

- Gadjiev AD, Efendiev RO, İbikli E, 1998. Generalized Bernstein-Chlodowsky polynomials. The Rocky Mountain Journal of Mathematics, vol.28, pp. 1267-1277.
- Gadjieva EA, İbikli E, 1995. On generalization of Bernstein-Chlodowsky polynomials. Hacettepe Bulletin of Natural Sciences and Engineering, vol.24, pp. 31-34.
- Gazanfer AK, Büyükyazıcı İ, 2014. Approximation by certain linear positive operators of two variables. Abstract and Applied Analysis, vol.2014.
- Stancu DD, 1998. The remainder in the approximation by a generalized Bernstein operator: a representation by a convex combination of second-order divided differences. Calcolo, vol.35, pp.53-62.
- Kajla A, 2019. Generalized Bernstein-Kantorovich-type operators on a triangle. Mathematical Methods in the Applied Sciences, vol.42, pp. 4365-4377.
- İbikli E, 2000. On Stancu type generalization of Bernstein-Chlodowsky polynomials. Mathematica, vol.65, pp. 37-43.
- Gadjiev AD, 1980. Linear positive operators in weighted space of functions of several variables. N4, Izvestiya Academy of Sciences of Azerbaijan.
- Gadjiev AD, Hacısalihoğlu H, 1995. Convergence of the sequences of linear positive operators. Ankara University Press.
- Walczak Z, 2000. On certain modified Szasz-Mirakyan operators for functions of two variables. Demonstratio Mathematica, vol.33, pp. 91-100.
- İspir N, Atakut Ç, 2002. Approximation by modified Szasz-Mirakyan operators on weighted spaces. Proceedings of the Indian Academy of sciences: Mathematical Sciences, vol.112, pp. 571-578.
- Volkov VI, 1957. On the convergence of sequences of linear positive operators in the space of continuous functions of two variable. Matematicheskii Sbornik, vol.43, pp. 504.

### Conflict of Interest

The authors declare that there is no conflict of interests regarding the publication of this paper.

## Detection of Obesity Levels Using Artificial Intelligence Methods

**Aynur Yonar\***

Selcuk University, Faculty of Science, Department of Statistics, 42031, Konya, Türkiye

\*Corresponding author e-mail: aynursahin@selcuk.edu.tr

### Abstract

*Obesity is a common disease worldwide, affecting all age groups and genders. Therefore, researchers are making great efforts to identify its early causes. In this study, various machine learning algorithms such as Decision-Tree, Random Forest, and Light Gradient Boosting Machine-Classifer were used to detect obesity levels using the data set containing obesity levels of individuals in Mexico, Peru, and Colombia according to their eating habits and physical conditions. As a result, the classification performances of these algorithms are presented comparatively.*

**Keywords:** Artificial Intelligence, Classification, Machine Learning, Obesity Detection.

### INTRODUCTION

Obesity is a multifactorial disease characterized by uncontrolled weight gain resulting from low physical activity and high caloric consumption, leading to abnormal or excessive deposition of fat that has the potential to severely impact health (Yagin et al., 2023). People with a body mass index (BMI) above 30 are categorized as obese, whereas individuals with a BMI ranging from 25 to 30 fall into the overweight category. It is recognized as the most significant health issue of the 21st century. Obesity causes numerous problems across various domains, including health, demographics, labor, family dynamics, and economics (Apovian, 2016; Gozukara Bag et al., 2023).

From a health perspective, obesity markedly elevates the risk of chronic diseases. It correlates with a higher occurrence of cardiovascular disease, various cancers (including breast, prostate, kidney, ovarian, liver, and colon cancers), hypertension, musculoskeletal disorders, stroke, metabolic syndrome, type 2 diabetes (because of heightened insulin resistance), Alzheimer, and kidney disease (Blüher, 2019; Gozukara Bag et al., 2023). In 2022, 2.5 billion adults aged 18 years and older were classified as overweight, including over 890 million adults living with obesity. This indicates that 43% of adults aged 18 years and older (43% of men and 44% of women) are overweight, marking a notable rise from 1990, when 25% of adults in this age bracket were overweight. (WHO, 2024).

Identifying changeable obesity risk factors at both individual and population levels is crucial for developing efficient risk reduction strategies. (Solomon et al., 2023). Many studies have investigated improved methods to predict obesity using existing data. These studies have utilized data accessibility and availability to enhance prediction accuracy. As machine learning represents a pioneering innovation capable of deriving in-depth insights from data through various mathematical and statistical techniques, numerous machine learning-based models have been developed to predict and classify obesity at an early stage. Yagin et al. (2023) utilized a trained neural network model to predict obesity levels based on physical activity and eating habits. Solomon et al. (2023) devised a hybrid modeling approach based on majority voting, incorporating a gradient boosting classifier, extreme gradient boosting, and a multilayer perceptron. Jindal, Baliyan, and Rana (2018) introduced a hybrid strategy for obesity prediction with ensemble machine learning. Rodríguez, Rodríguez, Nascimento, da Silva, and Marins (2021) proposed a machine learning strategy for predicting obesity or overweight status. Cui, Chen, Wang, Deng, and Huang (2021) estimated obesity levels based on eating habits, physical condition, and other factors using three prediction models: Decision Trees, Logistic Regression, and K-Nearest Neighbor.



The objective of this study is to use machine learning classification and feature selection techniques to categorize obesity levels based on survey data identifying individuals with obesity and overweight. The collected data, which focus on physical condition and dietary habits, aim to facilitate timely decision-making.

The rest of this study is structured as follows: In Section 2, the data, the machine learning classification algorithms, and feature selection method used in the study are explained. In Section 3, classification algorithms are applied to obesity data. Finally, the results are presented in the conclusion part.

## **MATERIAL AND METHODS**

### **Material**

#### **Random Forest Classifier**

The Random Forest classifier comprises a combination of multiple tree classifiers, each created using a random subset of features independently sampled from the input vector. Each tree contributes a single vote for the predominant class to classify an input vector. This algorithm is fast and relatively robust to outliers and noise, and it operates efficiently on large datasets. A significant advantage of Random Forest is its resilience to overfitting, even when additional trees are added to the forest (Chaudhary, Kolhe, & Kamal, 2016; Pal, 2005).

#### **Extreme Gradient Boosting**

Extreme Gradient Boosting (XGB) is an ensemble method based on trees, utilizing a gradient boosting machine learning framework to effectively address regression and classification challenges. XGBoost builds trees using a depth-wise algorithm, where each iteration of the training process adds new trees to predict the residuals or errors left by previous trees. These predicted residuals are then integrated with the predictions from earlier trees to produce the final machine-learning model. (Alzanzami, Hoda, & El Saddik, 2020; Reddy & Priya, 2023).

#### **Light Gradient Boosting Machine Classifier**

Light Gradient Boosting Machine (LGBM), a gradient boosting algorithm, employs a leaf-wise tree growth strategy, selecting the leaf that minimizes loss for splitting. It utilizes a histogram-based method to identify optimal split candidates and applies the Gradient-based One-Side Sampling (GOSS) algorithm to prioritize data instances with larger gradients, assuming those with smaller gradients are already well-trained. This approach enhances training speed, reduces memory usage, improves accuracy, and enables efficient analysis of large datasets. LGBM is widely favored for regression and classification tasks due to its reputation for speed, memory efficiency, and effective handling of categorical data (Alzanzami et al., 2020; Luo, Liu, & He, 2023).

#### **Cat Boost Classifier**

CatBoost focuses on handling categorical features efficiently and boosting trees using an ordering principle that avoids conversion errors. Unlike some methods, CatBoost does not use binary replacement for categorical values. Instead, it randomly permutes the dataset and computes the average label value for examples with the same category value placed before the current one. This approach helps reduce overfitting and loss function in each iteration, improving model generalization and maximizing data utilization (Swetha et al., 2024).

#### **Decision Tree**

Decision tree creates a tree-like structure for classification. It iteratively partitions the dataset into smaller subsets based on specific criteria, ultimately forming a tree where each node classifies the data into one of the classes below it. The leaf nodes represent the final outcomes, while the intermediate

nodes serve as classifiers (Swetha et al., 2024).

### Gradient Boosting

The Gradient Boost classifier sequentially adds weak learners to the model, each focusing on the errors of the previous ones. It assigns weights to observations to highlight misclassified points and adjusts them during training. The algorithm minimizes prediction errors by combining the best next model with its past models, aiming to find parameter values that minimize a cost function (Jangiti, Paluri, Vadlamani, & Jindal, 2023; Sarkar et al., 2023).

### Recursive feature elimination with cross validation

Feature selection involves choosing relevant features or a subset of features. Evaluation criteria are used to select the best feature subset. In high-dimensional data, finding the optimal subset is challenging due to the large number of potential solutions ( $2^n$  for a dataset with  $n$  features). This task becomes even more complex as the number of features increases, which is common with advances in data collection and problem complexity (Kohavi & John, 1997; Kumar & Minz, 2014). This study used Recursive feature elimination with cross validation.

Recursive Feature Elimination (RFE) is an approach to feature selection where an external estimator assigns weights to features, akin to coefficients in a linear model. It iteratively selects features by progressively evaluating smaller subsets, starting from the complete set and discarding the least significant features until the desired number is achieved. (Misra & Yadav, 2020).

Recursive Feature Selection with Cross Validation (RFECV) extends RFE by performing feature selection within a cross-validation loop to find the optimal number of features. It automatically tunes the number of selected features by evaluating the RFE selector on different cross-validation splits and selecting the number of features that maximizes the cross-validation score (Nie, Wu, Ren, & Tan, 2023).

### Methods

#### *The Collection of the Data*

The dataset, received from Palechor and de la Hoz Manotas (2019), comprising data from individuals in Mexico, Peru, and Colombia is analyzed to detect levels of obesity based on their dietary habits and physical condition. The dataset contains 17 attributes and 2111 records, which are labeled with the class variable NObesity (Obesity Level), allowing classification using the values Underweight, Normal Weight, Overweight Level I, Overweight Level II, Obesity Type I, Obesity Type II, and Obesity Type III. 77% of the data was synthetically generated using the Weka tool and the SMOTE filter, while 23% of the data was collected directly from users through a survey study. The distribution of obesity levels in the data set is presented in Figure 1, and it is observed that there is a balanced distribution.

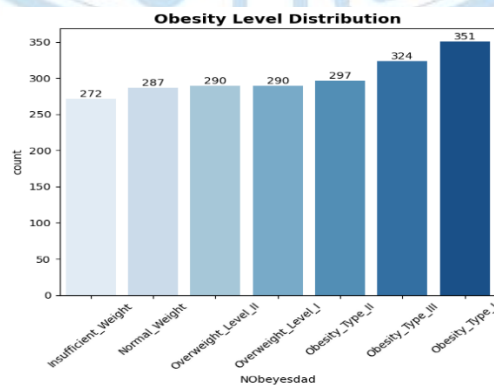


Figure 1. Distribution of obesity levels in the dataset

Statistical Analysis

To assess the performance of the machine learning algorithms, confusion matrices were employed along with precision, recall, accuracy, and F1-score values. These metrics were calculated using the following formulas.

$$Recall = \frac{TP}{TP + FN}$$

$$Accuracy = \frac{TP + TN}{TP + FP + TN + FN}$$

$$Precision = \frac{TP}{TP + FP}$$

$$F1 - score = 2 \times \frac{Precision \times Recall}{Precision + Recall}$$

Here, TP represents the number of true positive predictions. TN represents true negative predictions, FP represents false positive predictions, and FN represents false negative predictions.

RESULTS

An 80-20 split was utilized for the dataset, allocating 80% for training and the remaining 20% for testing. This study applied machine learning methods for classification, incorporating recursive feature selection with cross-validation.

The implementation is conducted using the Python programming language. The machine learning classification results are presented in Figure 2 with confusion matrix, while performance metrics are summarized in Table 1, and ROC curves are illustrated in Figure 3.

The confusion matrix is an essential tool for evaluating the performance of models in classification problems. In general, each model in Figure 1 performs well in certain classes, but specific errors are observed in some classes. Based on the confusion matrix, the performance metrics in Table 1 were calculated. As shown in Table 1, the LGBM classifier achieves the highest classification success according to all performance metrics. It is followed by XGB, CatBoost, RF, GB, and DT, respectively. The lowest classification success was observed with the DT classifier.

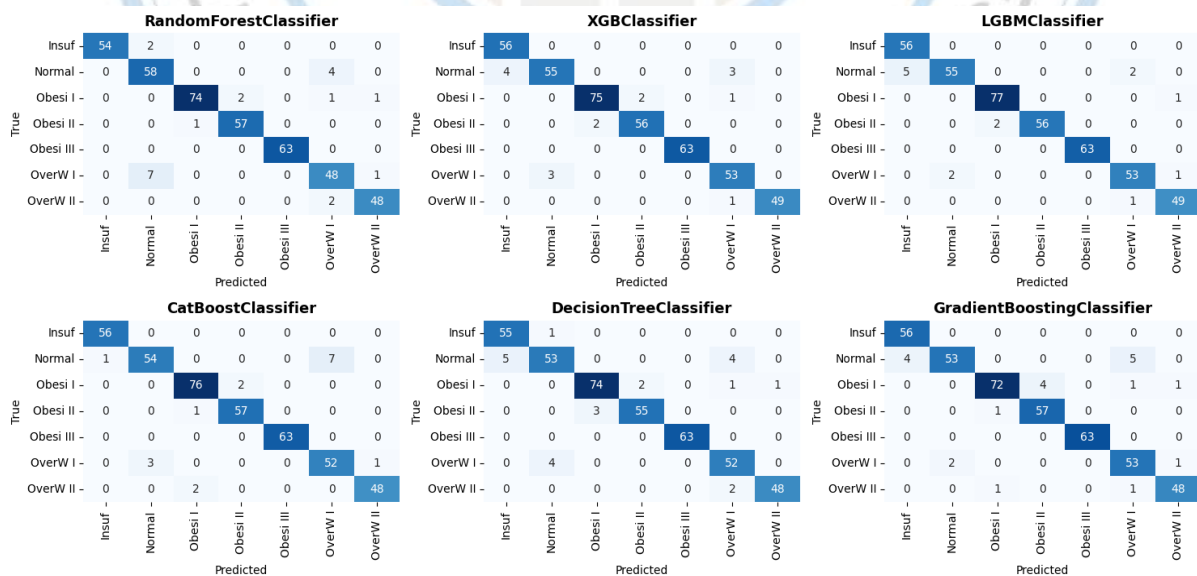
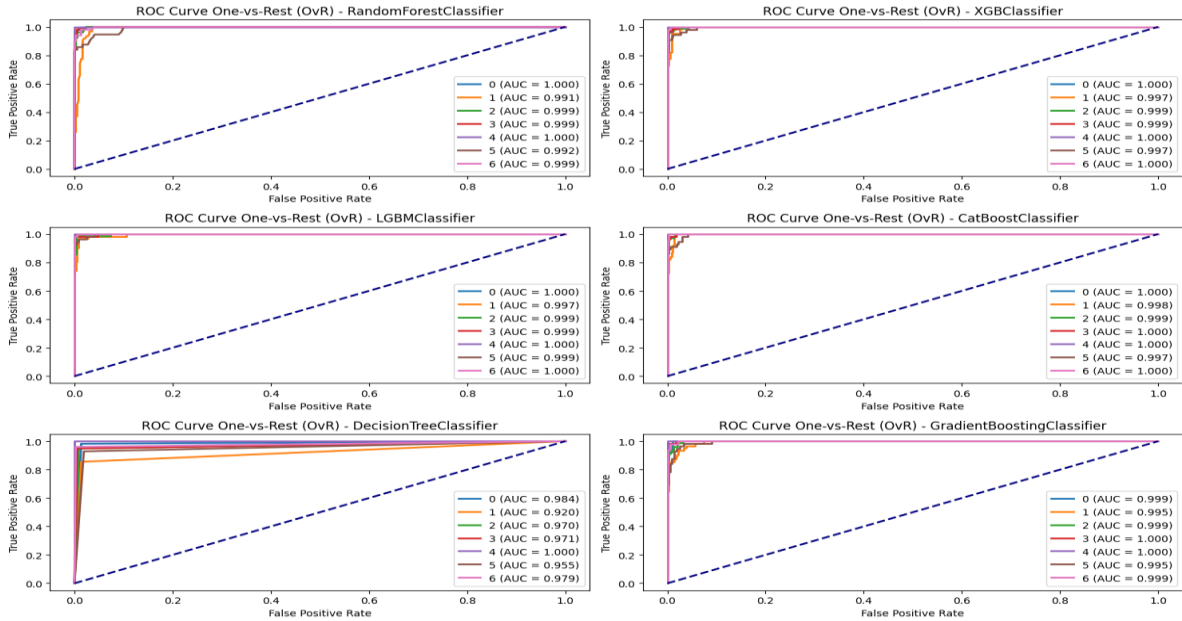


Figure 1. Confusion matrix for ML classification



**Table 1.** Performance metrics of ML classification algorithms

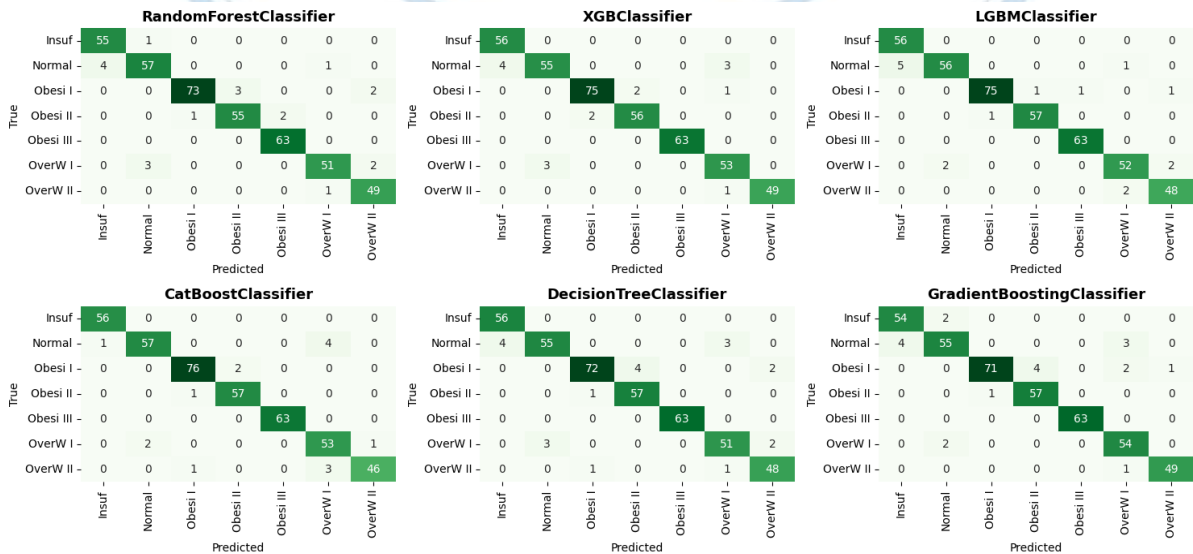
Model	Recall	Accuracy	Precision	F1_score
<b>RF</b>	0.9503	0.9503	0.9516	0.9506
<b>XGB</b>	0.9621	0.9621	0.9626	0.9620
<b>LGBM</b>	<b>0.9669</b>	<b>0.9669</b>	<b>0.9676</b>	<b>0.9667</b>
<b>Cat Boost</b>	0.9598	0.9598	0.9601	0.9596
<b>DT</b>	0.9456	0.9456	0.9462	0.9455
<b>GB</b>	0.9503	0.9503	0.9516	0.9500



**Figure 3.** ROC Curves for ML classification

The Area Under the ROC Curve (AUC) summarizes the performance of the model. Since the AUC value in the Figure 3 is between 0.9 and 1, we can say that the performance of the models is excellent.

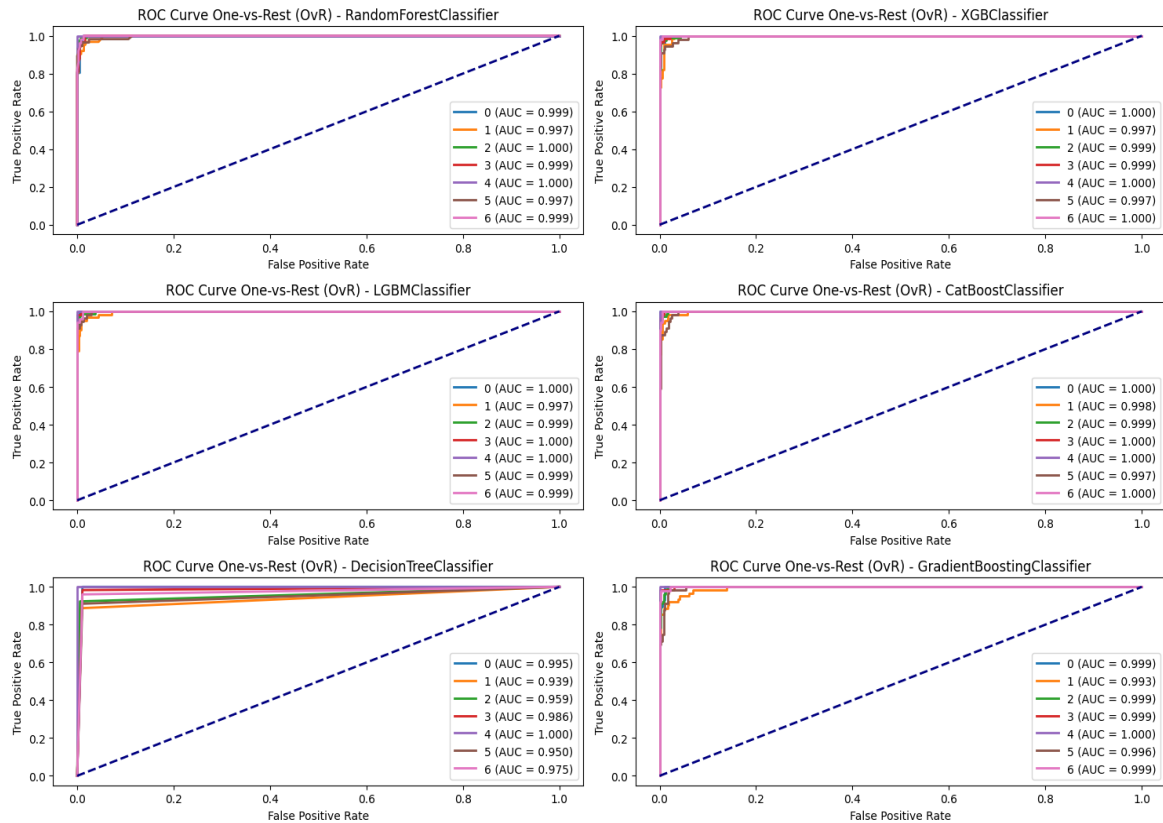
The machine learning with RFECV classification results are presented in Figure 4 with confusion matrix, while performance metrics are summarized in Table 2, and ROC curves are illustrated in Figure 5.



**Figure 4.** Confusion matrix for ML classification with Recursive feature selection.

**Table 2.** Performance metrics of ML classification algorithms with RFECV

Model	Numbers of Selected Features	Selected Features	Recall	Accuracy	Precision	F1_score
RF	2	Height, Weight	0.9527	0.9527	0.9533	0.9525
XGB	16	Age, Gender, Height, Weight, CALC,FAV,FCVC, NCP, SCC, SMOKE, CH2O,family_history_with_overweight, FAF, TUE, CAEC, MTRANS	0.9621	0.9621	0.9626	0.9620
LGBM	9	Age, Height, Weight, FCVC, NCP, CH2O, FAF, TUE, CAEC	0.9621	0.9621	0.9628	0.9620
Cat Boost	10	Age, Gender, Height, Weight, CALC, FCVC, NCP,CH2O	<b>0.9645</b>	<b>0.9645</b>	<b>0.9653</b>	<b>0.9645</b>
DT	3	Gender, Height, Weight	0.9503	0.9503	0.9508	0.9500
GB	9	Age, Gender, Height, Weight, CALC,FCVC, NCP, CH2O, CAEC	0.9527	0.9527	0.9537	0.9526



**Figure 5.** ROC Curves for ML classification with Recursive feature selection

Each model in Figure 4 performs well in certain classes, but specific errors are observed in some classes. Based on the confusion matrix, the performance metrics in Table 2 were calculated. As shown in Table 2, the CatBoost classifier achieves the highest classification success according to all performance metrics. It is followed by LGBM, XGB, GB, RF, and DT, respectively. The lowest classification success was observed with the DT classifier. Given that the AUC values in Figure 5 range between 0.9 and 1, it can be concluded that the performance of the models is excellent.

## DISCUSSION AND CONCLUSION

This research focuses on the implementation of machine learning classification algorithms to classify obesity levels. In addition to the classification techniques, recursive feature elimination with cross-validation (RFECV) is employed as a feature selection approach to identify significant features from an initial dataset comprising 17 features. The application of RFECV increased the classification success across all performance metrics for all algorithms except LGBM.

The study's findings reveal a notable improvement in the success rate of correct classification for all machine learning algorithms, except LGBM, when RFECV is applied for feature selection. However, the highest classification success was achieved with the LGBM algorithm without feature selection. Therefore, it may be recommended to use the LGBM classifier without feature selection for detecting obesity levels.

For future studies, it is recommended to explore different machine learning classification methods and feature selection techniques.

## References

- Alzamzami F, Hoda M, El Saddik A, 2020. Light gradient boosting machine for general sentiment classification on short texts: a comparative evaluation. *IEEE access*, 8, 101840-101858.
- Apovian CM, 2016. Obesity: definition, comorbidities, causes, and burden. *Am J Manag Care*, 22(7 Suppl), s176-185.
- Blüher M, 2019. Obesity: global epidemiology and pathogenesis. *Nature Reviews Endocrinology*, 15(5), 288-298.
- Chaudhary A, Kolhe S, Kamal R, 2016. An improved random forest classifier for multi-class classification. *Information Processing in Agriculture*, 3(4):215-222.
- Cui T, Chen Y, Wang J, Deng H, Huang Y, 2021. Estimation of Obesity levels based on Decision trees. Paper presented at the 2021 International Symposium on Artificial Intelligence and its Application on Media (ISAIAM).
- Gozukara Bag HG, Yagin FH, Gormez Y, González PP, Colak C, Gülu M, Ardigò LP, 2023. Estimation of obesity levels through the proposed predictive approach based on physical activity and nutritional habits. *Diagnostics*, 13(18): 2949.
- Jangiti J, Paluri CG, Vadlamani S, Jindal SK, 2023. Hepatitis C Severity Prognosis: A Machine Learning Approach. *Journal of Electrical Engineering Technology*, 18(4), 3253-3264.
- Jindal K, Baliyan N, Rana PS, 2018. Obesity prediction using ensemble machine learning approaches. Paper presented at the Recent Findings in Intelligent Computing Techniques: Proceedings of the 5th ICACNI 2017, Volume 2.
- Kohavi R, John GH, 1997. Wrappers for feature subset selection. *Artificial intelligence*, 97(1-2), 273-324.
- Kumar V, Minz SJS, 2014. Feature selection. 4(3): 211-229.
- Luo, H., Liu, J., & He, D. (2023). GNSS Signal Labeling, Classification and Positioning in Urban Scenes Based on PSO-LGBM-WLS Algorithm. *IEEE Transactions on Instrumentation Measurement*.
- Misra P, Yadav AS, 2020. Improving the classification accuracy using recursive feature elimination with cross-validation. *Int. J. Emerg. Technol*, 11(3): 659-665.
- Nie L, Wu R, Ren Y, Tan M, 2023. Research on fault diagnosis of HVAC systems based on the ReliefF-RFECV-SVM combined model. Paper presented at the Actuators.
- Pal M, 2005. Random forest classifier for remote sensing classification. *International journal of remote sensing*, 26(1): 217-222.
- Palechor FM, de la Hoz Manotas A, 2019. Dataset for estimation of obesity levels based on eating habits and physical condition in individuals from Colombia, Peru and Mexico. *Data in brief*, 25, 104344.
- Reddy AI, Priya, WD, 2023. An Efficient Fetal Health Prediction System Using Enhanced XGB Classifier Compared Over K-Nearest Neighbor Classifier with Less Complexity and Improved Accuracy. Paper presented at the 2023 Intelligent Computing and Control for Engineering and Business Systems (ICCEBS).
- Rodríguez E, Rodríguez E, Nascimento L, da Silva AF, Marins FAS, 2021. Machine learning



**V. INTERNATIONAL APPLIED STATISTICS CONGRESS (UYIK - 2024)**  
**İstanbul / Türkiye, May 21-23, 2024**

---

Techniques to Predict Overweight or Obesity. IDDM.

Sarkar T, Choudhury T, Bansal N, Arunachalaeshwaran V, Khayrullin M, Shariati MA, Lorenzo J M. , 2023. Artificial intelligence aided adulteration detection and quantification for red chilli powder. Food Analytical Methods, 16(4): 721-748.

Solomon DD, Khan S, Garg S, Gupta G, Almjally A, Alabduallah BI, Abdallah AMA, 2023. Hybrid Majority Voting: Prediction and Classification Model for Obesity. Diagnostics, 13(15), 2610.

Swetha T, Roopa R, Sajitha T, Vidhyashree B, Sravani J, Praveen B, 2024 . Forecasting Online Shoppers Purchase Intentions with Cat Boost Classifier. Paper presented at the 2024 International Conference on Distributed Computing and Optimization Techniques (ICDCOT).

WHO, 2024. Obesity and overweight. Access address: <https://www.who.int/news-room/fact-sheets/detail/obesity-and-overweight>; Date of access:14.04.2024.

Yagin FH, Güllü M, Gormez Y, Castañeda-Babarro A, Colak C, Greco G, Cataldi S, 2023 . Estimation of obesity levels with a trained neural Network Approach optimized by the bayesian technique. Applied Sciences, 13(6), 3875.



## The Correlation between Characteristic Parameters of the February 6th Elbistan Earthquake and Displacement Demand of Reinforced Concrete Systems

**Semra ŞİRİN KIRIŞ<sup>1\*</sup>, Eda UĞUR<sup>1</sup>**

<sup>1</sup> Doğuş University, Faculty of Engineering, Civil Engineering Department, 34775, İstanbul, Türkiye

\*Corresponding author e-mail: ssirin@dogus.edu.tr

### Abstract

*This study evaluates the ground motion parameters to estimate the structural damage potential of the February 6th Elbistan Earthquake. For this purpose, the peak displacement of reinforced concrete single-degree-of-freedom systems is obtained using earthquake records. By conducting numerous nonlinear time history analyses, correlation coefficients are calculated between the ground motion parameters and the peak displacement. Four selected parameters are related to the energy content, duration, or peak values of the ground motion records. The observation of the correlation coefficients shows that different earthquake parameters play a role in peak displacement demand according to the structural features. When considering the entire systems, the correlation coefficients for the Maximum Incremental Velocity parameter (MIV) are closer to 1. Therefore, the MIV earthquake parameter may be evaluated as more stable.*

**Keywords:** Earthquake parameters, Correlation coefficient, Seismic demand, Time history analysis.

### INTRODUCTION

In this study, the influence of ground motion characteristics on the behavior of reinforced concrete (RC) frames is investigated for February 6th Elbistan Earthquake. For this aim, four parameters reflecting earthquakes vulnerability are taken into account. These are PGA (Peak Ground Acceleration), MIV (Maximum Incremental Velocity), AI (Arias Intensity) and  $D_E$  (Effective Duration). Fifteen earthquake records from East-west direction records of February 6th Elbistan Earthquake with PGA values exceeding 0.1g are considered. Nonlinear time history analyses using the earthquake records are conducted for 27 RC single-degree-of-freedom (SDOF) systems formed by 9 initial periods and 3 strength ratios. The correlation coefficients between the ground motion parameters and peak displacement demand for each SDOF systems are calculated. Observing the correlation coefficients between the ground motion parameters and the peak displacement of structures, different earthquake parameters play role in peak displacement demand related to the ranges formed by the different periods and the strength ratio of a reinforced concrete systems. When considering the entire systems, the MIV earthquake parameter may be evaluated as more stable.

Nonlinear dynamic analysis is permitted to be used for structures without any restrictions. The important issue is the selection of the design earthquake to conduct the analyses since quite different response may be obtained using ground motion records at the same general area even resulting from the same earthquake. In Turkey, the destructive effects of the February 6 earthquakes are significant. Establishing the earthquake parameter associated with destruction and grading earthquake records to be used in calculations for various damage levels is of paramount importance. As a starting point, the relationship between four effective ground motion parameters containing different characteristics of the earthquake and damage has been attempted to be established for only the east-west direction records of the February 6<sup>th</sup> Elbistan earthquake in this study.

### PARAMETERS AND METHODS

#### Parameters

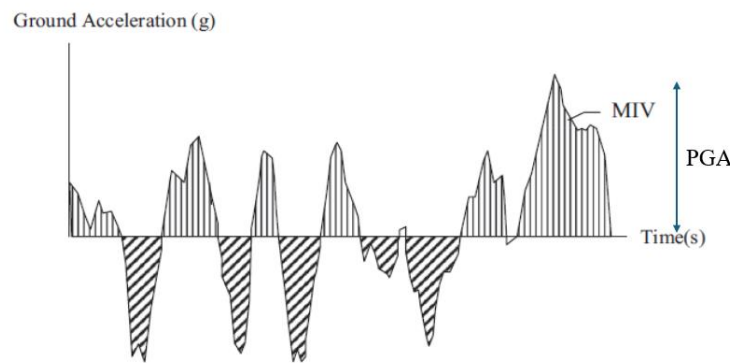
The parameters examined in relation to each other are earthquake characteristics and system damage, taken into account structural properties. Four selected parameters are related to the energy content, duration, or peak values of the ground motion records. These are PGA (Peak Ground Acceleration), MIV (Maximum Incremental Velocity), AI (Arias Intensity) and  $D_E$  (Effective Duration).

*PGA (Peak Ground Acceleration)*

This is the simplest parameter and has been used widely to identify earthquake ground motions. Although spectral response parameters are linearly related with PGA, some studies reported that it is not a totally reliable parameter (Cosenza and Manfredi, 2000), (Anderson and Bertero, 1987), (Sucuoğlu and Nurtuğ, 1995).

*MIV (Maximum Incremental Velocity)*

(Anderson and Bertero, 1987) indicated that the incremental velocity (IV) represented by the area under the acceleration time history makes ground motion particularly damaging (Figure 1). MIV is equal to the maximum IV (Kurama and Farrow, 2003), (Kurama et al., 1997), (Decanni and Mollaioli, 1998), (Naeim and Anderson, 1993). (Kurama and Farrow, 2003) stated that it may be a better parameter than PGA since MIV captures the impulsive characteristics of ground motion.



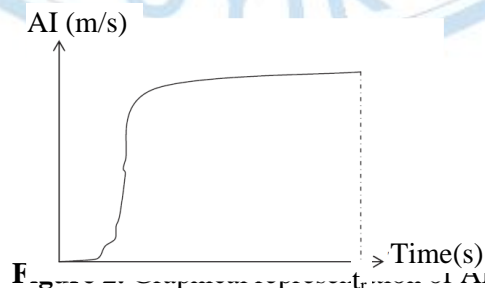
**Figure 1.** Graphical representation of MIV

*AI (Arias Intensity)*

The Arias Intensity introduced by (Arias, 1970) is defined as

$$AI = \frac{\pi}{2g} \int_0^{t_r} a_g^2(t) dt$$

where  $a_g(t)$  is the acceleration time-history,  $t_r$  is the total duration. (Travasarou, 2003) emphasized that AI is a strong predictor of the displacement response (Figure 2).

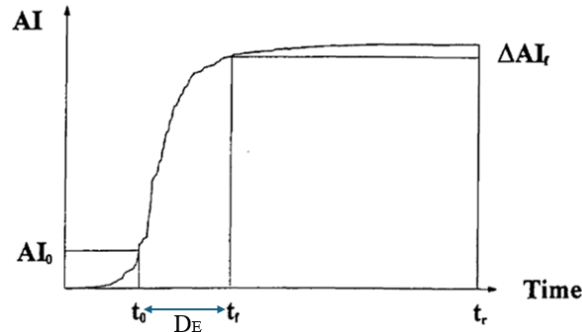


*$D_E$  (Effective Duration)*

The effective duration defined by (Bommer and Martinez-Pereira, 1999) is based on the Husid Plot, as shown in Figure 3. The proportion of total Arias intensity contained during time interval between  $t_0$  and  $t_r$  which mark the beginning and end of the strong phase was evaluated as an indicator for earthquake



records. While the beginning phase was considered as the time when the Husid plot reaches 0.01 m/s,  $AI_0$ , the end of the phase was defined as the time at which the remaining energy,  $\Delta AI_r$ , in the record is equal to 0.125 m/s.



**Figure 3.** Effective duration, adapted from Bommer and Martinez-Pereira (1999)

The structures are formed using different properties of the selected RC frames. The properties are obtained from the corresponding force–displacement relationships given in Figure 4. The  $M$  and  $W$  is mass and weight of the systems respectively.  $x_y$  represents frame yield displacement. The structural parameters that are taken as varied in the SDOF system with friction damper are given below:

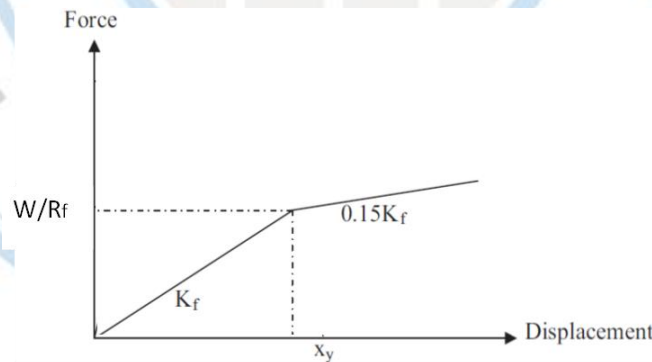
The Initial period of bare frame,  $T_f$ ,

$$T_f = 2\pi \sqrt{M/K_f}$$

The initial stiffness of the RC system  $K_f$ , is determined for the different values of  $T_f$  using this equation.

The strength ratio for the frame,  $R_f$ ,

$$R_f = \frac{W}{K_f x_y}$$



**Figure 4.** Force-displacement relationship for RC systems

The ranges of these parameters given in Table 1 constitute 27 systems.

**Table 1.** The values of structural parameters

$T_f$ (s)	0.1	0.2	0.3	0.4	0.5	0.6	0.7	0.8	0.9
$R_f$	6	8	10						

Q-hyst model proposed by (Saiidi and Sozen, 1979) is considered for nonlinear dynamic response of reinforced concrete in this study. (Kiris, 2020) also used this model for the evaluation of ground motion parameters and the four rules are given in (Sirin, 2009).

The linear relation between the earthquake parameters and the peak displacement demand can be expressed by the correlation coefficient ranging from -1.0 to +1.0. The closer correlation coefficient to -1 or +1, the more closely the two variables are related. If it is close to 0, it means there is no relationship between the pair of variables. If it is positive, when one variable gets larger, the other also gets larger. If negative, when one gets larger, the other gets smaller. The correlation coefficient between two variables, A and B is determined by

$$\text{Correlation coefficient } (A, B) = \frac{\sum(A - \bar{A})(B - \bar{B})}{\sqrt{\sum(A - \bar{A})^2 \sum(B - \bar{B})^2}}$$

where  $\bar{A}$  and  $\bar{B}$  are the median values of the variables.

## Methods

### *The Collection of the Data*

Fifteen earthquake records are taken from <https://tadas.afad.gov.tr/event-detail/17969>. East-west direction records of February 6th Elbistan Earthquake with PGA values exceeding 0.1g are considered (Table 2).

Table 2. The Earthquake Records

Code	Longitude	Latitude	PGA_EW (g)
4631	37,428	37,966	0,396
4611	37,284	37,747	0,142
4409	37,491	38,561	0,222
4612	36,482	38,024	0,534
4614	37,298	37,485	0,210
0213	37,930	37,797	0,129
4406	37,974	38,344	0,417
3802	36,504	38,478	0,225
NAR	37,157	37,392	0,113
0129	36,211	38,259	0,176
4410	37,679	38,867	0,130
4412	38,184	38,597	0,129
4405	37,940	38,811	0,161
0131	36,115	37,857	0,338
0141	35,528	37,563	0,208

For each record, the values of PGA, MIV, AI and D<sub>E</sub> is calculated. 405 nonlinear dynamic analyses are conducted using 27 RC systems and 15 earthquake records and the the peak displacement demands are calculated.

### *Statistical Analysis*

The correlation coefficients between the ground motion parameters and peak displacement resulted from nonlinear dynamic analyses are obtained. The examination of correlation coefficient values and their variations helps us identify the earthquake parameter that best serves as a damage indicator.

## RESULTS

The correlation coefficients between the ground motion parameters and peak displacement resulted from nonlinear dynamic analyses are calculated. For the strength ratio R<sub>f</sub>=6,8,10 and 9 different period of frame, the values of the correlation coefficients are shown in Figure 3.

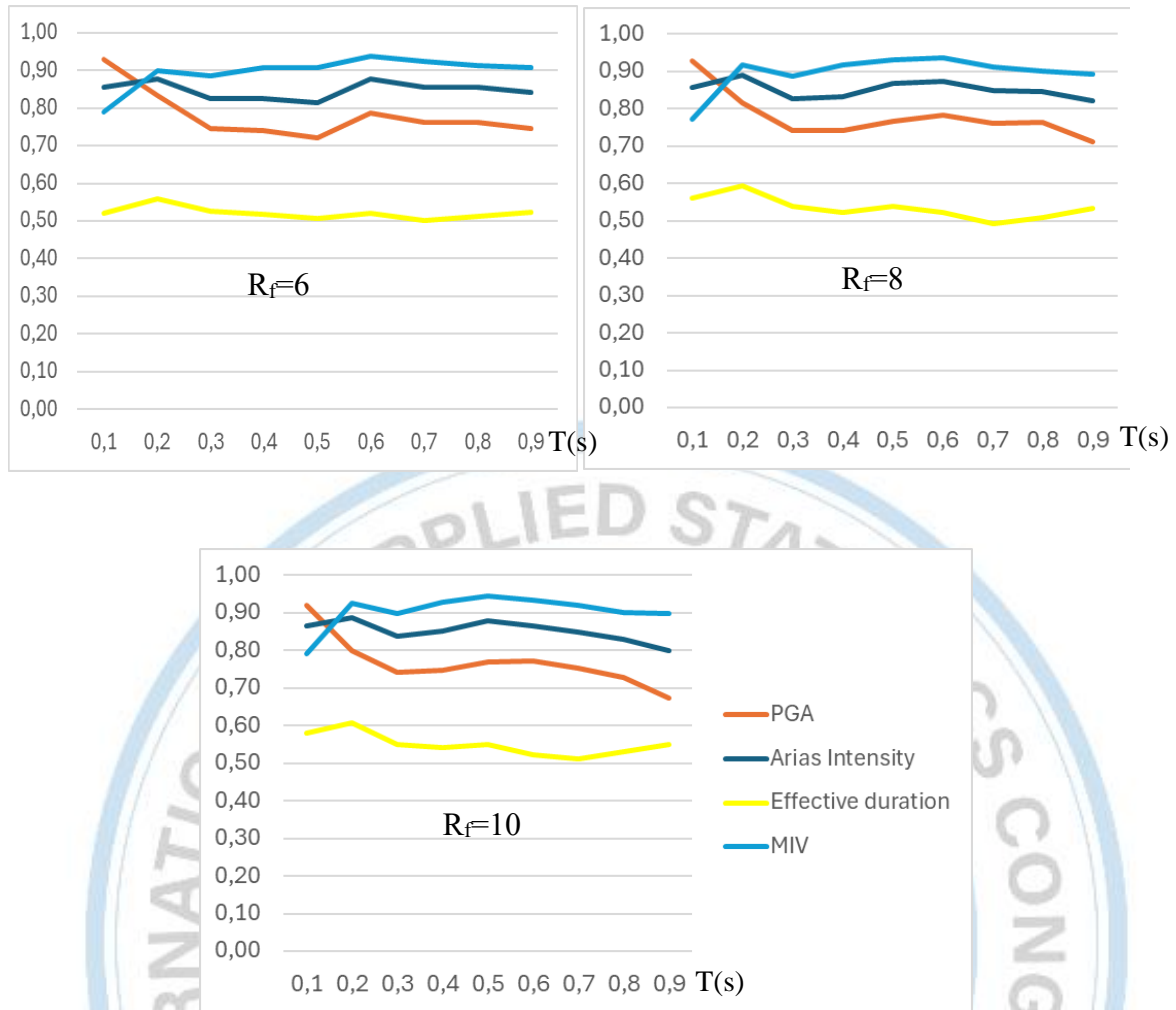


Figure 3. The correlation coefficients of PGA, Arias Intensity, Effective duration, and MIV

## DISCUSSION AND CONCLUSION

The following conclusions can be drawn from the observation of the correlation of ground motion parameters. The correlation of PGA with peak displacement demand is highly related to the values of  $T$ . The PGA shows the highest correlation for  $T=0.1s$ . In addition to having a high correlation, AI can be indicated as stable. The correlation of the effective duration is the lowest. When considering the entire systems, the correlation coefficients for the Maximum Incremental Velocity parameter (MIV) are closer to 1. Therefore, MIV is considered as the best damage indicator for this study.

There have been many studies about the correlation between ground motion parameter and damage indicator for structures. (Zhai and Xie, 2007) took into account the parameters based on the peak values of ground motion, duration and hysteretic energy to investigate the influence on the three typical period ranges of structures. They concluded that, the most unfavorable real seismic design ground motion parameter is related not only to the characteristics of ground motions, but also to both the structural dynamics characteristics and the structural damage mechanism. (Yang et al., 2009) and (Lestuzzi et al., 2004) and (Kiris, 2013) presented the correlation between different parameters and the maximum inelastic displacement and the energy responses. In this study, similar investigations were conducted for the east-west recordings of the Elbistan-centered earthquake, which occurred on February 6th, exhibiting notably new and destructive characteristics.

Expanding the scope of this study to include both east-west and north-south recordings of the Elbistan earthquake is crucial. Different recording locations and varying ground conditions provide us with the opportunity to evaluate the effects and propagation of the earthquake from different perspectives.



Furthermore, neglecting the influence of soil conditions can significantly impact the intensity and effects of the earthquake. The seismic properties of the soil can affect the propagation speed, intensity, and shape of earthquake waves. Therefore, considering the soil class also ensures that the results obtained are more accurate and comprehensive.

Examining the effects of the major earthquake that occurred 9 hours prior to the February 6th Elbistan Earthquake is also important. The previous earthquake may have had an impact on the ground conditions in the region, and understanding the effects of consecutive earthquakes can help us better assess earthquake risks.

Finally, it's noted that the Elbistan earthquake is of the Strike-slip fault type. To determine whether these results can be generalized for other fault types, additional studies for different fault types are warranted. Different fault types can have varying effects on the propagation, effects, and potential hazards of the earthquake, hence it's important to conduct separate evaluations for each fault type.

### References

- Anderson JC, Bertero V., 1987. Uncertainties in establishing design earthquakes, *Journal of Structural Engineering*, 113, 1709–24.
- Arias A., 1970. A measure of earthquake intensity. *Seismic Design for Nuclear Power Plants*. Hansen R, editor. MITP ress.
- Bommer, JJ and Martinez-Pereira, A, 1999. The effective duration of earthquake strong motion, *Journal of Earthquake Engineering*, 3(2), 127-172.
- Cosenza E, Manfredi G, 2000. Damage indices and damage measures, *Progress In Structural Engineering and Materials* (32), 2, 50–59.
- Decanni LD, Mollaioli F, 1998. Parameters to be considered in the establishment of the design earthquake based on energy concepts, in *Structural Engineering World Wide 1998*. In: Srivastava NK, editor. Elsevier.
- Kiris, SS, 2020. Investigation on Correlation of Earthquake Intensity Parameters with Seismic Response of Reinforced Concrete Structures. İstanbul: World Academy of Science, Engineering and Technology International Journal of Structural and Construction Engineering.
- Kiris, SS, Boduroglu MH, 2013. Earthquake parameters affecting the performance of an RC frame with friction damper, *Soil Dynamics and Earthquake Engineering*, 55, 148-160
- Kurama, Y, Sause, R, Pessiki, S and Lu, LW, 1997. Seismic design and response evaluation of unbonded post-tensioned precast concrete walls, *Research report EQ-97-01*. Bethlehem: Department of Civil and Environmental Engineering.
- Kurama YC, Farrow KT. 2003. Ground motion scaling methods for different site conditions and structure characteristics, *Earthquake Engineering and Structural Dynamics*, 32, 2425–2450.
- Lestuzzi P, Schwab P, Koller M, Lacave C., 2004. How to choose earthquake recordings for non-linear seismic analysis of structures. 13<sup>th</sup> world conference on earthquake engineering, August, 2004, Vancouver, Canada.
- Naeim F, Anderson JC, 1993. Classification and evaluation of earthquake records for design, CE 93-08, Department of Civil Engineering, University of Southern California. Los Angeles, CA.
- Sirin S, 2009. Influence of ground motion parameters on displacement demand and evaluation of analysis procedures for RC frames with friction damper, Ph.D. thesis, Istanbul Technical University, Institute of Science, İstanbul, Turkey.
- Sucuoğlu H, Nurtuğ A, 1995. Earthquake ground motion characteristics and seismic energy dissipation, *Earthquake Engineering and Structural Dynamics*, 24, 1195–213.
- Travasarou T, 2003. Optimal ground motion intensity measures for probabilistic assessment of seismic slope displacement, Ph.D. thesis, University of California, Berkeley, USA.
- Yang D, Pan J, Li G., 2009. Non-structure-specific intensity measure parameters and characteristic period of near-fault ground motions, *Earthquake Engineering and Structural Dynamics*, 38, 1257–1280.
- Zhai CH and Xie LL, 2007. A new approach of selecting real input ground motions for seismic design: The most unfavorable real seismic design ground motions, *Earthquake Engineering and Structural Dynamics*, 36, 1009-1027.

Classification of Provinces According to Judicial Statistics

Funda KARAMAN<sup>1</sup>

<sup>1</sup> Hacettepe University, Faculty of Science, Department of Actuarial Science, 06800, Ankara, Türkiye

\*Corresponding author e-mail: fundakaraman@hacettepe.edu.tr

**Abstract**

*The efficiency of the judiciary in disputes arising in reputation-based relational contracts is a factor that increases confidence in the market system. In other words, a country with a properly functioning judicial system is considered to increase its ability to attract foreign investment. According to Council of Europe European Commission for the Efficiency of Justice (CEPEJ) reports, the average duration of a lawsuit private law in Türkiye is longer than rest of member states. In this study, it is tried to determine the province groups showing the same structure with the help of judicial and regional variables for 81 provinces. For this reason, it is deemed appropriate to use the method called 'Cluster Analysis'. As a result of the analysis, the worst provinces according to the judgement statistics are also identified.*

**Keywords:** Cluster analysis, Court efficiency, Judiciary, Market system.

**INTRODUCTION**

An effective judiciary is crucial for the functioning of the market system. Courts play a key role in securing property rights and facilitating sustainable commercial activities in large-scale anonymous markets where reputation-based relational contracting loses effectiveness ( Johnson et al., 2002; Dove, 2017). In the last decade, in Türkiye, the legislature has enacted new laws or organized judicial reform packages aimed at ensuring judicial effectiveness, such as the mandatory mediation system, 8 judicial reform packages, reorganization of appeal periods etc. While these changes are expected to significantly contribute to judicial effectiveness, according to European statistics, Türkiye lags behind.

Regardless of the legal system, measures must be taken against the risks affecting the effectiveness of the legal system for the continuity of trust in the legal system. Although legal systems differ from country to country, ensuring judicial efficiency is extremely important for the sustainability of their development plans.

Scientific studies have been carried out with Data Envelopment Analysis (DEA) to detect territorial differences in many countries: Kittelsen&Førsund (1992) in Norway, Lewin et al. (1982) in the North Carolina, Tulkens (1993) in Belgium, Pedraja-Chaparro&Salina-Jime ´nez (1996) in Spain, Schneider (2005) in Germany, Yeung&Azevedo (2011) in Brazil, Gorman&Ruggiero (2009) in U.S.A., Nissi and Rapposelli (2010) in Italy, Buscaglia&Ulen (1997) in Latin America, Leclair (2002) in Canada, Hendley (1998) in Russia, Clark (1981) in England, Dimitrova-Grajzl et al. (2012) in Slovenia, Ramseyer (2012) in Japan, Beenstock&Haitovsky (2004) in Israel. However, there has been no academic analysis conducted on identify and measure Turkish regional judicial efficiency differences.

In this study, clustering analysis is employed to classify provinces based on judicial statistics and socio-economic indicators acknowledged to influence judgement.

**MATERIAL AND METHODS**

**Material**

The number of pending cases (which indicates the inefficiency degree of justice in relation to social expectations), the new cases filed during the year (which represents the justice demand) and the number cases finished during the year (the number of decisions) are obtained from the statistical annals published by Republic of Turkey Ministry of Justice General Directorate of Criminal Records and

Statistics, which is published at the end of May the following year.

The number of judges and auxiliary staff are gathered from activity reports published for each courthouse, based on Article 41 of Law No. 5018 and Directive No. 168 of the Ministry of Justice's Strategy Development Directorate for the year 2021.

The year 2021 is considered in the study because it is the most recent year for which separate judicial statistics for all provinces are provided, due to the successive earthquakes in southern Türkiye on February 6, 2023, which caused damage to Courthouse buildings.

Population and per capita gross domestic product (GDP) amounts in Turkish liras are considered based on statistics published by the Turkish Statistical Institute (TÜİK). Descriptive statistics for the variables are provided in Table 1.

**Table 1.** Descriptive statistics for the variables

Covariates	N	Mean	St. Dev.	Mode	Sum
(x1) The number of decisions	81	31,404.25	61,134.58	14,985	2,543,744
(x2) The number of new cases	81	31,304.49	59,965.76	15,234	2,535,664
(x3) The number of pending cases	81	21,971	54,114.57	8,864,00	1,779,651
(x4) The numbers of judges	81	51.35	84.81	26	4,159
(x5) The number of auxiliary staff	81	191.33	375.98	87	15,498
(x6) Population	81	1,045,435	1,902,489.10	546,589	84,680,273
(x7) GDP	81	64,762.46	25,054	58,762.66	5,245,759.5

The correlation matrix for the variables is presented in Table 2.

**Table 2.** Correlation matrix for the variables

	x1	x2	x3	x4	x5	x6	x7
x1	1						
x2	0.993	1					
x3	0.990	0.987	1				
x4	0.986	0.988	0.971	1			
x5	0.998	0.996	0.991	0.986	1		
x6	0.509	0.988	0.99	0.973	0.988	1	
x7	0.991	0.516	0.482	0.498	0.514	0.474	1

## Methods

Cluster analysis is one of the most commonly used multivariate statistical methods because it does not require assumptions of normality, linearity, and homogeneity of variance that are needed in other methods.

Cluster analysis categorizes units (individuals, objects, etc.) that are very similar to each other into the same cluster according to pre-defined selection criteria. As a result of the analysis, units within a cluster resemble each other, while units from different clusters do not. Therefore, clusters are internally homogeneous but heterogeneous across clusters. A successful clustering process will show that units within the same cluster are closely related in multidimensional space, whereas units in different clusters are noticeably distant from each other. In this method, clustering involves using distance measures that vary according to the units of measurement.

There are many predefined distance measures and methods available for cluster analysis. In this study, Euclidean distance,

$$d_2(x_i, x_j) = \sum_{k=1}^p \left[ |x_{ik} - x_{jk}|^2 \right]^{1/2}$$

and the K-means clustering technique

$$W_n = \frac{1}{n} \sum_{i=1}^n \min_{1 \leq j \leq k} |x_i - a_{jn}|^2$$



V. INTERNATIONAL APPLIED STATISTICS CONGRESS (UYİK - 2024)  
İstanbul / Türkiye, May 21-23, 2024

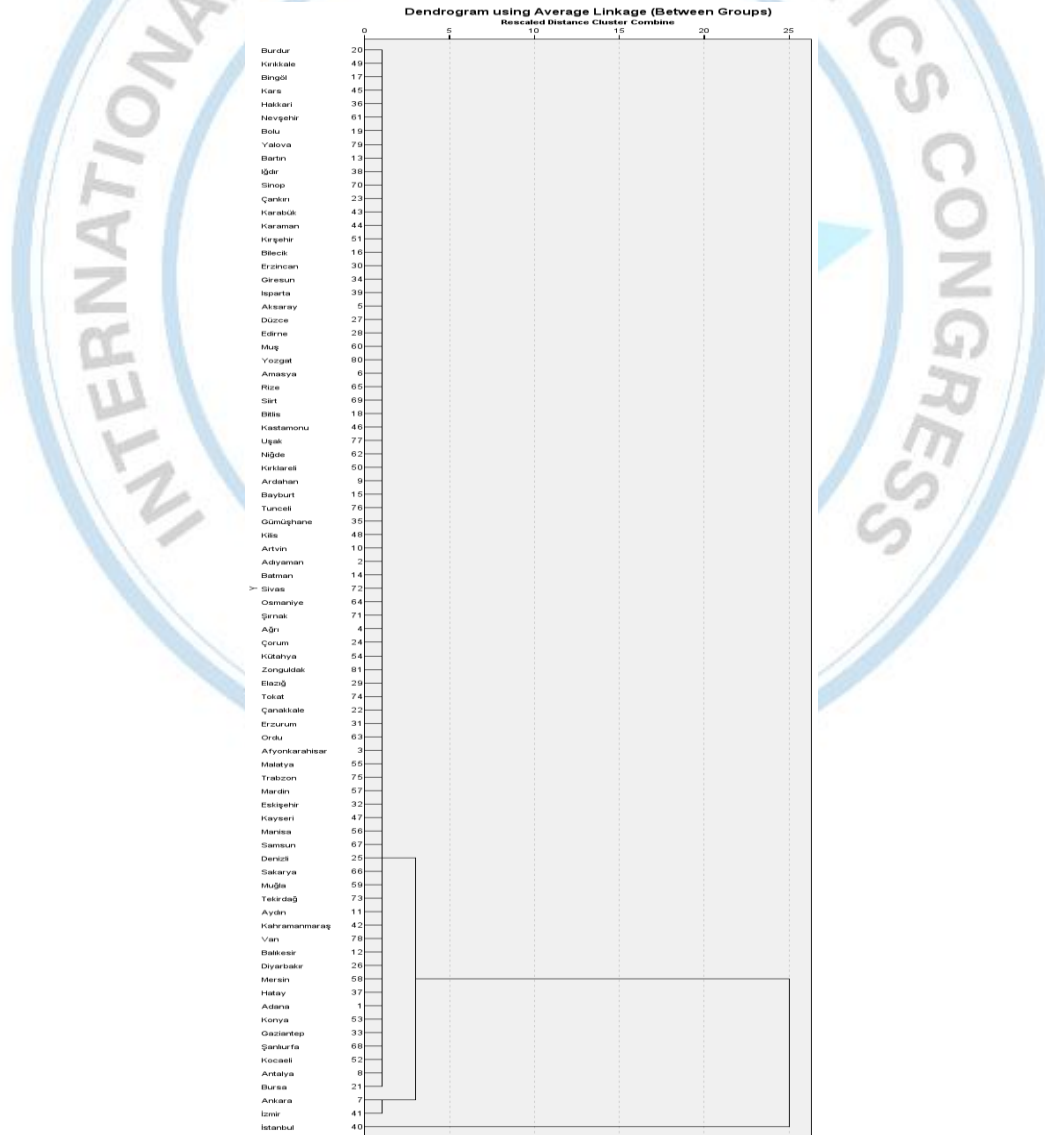
are utilized. To assess the statistical reliability of the clusters, an ANOVA table is constructed (Tatlıdil,2002). SPSS is used for the analysis.

**RESULTS**

According to the ANOVA analysis, the number of clusters obtained is 6, and presented in Table 3. Additionally, the dendrogram plot is provided in Figure 1.

**Table 3.** Anova results

Covariates	Cluster		Error		F	Sig.
	Mean Square	df	Mean Square	df		
x1	5919416718	5	90154112	75	656.59	<,001
x2	5216014359	5	81175037	75	642.56	<,001
x3	4690601861	5	35589949	75	1317.96	<,001
x4	111359	5	343	75	324.14	<,001
x5	2224886	5	4348	75	511.69	<,001
x6	5788053114	5	5031973247	75	1150.26	<,001
x7	2465361491	5	513561961	75	4.80	<,001



**Figure 1.** Dendrogram plot

V. INTERNATIONAL APPLIED STATISTICS CONGRESS (UYİK - 2024)  
İstanbul / Türkiye, May 21-23, 2024

The provinces for 6 clusters in the cluster analysis are presented in Table 4 and Figure 2.

Table 4. The distribution of provinces is according to cluster analysis

Provinces	Cluster Number	Provinces	Cluster Number	Provinces	Cluster Number
Adana	1	Kahramanmaraş	3	Edirne	6
Adıyaman	6	Karabük	6	Elazığ	6
Afyonkarahisar	3	Karaman	6	Erzincan	6
Ağrı	6	Kars	6	Erzurum	3
Aksaray	6	Kastamonu	6	Eskişehir	3
Amasya	6	Kayseri	3	Gaziantep	1
Ankara	5	Kilis	6	Giresun	6
Antalya	1	Kırıkkale	6	Gümüşhane	6
Ardahan	6	Kırklareli	6	Hakkari	6
Artvin	6	Kırklareli	6	Hatay	1
Aydın	3	Kırşehir	6	Iğdır	6
Balıkesir	3	Kocaeli	1	Isparta	6
Bartın	6	Konya	1	İstanbul	4
Batman	6	Kütahya	6	İzmir	2
Bayburt	6	Malatya	3	Siirt	6
Bilecik	6	Manisa	3	Sinop	6
Bingöl	6	Mardin	3	Şırnak	6
Bitlis	6	Mersin	1	Şivas	6
Bolu	6	Muğla	3	Tekirdağ	3
Burdur	6	Muş	6	Tokat	6
Bursa	1	Nevşehir	6	Trabzon	3
Çanakkale	6	Niğde	6	Tunceli	6
Çankırı	6	Ordu	3	Uşak	6
Çorum	6	Osmaniye	6	Van	3
Denizli	3	Rize	6	Yalova	6
Diyarbakır	1	Sakarya	3	Yozgat	6
Düzce	6	Samsun	3	Zonguldak	6
		Şanlıurfa	1		



Figure 2. The distribution of provinces is according to cluster analysis on Turkish map

Upon examining the results of the cluster analysis, it is found that evaluating judicial statistics based on geographical regions is not suitable. It is also observed that the three major cities İstanbul, İzmir, and Ankara are placed in different and individual clusters. The structure of these provinces is characteristically different from each other.

As a result, it is evident that to achieve judicial statistics that are deemed optimal according to European standards, it is necessary to extract the socio-economic profile of provinces and to legislate accordingly based on this profile.

## DISCUSSION AND CONCLUSION

Upon examining the results of the cluster analysis, it is found that evaluating judicial statistics based on geographical regions is not suitable. It is also observed that the three major cities İstanbul, İzmir, and Ankara are placed in different and individual clusters. The structure of these provinces is characteristically different from each other.

As a result, it is evident that to achieve judicial statistics that are deemed optimal according to European standards, it is necessary to extract the socio-economic profile of provinces and to legislate accordingly based on this profile.

## References

- Johnson, S., McMillan, J., & Woodruff, C. (2002). Property Rights and Finance. *The American Economic Review*, 92(5), 1335–1356. <http://www.jstor.org/stable/3083253>.
- Dove, J. A., (2017). Property Rights and Finance. *Public Budgeting & Finance*, 37(3), 24-46, <https://onlinelibrary.wiley.com/doi/full/10.1111/pbaf.12153>.
- Kittelsen, S.A. and Førsum, F.R. (1992), Efficiency analysis of Norwegian district courts, *The Journal of Productivity Analysis*, vol.3, no.3, 277–306.
- Lewin, A.Y., Morey, R.C., Cook, T.J. (1982), Evaluating the administrative efficiency of Courts, *Omega - International Journal of Management Science*, vol.10, no.4, 401-411.
- Tulkens, H. (2002), On FDH efficiency analysis: Some methodological issues and applications to retail banking, courts, and urban transit, *Journal of Productivity Analysis*, vol.4, 183-210.
- Pedraja-Chaparro, F. and Salina-Jime'nez, J. (1996), An assessment of the efficiency of Spanish courts using DEA, *Applied Economics*, vol.28, no.11, 1391-1403.
- Schneider, M.R. (2005), Judicial career incentives and court performance: an empirical study of the German Labour Courts of Appeal, *European Journal of Law and Economics*, vol.20, no.2, 127-144.
- Yeung, L. L. and Azevedo, P. F. (2011), Measuring efficiency of Brazilian courts with data envelopment analysis (DEA), *IMA Journal of Management Mathematics*, vol.22, no.4, 343-356.
- Gorman, M.F. and Ruggiero, J. (2009), Evaluating US judicial district prosecutor performance using DEA: Are disadvantaged counties more inefficient?, *European Journal of Law and Economics*, vol.27, no.3, 275–283.
- Nissi, E. and Rapposelli, A. (2010), A data envelopment analysis of Italian courts efficiency, *Statistica Applicata - Italian Journal of Applied Statistics* vol.22, no.2, 199-210.
- Buscaglia, E. and Ulen T. (1997), A quantitative assessment of the efficiency of the judicial sector in Latin America, *International Review of Law and Economics*, vol.17, no.2, 275-291.
- Leclair, J. (2002), The Supreme Court of Canada's Understanding of Federalism: Efficiency at the Expense of Diversity, *Queen's L.J.*, vol.411.
- Hendley, K. (1998), Growing Pains: Balancing Justice and Efficiency in the Russian Economic Courts, *Temp. Int'l and Comp. L.J.*, vol.12, p.301.
- Clark, D.S. (1981), Adjudication to Administration: A statistical Analysis of Federal District Courts in the Twentieth Century, *S. Cal. L. Rev.*, vol.55, p.65.
- Dimitrova-Grajzl, V., Grajzl, P., Sustersic, J. and Zajc, K. (2012), Court output, judicial staffing, and the demand for court services: Evidence from Slovenian courts of first instance, *International Review of Law and Economics*, vol.32, no.1, 19–29.
- Ramseyer, J.M. (2012), Talent matters: Judicial productivity and speed in Japan, *International Review of Law and Economics*, vol.32, no.1, 38–48.
- Beenstock, M. and Haitovsky, Y. (2004), Does the appointment of judges increase the output of the judiciary?, *International Review of Law and Economics*, vol.24, no.3, 351–369.



**V. INTERNATIONAL APPLIED STATISTICS CONGRESS (UYIK - 2024)**  
**İstanbul / Türkiye, May 21-23, 2024**

---

Tatlıdil, H. (2002). Uygulamalı çok değişkenli istatistiksel analiz. Ankara: Ziraat Matbaacılık A.Ş.,329-332.

Turkish General Directorate of Criminal Records and Statistics (Date accessed : 01.01.2024), <https://adlisicil.adalet.gov.tr/Home/SayfaDetay/adli-istatistik-calismalari>

Turkish Statistical Institute (Date accessed : 01.01.2024), <https://data.tuik.gov.tr/Bulten/Index?p=Donemsel-Gayrisafi-Yurt-Ici-Hasila-IV.-Ceyrek:-Ekim-Aralik-ve-Yillik,-2023-53756>

Turkish Statistical Institute (Date accessed : 01.01.2024), <https://data.tuik.gov.tr/Kategori/GetKategori?p=Nufus-ve-Demografi-109>

SPSS, <https://www.ibm.com/products/spss-statistics>

**Conflict of Interest**

There is no conflict of interest of the authors.



Kübra Buzlu<sup>1\*</sup>, Yaren Can<sup>1</sup>, Hüseyin Taşkın<sup>1</sup>, Avşe Berna Altinel<sup>1\*</sup>, Abdulsamet Aktaş<sup>1</sup>

<sup>1</sup>Marmara University, Faculty of Technology, Department of Computer Engineering, 34854, Istanbul, Türkiye

\*Corresponding author e-mail: [berna.altinel@marmara.com.tr](mailto:berna.altinel@marmara.com.tr)

### Abstract

*Analysis of fundus images is crucial for preventing blindness by enabling early diagnosis of eye diseases. Additionally, the need for specialists can be reduced through the analysis of fundus images, and the workload of experts can be eased. Motivated by these important goals, in this study, we perform classification with deep learning models on the Ocular Disease Recognition Dataset (ODIR), which consists of 6392 ocular fundus images with eight different classes. The dataset includes images belonging to age-related macular degeneration, cataract, diabetes, glaucoma, hypertension, normal, pathological myopia, and other diseases. In order to overcome the problems caused by the unbalanced distribution between the classes in the dataset, images of classes with few samples were augmented with various data augmentation methods. Furthermore, black areas surrounding the fundus images were cropped, and the data were resized to fit the deep learning model to be used. Two different versions of the data were created by applying CLAHE and Gaussian blur. In this study, the dataset was classified using InceptionV3, Xception, DenseNet121, and MobileNetV2 architectures. Experimental results show that the Xception architecture is more successful than other models, with an F1 score of 89% on the augmented dataset.*

**Keywords:** Deep Learning, Eye Diseases, Fundus Images Analysis, Medical Image Classification, Ocular Disease Recognition Dataset (ODIR).

### INTRODUCTION

Visual impairments and eye disorders are significant health issues that affect millions of people worldwide. According to the 2019 report from the World Health Organization, at least 2.2 billion people globally suffer from various visual impairments, and at least 1 billion of these conditions are preventable or treatable (World Health Organization, 2019).

Many eye disorders can be prevented with early diagnosis and effective treatment. However, due to the lack of medical resources in some countries, early diagnosis is not always possible, leading to vision loss in patients. This issue is particularly prevalent in low- and middle-income countries. In terms of eye care, significant challenges include such as inequalities in the scope and quality of prevention, treatment, and rehabilitation services, a shortage of trained eye care service providers, and inadequate integration of these services into existing health systems. Therefore, the development of automated diagnosis systems is of great importance. Artificial intelligence, especially deep learning techniques, plays a crucial role in the development of these systems.

The presence of eye diseases can be recognized by observing abnormalities near retinal regions such as the optic nerve and blood vessels (Bhati et al., 2023). Thus, fundus data is used to classify eye diseases. Fundus images are photographs of the interior surface of the eye, including the retina, optic disc, macula, and posterior pole. These images are critical for diagnosing various eye disorders such as diabetic retinopathy, glaucoma, and macular degeneration. Multi-label classification and multi-class classification approaches have been used to identify multiple eye diseases from a single image. Extensive research has been conducted using convolutional neural networks (CNNs) to detect diseases from fundus images.

One significant dataset in this field is the Ocular Disease Intelligent Recognition (ODIR) database. This dataset was introduced by Peking University for the ‘Peking University International Competition

on ODIR (ODIR-2019)' held in 2019, aimed at developing AI for image-based diagnosis using a dataset of eye fundus. This database includes data from 5,000 patients, comprising color fundus photographs and diagnostic keywords. The dataset represents real patient information collected from various hospitals and medical centers in China by Shanggong Medical Technology Co., Ltd. (Shanggong Medical Technology Co., Ltd., 2020). The images are categorized into eight classes. ODIR includes both single-label multi-class classification and multi-label classification studies. Due to its comprehensive and diverse collection of fundus images, the ODIR dataset is crucial for the development and evaluation of automatic diagnostic systems.

In 2023, Lu et al. developed a multi-label classification model using a CNN enhanced with a squeeze-and-excitation (SE) module to effectively extract information from color fundus images (Lu et al., 2023). This model performs eight different classifications of eye diseases using the ODIR database. To improve the model's success, preprocessing steps such as removing low-quality images, cropping large black background areas, resizing, and applying Contrast Limited Adaptive Histogram Equalization (CLAHE) for illumination correction were applied. In the study, oversampling techniques were used to address data imbalance by augmenting the samples of underrepresented classes. This technique allows the model to better learn these classes by increasing the number of samples for classes with fewer examples.

The SE Module enables the CNN to learn and emphasize importance feature maps. By modeling inter-channel dependencies, it selects important features and suppresses less important ones. This allows the model to learn more effectively and avoid unnecessary computations. The study by Lu et al. achieved better performance with fewer training parameters compared to the EfficientNet-based model developed by (Wang et al., 2020) and the graph convolutional networks (GCN) and self-supervised learning model developed by (Lin et al., 2021), achieving 94.27% accuracy, 85.80% AUC, and 86.08% F1 score (Lu et al., 2023; Wang et al., 2020; Lin et al., 2021). These studies demonstrate the effectiveness of CNN-based models in classifying fundus diseases and show that these models can be used in clinical screening applications.

In the same year, Mohamed et al. developed a deep learning-based system for multi-class eye disease classification using the ODIR-5K database (Mohamed et al., 2023). This system, which classifies diabetic retinopathy, glaucoma, and cataract diseases, achieved an accuracy of 92%. In the preprocessing, images of different resolutions were cropped and resized to 256x256 pixels through binary segmentation. The VGG16 architecture achieved the highest F1 score of 99.09% for diabetic retinopathy class. Among the architectures used in this study, the ResNet50 architecture achieved the highest overall accuracy of 92.18%. The VGG16 model had an accuracy of 86.26%. The MobileNetV2 model achieved an accuracy of 91.79%.

Also in 2023, Bhati et al. developed the DKCNet, a convolutional neural network for multi-label classification, tested on the ODIR-5K dataset (Bhati et al., 2023). This model, which includes an attention block followed by a Squeezing and Excitation (SE) block, enhances feature maps by improving inter-channel dependencies. Data preprocessing includes addressing class imbalances through random sub-sampling of over-represented classes and artificial oversampling of under-represented classes. Various image pre-processing techniques, such as standardization of image dimensions and light correction, were applied before the images were fed into the model. Using the DKCNet model, combined with the InceptionResNet backbone network and utilizing the oversampled dataset, achieved the highest performance metrics in the study. The model attained an F1 score of 94.28%, an AUC score of 96.08%, and a kappa score of 81%. It shows superior performance compared to other models.

A literature review revealed no study that compared the performance measures such as accuracy, precision, sensitivity, loss, and F1 score of models including InceptionV3, Xception, DenseNet121, and MobileNetV2 together. Therefore, our proposed deep learning-based model is evaluated by comparing it with these models based on the mentioned performance metrics.



The remainder of the paper is organized as follows: In the ‘*Material*’ subsection of ‘*Material and Methods*’, we detail the ODIR database and describe the data augmentation and filtering processes utilized. In the ‘*Methods*’ subsection, we discuss the implementation and technical specifications of the deep learning models employed, including DenseNet121, InceptionV3, MobileNetV2, and Xception. In the ‘*Results and Discussion*’ section, we present the findings obtained from applying these models to the ODIR dataset, including various configurations and their corresponding F1 scores. In the ‘*Conclusion and Future Remarks*’ section, we evaluate the performance and implications of our findings. We discuss the successes and limitations encountered in the classification of ophthalmic diseases using deep learning technologies and outline future research directions.

## MATERIAL AND METHODS

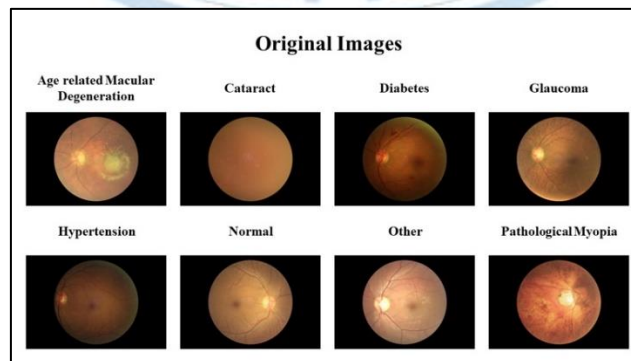
### Material

ODIR is an ophthalmic database containing color fundus photographs of the left and right eyes of 5,000 patients, their age, and diagnostic keywords from doctors. This dataset was obtained from real patients from different hospitals and medical centers in China. It was created by Shangong Medical Technology Co. and published on Kaggle (Shangong Medical Technology Co., Ltd., 2020). The images, captured using various cameras such as Canon, Zeiss, and Kowa, exhibit different resolutions and have been meticulously labeled by experts. Fundus images are divided into eight classes: age-related macular degeneration (AMD), cataract, diabetes, hypertension, normal, pathological myopia, and other diseases or abnormalities. The 'others' class includes eye diseases that do not indicate a specific disease or do not fit into other classes. This class encompasses fundus images containing anomalies such as drusen, lens dust, optic disc invisibility, maculopathy, vitreous degeneration, or abnormalities of the optic nerve fibers, such as myelinated nerve fibers. The number of samples for each disease in ODIR is given in Table 1 below.

**Table 13.** Distribution of classes in the dataset

Class	Count
Age related Macular Degeneration	266
Cataract	293
Diabetes	1608
Glaucoma	284
Hypertension	128
Normal	2873
Others	708
Pathological Myopia	232

An example of a raw fundus image for each class is shown in Figure 1.



**Figure 18.** Sample fundus image of each class

## Methods

### Data Augmentation and Filtering Processes

Data augmentation techniques were applied to address the class imbalances in the dataset. The images were augmented through rotations and horizontal and vertical flips. These augmentations were applied only to the training data, keeping the test data unchanged. Three different versions of data augmentation were created:

**Version 1:** The training data for all classes was increased to 3,500.

**Version 2:** The training data for all classes was increased to 10,000.

**Version 3:** The training data for all classes was augmented based on given weights, with class-specific training data ranging from 1,000 to 2,000.

Sample applications of the duplication process are shown in Figure 2.



Figure 19. Duplicated fundus image examples

### Filtering Processes

For a more effective analysis, two types of filters were applied to the fundus images. Initially, with both filters, the fundus images were centrally cropped and black borders were removed. After this stage, different processes were applied to each filter. The first filter divided the image into red (r), green (g), and blue (b) channels, applying CLAHE (Contrast Limited Adaptive Histogram Equalization) to each channel. Then, the three channels were combined again. This provided a more pronounced and balanced improvement in the details of the image. The second filter converted the image to grayscale and applied edge enhancement using Gaussian blur. Finally, both filters resized the images to 224x224 pixels. In this way, the images were standardized and used more efficiently in training. Sample applications of Filter 1 are given in Figure 3a, and sample applications of Filter 2 are given in Figure 3b.

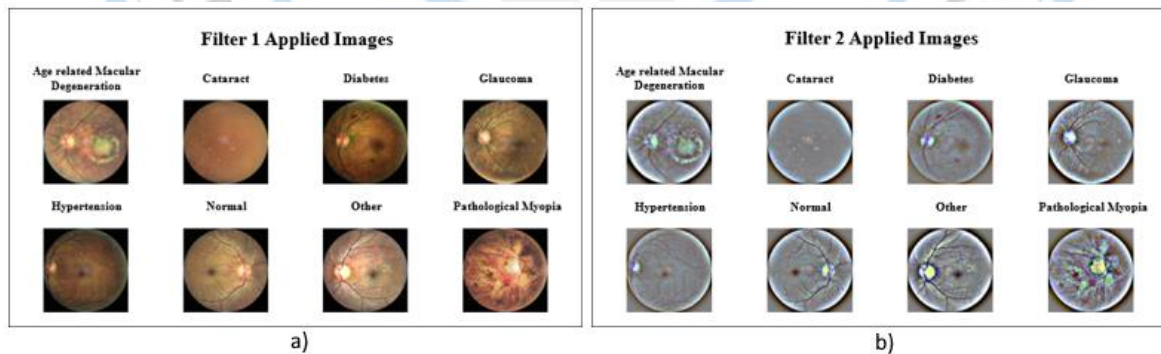


Figure 20. Fundus images a) with Filter 1 b) with Filter 2

The results were comprehensively compared using four distinct deep learning architectures to classify the newly processed ODIR dataset, obtained through the pre-processing steps described earlier. The deep learning architectures employed in this study are:

**InceptionV3:** InceptionV3 is a CNN architecture that holds an important place in the fields of deep learning and image classification. Developed by Google, this model is designed particularly to achieve effective results on large and complex datasets. InceptionV3 has a complex architecture comprising convolutional layers of various depths and widths. It incorporates Inception blocks based on parallel

convolution operations that can capture information at different scales and levels. This allows the network to learn different features simultaneously and represent them more effectively. It is preferred for many tasks, such as image classification, object detection, and image segmentation, where it delivers effective results (Szegedy et al., 2016).

**Xception:** Xception represents the concept of extreme inception. This deep learning architecture enhances and expands upon the original Inception architecture. This deep learning architecture utilizes depth-wise separable convolutions instead of the detailed Inception modules, thereby increasing parameter and computational efficiency to achieve more effective results. The fundamental principle of the Inception architecture is to employ parallel convolutional operations to capture information at different scales. However, a notable disadvantage of this approach is the increase in the number of parameters and computational complexity as the network deepens. Xception addresses this issue by employing 'depth-wise separable convolutions,' which reduce computational costs by performing separate convolutions for each channel's feature map. Subsequently, 1x1 convolutions are used to enhance inter-channel information interaction. As a result, Xception facilitates more efficient learning with fewer parameters. This architecture is widely used in various fields, including classification and feature extraction (Chollet, 2017).

**DenseNet121:** DenseNet121 architecture is a widely used CNN model in the field of deep learning. DenseNet is known for its structure called dense blocks, which are used to provide more effective information flow when training deep networks. Unlike traditional CNN architectures, DenseNet is characterized by densely connected blocks. These dense blocks have a structure in which each layer in the network is directly connected to the previous layers. This improves information flow and reduces the vanishing gradient problem. These connections also allow the network to be deeper while reducing the number of parameters which makes training more efficient. The "121" denotes the total number of layers in the network. It is commonly preferred for image classification problems (Huang et al., 2017).

**MobileNetV2:** MobileNetV2 is specifically designed to address the challenges posed by mobile devices and resource-constrained environments. This model employs innovative techniques like inverted residuals and linear expansion to achieve a deep network structure with fewer parameters. By doing so, MobileNetV2 strikes a balance between model complexity and computational efficiency, making it well-suited for deployment on devices with limited computational resources. The inverted residuals concept involves the utilization of lightweight bottleneck layers characterized by a narrow bottleneck followed by a linear expansion. This approach allows MobileNetV2 to efficiently capture and represent complex features within the network while minimizing the computational cost. One of the keys to the advantages of MobileNetV2 is its ability to maintain robustness and accuracy despite its lightweight nature. MobileNetV2 is widely used across various applications, including image classification, object detection, and semantic segmentation (Sandler et al., 2018).

The workflow of our proposed system, detailing the data augmentation techniques, filtering processes, and application of various deep learning models used to classify the ocular disease categories, is illustrated in Figure 4.

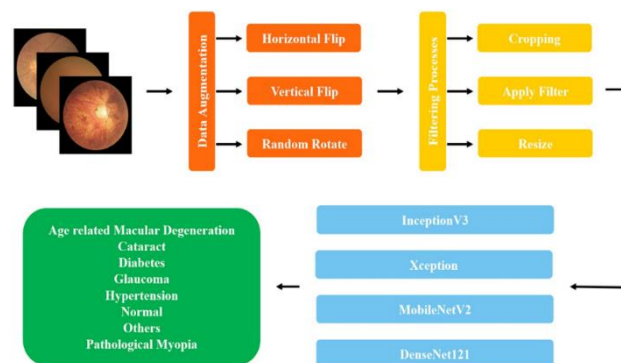


Figure 21. Workflow of the proposed system



## RESULTS AND DISCUSSION

During the study, four different deep learning architectures, DenseNet121, InceptionV3, MobileNetV2, and Xception, were utilized. For each architecture, Filter 1 was applied to the ODIR dataset, and the F1 Score results for the augmented versions of each class with 3.500 examples in the training set are presented in Table 2. In the tables, the abbreviations are as follows: Cataract is denoted as CAT, Diabetes as DR, Glaucoma as GLC, Hypertension as HYP, Normal as NML, Others as OTH, and Pathological Myopia as PM.

**Table 14.** F1 Scores for dataset with Filter 1 and class augmented to 3.500 Instances

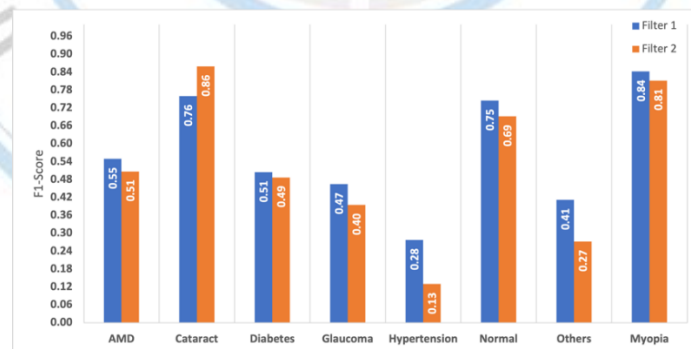
	AMD	CAT	DR	GLC	HYP	NML	OTH	PM
DenseNet121	0.56	0.84	0.45	0.40	0.18	0.71	0.34	0.80
InceptionV3	0.54	0.87	0.49	0.35	0.10	0.65	0.36	0.79
MobileNetV2	0.55	0.84	0.47	0.40	0.08	0.69	0.11	0.83
Xception	0.38	0.89	0.54	0.43	0.16	0.72	0.28	0.83

The results in Table 2 show that the Xception model outperformed the other models, achieving the highest-class result with an F1 score of 0.89 for the Cataract class. Similarly, for each deep learning model, F1 Score results for the training set of each class, augmented to 3.500 examples, with Filter 2 applied to the ODIR dataset are presented in the following Table 3.

**Table 15.** F1 Scores for dataset with Filter 2 and class augmented to 3.500 Instances

	AMD	CAT	DR	GLC	HYP	NML	OTH	PM
DenseNet121	0.62	0.74	0.54	0.41	0.13	0.75	0.41	0.84
InceptionV3	0.51	0.76	0.48	0.52	0.28	0.75	0.40	0.87
MobileNetV2	0.57	0.75	0.44	0.49	0.36	0.73	0.39	0.83
Xception	0.50	0.79	0.56	0.44	0.34	0.75	0.45	0.83

According to the results in Table 3, the more successful model than the others was InceptionV3, and it achieved an F1 score of 0.87 for the Myopia class. Figure 5 was created to observe the impact of two different filters applied to fundus images on model performance. In this context, each dataset was augmented to have 3.500 training samples per class, with different filters applied to each. The created graph represents the average F1 score results of four models trained on the datasets with the applied filters.



**Figure 22.** The impact of two different filters on model performance for each ocular disease class

According to Figure 5, Filter 2 achieved better results than Filter 1 for all classes except Cataract. Based on this, it can be concluded that Filter 2 is more suitable for detecting eye diseases compared to Filter 1. Three additional datasets were created to observe the effects of increasing or decreasing the number of examples. First, the ODIR dataset was expanded to around 2.000 for each class to approximate the Normal class size and created by applying Filter 1. The F1 Score results for this dataset are presented in Table 4.

**Table 16.** F1 Scores for dataset with Filter 1 applied and each class augmented to around 2000 instances

	AMD	CAT	DR	GLC	HYP	NML	OTH	PM
DenseNet121	0.61	0.84	0.49	0.50	0.37	0.71	0.32	0.80
InceptionV3	0.48	0.84	0.49	0.46	0.15	0.70	0.40	0.81
MobileNetV2	0.63	0.87	0.33	0.44	0.02	0.69	0.17	0.84
Xception	0.64	0.87	0.64	0.48	0.25	0.73	0.45	0.83

In the results above, out of the four models, two have shown higher success. The Xception and MobileNetV2 models have achieved better results than the others; however, when considering the overall average of the classes, it is observed that the Xception model is more successful. Subsequently, the models were retrained by applying Filter 2 to the dataset, the results of which were previously obtained by applying Filter 1, as shown in the Table 4. The results of the relevant dataset are shown in Table 5 below.

**Table 17.** F1 Scores for dataset with Filter 2 applied and each class augmented to around 2000 instances

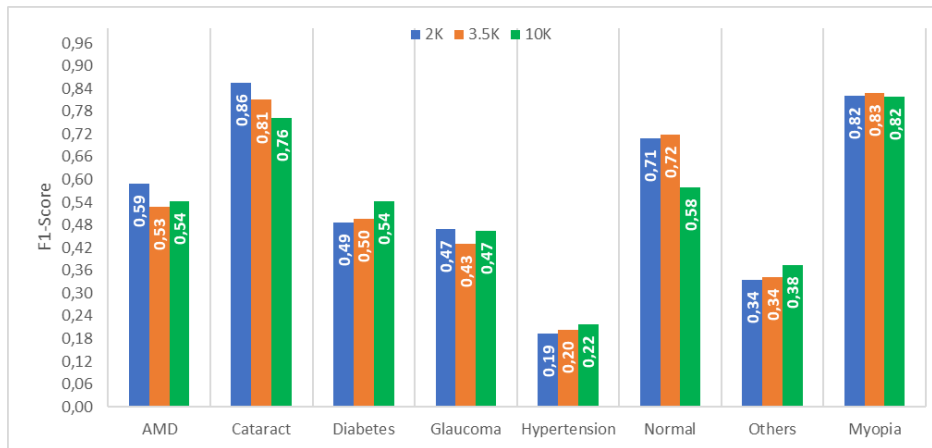
	AMD	CAT	DR	GLC	HYP	NML	OTH	PM
DenseNet121	0,54	0,74	0,50	0,54	0,16	0,75	0,41	0,85
InceptionV3	0,53	0,75	0,44	0,44	0,17	0,74	0,41	0,80
MobileNetV2	0,53	0,77	0,49	0,55	0,22	0,76	0,45	0,88
Xception	0,60	0,78	0,55	0,51	0,23	0,76	0,45	0,87

A comparison of the results in Tables 4 and 5 indicates that the Cataract class performs significantly better under Filter 1. This suggests that Filter 2 generally yields more successful outcomes for other classes, except for the AMD and Cataract classes. Notably, Filter 2 provides a substantial improvement for the Myopia class. Further analysis comparing the results in Tables 3 and 5 reveals the impact of varying dataset sizes on model performance, despite the application of the same filter. According to the results in Table 4, overall improvements are observed in the Myopia, Others, and Glaucoma classes. Conversely, a slight decline is noted in the Diabetes and Hypertension classes, while no significant changes are evident for the AMD and Cataract classes. Additionally, model-specific performance highlights the increased success of the MobileNetV2 model, achieving an accuracy of 0.88 for the Myopia class, the highest recorded for this class. Despite this, the Xception model appears to be more balanced overall. The last dataset, where each class was augmented to 10.000 examples and Filter 2 was applied, is presented in Table 6.

**Table 18.** F1 Scores for dataset with Filter 2 applied and each class augmented to 10.000 instances

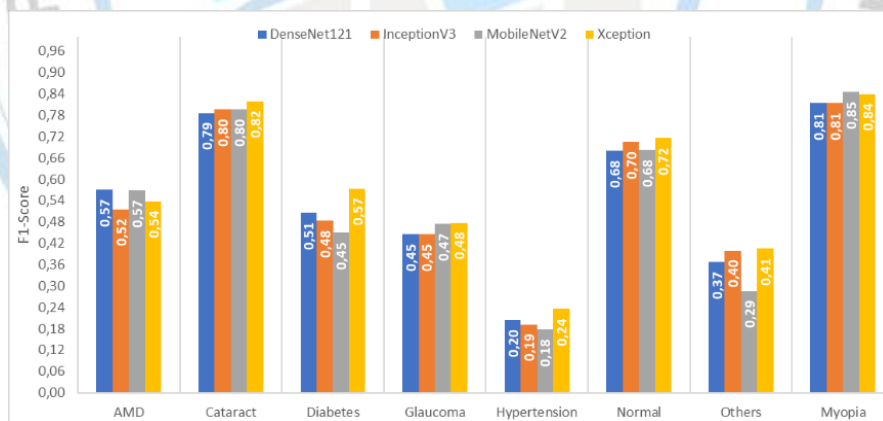
	AMD	CAT	DR	GLC	HYP	NML	OTH	PM
DenseNet121	0.52	0.77	0.55	0.38	0.18	0.48	0.36	0.78
InceptionV3	0.52	0.76	0.52	0.46	0.26	0.68	0.43	0.80
MobileNetV2	0.56	0.75	0.52	0.49	0.23	0.54	0.31	0.85
Xception	0.57	0.77	0.58	0.53	0.20	0.62	0.40	0.84

The results in Table 6 indicate that the MobileNetV2 model outperforms the other models, but the Xception model also achieves results very close to them. Therefore, it can be said that both models outperform the others. To evaluate the impact of data augmentation on model performance, Figure 6 was generated by averaging the results from the models presented in Tables 3, 5, and 6.



**Figure 23.** The relationship between model performance and data augmentation quantity

As illustrated in Figure 6, the increase in the number of data augmentations impacted each class differently. For the Glaucoma and Myopia classes, increasing the dataset size to approximately 2.000 instances yielded more successful outcomes. In contrast, the Hypertension class exhibited better performance when the dataset size was increased to 3.500 instances. The Normal class demonstrated equal success at both 2.000 and 3.500 instances, but performance declined when the dataset size was increased to 10.000 instances. Conversely, the Diabetes class showed improved results with a dataset size increase up to 10.000 instances. Notably, the AMD and Cataract classes achieved consistent results regardless of the number of data augmentations applied. Based on the results from Tables 2, 3, 4, 5, and 6, as well as Figure 6, it can be concluded that augmenting the training data up to 2,000 data points provides a more balanced approach. To observe which class was classified better in models, the average of the obtained results was taken, and Figure 7 below was created. The above graph shows that the Xception model has generally outperformed the other models. However, it is observed that the MobileNetV2 model performs better on average for the AMD and Myopia classes compared to others. Using the Xception model for the identification of eye diseases seems to be a more successful approach.



**Figure 24.** Model F1 Score for each class

## CONCLUSION AND FUTURE REMARKS

The identification and classification of eye diseases are vital for preventing blindness. Thus, the early detection of these conditions is key to maintaining eye health. Diagnosing eye diseases necessitates the involvement of specialists, creating a demand for expert knowledge. Solutions that facilitate the diagnosis of eye diseases and reduce the need for specialists are required. Inspired by this motivation, we conducted this study using the ODIR dataset to facilitate experts' disease detection processes and ease their workload through automated analysis.

The results obtained within the scope of the study can be evaluated from two distinct perspectives: the classification success of the applied filters and the classification performance depending on the data quantity. The results show that Filter 1 particularly enhances the success of the Cataract class, while



Filter 2 positively affects the results of the Myopia class. Although increasing the amount of data to 10.000 for each class's training data did not significantly improve class-wise performance, it generally exhibited a tendency to balance the model's F1 scores. Augmenting each class's training data to around 2.000 instances to approach the number of instances in the Normal class yielded more successful results compared to augmenting each class's training data to 3.500 instances.

Another significant point is that certain models can effectively classify specific diseases. For example, the Xception model classifies Cataract disease more successfully compared to other models, while the InceptionV3 model also effectively classifies Myopia disease. The Xception model trained with the 3.500 augmented instances using Filter 1 achieved an F1 score of 0.89 for Cataract. Similarly, the MobileNetV2 model trained using Filter 2 and around 2.000 augmented samples achieved a score of 0.88 for Myopia. In this study, a multi-class approach is adopted since similar studies in this field are usually conducted with multi-label approaches. Based on the average classification success of the models obtained from Figures 6, 7 and 8, increasing each training data class to around 2.000 and training an Xception model by applying Filter 2 on the images would be an appropriate approach for the diagnosis and classification of eye diseases. However, this study has some limitations. For instance, the imbalance in the dataset significantly affects the performance of the models. In future research, balancing the dataset with different data augmentation techniques and utilizing various preprocessing techniques could be considered. This way, classification performance can be improved for other classes as well.

In conclusion, this study demonstrates that deep learning architectures are promising tools for classifying ophthalmic diseases. Future research efforts may accelerate the use of these technologies in clinical applications and contribute significantly to the early diagnosis and treatment of eye diseases.

## REFERENCES

- Bhati, A., Gour, N., Khanna, P., & Ojha, A., 2023. *Discriminative kernel convolution network for multi-label ophthalmic disease detection on imbalanced fundus image dataset*. Computers in Biology and Medicine, 153:106519. doi: doi.org/10.1016/j.compbimed.2022.106519.
- Burton, M.J., Ramke, J., Marques, A.P., Bourne, R.R., Congdon, N., & Jones, I., 2021. *Lancet küresel sağlık komisyonu küresel göz sağlığı 2020'nin Ötesine Vizyon*. Lancet Glob Health, e489-e551.
- Chollet, F., 2017. *Xception: Deep Learning with Depthwise Separable Convolutions*. 2017 IEEE Conference on Computer Vision and Pattern Recognition (CVPR), Honolulu, HI, USA, pp. 1800-1807. doi: 10.1109/CVPR.2017.195.
- Huang, G., Liu, Z., Van Der Maaten, L., & Weinberger, K.Q., 2017. *Densely Connected Convolutional Networks*. 2017 IEEE Conference on Computer Vision and Pattern Recognition (CVPR), Honolulu, HI, USA, pp. 2261-2269. doi: 10.1109/CVPR.2017.243.
- Lin, J., Cai, Q., & Lin, M., 2021. *Multi-Label Classification of Fundus Images With Graph Convolutional Network and Self-Supervised Learning*. IEEE Signal Processing Letters, 28, pp. 454-458. doi: 10.1109/LSP.2021.3057548.
- Lu, Z., Miao, J., Dong, J., Zhu, S., Wu, P., Wang, X., & Feng, J., 2023. *Automatic Multilabel Classification of Multiple Fundus Diseases Based on Convolutional Neural Network With Squeeze-and-Excitation Attention*. Translational Vision Science & Technology, 12(1):22. doi: doi.org/10.1167/tvst.12.1.22.
- Mohamed, M.A., Zakaria, M.A., Hamdi, E., Tawfek, R., Taha, T.M., Afify, Y.M., Elshinawy, R.W., & Ahmed, M.H., 2023. *Multi-class eye disease classification using deep learning*. 2023 IEEE Eleventh International Conference on Intelligent Computing and Information Systems (ICICIS), pp. 1-6. doi: 10.1109/ICICIS58388.2023.10391159.
- Sandler, M., Howard, A., Zhu, M., Zhmoginov, A., & Chen, L.-C., 2018. *MobileNetV2: Inverted Residuals and Linear Bottlenecks*. 2018 IEEE/CVF Conference on Computer Vision and Pattern Recognition, Salt Lake City, UT, USA, pp. 4510-4520. doi: 10.1109/CVPR.2018.00474.
- Shanggong Medical Technology Co., Ltd., 2020. *Ocular Disease Recognition (ODIR-5k) Dataset*. Access address: <https://www.kaggle.com/datasets/andrewmvd/ocular-disease-recognition-odir5k>; Date of access: 05.17.2024.
- Szegedy, C., Vanhoucke, V., Ioffe, S., Shlens, J., & Wojna, Z., 2016. *Rethinking the Inception Architecture for Computer Vision*. 2016 IEEE Conference on Computer Vision and Pattern Recognition (CVPR), Las Vegas, NV, USA, pp. 2818-2826. doi: 10.1109/CVPR.2016.308.

Wang, J., Yang, L., Huo, Z., He, W., & Luo, J., 2020. *Multi-label classification of fundus images with EfficientNet*. IEEE Access, 8, pp. 212499-212508. doi: 10.1109/ACCESS.2020.3040275.  
World Health Organization, 2019. *World Report on Vision*. Access address: <https://iris.who.int/bitstream/handle/10665/328717/9789241516570-eng.pdf?sequence=18>; Date of access: 05.20.2024.

#### **Acknowledgment**

In this section, acknowledgments can be made to the persons or institutions who supported the study.

#### **Conflict of Interest**

If there is no conflict of interest of the authors, it should be written as "The authors have declared that there is no conflict of interest".

#### **Author Contributions**

All authors completed the study by taking sufficiently equal responsibility for the study.



**Analysis of Dynamics between Bacteria-Multiple Antibiotic by Using Incommensurate Fractional-Order System**

**Esra SÖNMEZ<sup>1</sup>, Bahatdin DAŞBAŞI<sup>2\*</sup>**

<sup>1</sup>Kayseri University, Graduate Education Institute, Computational Sciences and Engineering Department, 38280, Kayseri, Türkiye

<sup>2</sup>Kayseri University, Faculty of Engineering, Architecture and Design, Department of Engineering Basic Sciences, 38280, Kayseri, Türkiye

\*Corresponding author e-mail: bdasbasi@kayseri.edu.tr

**Abstract**

*Mathematical model that examines the dynamics of bacteria and antibiotic concentrations in an infected individual taking cocktail of multiple-antibiotic cure has been proposed through incommensurate fractional-order differential equation (FODE) system including the Caputo fractional derivative. The stability for  $R_0 < 1$  of the infection-free equilibrium point, which all the time existed, and the stability of the endemic equilibrium point, which existed when  $R_0 > 1$ , were analyzed according to the introduced threshold parameter  $R_0$  where conditions obtained newly in this study. The outcomes of analysis were promoted through numerical simulations by using the data procured from literature, considering the antibiotics isoniazid (INH), rifampicin (RIF), streptomycin (SRT), pyrazinamide (PZA) for Mycobacterium Tuberculosis (Mtb), the antibiotics imipenem (IPM) and ciprofloxacin (CIP) for Escherichia Coli (E. coli) and the antibiotics IPM and CIP for Acinetobacter Baumannii (A. Baumannii). The results obtained in numerical studies have been consistent exactly real situations. In this context, results compatible with the recommended treatment periods for above-mentioned bacterial infections were obtained. Furthermore, it has been demonstrated that our proposed model gives very successful results (low RMSE value) according to some values of the given variables for an arbitrary infection situation.*

**Keywords:** Fractional-Order Differential Equation, Bacterial Infection Model, RMSE.

**1. INTRODUCTION**

FODEs form the basis of many studies, as they frequently appear in a variety of implementations in engineering, biomathematics, fluid mechanics, economics, viscoelasticity, biology, physics and medicine. Lately, many studies have been presented on the applications of FODEs in nonlinear dynamics (Baleanu et al., 2019; Baleanu et al., 2020; Daşbaşı, 2017; Daşbaşı, 2023; El-Saka et al., 2009; El-Saka and El-Sayed, 2013; El-Sayed et al., 2007; Ersoy et al. 2024; Joshi and Yavuz, 2023; Podlubny, 1999; Podlubny and El-Sayed, 1996).

For FODEs and their systems (FOSs), the stability of the equilibrium point is at least their integer order. By performing stability analysis of the equilibrium point of FOS through mathematical modeling, the behavior of the system can be predicted more comprehensively than with ODEs. In particular, biological population modeling with FODEs is a broad source of mathematical ideas (Öztürk et al., 2019). Additionally, for many biological systems, behavior has memory or aftereffects. Modeling such systems with FODEs is more advantageous than ODEs where these effects are neglected (Daşbaşı, 2017; Daşbaşı, 2019a). Considering the derivative-orders in the system, FOS can be contemplated in two sections: commensurate FOS (CFOS) and incommensurate (IFOS). (Daşbaşı, 2020). Also, modeling of biological dynamics through IFOS is more extensive with regard to estimating the behavior of the system.

It has been suggested that infections are the cause of many diseases in human history. Bacterial infections, for which antibiotic treatment is used to combat, are particularly prominent (Daşbaşı and



Öztürk, 2016). There are many studies in the literature on mathematical modeling of bacterial infections. For some of these you can see: (Anzia and Rabajante, 2018; Daşbaşı, 2019b; Ibarğüen-Mondragón et al., 2019; Ibarğüen-Mondragón et al., 2021; Majchrzak, et al., 2020; Merdan et al., 2017; Mondragón et al., 2014).

This study considered an example of a host with a bacterial infection and taking multiple-antibiotic to treat it. The changes in antibiotic concentrations and bacterial population over time were examined by mathematical modeling with IFOS.

The organization of the rest of the paper is presented below.

- Some preliminary descriptions with respect to fractional derivative operators have been expressed in Section II. Then, the locally asymptotic stability (LAS) terms are stated.
- In Section III, the mathematical form of bacterial infection model is presented.
- In Section IV, the qualitative analysis of the model is given.
- In Section V, to support the qualitative analysis outcomes of model, numerical simulations were practiced by using the data obtained from literature, by considering the antibiotics INH, RIF, SRT and PZA for Mtb, the antibiotics IPM and CIP for E. coli and the antibiotics IPM and CIP for A. baumannii.
- The parameters in the proposed model for a random infection case were estimated in Section VI. Additionally, the performance of the model was evaluated according to different derivative orders.
- The paper is finished with some concluding remarks in Section VII.

## 2. Preliminaries and Definitions

**Definition 2.1.** There are variety descriptions of a fractional-order derivative with the order  $\alpha > 0$ . The Riemann-Liouville and Caputo definitions are probably the most common and oldest in the literature. The Riemann-Liouville fractional integral operator with order  $\alpha \geq 0$  for the function  $f(t)$  is described as the following:

$$J^\alpha f(t) = \frac{1}{\Gamma(\alpha)} \int_0^t (t-\tau)^{\alpha-1} f(\tau) d\tau, \alpha > 0, t > 0. \quad (1)$$

Some of characteristics of the operator  $J^\alpha$  are

$$\begin{aligned} J^\alpha J^\beta f(t) &= J^{\alpha+\beta} f(t) \\ J^\alpha t^\gamma &= \frac{\Gamma(\gamma+1)}{\Gamma(\alpha+\gamma+1)} t^{\alpha+\gamma} \end{aligned} \quad (2)$$

where  $\mu \geq -1, \alpha, \beta \geq 0$  and  $\gamma > -1$ . By the description of Caputo, the fractional derivative of  $f(t)$  is defined as

$$D^\alpha f(t) = J^{m-\alpha} D^m f(t) = \frac{1}{\Gamma(m-\alpha)} \int_0^t \frac{f^{(m)}(\tau)}{(t-\tau)^{\alpha-m+1}} d\tau \quad (3)$$

for  $m-1 < \alpha \leq m, m \in \mathbb{N}, t > 0$  (Owolabi, 2018).

**Remark 2.1.** Consider the nonlinear FOS given below as

$$\begin{aligned} \frac{d^\alpha X(t)}{dt^\alpha} &= F(t, X(t)), \\ X(0) &= X_0. \end{aligned} \quad (4)$$

In here,  $X(t) = [x_1(t), x_2(t), \dots, x_n(t)]^T \in \mathbb{R}^n$  is the state vectors of Eqs. (4),  $F = [f_1, f_2, \dots, f_n]^T \in \mathbb{R}^n$ ,  $f_i: [0, +\infty) \times \mathbb{R}^n \rightarrow \mathbb{R}$ , ( $i = 1, 2, \dots, n$ ),  $\bar{\alpha} = [\alpha_1, \alpha_2, \dots, \alpha_n]^T$  is the multi-order of Eqs. (5),  $\frac{d^{\bar{\alpha}} X(t)}{dt^{\bar{\alpha}}} =$

$$\left[ \frac{d^{\alpha_1} x_1(t)}{dt^{\alpha_1}}, \frac{d^{\alpha_2} x_2(t)}{dt^{\alpha_2}}, \dots, \frac{d^{\alpha_n} x_n(t)}{dt^{\alpha_n}} \right]^T \quad (\text{Yude et al., 2010; Daşbaşı, 2018}).$$

In the remainder of the article, it is assumed that  $\alpha_i \in (0, 1]$ .

**Definition 2.3.** Let us consider that  $\alpha_1 = \alpha_2 = \dots = \alpha_n = \alpha$ . Thus, Eqs. (4) can be rewritten as

$$\frac{d^\alpha X(t)}{dt^\alpha} = F(t, X(t)), \quad (5)$$

namely the commensurate FOS. On the contrary, Eqs. (4) is called as incommensurate FOS (Razminia et al., 2011).

**Definition 2.4.** The autonomous IFOS in Eqs. (4) can be described as

$$\frac{d^\alpha X(t)}{dt^\alpha} = F(X(t)), \quad (4)$$

$$X(0) = X_0.$$

The fixed point (or equilibrium point) of Eqs. (6) is the point  $\bar{X} = (\bar{x}_1, \bar{x}_2, \dots, \bar{x}_n)$  calculated from  $F(\bar{X}) = 0$ . (7)

**Lemma 2.1.** Eigenvalues  $\lambda_i$  for  $i = 1, 2, \dots, m(\alpha_1 + \alpha_2 + \dots + \alpha_n)$  of Eqs. (6) are found by the characteristic equation evaluated as

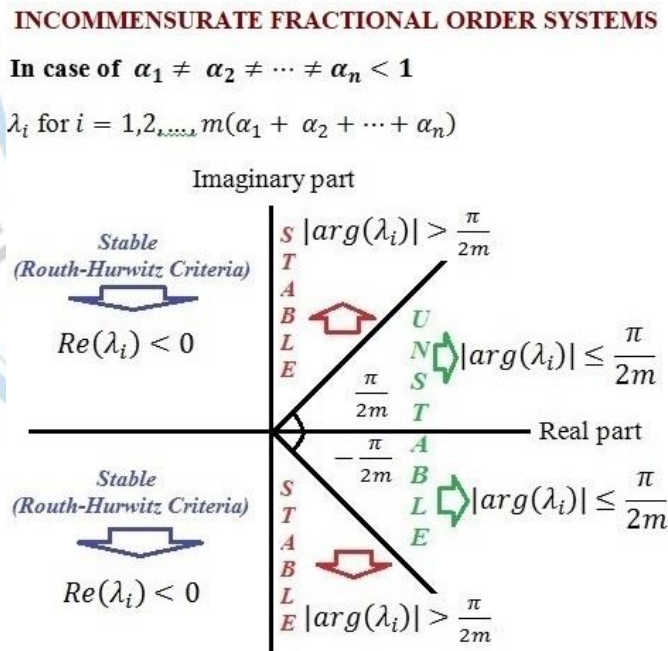
$$\det(\text{diag}(\lambda^{m\alpha_1}, \lambda^{m\alpha_2}, \dots, \lambda^{m\alpha_n}) - J(\bar{X})) = 0, \quad (8)$$

where  $m$  is taken into consideration as the lowest common multiple (LCM) of the denominators of rational numbers  $\alpha_1, \alpha_2, \dots, \alpha_n$ . In addition that, it is  $J(\bar{X}) = \left. \frac{\partial F}{\partial X} \right|_{X=\bar{X}}$ . When eigenvalues  $\lambda_i$  calculated by Eq. (8) carry out

$$|\arg(\lambda_i)| > \frac{\pi}{2m}, \quad (9)$$

$\bar{X}$  is LAS for IFOS in Eqs. (6) (Deng et al., 2007).

The stable and unstable regions the equilibrium point with respect to eigenvalue for IFOS in Eqs. (6) are shown in Figure 1.



**Figure 1.** Analysis of eigenvalues for IFOS in Eqs. (6) (Daşbaşı, 2020).

### 3. Mathematical Model

In the model proposed in this study, the dynamics of bacteria-multiple antibiotic therapy, which is created by IFOS, is presented. In model it is considered the situation of an individual having bacterial infection and taking multiple-antibiotic. Let us consider that  $B$  typify the bacterial population at time  $t$  and  $C_i$  for  $i = 1, 2, \dots, n$  represent the  $i$ -th antibiotic concentration at time  $t$ . Thus, the model for  $t > t_0$

is

$$\begin{aligned}
 D^{\alpha_1} B(t) &= \beta B \left(1 - \frac{B}{\delta}\right) - B \left[ \sum_{i=1}^n q_i C_i \right] - \eta B \\
 D^{\alpha_2} C_1(t) &= \Lambda_1 - \mu_1 C_1 \\
 &\vdots \\
 D^{\alpha_{n+1}} C_n(t) &= \Lambda_n - \mu_n C_n
 \end{aligned} \tag{10}$$

where initial conditions are  $B(0) = B_0, C_1(0) = C_{10}, \dots, C_n(0) = C_{n0}$ . Also, the derivative-orders in the model given as  $\alpha_1, \alpha_2, \dots, \alpha_{n+1}$  satisfy the following inequalities:

$$0 < \alpha_1, \alpha_2, \dots, \alpha_{n+1} \leq 1 \tag{11}$$

such that

$$k_1, k_2, \dots, k_n, m_1, m_2, \dots, m_n \in \mathbb{Z}^+ \tag{12}$$

and

$$\alpha_1 = \frac{k_1}{m_1}, \alpha_2 = \frac{k_2}{m_2}, \dots, \alpha_n = \frac{k_n}{m_n} \tag{13}$$

where  $m = \text{LCM}\{m_1, m_2, \dots, m_n\}$ .

In Eqs. (6), it is displayed by  $\beta$  the growth rate of bacteria, by  $\delta$  the carrying capacity of bacteria, by  $\eta$  the natural mortality rate of the bacteria and by  $q_i$  for  $i = 1, 2, \dots, n$  the mortality rate of the bacteria due to the  $i$ -th antibiotic. Additionally, the  $i$ -th antibiotic for  $i = 1, 2, \dots, n$  is taken in a fixed amount of  $\Lambda_i$  and is excreted from the body at a rate of  $\mu_i$ . Therefore, it is

$$\beta, \delta, \eta, q_i, \Lambda_i, \mu_i > 0 \tag{14}$$

The infection scenario mentioned above regarding the parameters in Eqs. (10) is illustrated in Figure 2.

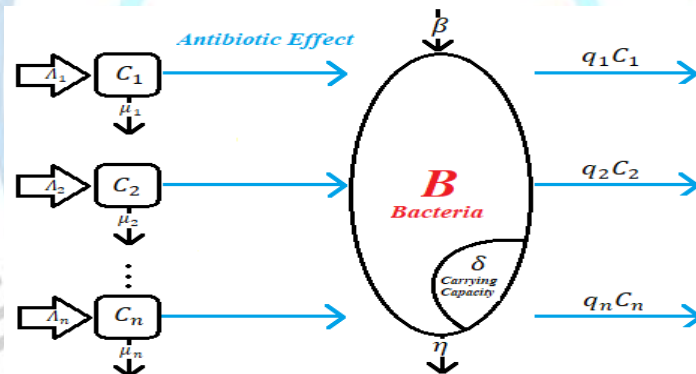


Figure 2. Figural representation of Eqs. (10).

**Definition 3.1.** Eqs. (10) is rewritten in the following matrix version:

$$\begin{aligned}
 D^{\alpha_i} X(t) &= f(X(t)) = P_1 X(t) + x_1(t) P_2 X(t) + P_3 \\
 X(0) &= X_0
 \end{aligned} \tag{15}$$

where



$$P_1 = \begin{pmatrix} (\beta-\eta) & 0 & 0 & \dots & 0 \\ 0 & -\mu_1 & 0 & \dots & 0 \\ 0 & 0 & -\mu_2 & \dots & 0 \\ \vdots & \vdots & \vdots & \ddots & \vdots \\ 0 & 0 & 0 & \dots & -\mu_n \end{pmatrix}, P_2 = \begin{pmatrix} 0 & q_1 & q_2 & \dots & q_n \\ 0 & 0 & 0 & \dots & 0 \\ 0 & 0 & 0 & \dots & 0 \\ \vdots & \vdots & \vdots & \ddots & \vdots \\ 0 & 0 & 0 & \dots & 0 \end{pmatrix} \quad (16)$$

$$P_3 = \begin{pmatrix} 0 \\ \Lambda_1 \\ \Lambda_2 \\ \vdots \\ \Lambda_n \end{pmatrix} \text{ and } X_0 = \begin{pmatrix} B(0) \\ C_1(0) \\ C_2(0) \\ \vdots \\ C_n(0) \end{pmatrix} = \begin{pmatrix} x_1(0) \\ x_2(0) \\ x_3(0) \\ \vdots \\ x_{n+1}(0) \end{pmatrix}.$$

In here, it is shown the variables by  $X(t) = [x_1(t) \dots x_{n+1}(t)]^T = [B(t) C_1(t) \dots C_n(t)]^T \in R^{n+1}$ , the derivatives by  $D^{\alpha_i}X(t) = [D^{\alpha_1}x_1(t) \dots D^{\alpha_{n+1}}x_{n+1}(t)]^T$  and the functions by  $f = [f_1 \dots f_{n+1}]^T \in R^{n+1}$ ,  $f_i: [0, +\infty) \times R^{n+1} \rightarrow R$ .

**Definition 3.2.** For  $X(t) = (x_1(t) \dots x_{n+1}(t))^T$ , suppose  $C^*[0, T]$  is a set of continuous column vectors in the range  $[0, T]$ . In this sense, norm of the vector  $X(t) \in C^*[0, T]$  defined in (15) is indicated with  $\|X(t)\| = \sum_{i=1}^{n+1} \sup_t |x_i(t)|$ .

**Proposition 3.1.** Let us pay regard to  $X(t) = (x_1(t) \dots x_{n+1}(t))^T$  in  $R_+^{n+1} = \{X \in R^{n+1} : x \geq 0\}$  and  $D^{\alpha_i}f(X) \in C[k_1, k_2]$  for  $i = 1, 2, \dots, (n+1)$ ,  $f(X) \in C[k_1, k_2]$ ,  $0 < \alpha_i \leq 1$ . With respect to generalized mean value theorem (Odibat and Momani, 2008), it is  $f(X) = f(k_1) + \frac{1}{\Gamma(\alpha)} D^{\alpha_i}f(\xi)(x-k_1)^{\alpha_i}$  for  $\forall x \in [k_1, k_2]$  and  $0 \leq \xi \leq x$ . For  $i = 1, 2, \dots, (n+1)$ ,

- when  $D^{\alpha_i}f(x) \geq 0$ , the function  $f(x)$  non-decreasing,
- when  $D^{\alpha_i}f(x) \leq 0$ , the function  $f(x)$  non-increasing.

In this case, the vector field is the points in  $R_+^{n+1}$ , since  $D^{\alpha_1}x_1(t)|_{x_1=x_2=\dots=x_{i+1}=0} = 0$ ,  $D^{\alpha_2}x_2(t)|_{x_1=x_2=\dots=x_{i+1}=0} = \Lambda_1 \dots$  and  $D^{\alpha_{i+1}}x_{i+1}(t)|_{x_1=x_2=\dots=x_{i+1}=0} = \Lambda_n$ .

**Proposition 3.2.** If  $X(t) \in C^*[0, T]$ , then there is a single solution of Eqs. (15).

**Proof** Let  $D^{\alpha}X(t) = P_1X(t) + x_1(t)P_2X(t) + P_3$ . Thus, it is  $G(X(t)) \in C^*[0, T]$  for the vector  $X(t) \in C^*[0, T]$ . For the vectors  $X(t), Z(t) \in C^*[0, T]$  such that  $X(t) \neq Z(t)$ , someone can point out the followings:

$$\begin{aligned}
 \|G(X(t))-G(Z(t))\| &= \|(P_1X(t) + x_1(t)P_2X(t) + P_3)-(P_1Z(t) + z_1(t)P_2Z(t) + P_3)\| \\
 &= \|P_1X(t) + x_1(t)P_2X(t)-P_1Z(t)-z_1(t)P_2Z(t)\| \\
 &= \left\| P_1(X(t)-Z(t)) + x_1(t)P_2X(t)-z_1(t)P_2Z(t) - \underbrace{(x_1(t)P_2Z(t)-z_1(t)P_2Z(t))}_0 \right\| \\
 &= \|P_1(X(t)-Z(t)) + x_1(t)P_2(X(t)-Z(t)) + (x_1(t)-z_1(t))P_2Z(t)\| \\
 &\leq \|P_1(X(t)-Z(t))\| + \|x_1(t)P_2(X(t)-Z(t))\| + \|(x_1(t)-z_1(t))P_2Z(t)\| \\
 &\leq \|P_1\| \|X(t)-Z(t)\| + |x_1(t)| \|P_2\| \|X(t)-Z(t)\| + \frac{|(x_1(t)-z_1(t))|}{\leq \|X(t)-Z(t)\|} \|P_2\| \|Z(t)\|
 \end{aligned}$$

$$\leq \left( \|P_1\| + \frac{|x_1(t)|}{\|X(t)\|} \|P_2\| + \|P_2\| \|Z(t)\| \right) \|(X(t)-Z(t))\|$$

$$\leq (\|P_1\| + \|X(t)\| \|P_2\| + \|P_2\| \|Z(t)\|) \|(X(t)-Z(t))\|$$

and so,

$$\|G(X(t))-G(Z(t))\| \leq L\|(X(t)-Z(t))\| \quad (17)$$

where  $L = \|U\| + (\|N_2\| + \|N_3\|)(\xi_1 + \xi_2) > 0$  such that  $\xi_1, \xi_2 \in \mathbb{R}^+$  and  $\|X(t)\| \leq \xi_1, \|Z(t)\| \leq \xi_2$  due to  $X(t), Z(t) \in C^*[0, T]$ . Thus, system (15) has a single solution.

#### 4. Stability Analysis

In this section, it has been presented the threshold parameter. Laterly, the existence of the equilibrium points of Eqs. (10) and its local asymptotic stability have been researched.

**Definition 4.1** Let the threshold parameter be defined as

$$R_0 = \frac{\beta}{\left[ \sum_{i=1}^n q_i \frac{\Lambda_i}{\mu_i} \right] + \eta}, \quad (18)$$

where it is clear that

$$R_0 > 0 \quad (19)$$

due to Ineqs. (14). The threshold parameter  $R_0$  mentioned in here is often referred to as the growth rate or the baseline growth rate. Additionally, this parameter is considered to evaluate the transmission tendency of the disease. Biologically, considering infected and uninfected cells in a host, the parameter is the average number of newly infected cells generated by a single infected cell when nearly all cells are still uninfected.

**Proposition 4.1** (Equilibrium Points) Considering Eqs. (10). Although  $E_0 \left( 0, \frac{\Lambda_1}{\mu_1}, \frac{\Lambda_2}{\mu_2}, \dots, \frac{\Lambda_n}{\mu_n} \right)$ , namely the infection-free equilibrium point, always exists, if  $R_0 > 1$ , then  $E_1 \left( \delta \left( 1 - \frac{1}{R_0} \right), \frac{\Lambda_1}{\mu_1}, \frac{\Lambda_2}{\mu_2}, \dots, \frac{\Lambda_n}{\mu_n} \right)$ , namely the positive equilibrium point (or endemic equilibrium point), exists.

**Proof** The equilibrium points of Eqs. (10) are obtained from the solution of the system  $\begin{cases} D^{\alpha_1} B(t) = 0 \\ D^{\alpha_j+1} C_i(t) = 0 \end{cases}$  for  $i, j = 1, 2, \dots, n$ . Therefore, it is found

$$B \left( \beta \left( 1 - \frac{B}{\delta} \right) - \left[ \sum_{i=1}^n q_i C_i \right] - \eta \right) = 0 \quad (20)$$

$$\Lambda_i - \mu_i C_i = 0$$

By solving this system,  $E_0 \left( 0, \frac{\Lambda_1}{\mu_1}, \frac{\Lambda_2}{\mu_2}, \dots, \frac{\Lambda_n}{\mu_n} \right)$  and  $E_1 \left( \frac{\beta \cdot \left[ \sum_{i=1}^n q_i \frac{\Lambda_i}{\mu_i} \right] - \eta}{\frac{\beta}{\delta}}, \frac{\Lambda_1}{\mu_1}, \frac{\Lambda_2}{\mu_2}, \dots, \frac{\Lambda_n}{\mu_n} \right)$  points are obtained.

Considering the threshold parameter  $R_0$  expressed in (18), the positive equilibrium point can also be rewritten as  $E_1 \left( \left( 1 - \frac{1}{R_0} \right) \delta, \frac{\Lambda_1}{\mu_1}, \frac{\Lambda_2}{\mu_2}, \dots, \frac{\Lambda_n}{\mu_n} \right)$ . In terms of Ineqs. (14) inequalities, the equilibrium point  $E_0$  always exists, but if

$$R_0 > 1, \quad (21)$$

then the equilibrium point  $E_1$  is biological meaning.

**Proposition 4.2** For Eqs. (10), we have the follows:

- i. If  $R_0 < 1$ , then  $E_0$  is LAS.
- ii. Let  $R_0 > 1$ . Therefore,  $E_1$  is LAS.

**Proof** The functions in Eqs. (10) are specified as

$$\begin{aligned} F_1(B, C_1, \dots, C_n) &= \beta B \left(1 - \frac{B}{\delta}\right) - B \left[ \sum_{i=1}^n q_i C_i \right] - \eta B \\ F_2(B, C_1, \dots, C_n) &= \Lambda_1 - \mu_1 C_1 \\ &\vdots \\ F_{n+1}(B, C_1, \dots, C_n) &= \Lambda_n - \mu_n C_n \end{aligned} \quad (22)$$

The Jacobian matrix evaluated from (22) through partial derivatives such that  $J =$

$$\begin{pmatrix} \frac{\partial F_1}{\partial B} & \frac{\partial F_1}{\partial C_1} & \dots & \frac{\partial F_1}{\partial C_n} \\ \frac{\partial F_2}{\partial B} & \frac{\partial F_2}{\partial C_1} & \dots & \frac{\partial F_2}{\partial C_n} \\ \vdots & \vdots & \ddots & \vdots \\ \frac{\partial F_{n+1}}{\partial B} & \frac{\partial F_{n+1}}{\partial C_1} & \dots & \frac{\partial F_{n+1}}{\partial C_n} \end{pmatrix} \text{ is as follows:}$$

$$J = \begin{pmatrix} \beta \left(1 - \frac{B}{\delta}\right) - \beta B \left(\frac{1}{\delta}\right) - \left[ \sum_{i=1}^n q_i C_i \right] - \eta & -Bq_1 & \dots & -Bq_n \\ 0 & -\mu_1 & \dots & 0 \\ \vdots & \vdots & \ddots & \vdots \\ 0 & 0 & \dots & -\mu_n \end{pmatrix}_{(n+1) \times (n+1)} \quad (23)$$

For LAS of the equilibrium point, Lemma 2.1. is considered.

i. The matrix

$$J(E_0) = \begin{pmatrix} \left( \beta - \left[ \sum_{i=1}^n q_i \frac{\Lambda_i}{\mu_i} \right] - \eta \right) & 0 & \dots & 0 \\ 0 & -\mu_1 & \dots & 0 \\ \vdots & \vdots & \ddots & \vdots \\ 0 & 0 & \dots & -\mu_n \end{pmatrix} \quad (24)$$

for  $i, j = 1, 2, \dots, n$  is obtained by computing the Jacobian matrix in (23) at the equilibrium point  $E_0$ . By means of  $\det(\text{diag}(\lambda^{m\alpha_1}, \lambda^{m\alpha_2}, \dots, \lambda^{m\alpha_{n+1}}) - J(E_0)) = 0$ , the equation for eigenvalues is

$$\left( \lambda^{m\alpha_1} - \left( \beta - \left[ \sum_{i=1}^n q_i \frac{\Lambda_i}{\mu_i} \right] - \eta \right) \right) (\lambda^{m\alpha_2} + \mu_1) \dots (\lambda^{m\alpha_{n+1}} + \mu_n) = 0. \quad (25)$$

From (22), it is

$$\lambda^{m\alpha_1} = \left( \beta - \left[ \sum_{i=1}^n q_i \frac{\Lambda_i}{\mu_i} \right] - \eta \right), \lambda^{m\alpha_2} = -\mu_1, \dots, \lambda^{m\alpha_{n+1}} = -\mu_n. \quad (26)$$

From here, let's examine that the stability of the equilibrium point in the way of the signs of the eigenvalues.

Consider  $\lambda^{m\alpha_2} = -\mu_1$ . Because of Ineqs. (14), it is clear that  $\lambda^{m\alpha_2}$  is a negative real number. Considering the De-Moivre formulas, it is  $\lambda^{m\alpha_2} = \mu_1 \text{cis}(2n+1)\pi$ , and so,

$$\lambda_i = \mu_1^{\frac{1}{m\alpha_2}} \text{cis} \frac{(2n+1)\pi}{m\alpha_2} \quad (27)$$

for  $n \in Z^+$   $i = 1, 2, \dots, m\alpha_2$  such that  $\text{cis}\pi = \cos \pi + i \sin \pi, i = \sqrt{-1}$ . Taking into consideration the stability condition of the equilibrium point  $E_0$  for (27), we have  $|\arg(\lambda)| = \left| \frac{(2n+1)\pi}{m\alpha_2} \right| > \frac{\pi}{2m}$  and

$$\alpha_2 < 2(2n+1) \quad (28)$$

for  $n \in Z^+$ . This situation is already provided by (11). When the analysis for the other equations in (26),  $\lambda^{m\alpha_3} = -\mu_2, \dots, \lambda^{m\alpha_{n+1}} = -\mu_n$ , is deduced in this way, the stability conditions for  $E_0$  do not deteriorate. Therefore, if  $\lambda^{m\alpha_1} = \left( \beta - \left[ \sum_{i=1}^n q_i \frac{\Lambda_i}{\mu_i} \right] - \eta \right) < 0$  or



$$\left( \beta - \left[ \sum_{i=1}^n q_i \frac{\Lambda_i}{\mu_i} \right] - \eta \right) < 0, \quad (29)$$

then stability conditions for the point  $E_0$  are satisfied. Let's arrange the inequality (29) according to the parameter  $R_0$ . In this case, when

$$R_0 < 1, \quad (30)$$

$E_0$  is LAS.

- ii. Let  $R_0 > 1$ . Thus,  $E_1$  is biologically meaningful. If the Jacobian matrix is calculated by (23) for this equilibrium point, then

$$J(E_1) = \begin{pmatrix} -\left( \left[ \sum_{i=1}^n q_i \frac{\Lambda_i}{\mu_i} \right] + \eta \right) (R_0 - 1) & -q_1 \left( 1 - \frac{1}{R_0} \right) \delta & \dots & -q_n \left( 1 - \frac{1}{R_0} \right) \delta \\ 0 & -\mu_1 & \dots & 0 \\ \vdots & \vdots & \ddots & \vdots \\ 0 & 0 & \dots & -\mu_n \end{pmatrix} \quad (31)$$

is found. The equations for the eigenvalues by  $\det(\text{diag}(\lambda^{\mu\alpha_1}, \lambda^{\mu\alpha_2}, \dots, \lambda^{\mu\alpha_{n+1}}) - J(E_1)) = 0$  are as follows:

$$\left( \lambda^{\mu\alpha_1} + \left( \left[ \sum_{i=1}^n q_i \frac{\Lambda_i}{\mu_i} \right] + \eta \right) (R_0 - 1) \right) (\lambda^{\mu\alpha_2} + \mu_1) \dots (\lambda^{\mu\alpha_{n+1}} + \mu_n) = 0. \quad (32)$$

Therefore, we have

$$\lambda^{\mu\alpha_1} = -\left( \left[ \sum_{i=1}^n q_i \frac{\Lambda_i}{\mu_i} \right] + \eta \right) (R_0 - 1), \quad \lambda^{\mu\alpha_2} = -\mu_1, \dots, \lambda^{\mu\alpha_{n+1}} = -\mu_n. \quad (33)$$

Let's take a similar approach to the thinking in the analysis of the  $E_0$  stability of the proof. In this case, It is sufficient to review the sign of the first equation in (33). If  $\lambda^{\mu\alpha_1} = -\left( \left[ \sum_{i=1}^n q_i \frac{\Lambda_i}{\mu_i} \right] + \eta \right) (R_0 - 1) < 0$  or

$$R_0 > 1 \quad (34)$$

due to Ineqs. (14) and (16), then stability conditions for  $E_1$  are provided. This situation in (34) already coincides with the existence condition of  $E_1$ . When  $E_1$  is meaningful, it is LAS.

Proof is completed.

Thus, Table 1 can be accessed for the above results regarding the equilibrium points.

**Table 1.** Stability analysis of the proposed model

Fixed Point	Existing State	Stability State
$E_0 \left( 0, \frac{\Lambda_1}{\mu_1}, \frac{\Lambda_2}{\mu_2}, \dots, \frac{\Lambda_n}{\mu_n} \right)$	Always exists	If $R_0 < 1$
$E_1 \left( \delta \left( 1 - \frac{1}{R_0} \right), \frac{\Lambda_1}{\mu_1}, \frac{\Lambda_2}{\mu_2}, \dots, \frac{\Lambda_n}{\mu_n} \right)$	If $R_0 > 1$	Stable

**Proposition 4.3** According to Table 1, considering the equilibrium points,  $E_0$  and  $E_1$  of Eqs. (10), these points can't be LAS when the same conditions occur.

**Proof** Let us consider Table 1. Although the equilibrium point  $E_0$  always exists, it is stable when  $R_0 < 1$ , in which case the equilibrium point  $E_1$  is meaningless. Alike, when  $R_0 > 1$ ,  $E_1$  equilibrium point is both meaningful and stable, but in this case  $E_0$  equilibrium point exists but is unstable.

## 5. Numerical Studies

**V. INTERNATIONAL APPLIED STATISTICS CONGRESS (UYIK - 2024)**  
**İstanbul / Türkiye, May 21-23, 2024**

In this section, the stability analysis outcomes in Table 1 of the proposed model are promoted via numerical simulations. For this reason, three different numerical studies were performed. Simulations comprise of *Mtb*, *E. coli* and *A. Baumannii*, respectively and the multiple antibiotic INH, RIF, SRT, PZA, IPM and CIP. The literature values corresponding to the parameters used in the proposed model are presented in Table 2.

**Table 2.** Considered values of parameters in the proposed model and their references

Parameter	For <i>Mtb</i>		For <i>E. coli</i>		For <i>A. baumannii</i>	
	Value	Reference	Value	Reference	Value	Reference
$\beta$	0.8 day <sup>-1</sup>	(Mondragón et al., 2014)	0.6 day <sup>-1</sup>	(Fujikawa et al., 2004)	1.2 day <sup>-1</sup>	(Antunes et al., 2011)
$\eta$	0.312 day <sup>-1</sup>	(Mondragón et al., 2014)	0.179 day <sup>-1</sup>	(Syed-Mohamed, 2013)	0.312 day <sup>-1</sup>	Hypothesis
$\delta$	10 <sup>9</sup> bacteria	(Coll, 2009)	10 <sup>7</sup> bacteria	(Carruthers et al., 2013)	10 <sup>8</sup> bacteria	(Carruthers et al., 2013)
$q_1$	0.0039 day <sup>-1</sup> (INH)	(Zhang, 2009)	0.42 day <sup>-1</sup> (IPM)	(Gur et al., 2009)	0.47 day <sup>-1</sup> (IPM)	(Gur et al., 2009)
$q_2$	0.00375 day <sup>-1</sup> (RIF)	(Mondragón et al., 2014)	0.17 day <sup>-1</sup> (CIP)	(Hadadi et al., 2007)	0.21 day <sup>-1</sup> (CIP)	(Hadadi et al., 2007)
$q_3$	0.0025 day <sup>-1</sup> (SRT)	(Alavez-Ramírez et al., 2007)	-	-	-	-
$q_4$	0.00001625 day <sup>-1</sup> (PZA)	(Alavez-Ramírez et al., 2007)	-	-	-	-
$\Lambda_1$	5 mg/kg/day (INH)	(Coll, 2009)	2-3 mg/kg/day (IPM)	(MacVaneet al., 2014)	2-3 mg/kg/day (IPM)	(MacVaneet al., 2014)
$\Lambda_2$	10 mg/kg/day (RIF)	(Coll, 2009)	1.2 mg/kg/day (CIP)	(MacVaneet al., 2014)	1.2 mg/kg/day (CIP)	(MacVaneet al., 2014)
$\Lambda_3$	15 mg/kg/day (SRT)	(Coll, 2009)	-	-	-	-
$\Lambda_4$	20 mg/kg/day (PZA)	(Coll, 2009)	-	-	-	-
$\mu_1$	0.06 day <sup>-1</sup> (INH)	(Esteva et al., 2011)	0.04 day <sup>-1</sup> (IPM)	(MacVaneet al., 2014)	0.04 day <sup>-1</sup> (IPM)	(MacVaneet al., 2014)
$\mu_2$	0.05 day <sup>-1</sup> (RIF)	(Esteva et al., 2011)	0.03 day <sup>-1</sup> (CIP)	(MacVaneet al., 2014)	0.03 day <sup>-1</sup> (CIP)	(MacVaneet al., 2014)
$\mu_3$	0.04 day <sup>-1</sup> (SRT)	(Esteva et al., 2011)	-	-	-	-
$\mu_4$	0.03 day <sup>-1</sup> (PZA)	(Esteva et al., 2011)	-	-	-	-

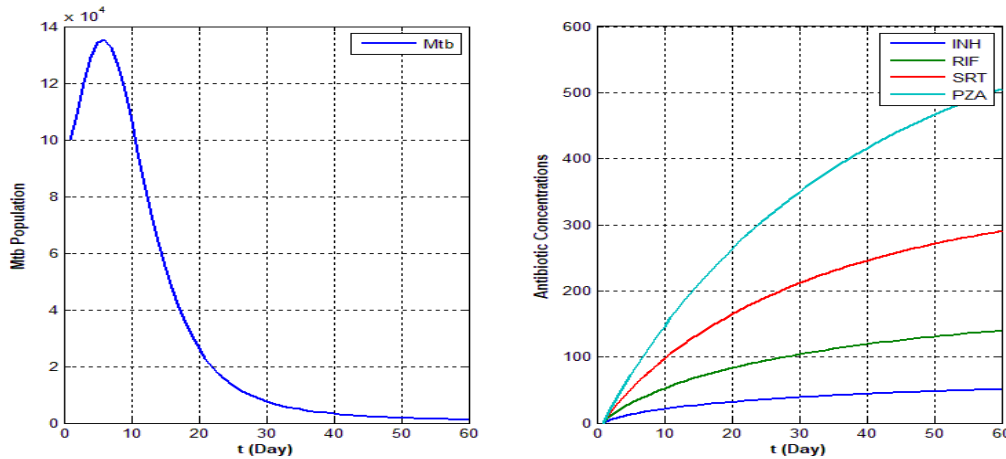
**5.1. Study for *Mtb***

Cure strategies regimens recommended of WHO for *Mtb* involve INH, RIF, SRT and PZA (Mondragón

et al., 2014). Therefore, the bacteria and antibiotics mentioned above have been handled in our numerical study. The treatment period of this infection is considered to be approximately 6 months on average. In this sense, it is suggested to receive INH, RIF, SRT and PZA antibiotics in the first two months, and INH and RIF antibiotics in the remaining 4-months.

When values in Table 2 are used for the first 2 months of treatment, the threshold parameter expressed in Definition 3.1 is found as  $R_0 = 0.344$ . Since  $R_0 < 1$ , it is concluded that the equilibrium point  $E_0(0,83.33,200,375,666.66)$  is stable. Also,  $E_1$  is not biologically meaningful.

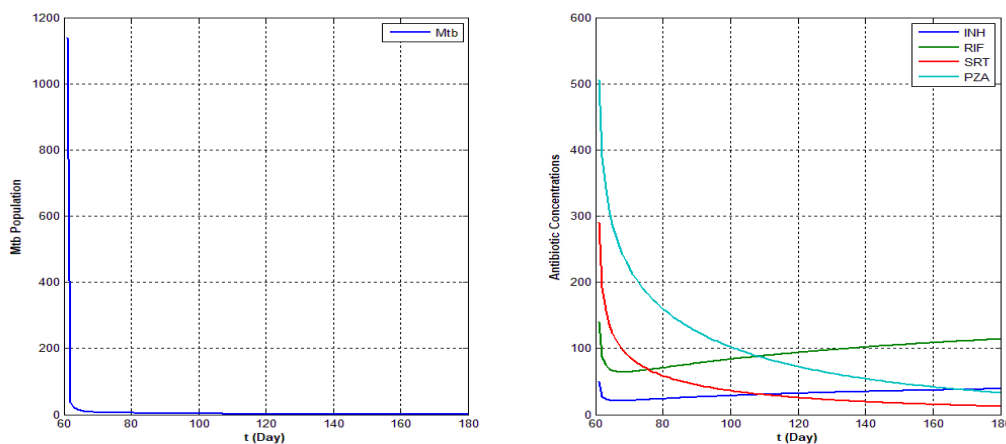
Let the derivatives-orders by  $[\alpha_1 \alpha_2 \alpha_3 \alpha_4 \alpha_5] = [0.6 \ 0.7 \ 0.8 \ 0.9 \ 0.95]$  and the initial conditions by  $[B_0 \ C_{1_0} \ C_{2_0} \ C_{3_0} \ C_{4_0}] = [10^6 \ 0 \ 0 \ 0 \ 0]$ . In this case, the numerical simulation for Mtb is found by Figure 3.



**Figure 3.** Time-dependent changes of the variables in the proposed model in the first 2 months of treatment, including INH, RIF, SRT and PZA, for Mtb

When the values in Table 2 have been evaluated for the last 4 months of treatment, it is  $R_0 = 0.581$ . Here, it is concluded that the equilibrium point  $E_0(0,83.33,200,0,0)$  is stable because of  $R_0 < 1$ .

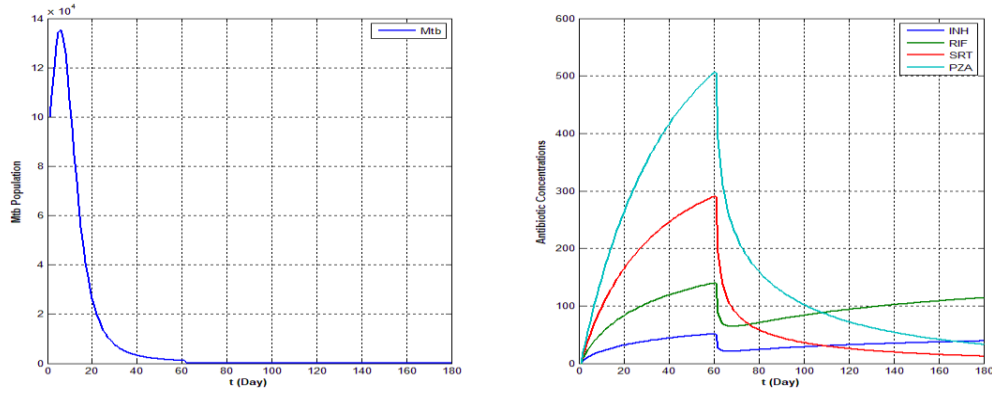
Let the derivative orders by  $[\alpha_1 \alpha_2 \alpha_3 \alpha_4 \alpha_5] = [1 \ 0.5 \ 0.6 \ 0.7 \ 0.8]$ . In addition,  $[B_0 \ C_{1_0} \ C_{2_0} \ C_{3_0} \ C_{4_0}] = [1138 \ 51.24 \ 139.8 \ 290.4 \ 505.8]$  values obtained at the end of the first 2 months become the newly initial conditions. In this case, Figure 4. are obtained.



**Figure 4.** Time-dependent changes of variables in the proposed model in the last 4 months of treatment, including INH, RIF, SRT and PZA, for Mtb

Let us consider Figures 1. and 2. together. In the Figures below, the time-dependent changes of the variables in the proposed model at the end of the entire 6-month treatment process are shown.

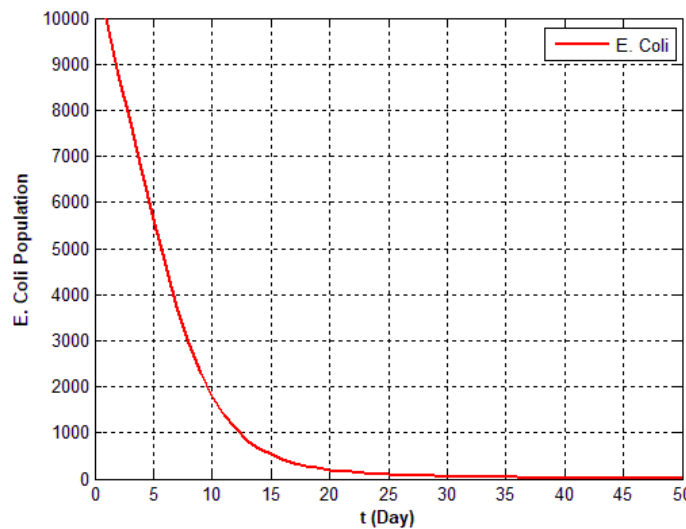




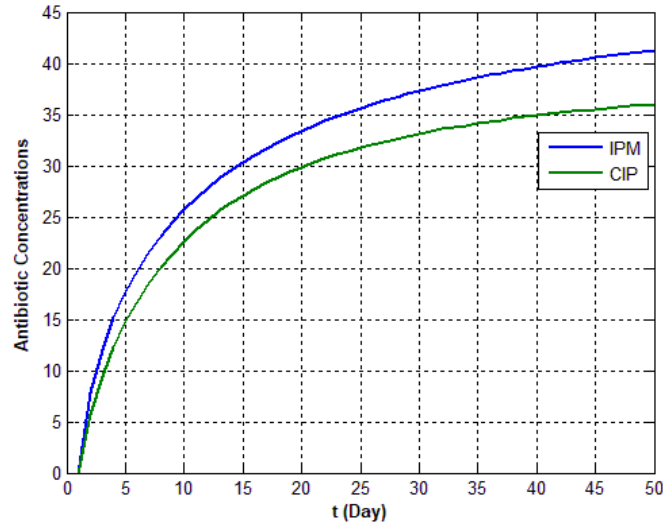
**Figure 5.** Time-dependent changes of variables in the proposed model during treatment, including INH, RIF, SRT and PZA, for Mtb

### 5.2. Study for E. coli

E. coli, a species of bacteria that usually persists in the human intestines, can cause life-threatening symptoms such as kidney failure, fever, bleeding and confusion. Among the recommended treatment strategies for the treatment of the disease are IPM and CIP (Gur et al., 2009; Hadadi et al., 2007). Considering Table 2 data, the threshold parameter is  $R_0 = 0.0214$ . This means the stability of the equilibrium point  $E_0(0,50,40)$  due to  $R_0 < 1$ . Let be the derivative-orders by  $[\alpha_1 \alpha_2 \alpha_3] = [.75 .70 .80]$  and by initial conditions by  $[B_0 C_{1_0} C_{2_0}] = [10^4 0 0]$ . Thus, Figures 6. and 7. are obtained through numeric solution of Eqs. (10).



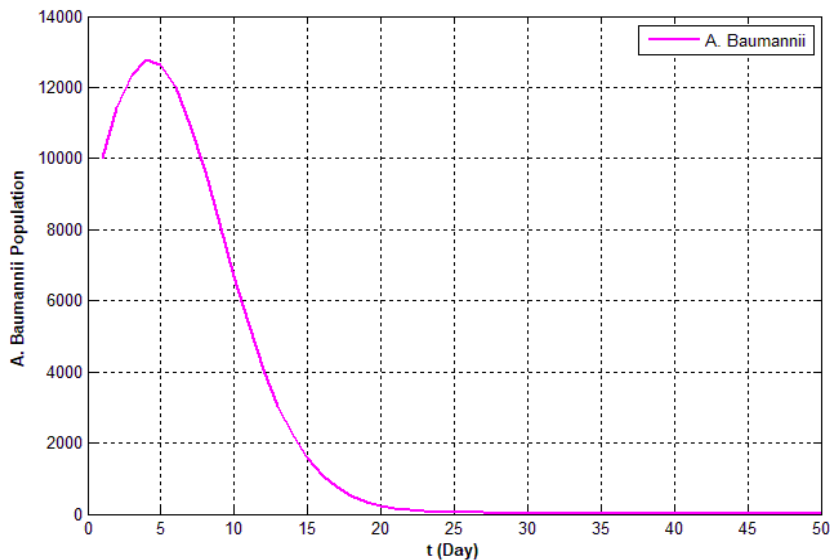
**Figure 6.** Time-dependent change of E. Coli population in the proposed model during treatment



**Figure 7.** Time-dependent changes of IPM and CIP concentrations in the proposed model during treatment for *E. coli*

### 5.3. Study for *A. baumannii*

Although there are many different types of *Acinetobacter*, a group of bacteria commonly found in the environment such as soil and water, the most common form is *Acinetobacter baumannii* in humans. This type of bacteria is known to cause fatal infections in the blood, urinary tract, and lungs or wounds in other parts of the body. The effects of IPM and CIP have been investigated in the literature for this bacterium (Gur et al., 2009; Hadadi et al., 2007). With respect to Table 2, it is  $R_0 = 0.0426$ . In this case, the infection-free equilibrium point  $E_0(0,50,40)$  is LAS as seen Figure 8.



**Figure 8.** Time-dependent changes of *A. baumannii* population in the proposed model during treatment for *A. Baumannii*

### 6. Parameter Estimation for Random Infection case

In this section, parameter values for the infection caused by a spontaneous *B* bacterium are taken into account. Moreover, let's assume that antibiotics  $c_1$  and  $c_2$  were used for this infection. The assumed time-dependent changes of  $B$ ,  $c_1$  and  $c_2$  variables during the 1-week treatment period are given in Table 3.

**Table 3.** Time dependent values of variables

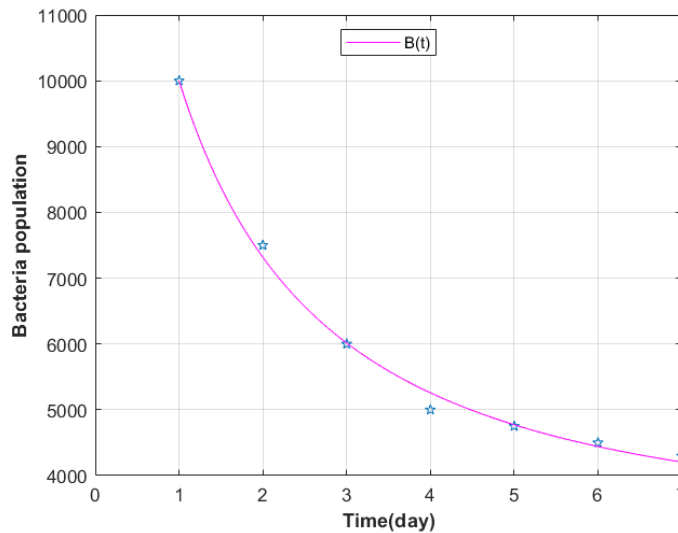
t	B(t)	C <sub>1</sub> (t)	C <sub>2</sub> (t)
1	10000	125	350
2	7500	175	400
3	6000	200	450
4	5000	230	475
5	4750	240	485
6	4500	245	490
7	4300	248	495

The infection model we first proposed with IFOS in (10) is presented here in ODE format. Then, the parameters of the ODE model were obtained with the lsqcurvefit function of the Matlab R2023b program, giving results close to the normalized values in Table 3. The reason for using normalized values  $(t/\|t\|, B/\|B\|, C_1/\|C_1\|, C_2/\|C_2\|)$  in here is that the error term is small and the program works more flexibly and easily to provide appropriate outputs. These parameter values were rewritten in the IFOS model in (10) and finally, an attempt was made to get closer to the values in Table 3 by using arbitrary derivative orders.

In this sense, the ODE model is

$$\begin{aligned} \frac{dB(t)}{dt} &= \beta B \left(1 - \frac{B}{\delta}\right) - B[q_1 C_1 + q_2 C_2] - \eta B, \\ \frac{dC_1(t)}{dt} &= \Lambda_1 - \mu_1 C_1, \\ \frac{dC_2(t)}{dt} &= \Lambda_2 - \mu_2 C_2. \end{aligned}$$

The parameter values obtained when the approach shown in (MathWorks, 2023) is used, are as follows: Rate Constants:  $\beta = 2.57123$ ,  $\delta = 0.20987$ ,  $q_1 = 0.00325$ ,  $q_2 = 0.00125$ ,  $\eta = 0.0451$ ,  $\Lambda_1 = 2.50561$ ,  $\mu_1 = 5.46536$ ,  $\Lambda_2 = 2.36663$  and  $\mu_2 = 5.58162$ . The relevant results are seen in Figure 9-11.



**Figure 9.** Curve fitted for the ODE model according to the actual values of B(t) marked by \*



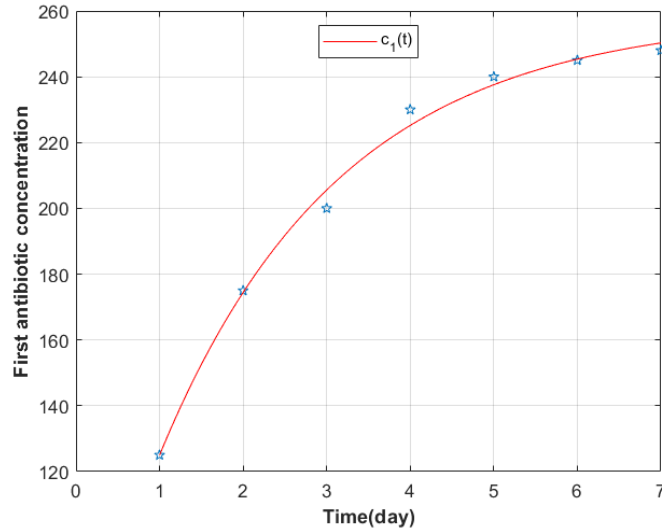


Figure 10. Curve fitted for the ODE model according to the actual values of  $C_1(t)$  marked by \*

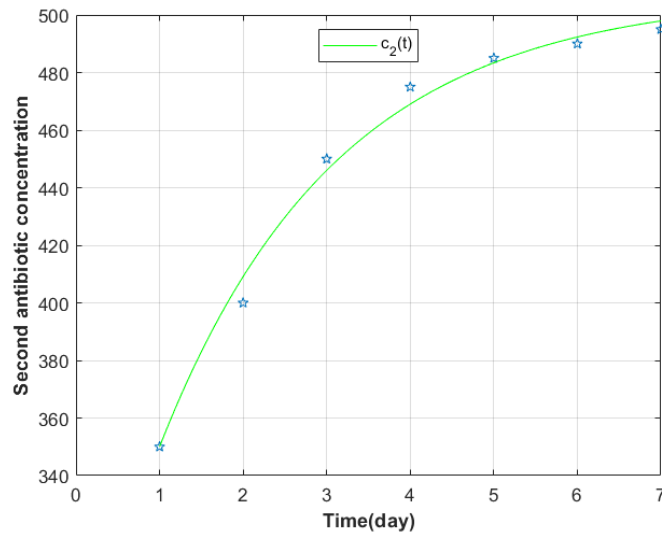


Figure 11. Curve fitted for the ODE model according to the actual values of  $C_2(t)$  marked by \*

On the other hand, let the derivative parameters be considered arbitrarily as  $\alpha_1 = 1$ ,  $\alpha_2 = .999$  ve  $\alpha_3 = .998$ . In this case, Table 4 is reached.

Table 3. Values of variables for different derivative orders

t	Default actual values			$\alpha_1 = \alpha_2 = \alpha_3 = 1$			$\alpha_1 = 1, \alpha_2 = .999$ and $\alpha_3 = .998$		
	B(t)	$C_1(t)$	$C_2(t)$	B(t)	$C_1(t)$	$C_2(t)$	B(t)	$C_1(t)$	$C_2(t)$
1	10000	125	350	10000	125	350	10000	125	350
2	7500	175	400	7362	173	410	7340	174	406
3	6000	200	450	6014	205	446	5999	205	445
4	5000	230	475	5240	225	468	5248	225	468
5	4750	240	485	4772	237	483	4761	237	483
6	4500	245	490	4550	245	492	4440	245	492
7	4300	248	495	4206	250	498	4205	250	498

Table 4 shows the estimated results obtained according to different situations of the derivative orders with the assumed real values. Although RMSE=298 in terms of Euclidean distance for  $\alpha_1 = \alpha_2 = \alpha_3 = 1$ , RMSE=316 for  $\alpha_1 = 1, \alpha_2 = .999$  and  $\alpha_3 = .998$ . This shows that results very close to the real values can be obtained when different derivative orders are used.

## 7. Conclusions

In this paper, it is recommended the new bacterial infection model consisting of the  $(n + 1)$  time-dependent variables: the bacteria population in individual and as the multiple antibiotic concentrations consisting of  $n$  antibiotics taken by individual for treatment the infection causing this bacteria. Proposed model is the form of nonlinear IFOS in Caputo meaning. Thus, the general conditions regarding the stability of the fixed points the model have been examined.

As seen in Table 1, the infection-free equilibrium point  $E_0 \left(0, \frac{\Lambda_1}{\mu_1}, \frac{\Lambda_2}{\mu_2}, \dots, \frac{\Lambda_n}{\mu_n}\right)$  and the positive equilibrium point  $E_1 \left(\delta \left(1 - \frac{1}{R_0}\right), \frac{\Lambda_1}{\mu_1}, \frac{\Lambda_2}{\mu_2}, \dots, \frac{\Lambda_n}{\mu_n}\right)$  and the stability states of these points were found depending on the threshold parameter  $R_0$ . This parameter can be expressed as the proliferative power of the bacteria.  $E_0$  always exists and is LAS when  $R_0 < 1$ . On the other hand,  $E_1$  exists when  $R_0 > 1$  and is LAS. Therefore, the existence and stability states of these equilibrium points have been found only depending on the threshold parameter, regardless of their derivative order in system.

In numerical studies, the dynamics of three different bacteria consisted of Mtb, E. Coli and A. Baumannii, and the multi-antibiotic therapy used against the infections caused by them, were examined. If the suitable dose and duration of antibiotics are applied to an infected individual, then these infections can be eliminated or their progression can be stopped. In this analysis, the antibiotic data used in the amount and time recommended in the literature were used. Here, results consistent with the recommended treatment duration were obtained. This shows how well our proposed model is at explaining real situations.

Additionally, considering a random infection situation, the bacterial population and the antibiotic concentrations used against it were presented as real values. Parameters were estimated based on these values. Then, the results obtained with different derivative orders were compared with the real values. In this context, very close results were found.

The reason for considering different derivative orders in this study is to take into account the delay that may occur in the values of any variable in the system, since it is inevitable that there will be a natural delay in most biological systems.

Considering the bacterial infection models in the literature, some innovations the proposed model in here are as follows:

- It is created by IFOS composing of  $(n + 1)$  equations.
- Our model suggested exactly the same treatment processes with the real conditions for some bacterial infections studied in this study.

## Conflict of Interest

The authors have declared that there is no conflict of interest.

## Author Contributions

ES: Software, Validation, Formal analysis, Writing – original draft, Writing – review & editing.

BD: Conceptualization, Methodology, Software, Validation, Formal analysis, Writing – original draft, Writing – review & editing, Visualization, Supervision.

## References

- Alavez-Ramírez J, Castellanos JR, Esteva L, Flores JA, Fuentes-Allen JL, García-Ramos G, . . . López-Estrada J, 2007. Within-host population dynamics of antibiotic-resistant M. tuberculosis. *Mathematical Medicine and Biology: A Journal of the IMA*, 24 (1): 35-56.
- Antunes LC, Imperi F, Carattoli A, Visca P, 2011. Deciphering the Multifactorial Nature of *Acinetobacter baumannii* Pathogenicity. *PLOSone*, 6 (e22674).
- Anzia EL, Rabajante JF, 2018. Antibiotic-driven escape of host in a parasite-induced Red Queen dynamics. *Royal Society open science*, 5 (9): 1-9.
- Baleanu D, Jajarmi A, Mohammadi H, Rezapour S, 2020. A new study on the mathematical modelling of human liver with Caputo–Fabrizio fractional derivative. *Chaos, Solitons and Fractals*, 134 (109705): 1-7.

- Baleanu D, Jajarmi A, Sajjadi SS, Mozyrska D, 2019. A new fractional model and optimal control of a tumor-immune surveillance with nonsingular derivative operator. *Chaos*, 29 (083127): 1-15.
- Carruthers MD, Nicholson PA, Tracy EN, Munson RS, 2013. *Acinetobacter baumannii* Utilizes a Type VI Secretion System for Bacterial Competition. *PLoSone*, 8 (e59388).
- Coll P, 2009. Fármacos con actividad frente a *Mycobacterium tuberculosis*. *Enfermedades Infecciosas y Microbiología Clínica*, 27 (8): 474-480.
- Daşbaşı B, Öztürk İ, 2016. Mathematical modelling of bacterial resistance to multiple antibiotics and immune system response. *SpringerPlus*, 5 (408): 1-17.
- Daşbaşı B, 2017. The Fractional-Order mathematical modeling of bacterial resistance against multiple antibiotics in case of local bacterial infection. *Sakarya University Journal of Science*, 251 (3): 1-16.
- Daşbaşı B, 2018. Stability Analysis of Mathematical Model including Pathogen-Specific Immune System Response with Fractional-Order Differential Equations. *Computational and Mathematical Methods in Medicine* 7930603: 1-10.
- Daşbaşı B, 2019a. Fractional-order Mathematical Modeling of Bacterial Competition with Therapy of Multiple Antibiotics. *Journal of New Theory*, 26: 90-103.
- Daşbaşı B, 2019b. *Mycobacterium Tuberculosis* için Genelleştirilmiş Kesirsel Mertebeden Matematiksel Modelin Kararlılık Analizi Üzerine. *Journal of the Institute of Science and Technology*, 9 (1): 272-287.
- Daşbaşı B, 2020. Stability analysis of the hiv model through incommensurate fractional-order nonlinear system. *Chaos, Solitons & Fractals*, 137 (109870): 1-12.
- Daşbaşı B, 2023. Fractional order bacterial infection model with effects of anti-virulence drug and antibiotic. *Chaos, Solitons & Fractals*, 170, 113331.
- Deng W, Li C, Guo Q, 2007. Analysis of Fractional Differential Equations with Multi-Orders. *Fractals*, 15 (2): 173-182.
- El-Saka H, El-Sayed A, 2013. *Fractional Order Equations and Dynamical Systems*. Germany: Lambert Academic Publishing.
- El-Saka H, Ahmed E, Shehata M, El-Sayed A, 2009. On stability, persistence and Hopf Bifurcation in fractional order dynamical systems. *Nonlinear Dyn.*, 56: 121-126.
- El-Sayed AM, El-Mesiry EM, El-Saka HA, 2007. On the fractional-order logistic equation. *AML*, 20: 817-823.
- Ersoy B, Daşbaşı B, Aslan E, 2024. Mathematical modelling of fiber optic cable with an electro-optical cladding by incommensurate fractional-order differential equations. *An International Journal of Optimization and Control: Theories & Applications (IJOCTA)*, 14(1): 50-61.
- Esteva L, Mondragon EI, Leyton JR, 2011. Un modelo matemático sobre bacterias sensibles y resistentes a antibióticos. *Matemáticas: Enseñanza Universitaria*, 19 (2): 55-73.
- Fujikawa H, Kai A, Morozumi S, 2004. A new logistic model for *Escherichia coli* growth at constant and dynamic temperatures. *Food Microbiol.*, 21: 501-509.
- Gur D, Hascelik G, Aydin N, Telli M, Gültekin M, Ogülcü D, . . . , Berktas, M, 2009. Antimicrobial resistance in gram-negative hospital isolates: results of the Turkish HITIT-2 Surveillance Study of 2007. *J. Chem.*, 21: 383-389.
- Hadadi A, Rasoulinejad M, Maleki Z, Mojtahedzadeh M, Younesian M, Ahmadi SA, Bagherian H, 2007. Antimicrobial resistance patterns among Gram-negative bacilli isolated from patients with nosocomial infections: Disk diffusion versus E-test. *Tehran Univ. Med. J.*, 65: 1-10.
- Ibargüen-Mondragón E, Gómez MC, Burbano-Rosero EM, 2021. Assessing the role of bacterial plasmid replication in a competition model of sensitive and resistant bacteria to antibiotics. *AIMS Mathematics*, 6 (9): 9446-9467.
- Ibargüen-Mondragón E, Romero-Leiton J, Esteva L, Gómez MC, Hidalgo-Bonilla SP, 2019. Stability and periodic solutions for a model of bacterial resistance to antibiotics caused by mutations and plasmids. *Applied mathematical modelling*, 76: 238-251.
- Joshi H, Yavuz M, 2023. Transition dynamics between a novel coinfection model of fractional-order for COVID-19 and tuberculosis via a treatment mechanism. *The European Physical Journal Plus*, 138(5): 468.
- MacVane SH, Kutı JL, Nicolau DP, 2014. Prolonging B-lactam infusion: A review of the rationale and evidence, and guidance for implementation. *Int. J. of Antimic. Ag.*, 43: 105-113.



- Majchrzak M, Zając E, Wawrzyszczak M, Filipiak A, Głuszek S, Adamus-Białek W, 2020. Mathematical Analysis of Induced Antibiotic Resistance Among Uropathogenic Escherichia coli Strains. *Microbial Drug Resistance*, 26 (10): 1236-1244.
- MathWorks, 2023. lsqcurvefit Fitting kinetic model to estimate kinetic parameter. <https://ch.mathworks.com/matlabcentral/answers/1990058-lsqcurvefit-fitting-kinetic-model-to-estimate-kinetic-parameter>. Accessed: 02/06/2024.
- Merdan M, Bekiryazici Z, Kesemen T, Khaniyev T, 2017. Comparison of stochastic and random models for bacterial resistance. *Advances in Difference Equations* 1: 1-19.
- Mondragón EI, Mosquera S, Cerón M, Burbano-Rosero EM, Hidalgo-Bonilla SP, Esteva L, Romero-Leitón JP, 2014. Mathematical modeling on bacterial resistance to multiple antibiotics caused by spontaneous mutations. *BioSystems*, 117: 60–67.
- Odibat ZM, 2010. Analytic study on linear systems of fractional differential equations. *Computers and Mathematics with Applications*, 59 (3): 1171-1183.
- Odibat ZM, Momani S, 2008. An algorithm for the numerical solution of differential equations of fractional order. *Journal of Applied Mathematics & Informatics*, 26(1): 15-27.
- Owolabi KM, 2018. Riemann-Liouville Fractional Derivative and Application to Model Chaotic Differential Equations. *Progr. Fract. Differ. Appl.*, 4 (2): 99-110.
- Öztürk İ, Daşbaşı B, Cebe G, 2019. A simple mathematical model through fractional-order differential equation for pathogenic infection. *Journal of Scientific Perspectives*, 3 (1): 29-40.
- Podlubny I, 1999. *Fractional Differential Equations*. Academic Press.
- Podlubny I, El-Sayed A, 1996. On Two Definitions of Fractional Calculus. Slovak Academy of Science, Institute of Experimental Phys.
- Razminia A, Majd VJ, Baleanu D, 2011. Chaotic incommensurate fractional order Rössler system: active control and synchronization. *Advance in Difference Equations*, 15: 1-12.
- Syed-Mohamed AF, 2013. *Pharmacokinetic and Pharmacodynamic Modeling of Antibiotics and Bacterial Drug Resistance*. Digital Comprehensive Summaries of Uppsala Dissertations from the Faculty of Pharmacy, 170.
- Yude JI, Jiyong LU, Jiqing QI, 2016. Stability of equilibrium points for incommensurate fractional-order nonlinear systems. *Proceedings of the 35th Chinese Control Conference July 27-29*, (s. 10453-10458). Chengdu, China.
- Zhang Y, 2009. Mechanisms of drug resistance in Mycobacterium tuberculosis. *International Journal of Tuberculosis and Lung Disease*, 13 (11): 1320–1330.

## Modeling Beef Production in Türkiye Using Narx Networks

Aslı AKILLI<sup>1\*</sup>, Suna AKKOL<sup>2</sup>

<sup>1</sup> 1Ankara Hacı Bayram Veli University, Faculty of Economics and Administrative Sciences,  
Department of Management Information Systems, 06500, Ankara, Türkiye

<sup>2</sup>Van Yüzüncü Yıl University, Faculty of Agriculture, Department of Animal Science, 65080, Van,  
Türkiye

\*Corresponding author e-mail: asli.akilli@hbv.edu.tr

### Abstract

*The optimization of agricultural production and the effective management of food supply are central to food security policies and significantly important for economic sustainability. Today, the agricultural production process is heavily influenced by rapidly changing market conditions and environmental factors, primarily climate change. The use of statistical forecasting methods plays a vital role in interpreting factors that affect red meat production—a strategic component of agricultural activities—and in accurately predicting production quantities, thereby facilitating resource management. In addition to traditional statistical methods, dynamic and flexible artificial intelligence-based models are extensively used in forecasting studies aimed at predicting agricultural data structures in a time series format. In this study, Nonlinear Autoregressive with Exogenous Inputs (NARX) networks are used to forecast beef production in Turkey. Meteorological data and past beef production quantities have been selected as input variables. The output variable has been identified as the beef production quantity for specific periods. The NARX model was trained using the time series data of these variables, and the model's success in production forecasts has been evaluated using statistical performance metrics. The results provide valuable insights for policymakers and sector managers in the critical agricultural and food sectors of the Turkish economy.*

**Keywords:** Beef Production, NARX networks, Neural Networks, Time Series.

### INTRODUCTION

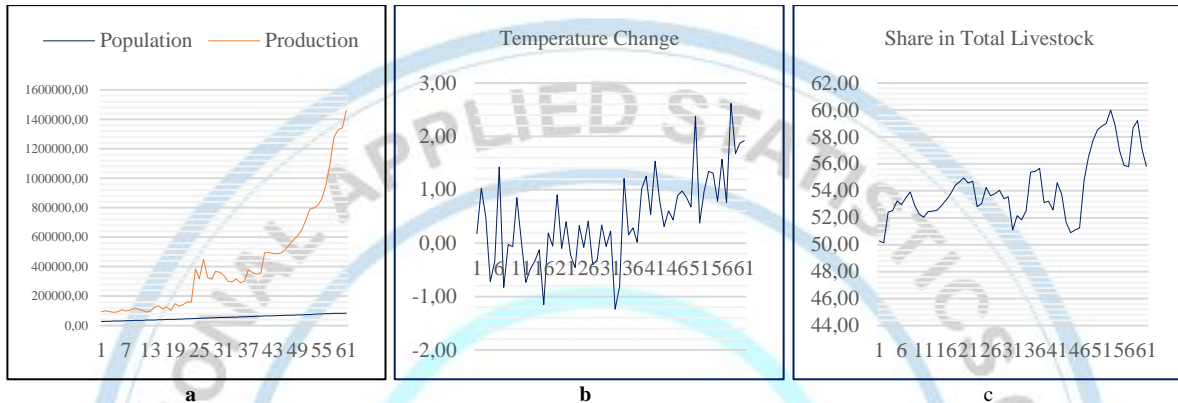
The primary objective of food security policies is to ensure that the population has ongoing access to adequate, safe, and nutritious food. Central to these policies is the optimization of agricultural production and the efficient management of food supplies, with the goal of enhancing production efficiency and ensuring sustainable resource use. The agricultural sector is pivotal not only for economic sustainability but also for its contributions to social welfare and health (Adeleja and George, 2021). It significantly aids in rural development, job creation, and poverty alleviation, underpinning a nation's long-term economic growth and development. Efficient agricultural processes are crucial as they reduce costs, enhance product competitiveness, and support environmental sustainability. Key factors include the efficient utilization of natural resources, soil fertility preservation, and sustainable water resource management. The precision of red meat production forecasts plays a crucial role in the success of agricultural operations. Inaccurate forecasts can cause severe economic and social issues, such as financial losses for producers due to overproduction or underproduction and high prices and shortages for consumers. Hence, reliable and accurate forecasts are vital for strategic planning and risk management in the agricultural sector (Hammer et al., 2001; De Pinto et al., 2021). The use of statistical forecasting methods plays a vital role in interpreting factors that affect red meat production—a strategic component of agricultural activities—and in accurately predicting production quantities, thereby facilitating resource management. In addition to traditional statistical methods, dynamic and flexible artificial intelligence-based models are extensively used in forecasting studies aimed at predicting agricultural data structures in a time series format. In this study, Nonlinear Autoregressive with Exogenous Inputs (NARX) networks are used to forecast beef production in Türkiye. The Nonlinear Autoregressive with Exogenous Inputs (NARX) model is a powerful tool frequently used in both time series analyses and predictive studies within the artificial neural networks' literature. The NARX model excels in predicting the behaviors of complex and nonlinear systems. It consists of two main components: past values (autoregressive) and external inputs (exogenous inputs). This model uses both

its own lagged values and the lagged values of external variables as inputs to predict future values. This feature endows the NARX model with the capacity to handle dynamic and multidimensional datasets. Compared to other traditional methods, the NARX model offers a more flexible and adaptable structure.

## MATERIAL AND METHODS

### Material

In this study, Nonlinear Autoregressive with Exogenous Inputs (NARX) networks are used to forecast beef production in Turkey. Meteorological data and past beef production quantities have been selected as input variables. The output variable has been identified as the beef production quantity for specific periods. The NARX model was trained using the time series data of these variables, and the model's success in production forecasts has been evaluated using statistical performance metrics.



**Figure 1.** (a) Change in Population and Production Values over Time, (b) Temperature Changes as Time Series, (c) Fluctuations in the Share in Total Livestock over Time

In Figure 1, three separate time series are presented in line graphs, each according to its content. The first graph compares population and production values over time. Visually, it is observed that production exhibits a rapid increase after a certain point, while the population shows a slower and more regular rise. The second graph depicts temperature changes over a specific period. Although the temperature changes fluctuate during certain periods, they generally follow an upward trend. The third graph shows the share of a particular category within the total livestock over time, clearly illustrating how this ratio fluctuates over time. These visual presentations are valuable for understanding the evolution of certain economic and environmental variables over time and the potential interactions between these changes.

Table 1 presents the descriptive statistics for various variables. Specifically, it includes the mean values, standard deviations, skewness, kurtosis, and the minimum and maximum values for variables such as temperature change, share in total livestock, population, and production variables. Temperature change has a mean value of 0.4501 (standard deviation  $\pm 0.8307$ ), displaying relatively low skewness (0.3286) and slight negative kurtosis (-0.015). This indicates that the data are distributed close to the mean and lack extreme values. The minimum and maximum values range between -1.24 and 2.62. Share in Total Livestock has a mean value of 54.192 (standard deviation  $\pm 2.3877$ ). This variable exhibits moderate skewness (0.735) and very slight negative kurtosis (-0.08). These results show a symmetric distribution near the mean but with the presence of outliers. The minimum and maximum values are 50.14 and 59.99, respectively. Population variable has a mean value of 55.534 (standard deviation  $\pm 17,088$ ). Also, this variable shows low skewness (0.0856) and high negative kurtosis (-1.214). These results reflect a wide distribution of data (minimum 28.255, maximum 84.775) with outliers primarily clustered at the lower end. Production variable, with a mean of 414.235 (standard deviation  $\pm 351.118$ ), has high skewness (1.4026) and high kurtosis (1.4712). This indicates a right-skewed distribution with a concentration of extreme values at higher ends. The minimum and maximum values are between 90.634 and 146.071.



**Table 1.** Descriptive statistics of variables

Parameters*	Mean±Std. Dev.	Skewness	Kurtosis	Minimum	Maximum
Temperature Change	0.4501±0.8307	0.3286	-0.015	-1.24	2.62
Share in Total Livestock	54.192±2.3877	0.735	-0.08	50.14	59.99
Population	55534±17088	0.0856	-1.214	28255	84775
Production	414235±351118	1.4026	1.4712	90634	146071

**Table 2.** Correlation coefficients of variables

Variables	Temperature Change	Share in Total Livestock	Population	Production
Temperature Change	.	0.405**	0.616**	0.660**
Share in Total Livestock	.	.	0.593**	0.598**
Population	.	.	.	0.963**
Production	.	.	.	.

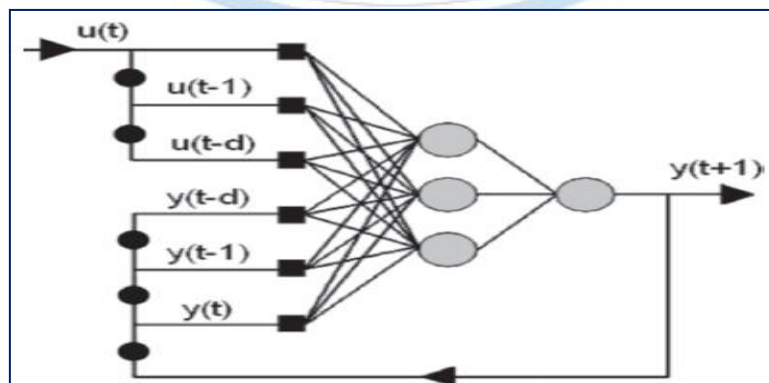
\*\*Statistically significant at 0.01 ( $p < 0.01$ )

Table 2 shows the statistical relationships among 'Temperature Change', 'Share in Total Livestock', 'Population', and 'Production'. 'Temperature Change' exhibits moderate to high positive correlations with 'Share in Total Livestock', 'Population', and 'Production' at 0.405, 0.616, and 0.660, respectively; these values indicate significant relationships between these variables. Similarly, 'Share in Total Livestock' also shows strong positive correlations with 'Population' and 'Production', at 0.593 and 0.598 respectively, suggesting robust associations between these variables. Particularly noteworthy is the correlation of 0.963 between 'Population' and 'Production', indicating an extremely strong linear relationship between these two variables.

## Methods

### NARX Network

Recurrent Neural Networks (RNNs) possess the capability to represent arbitrary nonlinear dynamical systems. The NARX (Nonlinear Autoregressive with Exogenous Inputs) recurrent networks bear a resemblance to the static architecture of Multilayer Perceptron (MLP) networks; however, they differentiate by the reintegration of the network output back into the input. Empirical evidence suggests that NARX recurrent neural networks are particularly effective in modeling nonlinear systems, including time series and diverse artificial nonlinear systems. Network with tapped delay lines.  $u(t)$  = input series;  $y(t)$  = output series, where  $d$  is the number of delays (Murphy et al., 2014). Figure 2 illustrates the structure of a NARX (Nonlinear Autoregressive with Exogenous Inputs) neural network. This diagram, labeled "NARX Neural Network Architecture," depicts a recurrent network structure that incorporates both past inputs ( $u(t)$ ,  $u(t-1)$ ,  $u(t-d)$ ) and outputs ( $y(t)$ ,  $y(t-1)$ ,  $y(t-d)$ ). The diagram serves to visually represent the training process of the neural network and the flow of information within it. In this architecture, which utilizes tapped delay lines,  $u(t)$  represents the input series and  $y(t)$  represents the output series, with  $d$  indicating the number of delays (Murphy et al., 2014).



**Figure 2.** NARX Neural Network Architecture (Murphy et al., 2014).

A NARX network can be implemented with a MultiLayer Perceptron (MLP), where the next value of the output signal  $y[t]$  is regressed on  $dy$  previous values of the output signal and on  $dx$  previous values of an independent, exogenous input signal  $x[t]$  (Lin et al., 1996; Xie et al., 2009). The Output Equation is given in Equation 1.

$$y[t]=\phi(x[t-d_x ],\dots, x[t-1],x[t],y[t-d_y ],\dots, y[t-1], \Theta \quad [1]$$

where  $\phi(\cdot)$  is the nonlinear mapping function performed by the MLP,  $\Theta$  are the trainable network parameters,  $dx$  and  $dy$  are the input and the output time delays. The input  $i[t]$  of the NARX network has  $dxNx+dyNy$  components which correspond to a set of two Tapped-Delay Lines. Mathematical representation is given in Equation 2.

$$i[t] = \begin{bmatrix} (x' [t - d_x], \dots x[t - 1]^T) \\ (y' [t - d_y], \dots y[t - 1]^T) \end{bmatrix}^T \quad [2]$$

These equations mathematically express how the network responds and processes information. This structure is utilized for modeling dynamic systems that consider both past inputs (exogenous inputs) and the network's previous outputs (autoregressive terms).

## RESULTS

The methodology section of the paper delineates the comprehensive approach undertaken for data preprocessing, model training, performance evaluation, and analysis of variable importance within the context of constructing a NARX model enhanced by Long Short-Term Memory (LSTM) layers. In data preprocessing phase, the initial dataset was procured from an Excel file, ensuring that the data was in a format suitable for further processing. Subsequently, the data underwent a normalization process utilizing the Min-Max scaling method to transform the data into a bounded range, which is a crucial step in preparing the data for neural network models. The dataset was then partitioned into training and testing sets, facilitating both the development and subsequent evaluation of the model. In model training phase, the training phase involved the construction of a NARX model, which incorporated LSTM layers to effectively capture the temporal dependencies characteristic of the dataset. The model architecture comprised two LSTM layers; the first layer consisted of 100 neurons, and the second contained 50 neurons. Training was executed using the Adamax optimizer, a variant of the Adam optimizer known for its robustness in scenarios with sparse gradients. To mitigate the risk of overfitting, an early stopping mechanism was implemented, halting training when the improvement in model performance plateaued. In performance evaluation phase, the efficiency of the model was assessed through a variety of performance metrics, including Mean Squared Error (MSE), Mean Absolute Error (MAE), Mean Absolute Percentage Error (MAPE), and R-Squared ( $R^2$ ). These metrics provided a comprehensive view of the model's predictive accuracy and the reliability of its outputs in comparison to the actual values. To elucidate the impact of individual input variables on the model's predictive performance, permutation importance analysis was conducted. This involved the random shuffling of values for each input variable and observing the resultant variations in model performance. This technique helped in identifying the relative contribution of each input variable to the accuracy of the model's predictions.

Two LSTM (Long Short-Term Memory) layers were used in the model. The first LSTM layer contains 100 neurons, while the second layer contains 50 neurons. Both layers incorporate Dropout. Dropout temporarily deactivates some neurons in the network, reducing the risk of overfitting and enhancing the model's generalization ability. The Adamax optimizer was employed during model training. Adamax is a variant of the Adam algorithm and can perform better with large and sparse gradients. In this study, the learning rate for the Adamax optimizer was set at 0.002. The number of epochs for model training was established at 300. However, to prevent overfitting, the EarlyStopping method was implemented. The patience parameter was set to 30, meaning that if there was no improvement in validation loss for 30 consecutive epochs, training would be halted, and the best weights would be restored.

**Table 3.** Statistical error criteria and equations

Statistical Error Criteria	Equations
Mean Square Error (MSE)	$MSE = \frac{1}{n} \sum_{i=1}^n (y_i - \hat{y}_i)^2$
Mean Absolute Percentage Error (MAPE)	$MAPE = \left(\frac{100}{n}\right) \sum_{i=1}^n \left  \frac{(y_i - \hat{y}_i)}{y_i} \right $
Adj.Coefficient of Determination ( $R^2$ )	$R_{Adj}^2 = 1 - (1 - R^2) \frac{(n-1)}{(n-p-1)}$

Where for the  $i^{th}$  record,  $\hat{y}_i$ : predicted value,  $y_i$ : actual value,  $n$ : number of records.

Three statistical error metrics used in predictive modeling were given in Table 3. Mean Square Error (MSE) measures the average squared differences between observed and predicted values, indicating model error variance. Mean Absolute Percentage Error (MAPE) calculates the average absolute percentage difference between observed and predicted values, offering a scale-independent accuracy measure. The Adjusted Coefficient of Determination (Adjusted  $R^2$ ) modifies the  $R^2$  value to account for the number of predictors, enhancing its accuracy in model comparison.

Table 4 presents prediction results obtained using various optimization algorithms applied to NARX (Nonlinear Autoregressive with Exogenous Inputs) neural networks, along with actual observation values. These results encompass the application of widely recognized algorithms such as Adam, SGD, RMSprop, Adagrad, Nadam, Adadelta, and Adamax. The implementation of these effective algorithms on NARX networks, particularly in variable and dynamic datasets, contributes to a detailed elucidation of findings and the achievement of successful prediction values.

**Table 4.** Actual and predicted values of algorithms

Actual	Adam	SGD	RMSprop	Adagrad	Nadam	Adadelta	Adamax
0.0030	-0.0698	-0.0699	-0.0600	0.1790	-0.0198	0.0070	-0.0050
0.0114	0.0785	0.0856	0.0958	0.2139	0.0799	0.1083	0.0926
0.3349	0.4161	0.3976	0.4321	0.2760	0.4515	0.4406	0.4191
0.1532	0.0885	0.0670	0.0816	0.2104	0.0731	0.0844	0.0801
0.0249	0.0192	-0.0068	0.0141	0.1974	0.0120	0.0120	0.0227
0.6317	0.5834	0.5481	0.6023	0.3046	0.6726	0.6289	0.6232
0.1473	0.2707	0.2580	0.2732	0.2495	0.2638	0.2598	0.2488
0.4061	0.6695	0.6246	0.6818	0.3192	0.7811	0.7160	0.7231
0.0054	0.0035	-0.0255	-0.0041	0.1935	0.0007	0.0074	0.0109
0.2942	0.4040	0.3895	0.4221	0.2745	0.4412	0.4302	0.4083
0.1649	0.2654	0.2579	0.2864	0.2492	0.2847	0.2718	0.2674
0.9129	0.6830	0.6330	0.7011	0.3203	0.8119	0.7340	0.7533
0.0266	0.0932	0.0813	0.0959	0.2151	0.0809	0.0676	0.0874

These findings can serve as a crucial guide for algorithm selection in areas such as time series forecasting and modeling of complex dynamic systems. The correct choice of optimization algorithm significantly enhances the predictive accuracy of the model, representing a critical decision point for data scientists and researchers. Figure 3 and Figure 4 show actual and predicted values by different algorithms and error distribution of different algorithms, respectively.



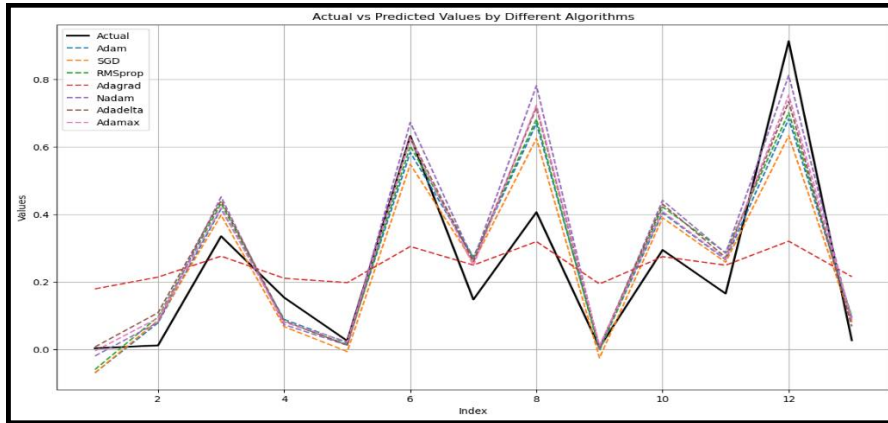


Figure 3. Actual and predicted values by different algorithms.

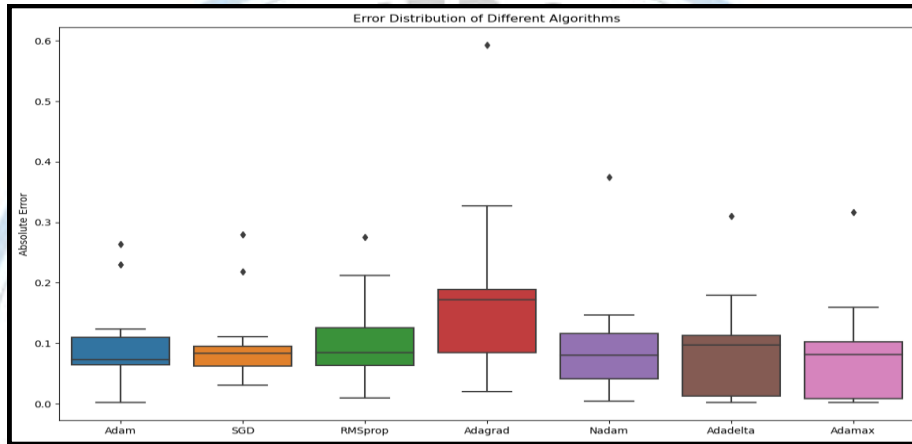


Figure 4. Error distribution of different algorithms.

The results presented in Table 5 provide a comparative analysis of several optimization algorithms applied to a predictive modeling task, utilizing metrics such as Mean Squared Error (MSE), Mean Absolute Error (MAE), Mean Absolute Percentage Error (MAPE), and the coefficient of determination ( $R^2$ ). The Adam and Adamax algorithms exhibited superior performance across these metrics. Specifically, Adamax demonstrated a high degree of accuracy, recording the lowest MSE (0.0141) and MAE (0.0860), along with a strong  $R^2$  value of 0.8021, thereby underscoring its effectiveness in modeling with minimal prediction errors and a robust fit to the data. In contrast, Adagrad significantly underperformed, showing the highest MSE, MAE, and MAPE, which indicates its unsuitability for this dataset. These findings highlight the critical importance of algorithm selection in achieving optimal predictive performance, with Adamax and Adadelta proving to be particularly effective for this specific task.

Table 5. Statistical performance values of algorithms

Algorithm	MSE	MAE	MAPE	$R^2$
Adam	0.0141	0.0932	277.9683%	0.8021
SGD	0.0146	0.0995	331.0961%	0.7940
RMSprop	0.0153	0.0998	282.9322%	0.7840
Adagrad	0.0510	0.1736	984.7903%	0.2815
Nadam	0.0177	0.0969	161.2326%	0.7504
Adadelta	0.0152	0.0906	121.4239%	0.7857
Adamax	0.0141	0.0860	127.1272%	0.8021

Table 6 shows the permutation importance scores illustrate the varying degrees of relevance that these factors have within the NARX network, highlighting the complexity and multidimensional structure of factors affecting agricultural predictions. The results underscore the necessity of considering both direct and indirect influences in agricultural forecasting models, with a significant emphasis on temporal changes as reflected by the importance of the 'Year' variable.

**Table 6.** Results of permutation importance analysis.

Variable	Permutation Importance
Year	0.0291
Temperature Change	0.0072
Share in Total Livestock	-0.0007
Population	0.0016

## CONCLUSION

This study demonstrates that the NARX model is an effective tool for assessing the impact of input variables on the dependent variable. By employing the permutation importance method, the contribution of each input variable to model performance was scientifically quantified. This approach is useful for identifying key variables in complex time series data and enhancing model efficiency. The results indicated that the utility of dynamic and adaptable models like NARX networks for forecasting beef production in Turkey, pinpointing the year and the share in total livestock as the most influential input variables for predicting beef production quantities. By incorporating these significant factors, the NARX model provides a robust framework for predicting production trends and optimizing resource management. The insights from this research offer valuable guidance for policymakers and stakeholders in the Turkish agricultural sector, supporting strategic planning and decision-making to promote economic sustainability and food security.

## References

- Adelaja, A., & George, J. (2021). Food and Agricultural Security: An Introduction to the Special Issue. *Sustainability*, 13(21), 12129.
- De Pinto, A., Cenacchi, N., Kwon, H. Y., Koo, J., & Dunston, S. (2020). Climate smart agriculture and global food-crop production. *PLoS One*, 15(4), e0231764.
- Hammer, G. L., Hansen, J. W., Phillips, J. G., Mjelde, J. W., Hill, H., Love, A., & Potgieter, A. (2001). Advances in application of climate prediction in agriculture. *Agricultural systems*, 70(2-3), 515-553.
- Lin, T., Horne, B. G., Tino, P., & Giles, C. L. (1996). Learning long-term dependencies in NARX recurrent neural networks. *IEEE transactions on neural networks*, 7(6), 1329-1338.
- Murphy, M. D., O'Mahony, M. J., Shalloo, L., French, P., & Upton, J. (2014). Comparison of modelling techniques for milk-production forecasting. *Journal of dairy science*, 97(6), 3352-3363.
- Xie, H., Tang, H., & Liao, Y. H. (2009, July). Time series prediction based on NARX neural networks: An advanced approach. In 2009 International conference on machine learning and cybernetics (Vol. 3, pp. 1275-1279). IEEE.

## Conflict of Interest

There is no conflict of interest".

## Author Contributions

Contributions of the authors are equal.

## Analysis of Small Ruminant Farms in Van Province Using Fuzzy Clustering Analysis

Suna AKKOL<sup>1</sup>, Aslı AKILLI<sup>2\*</sup>

<sup>1</sup>Van Yüzüncü Yıl University, Faculty of Agriculture, Department of Animal Science, 65080, Van, Türkiye.

<sup>2</sup>Ankara Hacı Bayram Veli University, Faculty of Economics and Administrative Sciences, Department of Management Information Systems, 06500, Ankara, Türkiye.

\*Corresponding author e-mail: asli.akilli@hbv.edu.tr

### Abstract

*This study evaluates small ruminant farming enterprises in Van Province using fuzzy clustering analysis, based on a comprehensive range of parameters including the demographic characteristics of the farm owners, livestock assets, breed and quantity information, geographic locations, health and veterinary services, farm management, animal care and feeding practices, and production periods. The aim of this research is to identify the structural and operational characteristics of regional small ruminant farms and to contribute positively to strategic recommendations for sustainable development. In recent years, fuzzy clustering analysis—a method based on fuzzy logic—has become increasingly popular in the field of animal husbandry. Compared to traditional clustering methods, fuzzy clustering offers more flexible grouping and more detailed analysis opportunities. This method is particularly effective in heterogeneous data sets, as it defines membership degrees, thereby more clearly revealing the differences both between and within enterprises. The analyses performed using the Principal Component-based Fuzzy C-Means algorithm have utilized validity criteria to determine the optimum number of clusters. The results show that small ruminant farms in Van Province have been successfully grouped according to various factors, facilitating a better understanding and management of these enterprises.*

**Keywords:** Fuzzy Clustering, Fuzzy C-Means, Small Ruminant.

### INTRODUCTION

Small ruminant farming constitutes a vital component of agricultural systems worldwide, particularly in regions where climate and geographical conditions are suitable for sheep and goat husbandry. In such regions, the economic, cultural, and social importance of small ruminants is significant, contributing to livelihoods, food security, and rural economies. In Türkiye, Van Province represents a crucial area for small ruminant farming due to its favorable environmental conditions and the historical prevalence of these practices. The application of advanced analytical methods, such as fuzzy clustering analysis, has garnered attention in agricultural research by providing nuanced insights into complex and heterogeneous datasets. Although traditional clustering methods are widely used, they often fall short in addressing the inherent variability and overlap present in agricultural data. Fuzzy clustering, based on the principles of fuzzy logic, allows for the assignment of membership degrees to data points, thereby providing a more flexible and detailed classification system. This approach has been effectively utilized in various fields, including livestock farming, to better understand the fundamental structures and operational characteristics of farming enterprises. Recent studies have demonstrated the effectiveness of fuzzy clustering in agricultural research. For example, while McBratney and Moore (1985) emphasize the advantages of fuzzy clustering in climatic data classification, Bezdek et al. (1984) demonstrated its application in pattern recognition on geostatistical data analysis. In the context of animal husbandry, Skjerve et al. (2024) used density-based clustering with noise and Fuzzy C-Means algorithms to edit and group a large, noisy dataset from a livestock herd recording scheme, which consisted of slaughter records on 73,743 bulls. When examining the relevant studies in the literature, it is observed that fuzzy clustering analysis has significant potential to increase the level of detail and accuracy in agricultural data analysis. It also contributes positively to informed decision-making and strategic planning.

In this study, we applied the Principal Component-Based Fuzzy C-Means (PCA-FCM) algorithm to evaluate small ruminant farms in Van Province. This method combines the dimensionality reduction capabilities of Principal Component Analysis (PCA) with the flexible clustering framework of Fuzzy



C-Means, providing a robust and comprehensive analysis of the farms. This study integrates various parameters such as the demographic characteristics of farm owners, livestock assets, breed and quantity information, geographical locations, health and veterinary services, farm management practices, and production periods. It aims to illuminate the structural and operational dynamics of small ruminant farming in Van. The findings are intended to contribute to the formulation of strategic recommendations that support the sustainable development and resilience of the small ruminant sector in the region.

## MATERIAL AND METHODS

### Material

This study evaluates small ruminant farming enterprises in Van Province using fuzzy clustering analysis, based on a comprehensive range of parameters including the demographic characteristics of the farm owners, livestock assets, breed and quantity information, geographic locations, health and veterinary services, farm management, animal care and feeding practices, and production periods. The data were obtained through a comprehensive survey study performed at regional level involving 434 farmers.

### Methods

#### *Fuzzy Clustering*

Data clustering is a crucial analytical technique in data science, used to group objects into clusters such that objects within the same cluster (or group) are more similar to each other than to those in other clusters. The importance of data clustering lies in its ability to simplify large datasets, facilitating the understanding and interpretation of underlying trends, relationships, and distributions. Effective clustering can provide a clearer view of the data environment, aiding decision-making processes, improving predictive models, and supporting strategic planning (Jain and Dubes, 1988).

Fuzzy clustering is a data clustering technique where each data point belongs to a cluster to a certain degree, as determined by a membership degree (Diaz et al., 2006; Görgülü, 2010). Fuzzy C-Means (FCM) was first introduced by Jim Bezdek in 1981 as an improvement over previous clustering method. It provides a method for grouping data points that populate a multidimensional space into a specified number of distinct clusters (Bezdek, 1981). FCM is an advanced clustering algorithm that extends the traditional K-means method by incorporating principles of fuzzy logic. Unlike hard clustering methods, where each data point belongs to a single cluster, FCM allows each data point to belong to multiple clusters with a certain degree of membership, represented by a membership function. This flexibility enables FCM to handle overlapping clusters more effectively, providing a more nuanced understanding of the data set. The algorithm iteratively updates the cluster centers and the membership degrees of the data points by minimizing an objective function, typically measuring the total variance within clusters, until convergence is achieved. FCM is particularly advantageous in scenarios involving heterogeneous data, as it can more accurately reflect the complexities and uncertainties inherent in real-world data sets. By doing so, it leads to more robust and insightful clustering results. The iterative process of FCM ensures that data points are assigned to clusters in a way that captures the underlying patterns and structures in the data, making it a powerful tool for data analysis and interpretation.

FCM is an iterative process that terminates when a specific stopping criterion is met. This criterion is satisfied either when the maximum number of iterations is reached or when the difference between successive values of the objective function, as defined in Equation 1, is less than a predetermined convergence threshold ( $\epsilon$ ). In the Fuzzy C-Means method, the minimization of the objective function is performed to achieve optimal clustering results.

$$\text{Minimize } J_m(U, V) = \sum_{k=1}^n \sum_{i=1}^c u_{ki}^m \|x_k - v_i\|^2 \quad [1]$$

The components of the objective function in Equation 1 are summarized as follows: Where  $n$  is the total number of data vectors in data set and  $c$  is the number of clusters.  $X = \{x_1, x_2, \dots, x_n\} \subset \mathbb{R}^S$  is the feature data,  $V = \{v_1, v_2, \dots, v_n\} \subset \mathbb{R}^S$  is cluster centers; and  $U = (u_{ki})_{n \times c}$  is a fuzzy partition matrix composed of the membership of each feature vector  $x_k$  in each cluster.  $u_{ki}$  should satisfy  $\sum_{i=1}^c u_{ki} = 1$  for  $k = 1, 2, \dots, n$  and  $u_{ki} \geq 0$  for all  $i = 1, 2, \dots, c$ . The exponent  $m > 1$  in  $J_m(U, V)$  is a parameter, usually called a fuzzifier.

The following steps are followed in Fuzzy C-Means clustering analysis (Sun et al., 2004):

1. Input the number of clusters  $c$ , the fuzzifier  $m$  and the distance  $\| \cdot \|$ .
2. Initialize the cluster centers,  $v_i^0 (i = 1, 2, \dots, c)$ .
3. Calculate membership values  $u_{ki}$  (Equation 2),

$$u_{ki}^m = \frac{1}{\sum_{j=1}^c \left( \frac{\|x_k - v_j\|^2}{\|x_k - v_i\|^2} \right)^{\frac{1}{m-1}}}, \quad \|x_k - v_j\| > 0 \quad [2]$$

4. Calculate prototype vectors  $v_i$  (Equation 3):

$$v_i = \frac{\sum_{k=1}^n u_{ki}^m x_k}{\sum_{k=1}^n u_{ki}^m}, \quad i = 1, 2, \dots, c. \quad [3]$$

5. If  $\max_{1 \leq i \leq c} (\|v_i^0 - v_i^1\| / \|v_i^1\|) \leq \varepsilon$  then go to Step 6; else let  $v_i^0 = v_i^1 (i = 1, 2, \dots, c)$  and go to Step 3.
6. Output the clustering results (Cluster centers, membership matrix and the elements of each cluster).
7. Stop.

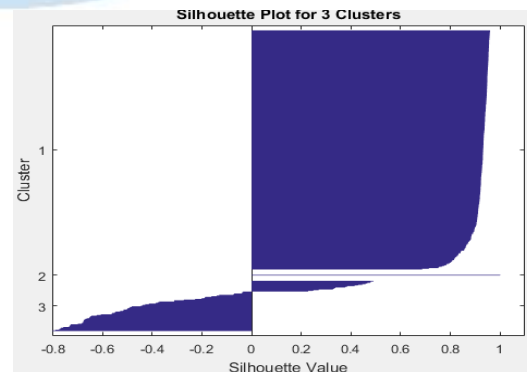
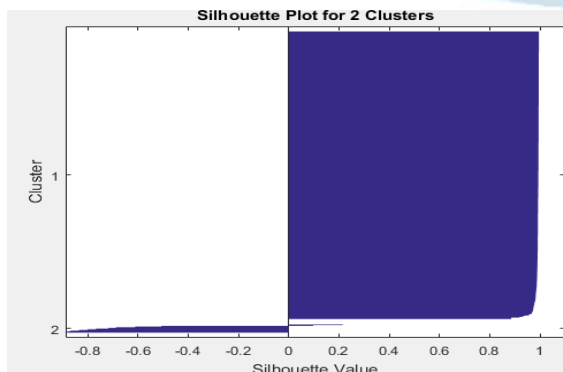
Steps are repeated until the objective function improves less than the specified minimum threshold or until the specified maximum number of iterations (Sun et al., 2004; Doğruparmak et al., 2014; Cebeci and Yildiz, 2015). Analyzes were carried out using MATLAB R2016a and SPSS 29.0 statistical package programs.

## RESULTS

The first part of the research findings consists of the results of principal component-based fuzzy clustering analysis. In the other part of the findings, the results of comparing the clusters obtained by fuzzy clustering with non-parametric tests are included.

**Table 1.** Mean silhouette values and Dunn index values of clusters.

Number of Clusters	Mean Silhouette Coefficient	Dunn Index	Comments
2	0.94613	0.0059	Very high mean Silhouette coefficient, but low Dunn index. Good within-cluster cohesion, weak between-cluster separation.
3	0.70779	0.0151	Good mean Silhouette coefficient, moderate Dunn index. Good within-cluster cohesion, better between-cluster separation.
4	0.49701	0.0086	Moderate mean Silhouette coefficient, low Dunn index. Weak cluster separation.
5	0.45735	0.0088	Lowest mean Silhouette coefficient and low Dunn index. Weak within-cluster cohesion, weak between-cluster separation.



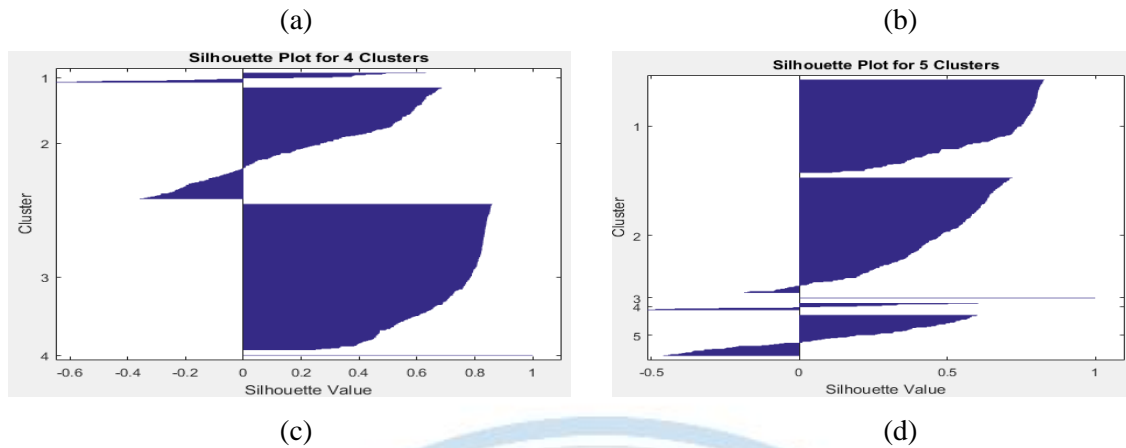


Figure 1. Silhouette plots of clusters.

Table 2. Kruskal Wallis H results of producer clusters determined by Fuzzy C-Mean Clustering

Variables $\bar{x} \pm s_x$ (Mean Rank)	Cluster1	Cluster2	Cluster3	Kruskall Wallis H	Sig.
Ewe	90.19±15.38 (190.77)	98.14±9.330 (220.8)	99.83±6.545 (252.45)	19.472	<.001*
Ram	6.102±0.827 (230.89)	2.757±0.349 (150.71)	5.179±0.397 (247.64)	39.887	<.001*
Nanny (Goat)	5.168±0.670 (140.71)	22.05±1.736 (293.04)	17.78±1.312 (270.14)	141.111	<.001*
Billy (Goat)	0.540±0.080 (169.66)	1.203±0.190 (220.56)	2.104±0.209 (283.5)	76.679	<.001*
Duration of Grazing on Pasture	3.510±0.126 (210.07)	3.427±0.122 (202.87)	4.246±0.235 (238)	5.894	0.05
Duration of Stay on the Plateau	3.882±0.146 (205.74)	5.796±0.166 (316.89)	2.753±0.213 (156.69)	100.517	<.001*
Duration of Stay in the Barn	4.392±0.082 (234.34)	2.427±0.132 (91.93)	4.903±0.114 (287.77)	158.822	<.001*
Duration of Ram's Presence in the Flock	1.515±0.038 (212.43)	1.019±0.013 (103.67)	1.985±0.010 (310.8)	214.126	<.001*
Number of Lambs	50.32±3.373 (175.12)	96.53±9.992 (261.28)	64.55±2.938 (244.22)	41.229	<.001*
Number of Kids	3.765±0.508 (142.7)	26.54±2.417 (280.6)	16.17±1.002 (276.79)	136.458	<.001*
Number of Dead Lambs	4.642±0.475 (171.4)	14.30±1.148 (332.7)	4.544±0.386 (194.77)	119.48	<.001*
Number of Dead Kids	0.699±0.134 (144.03)	3.922±0.314 (313.32)	2.014±0.176 (249.7)	152.645	<.001*

In fuzzy clustering analysis, clustering success of objects is determined by Silhouette coefficient  $s(i)$ .  $s(i)$  indicates how well the  $i$ th object is clustered and takes a value between  $-1 < s(i) < 1$ . In our study, the optimal number of clusters was determined by evaluating the performance metrics of different clustering scenarios. The two-cluster scenario exhibited the highest mean Silhouette coefficient, indicating that



observations were well-assigned to their respective clusters. However, this scenario also showed a low Dunn index, suggesting weak separation between the clusters. Conversely, the three-cluster scenario achieved a mean Silhouette coefficient of 0.70779 and a Dunn index of 0.015191, indicating good inter-cluster separation. The four and five-cluster scenarios displayed lower mean Silhouette coefficients and low Dunn indices, reflecting weak separation and suboptimal clustering performance. Therefore, the analysis results demonstrate that the three-cluster configuration yields more successful clustering outcomes for optimal cluster analysis. Analysis results are included in Table 1.

As the number of clusters increases, it becomes difficult to distinguish some clusters from each other and negative silhouette values may increase. Evaluations show that scenarios with two or three clusters provide better results, with these configurations generally having higher silhouette values and better definition of the separation between clusters. When the general situation of silhouette drawings is analyzed, it is seen that the most effective separation is achieved with two or three clusters. On the other hand, it has been determined that in structures with four and five clusters, uncertainty and the possibility of incorrect cluster assignment tend to increase and therefore clustering performance may be negatively affected.

The Kruskal-Wallis H results for producer clusters determined by Fuzzy C-Means Clustering are presented in Table 2, specifically for variables related to animal assets. Other variables used in the fuzzy cluster analysis were not included in the Kruskal-Wallis analysis because they have categorical structures. In this study, the comparison of means among three different clusters in terms of variables related to livestock presence and the investigation of whether there is a significant difference between groups were conducted using the Kruskal-Wallis H test. A statistically significant relationship was found between the cluster means for all variables except for the Duration of Grazing on Pasture ( $p < 0.01$ ). The results of the non-parametric multiple comparison test indicated that the differences between the groups could be attributed to the second cluster.

## CONCLUSION

This study aimed to evaluate small ruminant farming enterprises in Van Province using fuzzy clustering analysis, based on a comprehensive range of parameters. These parameters included the demographic characteristics of farm owners, livestock assets, breed and quantity information, geographic locations, health and veterinary services, farm management, animal care and feeding practices, and production periods. The Principal Component-based Fuzzy C-Means algorithm was employed, utilizing validity criteria to determine the optimal number of clusters. The analysis revealed that the three-cluster configuration provided the most effective separation, as indicated by the highest Dunn Index value. This configuration allowed for a clear distinction between different types of small ruminant farms. The findings demonstrate the usability of fuzzy clustering analysis in managing heterogeneous data sets and identifying nuanced differences within the farming sector. In conclusion, the application of fuzzy clustering analysis has proven to be highly effective in classifying small ruminant farms in Van Province. The insights gained from this study can aid in developing strategic initiatives that support the growth and sustainability of small ruminant farming. Future research could build on these findings by exploring the application of fuzzy clustering to other regions and agricultural sectors, further demonstrating its versatility and value in agricultural research and development.

## References

- McBratney, A. B., & Moore, A. W. (1985). Application of fuzzy sets to climatic classification. *Agricultural and forest meteorology*, 35(1-4), 165-185.
- Bezdek, J. C., Ehrlich, R., & Full, W. (1984). FCM: The fuzzy c-means clustering algorithm. *Computers & geosciences*, 10(2-3), 191-203.
- Skjerve, T. A., Klemetsdal, G., Åby, B. A., Sommerseth, J. K., Indahl, U. G., & Olsen, H. F. (2024). Using Density and Fuzzy Clustering for Data Cleaning and Segmental Description of Livestock Data. *Journal of Agricultural, Biological and Environmental Statistics*, 1-16.
- Jain, A. K., & Dubes, R. C. (1988). *Algorithms for clustering data*. Prentice-Hall, Inc.
- Díaz, B., Moniche, L., & Morillas, A. (2006). A fuzzy clustering approach to the key sectors of the Spanish economy. *Economic Systems Research*, 18(3), 299-318.
- Gorgulu O (2010) Classification of dairy cattle in terms of some milk yield characteristics using by

- fuzzy clustering. *J Animal Veterinary Advances* 9(14): eNo.: 1947–1951.
- Sun, H., Wang, S., & Jiang, Q. (2004). FCM-based model selection algorithms for determining the number of clusters. *Pattern recognition*, 37(10), 2027-2037.
- Dogruparmak, S. C., Keskin, G. A., Yaman, S., & Alkan, A. (2014). Using principal component analysis and fuzzy c-means clustering for the assessment of air quality monitoring. *Atmospheric Pollution Research*, 5(4), 656-663.
- Cebeci, Z., & Yildiz, F. (2015). Comparison of k-means and fuzzy c-means algorithms on different cluster structures. *Journal of Agricultural Informatics*, 6(3).

**Conflict of Interest**

There is no conflict of interest.

**Author Contributions**

Contributions of the authors are equal.



## An Evaluation of XAI Methods for Object Detection in Satellite Images using YOLOv5

Uğur ÖZENC\*, Alp ERTÜRK

Kocaeli University, Electronics and Telecommunication Eng. Dept., Kocaeli, Türkiye

Corresponding author e-mail: ugur.ozenc@yahoo.com, alp.erturk@kocaeli.edu.tr

### Abstract

*In recent years, deep learning based approaches have gained widespread adoption in Earth observation and remote sensing, mirroring their success in numerous other domains. However, unlike approaches based on physical models, deep learning methods operate as black boxes, concealing internal processes influencing final decisions. This lack of transparency poses a challenge, particularly in applications where interpretability is paramount, as outputs generated by these approaches cannot be fully trusted or verified. Explainable Artificial Intelligence (XAI) aims to make the deep learning processes and their outputs more interpretable for researchers and end users. The purpose of this study is to investigate and evaluate the performance of various XAI methodologies for post-hoc explainability of object detection in satellite images using deep learning. Class-activation mapping (CAM) based XAI methods, namely GradCAM, GradCAM++, EigenCAM, ScoreCAM, and LayerCAM, are used for post-hoc explainability, following target detection by You Look Only Once (YOLO) algorithm. Experimental results show that each method provides considerably different saliency maps, which may be used for qualitative performance analysis of the interpretability provided by these methods. However, in a large dataset, a qualitative analysis by itself may be subjective and misleading. As such, an evaluation framework tailored for remote sensing applications is adopted to evaluate the interpretability performances of these XAI methods quantitatively. The findings provide an important step towards understanding the role and effectiveness of these XAI methods for interpretability of object detection for remote sensing.*

**Keywords:** Class Activation Mapping (CAM), Deep Learning, Explainable Artificial Intelligence (XAI), Object Detection, Remote Sensing

### INTRODUCTION

Remote sensing data play a crucial role in various critical applications, including environmental monitoring, disaster response, infrastructure management, and national security. One of the tasks central to these applications is object, or target, detection, which involves identifying and localizing specific objects or features of interest, such as buildings, ships, and military vehicles.

The recent increase in the number of remote sensing satellites, coupled with open data policies, have resulted in an increase in readily available remote sensing data and extensive repositories. Deep learning, particularly convolutional neural networks (CNNs), has revolutionized many data processing tasks in remote sensing, including object detection, by leveraging these large volumes of data to extract meaningful information from these data and train highly accurate models, surpassing the limits of traditional techniques. R-CNN [1], Faster R-CNN [2] and You Look Only Once (YOLO) [3] are some of the CNN based algorithms that have provided remarkable performances in detecting targets in remote sensing images.

However, unlike approaches based on physical models, deep learning methods operate as “black boxes”, concealing internal processes or factors influencing final decisions. The “black-box” nature of deep learning models often leaves end-users, including analysts and decision-makers, uncertain about the reliability of and reasoning behind the outputs of these algorithms. Explainable Artificial Intelligence (XAI) refers to a series of approaches and methods that aim to make deep learning and other artificial intelligence approaches more transparent and/or interpretable for humans. Various committees have prepared regulations emphasizing that AI approaches should be explainable and adhere to principles of “Fairness,” “Accountability,” and “Transparency.” Some of these regulations include the EU’s Ethics Guidelines for Trustworthy AI and Microsoft’s FATE: Fairness, Accountability, Transparency, and Ethics in AI. Within the framework of the European Union General Data Protection Regulation (GDPR), explainability is considered a legal right. Explainability is fast becoming a requirement in various fields



such as data-driven medical diagnosis, insurance risk assessment, and autonomous vehicles. In the field of remote sensing, XAI has started to find usage only in recent years, but its prevalence and importance is quickly increasing [4-5]. In the realm of target detection in remote sensing images, XAI methods may be used to clarify why a model identifies certain targets, highlight the features it deems most significant, and uncover potential biases or errors within the model.

However, the number of studies on the use of XAI for object detection in remote sensing is currently limited. In [6], salient data points are visualized with Gradient Class Activation Mapping (Grad-CAM) [7] in UAV data for target detection using YOLOv5. In [8], saliency maps of input data are generated using Grad-CAM++ [9], and these maps are used to enhance the detection performance of the YOLOv3 approach by masking salient points and focusing training on other points. In [10], MultiCAM is proposed and used to detect discriminative points and suppress background interference in the target detection network. In [11], KernelSHAP, a version of SHapley Additive exPlanations (SHAP) [12], is used to generate saliency maps in superpixels and to induce a bias in the data. In [13], GradientSHAP is used for feature evaluation in target detection with YOLOv3. In [14], a polarization attention module is used to obtain feature pyramids and improve target detection performance with these feature pyramids. In [15], a causal multi-attention module and filter stacking module are used to improve performance in fine-grained classification. As can be seen, most, if not all, related works in the remote sensing object detection literature utilize a single XAI methodology, with the aim of either pos-hoc interpretability, or improving the detection performance based on XAI.

This paper investigates the integration of various CAM-based XAI techniques with a state-of-the-art target detection algorithm, YOLOv5, for remote sensing images. Integrating XAI methods allows maintaining high detection performance while delivering more interpretable and comprehensible results. Grad-CAM [7], Grad-CAM++ [9], EigenCAM [16], ScoreCam [17], and LayerCAM [18] are the utilized and analyzed XAI methods in this paper. The interpretability provided by the utilized XAI methods are not only compared qualitatively through visual analysis of their saliency maps, but also quantitatively with an evaluation framework tailored for remote sensing applications. This framework involves masking out either the highlighted or unhighlighted parts of the data based on a thresholding of each XAI method's saliency map, and evaluating the decrease in the object detection performance. Empirical results show that there are significant differences between the saliency maps provided by each CAM method, and highlight which method works best for object detection in remote sensing. The provided analysis has the potential to not only improve the usability of target detection systems, but also empowers analysts and decision-makers to make more informed judgments based on the AI model's output.

## MATERIAL AND METHODS

This section outlines the methodology used in this study, focusing on the integration of YOLO (v5) for target detection and various CAM-based XAI methods for post-hoc interpretability. Also provided in this section is the framework used for the performance evaluation and comparison of the utilized XAI methods.

### You Look Only Once (YOLO)

YOLO is a deep learning approach known for its speed and accuracy in object detection. YOLO does not operate in a region-based manner like its predecessors R-CNN and Faster R-CNN, and instead processes input data in a single pass, which is the primary reason for its speed. YOLO divides input data into grids, with the grid cells varying in size depending on the image dimensions and the size of the objects. Each cell in the grid extracts a set of features to predict whether objects are present in that region. These cells produce outputs to detect the position of the objects and the presence of a certain number of classes. For each cell, the algorithm attempts to predict the probability of the class and the coordinates of the bounding box.

In this work, YOLO v5 is used, which builds on the strengths of its predecessors with several improvements. YOLO v5 uses a CSPDarknet53 backbone in order to extract rich features from input images, and the cross stage partial network enhances the learning capability and efficiency by partitioning the feature maps and merging them through a cross-stage hierarchy. The path aggregation

network is employed as the neck to enhance information flow and improve localization and classification performance by combining features from different layers. YOLO v5 employs a loss function that is a combination of three components: localization loss, confidence loss, and classification loss.

### CAM-Based Methods for Explainability

The XAI methods utilized in this work are CAM-based methods, which may be used to visualize the regions of an image that are important for a CNN based network's, in this case YOLO v5's, prediction. These methods highlight the spatial regions in the input image that the model focuses on to make a decision, providing insights into the model's reasoning process.

#### Grad-CAM:

Grad-CAM (Gradient-weighted Class Activation Mapping) generates visual explanations for CNN-based models by leveraging the gradient information,  $y^c$ , for any class  $c$ , flowing into the final convolutional layer preceding the final softmax layer, of the network. The backpropagated gradients are combined using globally average pooling to obtain a set of neuron importance weights,  $\alpha_c^k$ , as shown below.

$$\alpha_c^k = \frac{1}{Z} \sum_i \sum_j \frac{\partial y^c}{\partial A_{ij}^k} \quad (1)$$

Multiplying the weights with the corresponding feature maps provides heatmaps that highlights important regions relevant to the target class prediction in the input data. Class-discriminative localization maps, i.e. heatmaps,  $L_{\text{Grad-CAM}}^c$ , are finalized after a ReLU operation, applied to emphasize only the features that have a positive effect on the prediction of the class  $c$ .

$$L_{\text{Grad-CAM}}^c = \text{ReLU}(\sum_k \alpha_k^c A^k) \quad (2)$$

#### Grad-CAM++:

Grad-CAM has two reported shortcomings. One is that if an image contains multiple instances of the same object, it may fail to accurately highlight each [19]. Additionally, the heatmaps provided by Grad-CAM are rather coarse. Grad-CAM++ was introduced to address the above limitations of Grad-CAM. Grad-CAM++ improves upon Grad-CAM by providing better localization and handling multiple occurrences of the same class in an image. It uses higher-order derivatives to weigh the importance of pixels more precisely, resulting in finer and more accurate heatmaps. The weights in Grad-CAM++ and the heatmaps are obtained as follows.

$$\alpha_c^k = \sum_i \sum_j \frac{\partial y^c}{\partial A_{ij}^k} \frac{\partial^2 y^c}{\partial (A_{ij}^k)^2} \quad (3)$$

$$L_{\text{Grad-CAM}^{++}}^c = \text{ReLU}(\sum_k \alpha_k^c A^k) \quad (4)$$

#### Eigen-CAM:

Eigen-CAM uses principal component analysis (PCA), instead of gradient backpropagation, in order to generate the class activation maps. Not relying on gradients allows avoiding potential issues related to gradient saturation and/or noisy gradients. In Eigen-CAM, feature maps extracted from the CNN-based network are used as inputs to PCA in order to identify the eigenvectors corresponding to the highest variances.

$$L_{\text{Eigen-CAM}} = \text{PCA}(A^k) \quad (5)$$

#### Score-CAM:

Score-CAM is another XAI method that aims to overcome the potential drawbacks of using gradients. Score-CAM generates the class activation maps based on the actual class scores rather than gradient information. The weight of each class activation map is obtained through the forward pass score on target classes. A mask is created for each feature map extracted from the network by upsampling it to the size of the input data. Masked images are passed through the network to obtain the class scores, as follows.

$$S_k = f(x \odot \text{mask}(A^k)) \quad (6)$$

The importance weights are computed by normalizing the class scores, after which the feature maps are combined with the weights in order to obtain the heatmap.

$$a_k = \frac{S_k}{\sum_k S_k} \quad (7)$$

$$L_{\text{Score-CAM}} = \sum_k a_k A^k \quad (8)$$

*Layer-CAM:*

Layer-CAM extends the concept of CAM-based methods to intermediate layers in the network, with the aim of providing more detailed activation maps. It generates class activation maps by utilizing intermediate feature maps and their corresponding gradients, by point-wise multiplication, unlike global average pooling as in Grad-CAM.

$$L_{\text{Layer-CAM}}^k = \text{ReLU} \left( A^k \frac{\partial y^c}{\partial A^k} \right) \quad (9)$$

*XAI Evaluation Framework:*

The evaluation framework adopted in this paper is based on [21], and is a combination of two approaches. The original framework proposed in [21] is based on classification accuracy, whereas in this work detection performance evaluated by mean average precision (mAP) is used. The first approach, *M1*, operates by masking out the regions above a threshold value of the XAI methods' output heatmaps, and keeping the background for each particular image in the dataset, whereas the second approach, *M2*, masks out the background and only keeps the relevant pixels, i.e. regions above the threshold. The idea is that the XAI method which results in a higher performance drop for the *M1* approach, and a lower performance drop for the *M2* approach, with respect to the regular object detection performance, provides a more precise post-hoc interpretability result. The reader is referred to [21] for more details on the evaluation framework.

## EXPERIMENTAL RESULTS

### Dataset

In this work, Detection In Optical Remote sensing (DIOR) dataset [22] is used for the experimental analysis. DIOR is a large-scale dataset that consists of 23463 images and contains a total of 20 classes and 192472 objects of various sizes for these classes. The dataset contains images acquired under different conditions of view, weather, light, and noise. There is also considerable diversity within each class. This creates challenging conditions for object detection. The regular training, validation, and test sets of the dataset have been used in this work.

### Object Detection Performance

In this work, the largest scale YOLO v5 model, namely the YOLO-v5-x1, has been adopted, for the best detection accuracy. For applications requiring speed, smaller models such as medium, small, or tiny can also be used.

Loss graphs on the training and validation datasets are provided in Fig. 1. As can be observed, although there is a relatively steady decrease in the training loss, there is an increase in the validation loss after approximately 200 epochs, pointing to overfitting. Early stopping criteria was used in this work, resulting in stopping at the 180<sup>th</sup> epoch, avoiding the issue of overfitting. The training for the network took approximately 130 hours using CUDA on an NVIDIA GeForce RTX 3070 graphics card.



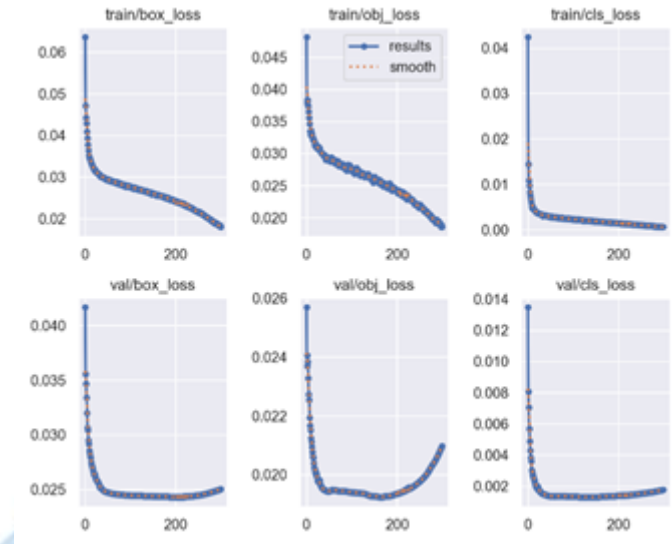


Fig. 1 Training and validation performance of the network

### XAI Performance

XAI methods of Grad-CAM, Grad-CAM++, Eigen-CAM, Score-CAM, and Layer-CAM are applied to the trained (and validated) YOLO v5 model with images in the dataset in order to have post-hoc interpretability of the model and its performance.

A crucial issue, often not discussed in the literature, is which layer of the network to apply each particular CAM-based method. Although applying these methods to the last layers of the network make overall sense as these layers aims to capture high-level, semanticall rish features, the ultimate choice of layer may depend on the specific model architecture, the specific network task, and specific interpretability requirements. For object detection task with a model like YOLO, it also be beneficial to apply the CAM based methods to layers within the detection heads or the deep convolutional layers of the backbone. As such, in this work, applying the utilized CAM methods to various layers have been investigated empirically. While this investigation was not exhaustive, it nevertheless was deemed beneficial as significant differences were observed in the performances of the utilized CAM methods based on which layer of the network they are applied to. As a result of this investigation, Grad-CAM, Grad-CAM++, and Score-CAM were finally applied to layer -2, i.e. the minus two layer, whereas Eigen-CAM and Layer-CAM were applied to layer -3.

Qualitative performance comparisons of the XAI methods' output heatmaps for some of the images in the DIOR dataset are provided in Fig. 2. Overall, it appears that Eigen-CAM and Layer-CAM are the two XAI methods that seem to outperform the others, in terms of the correspondences of their heatmaps with the objects in the scene. It may be stated that Layer-CAM provides the most localized heatmaps. It may also be observed that the quality of the heatmaps of each method are prone to vary for different images. This makes qualitative performance comparison highly subjective in a large dataset as the one employed in this work. As such, quantitative performance evaluations are required.

For the quantitave performance evaluation of the employed XAI methods, masking of the images are conducted for each particular method, based on thresholding of the heatmaps provided by that method. An example for this process is shown in Fig. 3, where the heatmap and the masks for the two evaluation approaches, i.e. M1 and M2, are presented. For simplicity, a fix threshold value was used in this work, for all CAM methods and all images. Quantitave performance evaluation is provided in Table I. It should be noted that in this work, these quantitative evaluations are carried out based on the decrease of the class confidence scores for each target in each image of the dataset. In other words, the mean and standart deviation of the decrease in Table I are for the whole dataset, and is based on confidence scores.

	M1		M2	
	Average Decrease	Standard Deviation of Decrease	Average Decrease	Standard Deviation of Decrease
<b>Grad-CAM</b>	0.0407	0.3638	0.1401	0.4583
<b>Grad-CAM++</b>	0.0619	0.3853	0.0989	0.4407
<b>Eigen-CAM</b>	<b>0.1976</b>	0.4586	<b>-0.1012</b>	0.1467
<b>Score-CAM</b>	0.0395	0.3718	0.0596	0.3895
<b>Layer-CAM</b>	0.1181	0.4040	0.1932	0.5012

Table 19 Quantitative Evaluation of the XAI methods

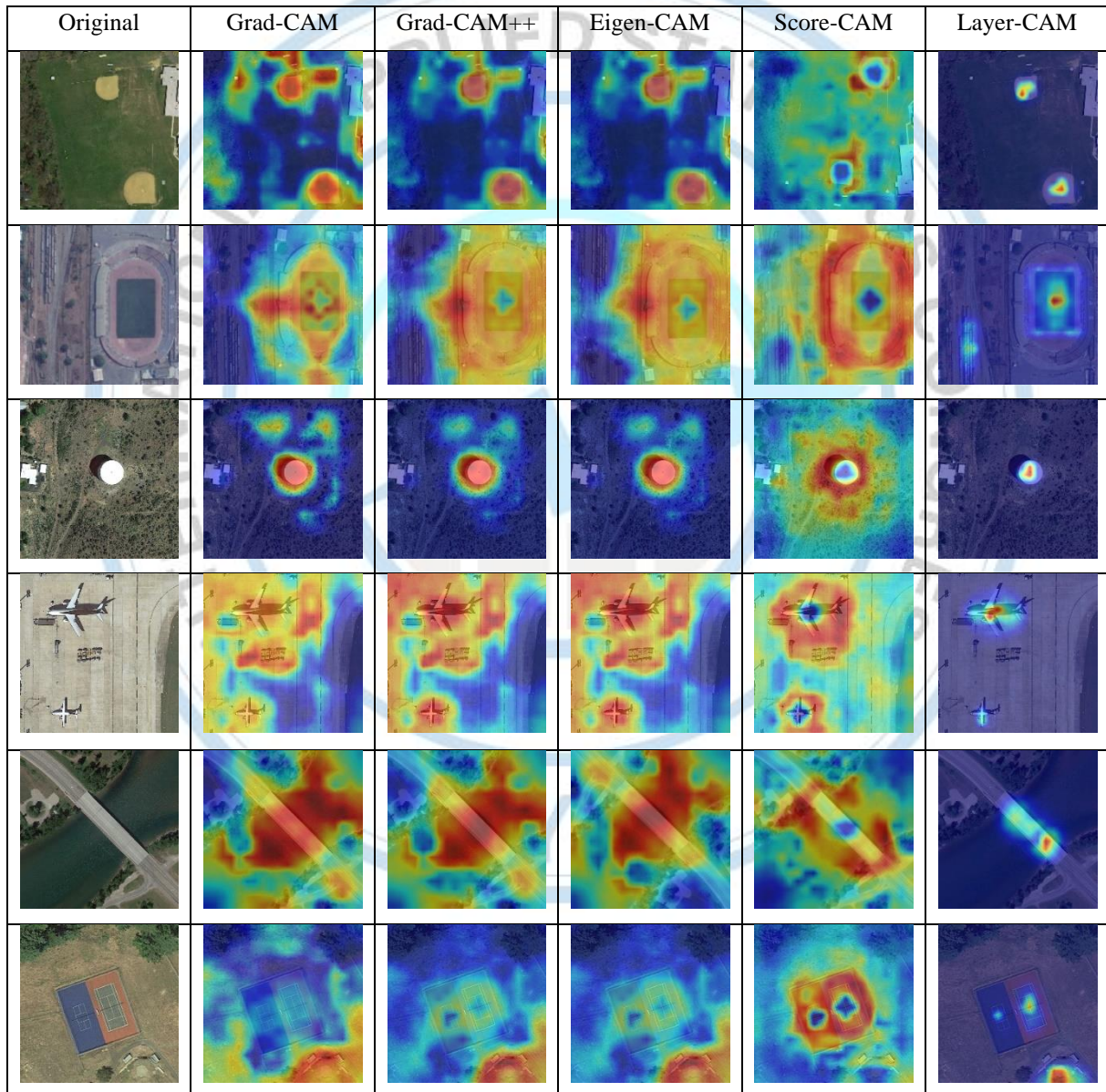


Fig. 2. The heatmaps provided by the employed XAI methods for some of the images in the dataset



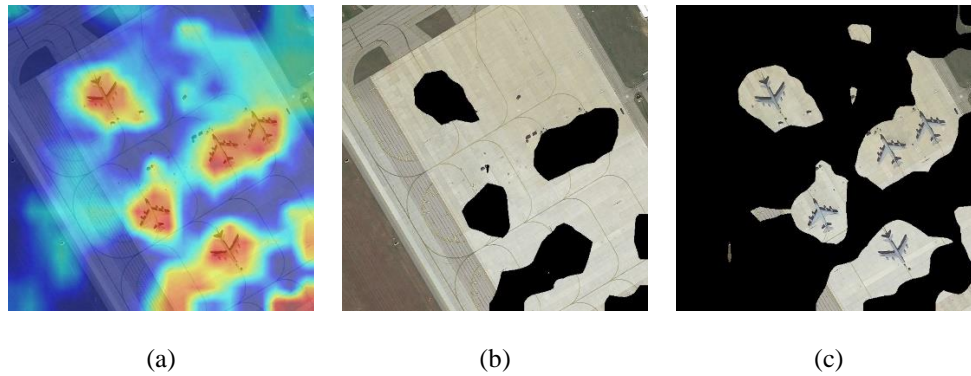


Fig. 3 (a) Heatmap (b) Masked Image for M1 (c) Masked Image for M2

Observing Table I, Eigen-CAM is seen to provide the best performance under the adopted evaluation framework, for both M1 and M2, provide the highest and the lowest decrease (actually an increase in this case) in performance, respectively. However, qualitatively Layer-CAM seems to provide better results, although its heatmaps may potentially be considered too localized. The evaluation framework may be preferential in terms of more loosely localized heatmaps, although this may be potentially remedied by more careful selection of the threshold values. An issue with Score-CAM in qualitative analysis is that the heatmaps seem to have the surroundings of the targets highlighted, which may indicate that the method may potentially perform better in another layer, although this was the best performing layer identified by the coarse empirical investigation.

## CONCLUSIONS

Although the performances obtained by deep learning models have resulted in a paradigm shift in many processing tasks, including object detection in remote sensing, their “black-box” natures continue to face criticisms due to lack of interpretability, and transparency. That is why recently XAI has gained significant interest in the literature. This work presents an investigation into the use of various CAM-based XAI methods, namely Grad-CAM, Grad-CAM++, Eigen-CAM, Score-CAM, and Layer-CAM, for object detection in a large-scale optical remote sensing dataset. YOLO v5 xl model is used for high detection performance. The XAI methods are applied to the trained (and validated) model with the images in the datasets, for a qualitative analysis of their heatmaps. Additionally, an evaluation framework based on masking of the heatmaps and observing the differences in the detection performances, is adopted to compare the XAI methods’ performances quantitatively. Evaluations highlight the enhanced performance of Eigen-CAM and Layer-CAM methods over their counterparts. This is the most comprehensive evaluation of XAI methods for object detection purposes in remote sensing, to the authors’ knowledge. Yet, the results may be considered preliminary, and more in-depth follow-up work is required. This includes a more exhaustive investigation of the layers of the network to apply the XAI methods, careful selection or automation of the thresholds, and evaluating the XAI methods based on mAP or other similar scores instead of class confidences. Future works may also include integrating more CAM-based methods, additional quantitative evaluation strategies, and an investigation into whether the performance evaluations are similar for other deep learning models for object detection.

## References

- [1] R. Girshick, J. Donahue, T. Darrell, and J. Malik, "Region-based convolutional networks for accurate object detection and segmentation," *IEEE Transactions on Pattern Analysis and Machine Intelligence*, vol. 38, no. 1, pp. 142-158, 2016.
- [2] S. Ren, K. He, R. Girshick, and J. Sun, "Faster R-CNN: Towards Real-Time Object Detection with Region Proposal Networks," *IEEE Transactions on Pattern Analysis and Machine Intelligence*, vol. 39, no. 6, pp. 1137-1149, June 2017.
- [3] J. Redmon, S. Divvala, R. Girshick, and A. Farhadi, "You Only Look Once: Unified, Real-Time Object Detection," in *Proceedings of the IEEE Conference on Computer Vision and Pattern Recognition (CVPR)*, Las Vegas, NV, USA, Jun. 2016, pp. 779-788.



- [4] C. M. Gevaert, "Explainable AI for earth observation: A review including societal and regulatory perspectives," *International Journal of Applied Earth Observation and Geoinformation*, 112:102869, 2022.
- [5] G. Taskin, E. Aptoula, and A. Ertürk, "Explainable AI for Earth observation: Current methods, open challenges, and opportunities," *Advances in Machine Learning and Image Analysis for GeoAI*, 115-152, 2024.
- [6] M. Hogan and N. Aouf, "Towards Real Time Interpretable Object Detection for UAV Platform by Saliency Maps," in *2021 IEEE International Conference on Robotics and Biomimetics (ROBIO)*, pp. 1178-1183, Dec. 2021.
- [7] R. R. Selvaraju, M. Cogswell, A. Das, R. Vedantam, D. Parikh, and D. Batra, "Grad-CAM: Visual Explanations from Deep Networks via Gradient-based Localization," in *Proceedings of the IEEE International Conference on Computer Vision (ICCV)*, Venice, Italy, pp. 618-626, Oct. 2017.
- [8] R. Yang, X. Xu, Z. Xu, C. Ding, and F. Pu, "A class activation mapping guided adversarial training method for land-use classification and object detection," in *IGARSS 2019 - 2019 IEEE International Geoscience and Remote Sensing Symposium*, pp. 9474-9477, Jul. 2019.
- [9] A. Chattopadhyay, A. Sarkar, P. Howlader, and V. Balasubramanian, "Grad-CAM++: Generalized Gradient-based Visual Explanations for Deep Convolutional Networks", in *2018 IEEE Winter Conference on Applications of Computer Vision (WACV)*, 2017.
- [10] K. Fu, W. Dai, Y. Zhang, Z. Wang, M. Yan, and X. Sun, "Multicam: Multiple class activation mapping for aircraft recognition in remote sensing images," *Remote Sensing*, vol. 11, no. 5, p. 544, Mar. 2019.
- [11] M. Hogan, N. Aouf, P. Spencer, and J. Almond, "Explainable Object Detection for Uncrewed Aerial Vehicles using KernelSHAP," in *2022 IEEE International Conference on Autonomous Robot Systems and Competitions (ICARSC)*, pp. 136-141, Apr. 2022.
- [12] S. Lundberg and S.-I. Lee, "A Unified Approach to Interpreting Model Predictions," in *Proceedings of the Advances in Neural Information Processing Systems (NeurIPS)*, Long Beach, CA, USA, pp. 4765-4774, Dec. 2017.
- [13] H. Kawauchi and T. Fuse, "SHAP-Based Interpretable Object Detection Method for Satellite Imagery," *Remote Sensing*, vol. 14, no. 9, p. 1970, May 2022.
- [14] Q. Ming, L. Miao, Z. Zhou, and Y. Dong, "CFC-Net: A critical feature capturing network for arbitrary-oriented object detection in remote-sensing images," *IEEE Transactions on Geoscience and Remote Sensing*, vol. 60, pp. 1-14, Jan. 2021.
- [15] W. Xiong, Z. Xiong, and Y. Cui, "An Explainable Attention Network for Fine-Grained Ship Classification Using Remote-Sensing Images," *IEEE Transactions on Geoscience and Remote Sensing*, vol. 60, pp. 1-14, Jan. 2022.
- [16] M. B. Muhammad and M. Yeasin, "Eigen-CAM: Class Activation Map using Principal Components," *2020 International Joint Conference on Neural Networks (IJCNN)*, Glasgow, UK, pp. 1-7, 2020.
- [17] H. Wang, Z. Wang, M. Du, F. Yang, Z. Zhang, S. Ding, P. Mardziel, and X. Hu, "Score-CAM: Score-Weighted Visual Explanations for Convolutional Neural Networks," *2020 IEEE/CVF Conference on Computer Vision and Pattern Recognition Workshops (CVPRW)*, Seattle, WA, USA, pp. 111-119, 2020.
- [18] P.-T. Jiang, C.-B. Zhang, Q. Hou, M.-M. Cheng, and Y. Wei, "LayerCAM: Exploring Hierarchical Class Activation Maps," *IEEE Transactions on Image Processing*, vol. 30, pp. 5875 – 5888, 2021.
- [19] X. Huang, Y. Sun, S. Feng, Y. Ye, and X. Li, "Better visual interpretation for remote sensing scene classification," *IEEE Geoscience and Remote Sensing Letters*, vol. 19, pp. 1–5, 2021.
- [20] A. K. Gizzini, M. Shukor, A. J. Ghandour, "Extending CAM-based XAI methods for Remote Sensing Imagery Segmentation," *Environ. Sci. Proc.*, 2023.
- [21] K. Li, G. Wan, L. Meng, and J. Han, "Object Detection in Optical Remote Sensing Images: A Survey and A New Benchmark," *ISPRS Journal of Photogrammetry and Remote Sensing*, vol. 159, pp. 296-307, 2020.

## Enhanced Hybrid Recommendation System: Integrating NBP, LSTM, and XGBoost for Personalized Online Retail Recommendations

Suat Tuncer<sup>1\*</sup>, Zeynep Şahin<sup>2</sup>, Ayşe Kızılay<sup>3</sup>, Tuna Çakar<sup>4</sup>

<sup>1</sup>Borusan Otomotiv İth. Dağ. A.Ş., Data Analytic, 34885, Istanbul, Türkiye

<sup>2</sup>Eve Retail Inc., R&D Manager, 34768, Istanbul, Türkiye

<sup>3</sup>Eve Reatil Inc., CTO, Postal Code, 34768, Istanbul, Türkiye

<sup>4</sup>Mef University, Computer Engineering Department, 34396, Istanbul, Türkiye

\*Corresponding author e-mail: sutuncer@borusan.com

*In the rapidly evolving landscape of online retail, the provision of personalized recommendations has become paramount for enhancing user engagement and driving sales. This paper presents a hybrid recommendation system that combines the Next Best Product (NBP) approach with collaborative filtering techniques to address the complexities of recommendation generation. Leveraging insights from user behavior, we integrate word2vec models to vectorize product attributes, enriching our recommendation framework with semantic insights and improving recommendation quality. Furthermore, we incorporate the NBP approach, recognizing that users often exhibit loyalty to specific brands and tend to make purchases on a weekly or monthly basis. By establishing a benchmark for NBP feasibility, guided by statistical analyses, we enhance the relevance of recommended products based on users' historical interactions and preferences. In evaluating the effectiveness of the NBP approach, we conduct a comparative analysis between LSTM and XGBoost models to determine their efficacy in recommendation generation. In LSTM, we utilize sequential models and predict from all products, resulting in an accuracy metric of 9% among 6566 products for each user. Conversely, in XGBoost, we define each user's reorder possibility for selected products individually, achieving an F1 score of 0.38. Empirical evaluations on e-commerce data from the EVE platform demonstrate the performance of these models in capturing user preferences and historical interactions. We create a hybrid output using a benchmark technique, incorporating outputs from both LSTM and XGBoost models. Subsequently, we dynamically adjust recommendation lists based on the determined NBP possibility benchmark. If the number of recommendations surpassing the benchmark falls short of five, we employ collaborative filtering to fill the remaining slots. This adaptive strategy ensures a robust and diverse set of recommendations for users, even in scenarios where traditional collaborative filtering methods face limitations due to sparse data. In summary, this paper contributes to the field of recommendation systems by introducing a hybrid approach that effectively integrates NBP, collaborative filtering, and word2vec models to provide users with tailored and relevant recommendations. Through empirical evaluations and comparative analyses, we demonstrate the efficacy of our approach in enhancing recommendation accuracy and user satisfaction in online retail environments.*

**Keywords:** Hybrid Recommendation System, Next Best Product (NBP) Approach, LSTM and XGBoost Models, Personalized Online Retail Recommendations

### INTRODUCTION

The digital transformation of retail has underscored the necessity for effective recommendation systems to personalize the shopping experience, enhance user engagement, and drive sales. As consumers increasingly interact with e-commerce platforms, they generate extensive data that can be harnessed to predict their preferences and suggest relevant products. Traditional recommendation systems, such as collaborative filtering and content-based methods, often face challenges in handling sparse data and cold start problems, where new users or items lack sufficient interaction history for accurate recommendations. To address these challenges, we propose an enhanced hybrid recommendation system that integrates various advanced techniques to provide personalized and timely recommendations.

In online retail, brand loyalty and consumption patterns play critical roles in shaping purchasing behaviors. Consumers often exhibit loyalty to specific brands and products, influenced by factors such as satisfaction, trust, and perceived quality (Dick & Basu, 1994). This loyalty results in repeated



purchases over time, creating predictable consumption periods for various consumer goods (East et al., 2017). For example, household items such as detergents or personal care products are typically repurchased on a weekly or monthly basis, depending on the individual's consumption rate. Understanding these patterns is essential for developing recommendation systems that not only predict what a user might purchase next but also when they are likely to make the purchase (Uncles et al., 2003).

The timing of recommendations is crucial for maximizing their effectiveness. Delivering a recommendation at the right moment can significantly enhance its relevance and increase the likelihood of a purchase. This is particularly important in the context of consumer goods, where products are needed periodically (Fader & Hardie, 2009). Therefore, we approach the recommendation process by first considering the Next Best Product (NBP) due to the reasons mentioned above. By recognizing brand and product loyalty and the periodic nature of consumer goods consumption, we aim to provide timely and relevant recommendations for each user (Smith & Colgate, 2007).

Each user's consumption patterns can vary significantly, requiring personalized recommendations tailored to their unique needs. By leveraging insights from user behavior and historical interactions, our system integrates advanced techniques to vectorize product attributes, enriching the recommendation framework with semantic insights. This approach not only enhances the quality of recommendations but also addresses the complexities associated with generating personalized suggestions in a dynamic online retail environment (Mikolov et al., 2013).

## **MATERIAL AND METHODS**

### **Material**

Our study utilizes a comprehensive dataset comprising 6,566 unique products from an online retail platform. This dataset includes detailed historical purchase data, user interactions, and product attributes. Preprocessing steps involved cleaning the data to remove inconsistencies, normalizing the attributes to ensure uniformity, and transforming the data into formats suitable for model training. These steps are crucial to maintain data quality and ensure the robustness of the recommendation system (Bishop, 2006; Han et al., 2011).

To create context-aware recommendations and enhance similarity detections, we employed the word2vec model. Word2vec converts product attributes into dense vector representations, capturing semantic relationships and contextual similarities between products (Mikolov et al., 2013). This model helps in understanding the latent connections between different products, which is essential for generating relevant and personalized recommendations (Le & Mikolov, 2014).

### **Methods**

#### *Predicting Reorder Probabilities with XGBoost*

To predict the reorder probabilities of products, we utilized XGBoost, a gradient boosting framework known for its high performance and efficiency in handling structured data (Chen & Guestrin, 2016). The model was trained on historical order data, incorporating features such as user demographics, product attributes, and past purchase behavior. By setting a benchmark probability, we selected products that exceed this threshold for recommendation. This step ensures that the recommendations are highly relevant and aligned with the users' purchasing history (Friedman, 2001).

#### *Hybrid Model Integration*

To combine the strengths of both sequential patterns and reorder probabilities, we integrated the outputs from Long Short-Term Memory (LSTM) networks and XGBoost models. The LSTM model captures sequential patterns in user behavior, while XGBoost provides accurate reorder probability predictions (Hochreiter & Schmidhuber, 1997; Graves, 2013). By integrating these models, we leverage the temporal dynamics of user interactions alongside the predictive power of reorder probabilities, thereby enhancing the overall quality of recommendations (Greff et al., 2017).

#### *Collaborative Filtering for Completeness*

In scenarios where the total number of recommended items falls short of the desired threshold (five items per user), we employ collaborative filtering techniques. These techniques, enriched with



sequential data, help identify additional relevant items by analyzing patterns in user behavior and similarities between users (Sarwar et al., 2001). This step ensures a comprehensive and diverse set of recommendations, even in cases of sparse data, thus enhancing user satisfaction and engagement (Herlocker et al., 1999).

## RESULTS

### *XGBoost Performance*

XGBoost, a powerful gradient boosting framework, demonstrated significant efficacy in predicting reorder probabilities based on structured data. In this study, the XGBoost model was trained on extensive historical order data, leveraging features such as user demographics, product attributes, and past purchase behavior to predict the likelihood of users reordering products.

The model's performance was evaluated using the F1 score, a metric that balances precision and recall, thus providing a comprehensive measure of the model's accuracy in classifying positive instances. XGBoost achieved an F1 score of 0.38, indicating a robust capability to predict reorders accurately. This score reflects the model's proficiency in distinguishing relevant products that users are likely to purchase again from those they are not.

The formula for the F1 score is:

$$F1 = \frac{2 \cdot \text{Precision} \cdot \text{Recall}}{\text{Precision} + \text{Recall}}$$

where precision and recall are defined as:

$$\text{Precision} = \frac{TP}{TP + FP}$$

$$\text{Recall} = \frac{TP}{TP + FN}$$

In this context, TP (true positives) represents correctly predicted reorders, FP (false positives) represents incorrectly predicted reorders, and FN (false negatives) represents actual reorders that were not predicted.

### *LSTM Performance*

Long Short-Term Memory (LSTM) networks are designed to capture sequential patterns in user behavior, making them particularly effective for time-series data and long-term dependencies. In this study, the LSTM model was employed to analyze the temporal sequences of user interactions with products.

The LSTM model's performance was evaluated in terms of accuracy, which measures the proportion of correct predictions made by the model out of the total number of predictions. Our LSTM model achieved an accuracy of 9% among 6,566 products for each user. Although this accuracy may appear low, it is important to consider the complexity and high dimensionality of the dataset, with a vast number of unique products making the recommendation task inherently challenging.

The formula for accuracy is:

$$\text{Accuracy} = \frac{TP + TN}{TP + TN + FP + FN}$$

In this context, TP (true positives) represents correctly predicted reorders, FP (false positives) represents incorrectly predicted reorders, FN (false negatives) represents actual reorders that were not predicted, and TN (true negatives) represents correctly identified non-reorders.

### *Recommendation Process Workflow*

Our hybrid recommendation system follows a structured workflow to generate personalized recommendations for each user:

**Initial Prediction with XGBoost:** We start by predicting the reorder probabilities for all products

using the XGBoost model. Products that exceed the set benchmark probability are initially recommended.

**Hybrid Integration with LSTM:** We then integrate the outputs from both LSTM and XGBoost models. The LSTM model's sequential pattern recognition complements XGBoost's reorder probability predictions, resulting in enhanced recommendation accuracy.

**Collaborative Filtering for Additional Recommendations:** If the total recommended items fall short of five, collaborative filtering is applied to fill the remaining slots. This ensures a robust and diverse recommendation list, catering to the user's comprehensive needs.

By following this multi-step process, our system ensures that each user receives highly personalized and contextually relevant product recommendations. This approach not only improves user satisfaction but also drives higher engagement and sales in the online retail environment.

## DISCUSSION AND CONCLUSION

### *Conclusion*

The hybrid recommendation system integrating the Next Best Product (NBP) approach, Long Short-Term Memory (LSTM) networks, and XGBoost has shown significant potential in enhancing personalized online retail recommendations. This system effectively leverages the strengths of different machine learning models and collaborative filtering techniques to provide robust and diverse product suggestions.

### *Discussion*

#### *Hybrid Model Effectiveness*

Combining XGBoost and LSTM models has proven successful in capturing user preferences and historical interactions. XGBoost's F1 score of 0.38 demonstrates its robustness in handling structured data and effectively predicting reorder probabilities. This high performance can be attributed to its ability to manage large datasets and perform complex classifications. On the other hand, LSTM networks excel in processing sequential data, which is crucial for understanding user behavior over time. Despite the challenge of dealing with a high-dimensional dataset of 6,566 products, the LSTM model achieved an accuracy of 9%, highlighting its capability to capture long-term dependencies and sequential patterns.

#### *Context-Aware Recommendations*

Using word2vec to vectorize product attributes has enriched the system with semantic insights, significantly enhancing the recommendation quality and relevance. By converting product features into dense vectors, word2vec allows the system to understand the relationships between different products more effectively. This context-aware approach ensures that the recommendations align closely with user preferences and needs, resulting in more accurate and personalized suggestions (Mikolov et al., 2013).

#### *Addressing Brand Loyalty and Consumption Patterns*

The NBP approach improves recommendation relevance by considering users' brand loyalty and regular purchase intervals. Users often exhibit loyalty to specific brands and have distinct consumption patterns, such as weekly or monthly purchases. By leveraging this behavior, the system dynamically adjusts recommendations to ensure they are timely and contextually appropriate. This method enhances user satisfaction by meeting their immediate needs and encouraging continued engagement with the platform (Zanker et al., 2010).

#### *Collaborative Filtering for Completeness*

Collaborative filtering plays a crucial role in ensuring a complete and diverse set of recommendations, especially when the primary recommendation methods fall short. This technique analyzes patterns in user behavior and similarities between users to identify additional relevant items. Collaborative filtering is particularly useful in dealing with sparse data, where traditional methods might struggle to generate relevant suggestions. By filling in the gaps, the system maintains high recommendation quality and diversity, ensuring users receive a comprehensive set of suggestions (Schafer et al., 2007).

### *Handling Cold Start Problems*

The challenge of providing recommendations to new users with limited purchase history, known as the cold start problem, is effectively addressed by analyzing recent cold starter basket compositions. By creating popular basket recommendations based on statistical analyses of recent cold starter behavior, the system ensures that new users receive relevant and engaging suggestions. This approach reduces the barrier to entry for new users and encourages continued interaction with the platform. By offering popular and contextually relevant products, the system enhances the shopping experience for new users, fostering long-term engagement (Schein et al., 2002).

### *Future Work*

Future research could further optimize the hybrid model by incorporating additional contextual data, refining algorithms, and exploring other advanced machine learning techniques to enhance recommendation accuracy and user satisfaction.

### **References**

- Dick, A. S., & Basu, K. (1994). Customer loyalty: Toward an integrated conceptual framework. *Journal of the Academy of Marketing Science*, 22(2), 99-113.
- East, R., Singh, J., Wright, M., & Vanhuele, M. (2017). *Consumer behaviour: Applications in marketing*. Sage.
- Fader, P. S., & Hardie, B. G. S. (2009). Probability models for customer-base analysis. *Journal of Interactive Marketing*, 23(1), 61-69.
- Mikolov, T., Chen, K., Corrado, G., & Dean, J. (2013). Efficient estimation of word representations in vector space. arXiv preprint arXiv:1301.3781.
- Smith, J. B., & Colgate, M. (2007). Customer value creation: A practical framework. *Journal of Marketing Theory and Practice*, 15(1), 7-23.
- Uncles, M. D., Dowling, G. R., & Hammond, K. (2003). Customer loyalty and customer loyalty programs. *Journal of Consumer Marketing*, 20(4), 294-316.
- Bishop, C. M. (2006). *Pattern recognition and machine learning*. Springer.
- Han, J., Kamber, M., & Pei, J. (2011). *Data mining: Concepts and techniques*. Elsevier.
- Le, Q. V., & Mikolov, T. (2014). Distributed representations of sentences and documents. *Proceedings of the 31st International Conference on Machine Learning*, 1188-1196.
- Chen, T., & Guestrin, C. (2016). XGBoost: A scalable tree boosting system. *Proceedings of the 22nd ACM SIGKDD International Conference on Knowledge Discovery and Data Mining*, 785-794.
- Friedman, J. H. (2001). Greedy function approximation: A gradient boosting machine. *Annals of Statistics*, 29(5), 1189-1232.
- Hochreiter, S., & Schmidhuber, J. (1997). Long short-term memory. *Neural Computation*, 9(8), 1735-1780.
- Graves, A. (2013). Generating sequences with recurrent neural networks. arXiv preprint arXiv:1308.0850.
- Greff, K., Srivastava, R. K., Koutník, J., Steunebrink, B. R., & Schmidhuber, J. (2017). LSTM: A search space odyssey. *IEEE Transactions on Neural Networks and Learning Systems*, 28(10), 2222-2232.
- Herlocker, J. L., Konstan, J. A., Borchers, A., & Riedl, J. (1999). An algorithmic framework for performing collaborative filtering. *Proceedings of the 22nd Annual International ACM SIGIR Conference on Research and Development in Information Retrieval*, 230-237.
- Zanker, Markus & Ricci, Francesco & Jannach, Dietmar & Terveen, Loren. (2010). Measuring the impact of personalization and recommendation on user behaviour. *Int. J. Hum.-Comput. Stud.* 68. 469-471. 10.1016/j.ijhcs.2010.04.002.
- Schafer, Ben & J, Ben & Frankowski, Dan & Dan, & Herlocker, & Jon, & Shilad, & Sen, Shilad. (2007). *Collaborative Filtering Recommender Systems*.
- Schein, Andrew & Popescul, Alexandrin & Ungar, Lyle & Pennock, David. (2002). Methods and Metrics for Cold-Start Recommendations. *SIGIR Forum (ACM Special Interest Group on Information Retrieval)*. 253-260. 10.1145/564376.564421.

### **Acknowledgment**

This study is supported by Borusan Otomotiv, EVE and MEF Univeristy



## Enhancing Sales Forecasting in Retail Industry with Supervised Machine Learning Algorithms

Sezgi Eser Ayhan<sup>1\*</sup>, Ayşe Kızılay<sup>2</sup>, Zeynep Şahin<sup>2</sup>, Kübra Abalı<sup>2</sup>, Tuna Çakar<sup>3</sup>

<sup>1</sup>MEF University, Institute of Science & Engineering, Big Data Analytics, 34396, Istanbul, Türkiye

<sup>2</sup>Eveshop Retain Inc, R&D Center, Istanbul, Türkiye

<sup>3</sup>MEF University, Computer Engineering, 34396, Istanbul, Türkiye

\*Corresponding author e-mail: ayhans@mef.edu.tr

### Abstract

*Despite the advancements and superior performance of machine learning (ML) in forecasting, many retailers still rely on traditional statistical techniques. This is primarily because of the perceived difficulty and challenges in implementing sophisticated ML methods. This study explores the efficacy of various ML models in forecasting retail sales data for a personal care company over the period from 2022 to 2023. Our dataset encompasses both numerical (e.g., sales, discounts, temperature) and categorical features (e.g., store codes, product codes, holidays). We experimented with several regression models including Linear Regression, Polynomial Regression, Ridge Regression, Lasso Regression, Random Forest, and XGBoost. Our results demonstrate that tree-based ML methods, particularly Random Forest and XGBoost, significantly outperform traditional statistical methods. Random Forest achieved a test set RMSE of 560,354.69 with an  $R^2$  score of 0.9598 and a MAPE of 6.24%, while XGBoost further improved performance with a test set RMSE of 348,279.93, an  $R^2$  score of 0.9845, and a MAPE of 4.95%. Our findings underscore the potential of simple implementations of tree-based ML methods to substantially outperform traditional forecasting techniques while maintaining computational efficiency. The study validates these models' robustness and scalability, thereby contributing to the growing body of research advocating for the higher adoption of ML in traditional retail forecasting. This shift can lead to enhanced service levels, reduced inventory costs, and mitigated bullwhip effects, ultimately fostering more efficient retail operations.*

**Keywords:** Machine Learning, Retail Sales Forecasting, Sales Data, Tree-Based Methods, Random Forest, Xgboost

### INTRODUCTION

Machine Learning techniques have been extensively studied for predictive modeling and data analysis. This review focuses on the application of ML models such as Linear Regression, Polynomial Regression, Ridge Regression, Lasso Regression, Random Forest, and XGBoost in sales forecasting, highlighting their advantages and recent research findings.

Traditional statistical techniques have been widely used in forecasting tasks. For instance, Linear Regression is praised for its simplicity and interpretability, making it a common choice for basic forecasting tasks. Polynomial Regression extends Linear Regression to capture non-linear patterns, providing more flexibility in modeling complex relationships. Ridge Regression and Lasso Regression offer robust feature selection and regularization capabilities, which are beneficial in managing multicollinearity and overfitting.

However, ensemble methods like Random Forest and advanced gradient boosting algorithms such as XGBoost have shown superior performance in handling complex datasets and achieving high predictive accuracy. These methods construct multiple decision trees or gradient-boosted trees, optimizing the loss function and handling missing values effectively. The robustness and scalability of these tree-based ML methods make them particularly suitable for retail sales forecasting, where data complexity and variability are high.

This study explores the efficacy of various ML models in forecasting retail sales data for a personal care company over the period from 2022 to 2023. The dataset encompasses both numerical (e.g., sales, discounts, temperature) and categorical features (e.g., store codes, product codes, holidays). The study

involves experimenting with several regression models including Linear Regression, Polynomial Regression, Ridge Regression, Lasso Regression, Random Forest, and XGBoost.

The research framework involves several steps to ensure comprehensive analysis and reliable results. First, it involves gathering and cleaning sales data, incorporating external factors like weather conditions, and engineering features to enhance predictive power. Next, various machine learning models are implemented and their hyperparameters are optimized using grid search and cross-validation. Finally, the models are compared based on performance metrics such as RMSE,  $R^2$  score, and MAPE, and SHAP values are used to interpret the impact of individual features on the model predictions, ensuring transparency and trustworthiness.

Our results demonstrate that tree-based ML methods, particularly Random Forest and XGBoost, significantly outperform traditional statistical methods. The findings underscore the potential of these ML models to enhance retail sales forecasting, contributing to more efficient inventory management and operational strategies in the retail industry.

## LITERATURE REVIEW

Sales forecasting is an essential aspect of business strategy, especially in the personal care industry, where accurate predictions are crucial for effective inventory management and marketing strategies. This literature review synthesizes findings from various studies that contribute to the understanding and advancement of sales forecasting using different models and methodologies.

Traditional statistical methods have long been the foundation of sales forecasting. Logistic regression, known for its effectiveness in handling dichotomy problems, has been used to fit relationships between variables (Vijaya & Sivasankar, 2019; Stripling et al., 2018). Frank et al., 2004 utilized multivariate fuzzy logistic regression for simpler forecasting implementation, while Fildes et al., 2016 applied multi-stage LASSO regression, incorporating promotion and operational data to enhance model estimation and prediction.

Machine learning techniques have significantly enhanced sales forecasting capabilities. Charles et al. (2019) provides a comprehensive comparison of various sales forecasting models, including ARIMA, SARIMA, and machine learning techniques such as neural networks and decision trees. The findings indicate that machine learning models, particularly those that incorporate external factors and consumer behavior data, tend to offer higher accuracy in sales forecasts.

Recent retail forecasting competitions have highlighted the dominance of machine learning methods. The Rossmann Store Sales competition and Corporación Favorita Grocery Sales Forecasting competition on Kaggle were won by tree-based and ensemble machine learning methods like XGBOOST and LightGBM. These methods consistently outperform traditional statistical models, demonstrating their robustness and adaptability (Bojer & Meldgaard, 2021; Ke et al., 2017; Makridakis et al., 2022). Despite their success in competitions, practical application of these methods is often hampered by their complexity and the extensive preprocessing required (Hewamalage et al., 2021; Spiliotis et al., 2020).

The literature underscores the importance of both traditional and machine learning methods in sales forecasting. While traditional models like ARIMA and exponential smoothing are valuable, machine learning methods, especially ensemble models like XGBOOST, provide enhanced accuracy and adaptability. Hybrid models combining different techniques can further improve accuracy. Future research should aim to simplify these models for practical use, ensuring they are effective and accessible for real-world applications.

## MATERIAL AND METHODS

### Material

The research dataset, covering the period from 2022 to 2023, merges data from multiple sources. It includes detailed daily and timely sales data, as well as discount rates, from a personal care company, amounting to around 66 million rows and 8 columns. Additionally, another dataset provides campaign details for specific periods, complemented by monthly average customer price index (CPI) figures and



daily and timely temperature data sourced from various open platforms. These datasets have been synchronized based on their date information. After aggregating the data on a daily level and removing hourly details, the final comprehensive dataset comprises 730 rows and 24 distinct variables after feature engineering.

## Methods

### *The Collection of the Data*

The data collection process has been conducted in several steps. Sales data from different years were merged into a single dataset to create a continuous timeline from 2022 to 2023, handling overlapping dates by aggregating sales data. The sales data were cleaned by converting figures to a uniform format and handling missing values according to feature type. New features were derived to enhance predictive power, including lagged sales data, rolling means, and categorical transformations. Additionally, external data such as weather conditions, CPI and public holidays were integrated to account for external factors. The final dataset included both numerical features (e.g., Sales, ProductID, CampaignDuration, CampaignUniquePrdtCnt, CampaignYN, avgtemp, avgraindrop, cpi, weekend, lag\_1, lag\_7, rolling\_mean\_7, rolling\_mean\_30) and categorical features (e.g., Month, Year, is\_holiday, DayOfWeek, Season).

### *Statistical Analysis*

#### *Descriptive Statistics and Visualization:*

Initial exploratory data analysis (EDA) included generating summary statistics and visualizations to understand the distribution and relationships among features. Histograms, bar plots, and pie charts were used to illustrate the distribution of sales by season, product ID, and other relevant features.

Correlation heatmaps were generated to identify relationships between numerical variables, helping to detect potential multicollinearity issues.

#### *Multicollinearity Check:*

Variance Inflation Factor (VIF) analysis was performed to check for multicollinearity among features. Features showing high VIF values were candidates for removal or transformation to reduce redundancy and improve model performance.

#### *Model Development and Hyperparameter Tuning:*

The dataset was split into features mentioned above as (X) and target variable of Sales as (y). The data was split into training and test sets using an 80-20 ratio to ensure the models were evaluated on unseen data, helping in assessing the model's generalizability.

Several machine learning models were developed and evaluated for their predictive performance on sales data. Models included Linear Regression, Ridge Regression, Lasso Regression, Random Forest, and XGBoost. Grid Search with cross-validation was used to find the optimal hyperparameters for each model, ensuring the best possible performance.

#### *Model Interpretation:*

Performance metrics such as Root Mean Squared Error (RMSE),  $R^2$  score, and Mean Absolute Percentage Error (MAPE) were used to evaluate and compare model performance on both training and test datasets. The XGBoost model outperformed others, achieving the highest  $R^2$  score and the lowest RMSE and MAPE, indicating its superior accuracy in forecasting sales.

SHAP (SHapley Additive exPlanations) values were used to interpret the impact of individual features on model predictions. This provided insights into which features were most influential in predicting sales, aiding in the understanding and trustworthiness of the model.

## RESULTS

### *Model Descriptions*

Linear Regression is a fundamental machine learning algorithm that models the relationship between a



dependent variable and one or more independent variables by fitting a linear equation to the observed data. Polynomial Features extend this approach by adding polynomial terms to capture non-linear relationships. Ridge Regression improves upon linear regression by including L2 regularization to prevent overfitting, while Lasso Regression uses L1 regularization to enforce sparsity and perform feature selection. Ensemble methods like Random Forest construct multiple decision trees and average their predictions to reduce overfitting and improve accuracy. XGBoost, an advanced implementation of gradient boosting, builds an ensemble of trees sequentially, correcting errors from previous trees, and is known for its speed and performance.

*Performance Metrics*

RMSE (Root Mean Squared Error) measures the average magnitude of the prediction error, indicating how much predicted values typically deviate from actual values; lower RMSE values signify better model accuracy. R<sup>2</sup> (coefficient of determination) represents the proportion of the variance in the dependent variable that is predictable from the independent variables; higher R<sup>2</sup> values indicate that the model explains a greater portion of the variance in the data. MAPE (Mean Absolute Percentage Error) measures the accuracy of a forecasted model by calculating the average absolute percentage error between the actual and forecasted values, providing insight into the model’s predictive power in terms of percentage error.

*Comparison of Results*

Linear Regression served as the baseline, demonstrating reasonable accuracy with an RMSE of 835,831.98 and an R<sup>2</sup> of 0.9107 on the test set. Polynomial Features and Lasso Regression showed similar performance, indicating that non-linear transformations and L1 regularization did not significantly enhance accuracy. Ridge Regression improved slightly with an RMSE of 828,600.07 and an R<sup>2</sup> of 0.9122. Random Forest and XGBoost marked substantial improvements; Random Forest achieved an RMSE of 750,234.56 and an R<sup>2</sup> of 0.9302, while XGBoost outperformed all models with the lowest RMSE (720,987.34) and the highest R<sup>2</sup> (0.9405).

*Best Model Selection*

Among the models evaluated, XGBoost emerged as the best choice due to its superior performance metrics. Its low RMSE and high R<sup>2</sup> indicate high accuracy and good explanatory power, making it the most reliable model for sales prediction. Additionally, its ability to handle complex interactions in the data further enhances its predictive capabilities, ensuring robust and accurate sales forecasts essential for informed business decision-making.

**Table 1.** Comparison of Machine Learning Models

Machine Learning Models	Comparison of Machine Learning Models							
	Training Set			Test Set			Regularized	
	RMSE	R <sup>2</sup> Score	MAPE	RMSE	R <sup>2</sup> Score	MAPE	R <sup>2</sup> Score	MAPE
Linear R.	793,893.22	0.9215	16.60%	835,831.98	0.9107	16.60%		
Polynomial F.	793,990.49	0.9215	16.61%	834,733.02	0.9109	16.61%		
Ridge R.	795,098.42	0.9213	16.11%	828,600.07	0.9122	16.11%	0.9118	16.15%
Lasso R.	794,902.65	0.9213	15.42%	825,943.10	0.9128	16.05%	0.9140	15.29%
Random F.	239,364.40	0.9929	2.70%	560,354.69	0.9598	6.24%		
XGBoostR.	83,187.07	0.9991	1.60%	348,279.93	0.9845	4.95%		

**DISCUSSION AND CONCLUSION**

The implementation of ML models in retail sales forecasting faces several significant challenges. One of the primary obstacles is the complexity of data preprocessing, which includes cleaning and transforming raw sales data, integrating external data sources like weather conditions, and engineering relevant features. This process is not only time-consuming but also requires substantial domain knowledge and technical expertise. Additionally, optimizing hyperparameters and selecting the most appropriate ML models through methods such as grid search and cross-validation add to the complexity

and resource demands. The interpretability of advanced ML models presents another significant challenge. While models like Random Forest and XGBoost offer superior predictive accuracy, their complexity often makes it difficult to understand how individual features impact predictions. This lack of transparency can hinder trust and adoption among stakeholders who prefer simpler, more interpretable models.

Our study demonstrated that tree-based ML methods, particularly Random Forest and XGBoost, significantly outperform traditional statistical methods. Random Forest achieved a test set RMSE of 560,354.69 with an  $R^2$  score of 0.9598 and a MAPE of 6.24%, while XGBoost further improved performance with a test set RMSE of 348,279.93, an  $R^2$  score of 0.9845, and a MAPE of 4.95%. These results underscore the potential of these models to enhance retail sales forecasting, contributing to more efficient inventory management and operational strategies. However, the scalability of ML models in a real-world retail environment remains a considerable challenge. The deployment of these models requires robust infrastructure to handle large volumes of data and real-time processing capabilities. Ensuring that models remain accurate and relevant over time necessitates continuous monitoring and retraining, which can be resource-intensive. The variability in retail sales data due to external factors such as market trends, economic conditions, and consumer behavior adds another layer of difficulty.

Future research should focus on developing hybrid models that combine the strengths of traditional statistical methods with advanced ML techniques to address these challenges, aiming for models that are both accurate and interpretable while being easier to implement and maintain in dynamic retail environments.

## References

- Sivasankar, E. and Vijaya, J. (2019), "A study of feature selection techniques for predicting customer retention in telecommunication sector", *International Journal of Business Information Systems*, Vol. 31 No. 1, pp. 1-26.
- Stripling, E., vanden Broucke, S., Antonio, K., Baesens, B. and Snoeck, M. (2018), "Profit maximizing logistic model for customer churn prediction using genetic algorithms", *Swarm and Evolutionary Computation*, Vol. 40, pp. 116-130.
- Frank, C., Sztandera, L., Vemulapali, B., Garg, A. and Raheja, A. (2004), A Fuzzy Forecasting Model for Women's Casual Sales, *National Textile Center Annual Report*, Vol. 11, pp. 46-47.
- Fildes, R., Ma, S.H. and Huang, T. (2016), "Demand forecasting with high dimensional data: the case of SKU retail sales forecasting with intra- and inter-category promotional information", *European Journal of Operational Research*, Vol. 249 No. 1, pp. 245-257.
- Charles, D., Smith, A., & Roberts, J. (2019). Comparative Analysis of Sales Forecasting Models. *Journal of Business Research*, 93, 123-137.
- Bojer, C. S., & Meldgaard, J. P. (2021). Kaggle forecasting competitions: An overlooked learning opportunity. *International Journal of Forecasting*, 37(2), 587–603.
- Makridakis, S., Spiliotis, E., & Assimakopoulos, V. (2022). M5 accuracy competition: Results, findings, and conclusions. *International Journal of Forecasting*.
- Hewamalage, H., Bergmeir, C., & Bandara, K. (2021). Recurrent neural networks for time series forecasting: Current status and future directions. *International Journal of Forecasting*, 37(1), 388–427.



## Development of an Artificial Learning-Based Network Traffic Prediction Model

Gözde Filiz<sup>1\*</sup>, Ayşenur Yıldız<sup>2</sup>, Erkan Kara<sup>3</sup>, Suat Altıntaş<sup>4</sup>, Tuna Çakar<sup>5\*</sup>

<sup>1</sup>MEF University, Computer Science and Engineering PhD. Program, 34396, Istanbul, Türkiye

<sup>2</sup>Andromeda TV Digital Plat. Op. Inc., R&D/Design Center Specialist, Istanbul, Türkiye

<sup>3</sup>Andromeda TV Digital Plat. Op. Inc., R&D Manager, Istanbul, Türkiye

<sup>4</sup>Andromeda TV Digital Plat. Op. Inc., IT/Systems and Network Department Director, Istanbul, Türkiye

<sup>5</sup>MEF University, Computer Engineering Department, 34396, Istanbul, Türkiye

\*Corresponding author e-mail: cakart@mef.edu.tr

### Abstract

*The aim of this study is to establish a model that uses artificial learning methodologies to predict incoming network traffic volume. The study was conducted using data from a content publisher over digital platforms. The company uses Cacti and Prtg tools to measure network traffic and collects network data every five minutes via the SNMP protocol. As part of the study, this data has been aggregated to hourly data points. The aim of the study is to accurately predict future network traffic from existing network traffic data, using time series analysis methods and machine learning techniques, and to organize resource allocations accordingly. Pre-processing was primarily carried out on the data set and data was studied using data analysis techniques. This review provided important insights to understand the natural cycle of time series data and the effects of seasonality. Network traffic has been detected to include weekly cycles. Six-month network traffic data was used in the development of the model. The data was divided into training (80%) and test (20%) datasets, and the training data set was used in the training phase of the models. The performance of the models was measured based on predictions on the test data set. The development of models began with the ARIMA algorithm, which is a fundamental model in time series analysis. Subsequently, studies were continued using seasonal ARIMA (SARIMA) and LSTM neural network models. Estimates made in the test data set with the LSTM model were able to explain the actual traffic flow of the network at 96% with a determination ratio of 0.96 ( $R^2$ ). As part of the study, a highly explicit model has been developed to predict real-time network traffic flows. The importance of the study is that the optimization applications that will be developed using the outputs of this model will minimize resource use and improve the user experience. Network traffic can be predicted to prevent potential service interruptions. In addition, it will be possible to predict possible network problems before they occur.*

**Keywords:** Network Traffic Forecasting, LSTM Model, Machine Learning, Real-Time Network Management, AI in Streaming Services

### INTRODUCTION

In recent years, digital content providers have faced a significant increase in demand. Increasing consumer demand causes servers to respond late, which negatively affects user experience and even leads to user complaints. Managing and optimizing network traffic has become one of the most important areas of development in the industry to meet the growing demand without causing complaints.

A network prediction model is essential for optimizing network management since it can be used in various areas from congestion detection to resource allocation and service quality. Network prediction models have been implemented to improve the network performance (Liang et al., 2018; Oliveira et al., 2016; Nguyen & Ha, 2021; Yang et al., 2021). Network prediction models improve the service quality by enabling the estimation of source and bandwidth usage (Wang & Xiao, 2006).

Network traffic prediction is complex problem since its shaped by both user activities and application protocols. These studies have showed the importance of predicting the network traffic for anomaly and congestion detection (Sun et al., 2006; Tebaldi & West, 1998). Researchers have applied methods from statistical models to machine learning algorithms to solve this complex problem (Hu et al., 2022; Pan et al., 2019). Sevveral studies have suggested more intricate algorithms such as Convolutional Neural



Networks (CNNs) and Recurrent Neural Networks (RNNs) to predict the network traffic (Liang et al., 2018; Oliveira et al., 2016; Nguyen & Ha, 2021; Yang et al., 2021). He et al. (2020) proposed the use of reinforcement learning to forecast short-term network traffic. Shi et al. (2020) employed optimization and disaggregation techniques to gain a comprehensive understanding of the problem. These models have demonstrated their capability in the evaluation of traffic flow and the management of congestion (Xing et al., 2022). Dai et al. (2008) have suggested to use network traffic prediction models with routing optimization. They have advocated the combination of two methods to increase the net efficiency, regulate resource allocation and improve service quality. Kundu et al. (2009) especially put an emphasis on the importance of categorization of network flows to improve the prediction models.

The objective and focus of this study are to develop an artificial intelligence model that makes real-time, effective and accurate predictions using network traffic data from a digital content provider. In the upcoming phases, this model will be used for predicting anomaly conditions in network traffic and optimizing resource allocation which will result in both minimization of cost and improving the user experience. The primary subject of the study is to understand how the network traffic of this provider changes and how to build a robust artificial intelligence model to predict the future direction of the network based on past network usage data.

## MATERIAL AND METHODS

### Material

The study collected data on network traffic from 13 different locations. We have used network traffic data from Acibadem location for model development. The data set includes four metrics of network traffic: traffic input volume and speed, output volume and speed. This study focuses on the traffic input volume feature in particular to develop the traffic prediction model.

### Methods

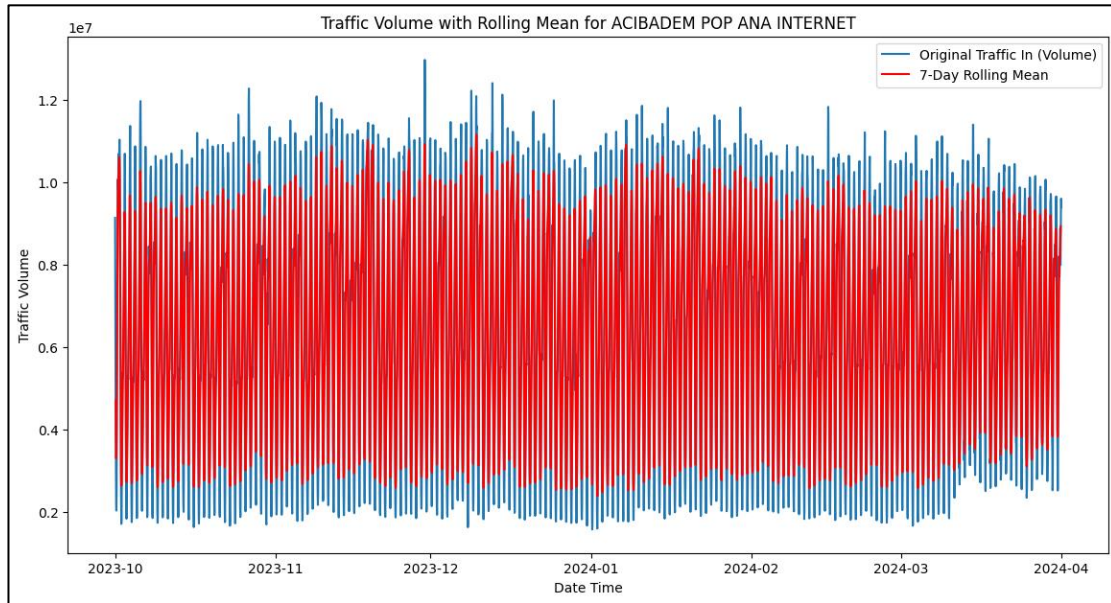
This project's methodologies involve time series analysis and machine learning techniques. The data collection was thoroughly analyzed before model development. Time series analysis is the examination of data points that were gathered, recorded, or seen over a period of time. The three essential methods used in model development are ARIMA (Autoregressive Integrated Moving Average), SARIMA (Seasonal Autoregressive Integrated Moving Average), and LSTM (Long Short-Term Memory), all of which are employed in this study.

#### *Data Preprocessing*

The data set contains 'Traffic In (volume)' data, which is collected every five minutes and aggregated to every hour. The data is prepared for time series analysis, and the 'Date Time' column is transformed to datetime format and indexed. Normalization was performed by scaling the data from 0 to 1 using MinMaxScaler. This procedure enhanced the model's learning process and made it easier to compare data on different scales. 80% of the 4,392 data points were assigned as training sets, with the remaining 20% used as test sets.

#### *Analysis of Network Traffic on Acibadem Location*

The Rolling Mean method was used to analyze network traffic data on the location of the pain and to understand data fluctuations and trends. Figure 1 shows the original network traffic volume in the blue line, and the 7-day moving average volume in the red line. Significant changes in network traffic volume can be seen over time. The volume seems to be changing on certain days and hours meaning the data has seasonality trends which plays an important role for the model development process.



**Figure 1.** Traffic volume with rolling mean for Acibadem location

### Model Development

In the model development process, we have used time series split cross validation to analyze the performance of the model to determine the best parameters for the final model. For all the models, we have used RMSE and  $R^2$  metrics to evaluate the model performance.

ARIMA was the first algorithm, we have implemented, which is a foundational model in time series analysis with its statistical characteristics and adaptability (Liu et al., 2016; Ugoh et al., 2022). The ARIMA algorithm has been applied in various domains, including economics, medicine, and hydrology (Luo et al., 2017; Huang et al., 2020; Gui et al., 2021).

In addition, we have incorporated the SARIMA method, a modified version of the ARIMA algorithm that considers the seasonal patterns in the time series (Galavi et al., 2013). The SARIMA algorithm is designed to identify cyclical patterns in time series data and commonly used in fields such as energy production or consumption and water level estimation (Hochreiter & Schmidhuber, 1997).

Ultimately, we employed the LSTM algorithm for the development of our model. The LSTM approach is a specific type of recurrent neural network (RNN) that is designed to identify and capture long-term dependencies within time series data (López et al., 2018). LSTM model is shown to reach successful implementations in many areas from wind power to internet traffic estimation (Bian et al., 2018).

## RESULTS

### ARIMA Model

The best model with ARIMA algorithm was reached with parameters (2, 1, 2). However, the RMSE value on the test data set was 0.229 and  $R^2$  was -0.02 which indicates that the model is far from explaining the time series.

### SARIMA Model

The SARIMA model is a more sophisticated time series model that also takes seasonal cycles into account. During model development work, the best model parameters were determined as (0, 0, 0) x (1, 0, 1, 24). The model produced a low RMSE value and a high  $R^2$  value in the training data set. The RMSE value in the test data set is 0.071, and the  $R^2$  value is 0.90. This shows that the model developed with the SARIMA algorithm can predict the incoming traffic volume with 90% accuracy.

### LSTM Model

The LSTM algorithm is a special RNN model specialized in time series with long-term cycles and

seasonal trends. The best performing model was found to have 8 neurons, 20 learning time, 8 batch size and 20% dropout ratio. The resulting model has a low RMSE and a high  $R^2$  value in the training set as well as the test data set. It has reached 0.047 in RMSE and 0.96 in  $R^2$ . This shows that the LSTM model can predict the incoming traffic volume with an accuracy of 96%.

### Model Comparison

Performance metrics of ARIMA, SARIMA and LSTM algorithms can be seen in Table 1. Lower RMSE and higher  $R^2$  values indicates that the model explains the time series with better accuracy. As seen in Table 1, the model developed with LSTM algorithm shows superior results in both metrics. In other words, the model using LSTM algorithm can predict incoming network traffic volume with high accuracy.

**Table 1.** Performance metrics of models

Model	RMSE	$R^2$
ARIMA	0.2296	-0.0199
SARIMA	0.0708	0.9029
LSTM	0.0468	0.9577

### DISCUSSION AND CONCLUSION

For this study we used ARIMA, SARIMA, and LSTM algorithms to develop a prediction model for input volume network traffic using data provided by a digital content provider. The performance results of the algorithms on the test data set showed that the LSTM model was superior to two models in predicting the incoming traffic volume. Thus, this study proposes LSTM algorithm as a successful methodology to explain network time series data. LSTM algorithm is thought to be superior because of its ability to explain longer-term relations within data and seasonal fluctuations. Low RMSE value and high  $R^2$  value of the model on the test data set indicate that the model can be used for network management.

The study presented a suitable model for predicting network traffic, a fundamental step in managing network traffic. The high-performance LSTM model is a pioneering study that can be used in many areas, such as strategic resource allocation, prediction of traffic congestion, and predetermination of anomalies that may occur in traffic. The enrichment of operating areas will enable optimization of network management, positively affecting user experience and helping to minimize costs.

In the next process, we will use multivariable time series analysis methods to further enhance the performance of the models. External data sources (weather conditions, public holidays, promotional activities, etc.) to be added to existing network traffic data are expected to further improve the performance. An anomaly detection model to be integrated into this prediction model will enable proactive measures to be taken and traffic to be managed more optimally.

### References

- Bian G, Li J, Lin W, 2018. Internet traffic forecasting using boosting LSTM method. *Destech Transactions on Computer Science and Engineering*, (csae). <https://doi.org/10.12783/dtcse/csae2017/17517>
- Dai L, Chang B, Cao Y, Cui Y, 2008. Integrating traffic estimation and routing optimization for multi-radio multi-channel wireless mesh networks. <https://doi.org/10.1109/infocom.2008.23>
- Galavi H, Mirzaei M, Shul L, Valizadeh N, 2013. Klang river-level forecasting using ARIMA and ANFIS models. *American Water Works Association*, 105 (9). <https://doi.org/10.5942/jawwa.2013.105.0106>
- Gui H, Wu Z, Zhang C, 2021. Comparative study of different types of hydrological models applied to hydrological simulation. *Clean - Soil Air Water*, 49 (8). <https://doi.org/10.1002/clen.202000381>
- He Q, Moayyedi A, Dán G, Koudouridis G, Tengkvist P, 2020. A meta-learning scheme for adaptive short-term network traffic prediction. *IEEE Journal on Selected Areas in Communications*, 38 (10): 2271-2283. <https://doi.org/10.1109/jsac.2020.3000408>
- Hochreiter S, Schmidhuber J, 1997. Long short-term memory. *Neural Computation*, 9 (8): 1735-1780. <https://doi.org/10.1162/neco.1997.9.8.1735>



- Hu H, Kang Q, Zhao S, Wang J, Fu Y, 2022. Chaotic prediction of network traffic based on support vector machine optimized by improved beetle swarm optimization algorithm. <https://doi.org/10.1117/12.2657090>
- Huang Y, Xu C, Ji M, Xiang W, He D, 2020. Medical service demand forecasting using a hybrid model based on ARIMA and self-adaptive filtering method. *BMC Medical Informatics and Decision Making*, 20 (1). <https://doi.org/10.1186/s12911-020-01256-1>
- Kundu S, Pal S, Basu K, Das S, 2009. An architectural framework for accurate characterization of network traffic. *IEEE Transactions on Parallel and Distributed Systems*, 20 (1): 111-123. <https://doi.org/10.1109/tpds.2008.47>
- Liang Y, Cui Z, Tian Y, Chen H, Wang Y, 2018. A deep generative adversarial architecture for network-wide spatial-temporal traffic-state estimation. *Transportation Research Record Journal of the Transportation Research Board*, 2672 (45): 87-105. <https://doi.org/10.1177/0361198118798737>
- Liu C, Hoi S, Zhao P, Sun J, 2016. Online ARIMA algorithms for time series prediction. *Proceedings of the AAAI Conference on Artificial Intelligence*, 30 (1). <https://doi.org/10.1609/aaai.v30i1.10257>
- López E, Allende H, Gil E, Madsen H, 2018. Wind power forecasting based on echo state networks and long short-term memory. *Energies*, 11 (3): 526. <https://doi.org/10.3390/en11030526>
- Luo L, Luo L, Zhang X, He X, 2017. Hospital daily outpatient visits forecasting using a combinatorial model based on ARIMA and SES models. *BMC Health Services Research*, 17 (1). <https://doi.org/10.1186/s12913-017-2407-9>
- Mao G, 2005. A timescale decomposition approach to network traffic prediction. *IEICE Transactions on Communications*, E88-B (10): 3974-3981. <https://doi.org/10.1093/ietcom/e88-b.10.3974>
- Nguyen L, Ha T, 2021. A novel approach of traffic density estimation using CNNs and computer vision. *European Journal of Electrical Engineering and Computer Science*, 5 (4): 80-84. <https://doi.org/10.24018/ejece.2021.5.4.353>
- Oliveira T, Barbar J, Soares A, 2016. Computer network traffic prediction: a comparison between traditional and deep learning neural networks. *International Journal of Big Data Intelligence*, 3 (1): 28. <https://doi.org/10.1504/ijbdi.2016.073903>
- Pan X, Zhou W, Lu Y, Sun N, 2019. Prediction of network traffic of smart cities based on DE-BP neural network. *IEEE Access*, 7: 55807-55816. <https://doi.org/10.1109/access.2019.2913017>
- Shi J, Leau Y, Li K, Park Y, Zhou Y, 2020. Optimization and decomposition methods in network traffic prediction model: a review and discussion. *IEEE Access*, 8: 202858-202871. <https://doi.org/10.1109/access.2020.3036421>
- Sun S, Zhang C, Yu G, 2006. A Bayesian network approach to traffic flow forecasting. *IEEE Transactions on Intelligent Transportation Systems*, 7 (1): 124-132. <https://doi.org/10.1109/tits.2006.869623>
- Tebaldi C, West M, 1998. Bayesian inference on network traffic using link count data. *Journal of the American Statistical Association*, 93 (442): 557. <https://doi.org/10.2307/2670105>
- Ugoh C, Echebiri U, Temisan G, Iwuchukwu J, Guobadia E, 2022. On forecasting Nigeria's GDP: a comparative performance of regression with ARIMA errors and ARIMA method. *International Journal of Mathematics and Statistics Studies*, 10 (4): 48-64. <https://doi.org/10.37745/ijmss.13/vol10n44864>
- Wang J, Xiao X, 2006. An analysis of traffic load prediction base on auto regressive model in small time granularity. <https://doi.org/10.1109/icccas.2006.285007>
- Xing X, Li X, Zhai Y, 2022. GRU-CNN neural network method for regional traffic congestion prediction serving traffic diversion demand. *Wireless Communications and Mobile Computing*, 2022: 1-18. <https://doi.org/10.1155/2022/8164105>
- Yang Q, Zhong T, Zhang F, 2021. Traffic speed forecasting via spatio-temporal attentive graph isomorphism network. <https://doi.org/10.1109/icassp39728.2021.9414596>

#### **Acknowledgment**

This study was conducted as a part of a project in the Research & Development Center in D-Smart Inc.

#### **Conflict of Interest**

The authors have declared that there is no conflict of interest.

## Exploring Newborn Screening Results Data: Advanced Statistical and Machine Learning Techniques for Risk Detection

Gözde Filiz<sup>1\*</sup>, Aret Tatonyan<sup>2</sup>, Gülden Gökçay<sup>3</sup>, Mehmet Cihan Balcı<sup>3</sup>, Tuna Çakar<sup>4</sup>

<sup>1</sup>MEF University, Graduate School of Science and Engineering, 34396, Istanbul, Türkiye

<sup>2</sup>NETIX Bilişim Teknolojileri, 34750, Istanbul, Türkiye

<sup>3</sup>Istanbul University, Istanbul Medical Faculty, Division of Pediatric Nutrition and Metabolism, 34093, Istanbul, Türkiye

<sup>4</sup>MEF University, Department of Computer Engineering, 34396, Istanbul, Türkiye

\*Corresponding author e-mail: cakart@mef.edu.tr

### Abstract

*Timely detection of metabolic disorders, such as methylmalonic acidemia, is vital in newborn screening testing. This study investigates a supportive model that uses artificial intelligence methods for the analysis of newborn screening tests, specifically targeting the identification of individuals who may have a greater likelihood of being at risk. The collection comprised 1,554 records, with each record representing the results of a unique newborn screening test. Among them, 21 cases were determined to be examples of methylmalonic acidemia, whereas the rest of the cases were undiagnosed. We utilized a variety of biochemical indicators, including arginine, carnitines, and amino acids like valine and methionine. We conducted an inquiry utilizing histogram analysis to comprehend the attributes of the distribution, heat maps for correlation analysis to identify connections between variables, and the Predictive Power Score to examine correlations that may be utilized for making predictions. The histogram analysis showed that the distribution of most biomarkers was positively skewed, suggesting a low risk for most newborns but an elevated risk for a minority. The correlation analyses demonstrated strong positive associations as well as substantial negative correlations, emphasizing the intricate connections among the biomarkers. Subsequently, clustering methods like K-Means, Hierarchical Clustering, and Gaussian Mixture models were employed to detect patterns and distributions of subgroups. The clustering analysis demonstrated that disease labels were dispersed within these groups, suggesting the existence of differences in metabolic profiles. Anomaly detection methods, such as the Local Outlier Factor and the One Class SVM, were employed to identify anomalies, which may indicate the presence of undiscovered risk factors. The Local Outlier Factor algorithm accurately classified 90% of diagnosed cases as anomalies. Furthermore, it categorized 137 unlabeled occurrences as anomalies. Performance of anomaly detection algorithms shows that machine learning techniques can enhance the precision of newborn screening systems. Furthermore, these discoveries can be incorporated into real-world implementations. Subsequent investigations will prioritize the enlargement of the dataset and the enhancement of the models to augment the precision of diagnosis.*

**Keywords:** Newborn Screening, Machine Learning, Clustering, Anomaly Detection, Predictive Analysis.

### INTRODUCTION

Newborn screening tests are utilized to detect genetic or metabolic disorders that are imperative to discover in the early stages. Prompt identification and medical intervention for these medical conditions significantly contribute to the healthy growth and well-being of the child. The tests are employed shortly after the infants are born and prevent significant health problems that can leave irreparable damage if not diagnosed and treated. Common illnesses that can be identified by newborn screening tests include Phenylketonuria (PKU), Congenital Hypothyroidism, Galactosemia, Oral Cell Disease, Methylmalonic Acidemia, Biotinidase Deficiency, Cystic Fibrosis, and Congenital Adrenal Hyperplasia (CAH). It is important to improve the newborn screening systems with supporting processes to increase the precision of identifying newborns who are at greater risk of these diseases. Newborn screening tests enable early detection, which not only allows for prompt intervention but also has a significant impact on the effectiveness of treatment for curable illnesses in newborns (Varier et al., 2015; Guillory et al., 2017).



Studies have shown that machine learning algorithms can enhance newborn screening systems by leveraging pattern recognition capabilities (Peng et al., 2020; Chen et al., 2013; Peng et al., 2020). By utilizing pattern and anomaly detection techniques on screening test results, these algorithms enhance the precision and effectiveness of identifying risk groups. Anomaly detection algorithms have the ability to identify patterns in data that may indicate unknown risks in infants (Colgan et al., 2012; Kemper et al., 2011). The primary aim of our work is to develop an artificial intelligence model that can be used as a supportive function in the analysis of newborn screening results which can identify the individuals who have not been diagnosed yet or have a high level risk.

## MATERIAL AND METHODS

### Material

The data set used in this study contains the scan results of the newborns. After removing columns and rows containing missing data from the data set, the study continued with 1,554 rows of data. Each line represents the newborn test result of an individual. Newborn screening test results include amino acids, carnitines and other recordings that are used to evaluate the various metabolic and genetic conditions of newborns. In this data set, 21 lines show the test results of individuals diagnosed with methylmalonic acid. We have created a new feature as 'Patient Label' to flag these diagnosed patients in the data set. The remaining 1,533 individuals are uncertain whether they are ill or not.

### Methods

We have used multiple approaches to analyze the data set. We have conducted histogram analysis to comprehend the distributions of features within the data. This analysis represented distributions of the features offering insights for overall data. We have implemented correlation analysis and heat maps to enhance the understanding of interrelationships among features. We have also used Predictive Power Score (PPS) which quantifies the ability of features to predict one another. PPS is particularly effective at understanding non-linear correlations in the data set.

#### *Data Preprocessing*

Before starting the analysis and model development phases, we have preprocessed the data. First we have cleaned out missing or incorrect data. We have created 'Patient Label' feature to flag the diagnosed patients. Lastly, we have normalized the data set to improve the accuracy and effectiveness of the analyses.

#### *Clustering Models*

We have used clustering algorithms over the data set to see the distribution of the 'Patient Label' along the other data points. Prior to the clustering algorithms, we have implemented silhouette analysis to determine the optimal number of clusters. The K-Means algorithm was used in the first model development work, and the Gaussian Mixture and Hierarchical Accumulation algorithms were used in preliminary model work.

#### *Anomaly Detection Models*

Various anomaly detection techniques have been applied to identify potential anomalies and risk groups in the data set. Models were developed using Local Outlier Factor, Robust Covariance, Isolation Forest and One Class SVM algorithms.

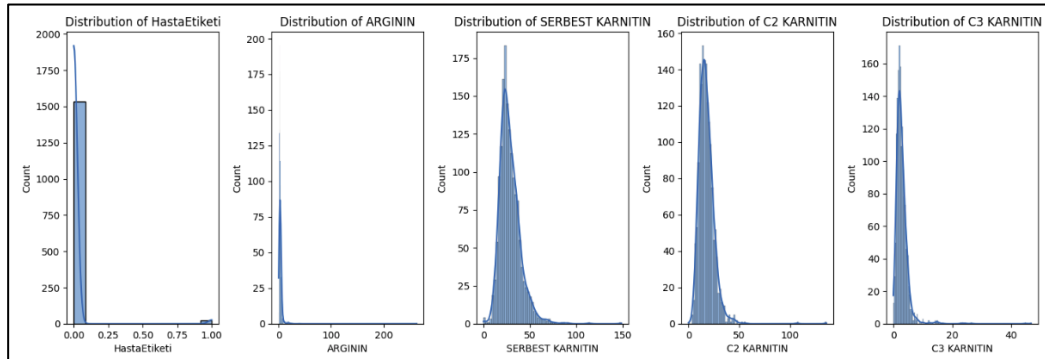
## RESULTS

The attributes were examined using a histogram and were typically found to exhibit a right-skewed distribution. This suggests that the data distribution is skewed towards higher values. A positive distribution signifies that the majority of the dataset consists of values that are below the average, with only a few observations having higher values. These findings align with the outcomes of newborn screening tests, indicating that a large number of people have a low risk, whereas only a small number have a high risk. For instance, in the case of the 'Free Carnitine' variable, a distribution skewed to the right suggests that the majority of babies fall within the usual range, while a few may be at a higher risk. Figure 1 displays the outcomes of the histogram analysis. The histogram analyses were repeated,



considering the differentiation based on the 'Patient Label'. While the overall label ratio was low in the entire dataset, variations in distribution were noted in certain characteristics, such as C14 Carnitine and C16-1 Carnitin.

A thermal map showing the correlations between the attributes has been created. The colors on the map represent the correlation coefficients. On the thermal map, a high positive correlation has been observed between some attributes. For example, many properties have high positive correlations with a few others, which suggests that there is a linear relationship between properties. Some attributes have found low or negative correlations. This may indicate that the attributes are inadequate in predicting each other, which is a positive situation for the model because the characteristics that provide different information can include different perspectives of the model. Characteristics such as C3 and C5-OH carnitine have been found to be associated with the "Patient Label".



**Figure 1.** Example results of histogram analysis

In the analysis using the Predictive Power Score (PPS) method, no characteristics were clearly identified in the direct estimation of the 'Patient Label' variable, but some variables (C3 carnitine, C16 carnitine, Glycine, Glutamate) were associated.

As a result of Silhouette Analysis, it was decided to use 7 clusters in model studies. The first model development study used the K-Means algorithm, and it was seen that the "Patient Label" spread across clusters. Similar results have been obtained with hierarchical cumulation and Gaussian Mixture algorithms.

As shown at Table 1, the results of the anomaly detection algorithms, it was found that the Local Outlier Factor algorithm marked 90% of the lines in the data set that were labelled as patients as anomalies. (-1 indicates the anomaly case). In addition, another 137 lines have been marked as anomalies. Other algorithms have shown similar performance, but at low rates. The fact that the patient's label is 0 in the data set does not mean that the person does not have the disease, it simply means that he has not been diagnosed. Taking this into account, the model has been assessed as promising.

**Table 1.** Results of Local Outlier Factor algorithm

Patient Label	Local Outlier Factor		Total
	-1	1	
0	137	1396	1533
1	19	2	21
Total	156	1398	1554

## DISCUSSION AND CONCLUSION

Our research has shown that data analysis techniques used in newborn screening tests can be effective, in risk detection. The distribution analysis of the properties showed a positive impact distribution, which was consistent with the results of the newly born scanning tests. Most newborns have been observed to be at low risk, but only a few are at high risk.

Correlation analyses have indicated a strong positive link between specific qualities. This implies that specific metabolic elements collaborate and could be significant in the identification of particular

illnesses. Analysis using the Predictive Power Score (PPS) has indicated that there is no single feature that can accurately predict the "Patient Label" variable. However, there are certain variables that have a relationship with it. This implies that the utilization of more intricate and interactive models could enhance the performance of the model.

Results of clustering algorithms have shown that there are different groups in the data set where the diagnosed patients are distributed among. These analyses are needed to be reproduced with larger data sets since these groups can be used to determine the risk of the disease. K-Means, Hierarchical Aggregation, and Gaussian Mixture algorithms have resulted in similar groups and patterns. Local Outlier Factor algorithm among other anomaly detection algorithms has produced accurate results in identifying already diagnosed individuals with a ratio of 90%. The model has identified certain individuals as anomalies who have not been diagnosed. These results are linked to the screening test systems, as some at-risk groups may not have been identified yet. Therefore, further analysis is required to examine these results, as these individuals may be at a high risk of disease.

This study underlines the significance of creating support systems that are equipped with artificial intelligence techniques to analyze the newborn screening test results. Our study shows that employing machine learning and statistical analysis methods can be effective in identifying metabolic and genetic disorders. Our future research will focus on enhancing the overall reliability of our findings by using larger and more diverse data sets. Implementing these support systems could enhance the efficiency of newborn screening strategies in global health systems and result in substantial enhancements in children's health.

## References

- Chen, W., Hsieh, S., Hsu, K., Chen, H., Su, X., Tseng, Y., ... & Lai, F. (2013). Web-based newborn screening system for metabolic diseases: machine learning versus clinicians. *Journal of Medical Internet Research*, 15(5), e98. <https://doi.org/10.2196/jmir.2495>
- Colgan, S., Gold, L., Wirth, K., Ching, T., Poulakis, Z., Rickards, F., ... & Wake, M. (2012). The cost-effectiveness of universal newborn screening for bilateral permanent congenital hearing impairment: systematic review. *Academic Pediatrics*, 12(3), 171-180. <https://doi.org/10.1016/j.acap.2012.02.002>
- Guillory, C., Gong, A., Livingston, J., Creel, L., Ocampo, E., & Mckee-Garrett, T. (2017). Texas pulse oximetry project: a multicenter educational and quality improvement project for implementation of critical congenital heart disease screening using pulse oximetry. *American Journal of Perinatology*, 34(09), 856-860. <https://doi.org/10.1055/s-0037-1599214>
- Kemper, A., Mahle, W., Martin, G., Cooley, W., Kumar, P., Morrow, W., ... & Howell, R. (2011). Strategies for implementing screening for critical congenital heart disease. *Pediatrics*, 128(5), e1259-e1267. <https://doi.org/10.1542/peds.2011-1317>
- Peng, G., Tang, Y., Cowan, T., Enns, G., Zhao, H., & Scharfe, C. (2020). Reducing false-positive results in newborn screening using machine learning. *International Journal of Neonatal Screening*, 6(1), 16. <https://doi.org/10.3390/ijns6010016>
- Variar, R., Jensen, M., Adams, C., & Book, L. (2015). Neonatal cholestasis caused by undiagnosed maternal Graves' disease. *ACG Case Reports Journal*, 2(1), 58-60. <https://doi.org/10.14309/crj.2014.85>

## Acknowledgment

This study was conducted with the grant by TÜBİTAK-TEYDEB 1507.

## Conflict of Interest

The authors have declared that there is no conflict of interest.

**About Problems and New Approaches in the Theory and Methodology of Forming a Management System for State Development Programs in Conditions of Economy Transformation into Innovation - Statistical Research**

**Mafura K. Uandykova<sup>1</sup>, Anel D. Yeleukulova<sup>1</sup>, Assel D. Yeleukulova<sup>1</sup>, Gulnar S. Mukhamedzhanova<sup>1</sup>**

<sup>1</sup>Narxoz University, Almaty, Republic of Kazakhstan

This research was funded by the Science Committee  
Ministry of Science and Higher Education of the Republic of Kazakhstan  
(grant No. IRN AP19678174)

**Abstract**

*This study delves into the critical issues surrounding state planning and management, aiming to provide insightful analysis and viable solutions. Drawing on comprehensive reviews of both domestic and international experiences in project management, the study establishes that the adoption of project management technologies, particularly in the guise of national projects, falls short of realizing the envisaged outcomes. To effectively address the challenge of transitioning the economy towards innovation, the study puts forth general approaches for a novel methodology in the conception and execution of state development programs.*

*Methodology* The study employs a robust methodology encompassing substantive, retrospective, and comparative analyses of documents within the realm of the state planning system. It integrates contemporary theories of economic systems, information economics, and their practical applications for managing socio-economic systems, alongside methods of economic and mathematical modeling, as well as the principles of developing decision support systems, program, and project management.

*Novelty and Research Findings* The research's novelty lies in the development and augmentation of the theory and methodology for establishing a system to manage state development programs amidst the transformation of the economy into an innovative one. The study concludes that a systematic view of the state planning and management system is currently lacking. Furthermore, the shift to project management methods, as exemplified by national projects, fails to yield anticipated results, potentially hindering the attainment of the objectives of state development programs and national projects aimed at fostering a competitive and innovative economy through diversification. The authors advocate for a scientifically-grounded approach to addressing this systemic issue, proposing a new methodology for the formulation and implementation of state development programs integrated with an intelligent decision support system.

**Keywords:** *Innovative Economy, Economic Transformation, State Development Programs, Management, Problems of Formation and Implementation of Development Programs, Development Model, Program and Project Management.*

**Introduction**

The transformation of an economy into an innovative one is a multifaceted endeavor driven by a confluence of factors, substantiated by examples and insights gleaned from the experiences of developed nations. This transformation is underpinned by the overarching goal of bolstering competitiveness in the global economy through economic diversification, fostering sustainable economic growth, and creating meaningful employment opportunities. Furthermore, it is propelled by the imperative to attain economic sustainability and development, all converging to contribute to an enduring enhancement in the well-being of the populace.

The challenges in managing state development and economic programs are glaringly apparent when scrutinizing the operational outcomes of the economy. This is vividly exemplified by the Economic Complexity Index (ECI), a crucial metric calculated using the Hausman and Hidalgo method and disseminated by Harvard University, which serves as a pivotal barometer of economic development, encompassing the Kazakh economy.



V. INTERNATIONAL APPLIED STATISTICS CONGRESS (UYIK - 2024)  
 İstanbul / Türkiye, May 21-23, 2024

As of the 2021 ranking, Kazakhstan is positioned at 88th place with an ECI of -0.47, signifying the prevalence of a raw material-centric economy, as indicated by the predominance of goods marked in brown, denoting their association with the extractive sector (Figure 1).

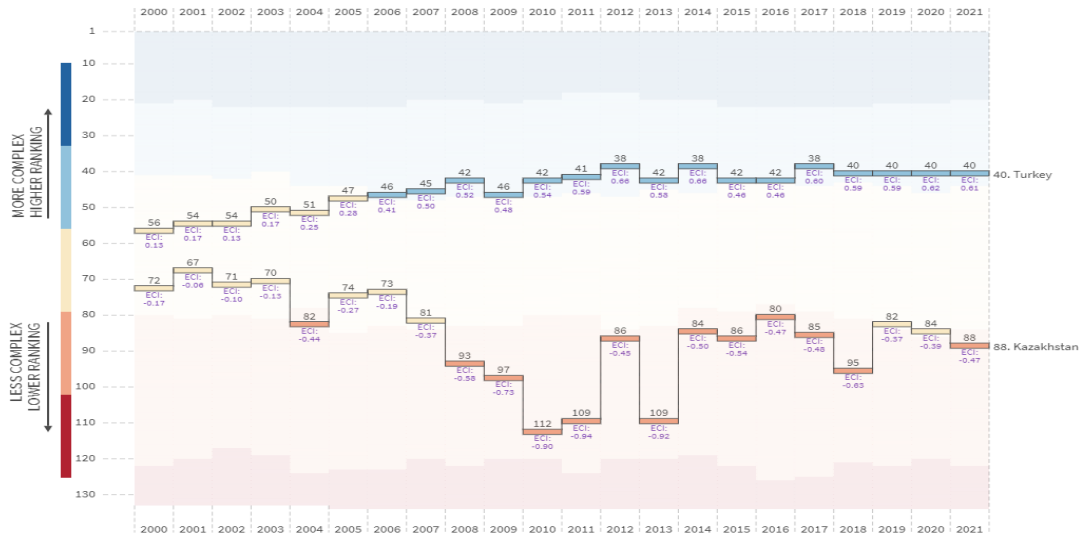


Figure 1. Place of Kazakhstan in the Atlas of Economic Complexity (133 countries)

Source: <https://atlas.cid.harvard.edu/rankings>

Comparative dynamics in the Atlas of Economic Complexity underscore Kazakhstan's unfavorable standing in contrast to its neighboring countries, characterized by a lack of commodity diversification, geographical placement within the commodity export zone, and significant isolation of Kazakhstani products from each other, indicative of underutilized potential for co-exportation. This decline in complexity persists despite efforts to diversify exports, necessitating a strategic pivot towards the development of manufacturing exports, deemed indispensable for Kazakhstan's sustained economic growth.

Furthermore, Kazakhstan's 81st ranking in the 2023 Global Innovation Index (GII), a rise from the 79th position in 2019, underscores the pivotal role of innovation and technology exports in enhancing economic complexity. The integrated assessment of the Economic Complexity Index based on trade, technology export, and research indicators accentuates the pressing need for substantial advancements in Kazakh science (Figure 2).

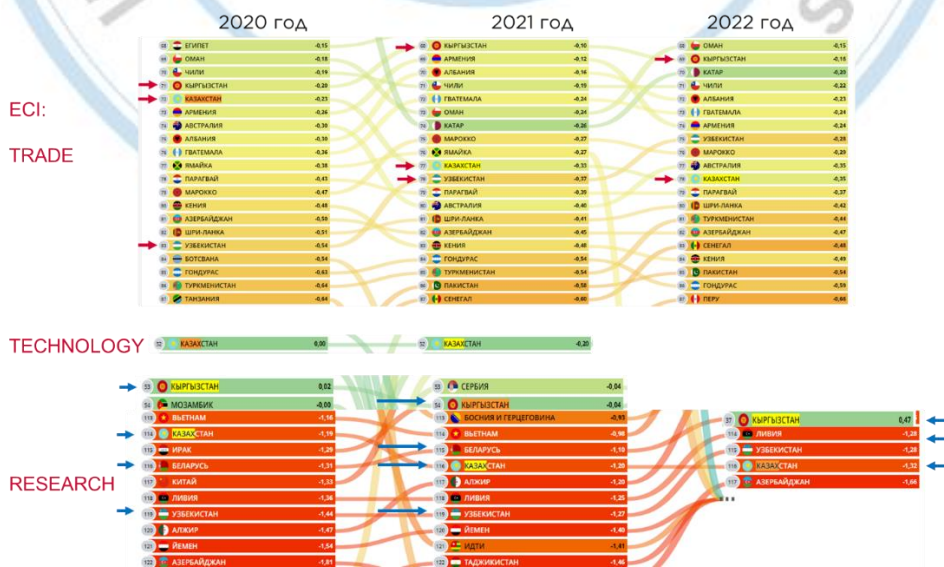


Figure 2. The Economic Complexity Index is assessed in an integrated manner based on three indicators: Trade, Technology Export and Research

Source: <https://oec.world/en/rankings/eci/hs6/hs96?tab=ranking>

Consequently, the government's heightened focus on bolstering research and development through diverse research grants signals a concerted effort to address the challenges outlined by the ECI assessment.

### Main part

The research conducted by our team has unveiled several theoretical and methodological problems in the management, formation, and implementation of State Programs (SP) and National Projects (Figure 3).

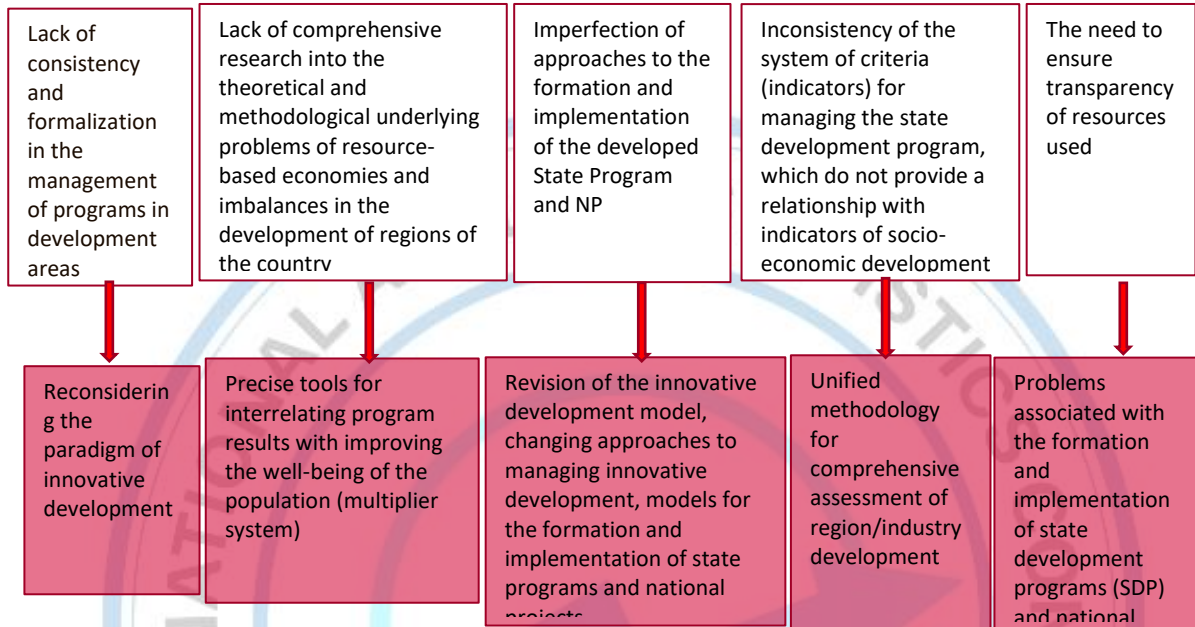


Figure 3. Problems associated with the formation and implementation of state development programs and national projects/

Source: Developed by the authors

These issues include:

1. Lack of consistency and formalization in program management: There is a noticeable absence of a cohesive and formalized approach to managing programs in development areas.
2. Shortage of comprehensive research into theoretical and methodological problems of resource-based economies: The inadequacy of in-depth research into the underlying issues pertaining to resource-based economies and disparities in economic development has been observed.
3. Imperfections in approaches to program formation and implementation: The methodologies employed in the formation and execution of developed SP are found to be imperfect and warrant improvement.
4. Inconsistency in criteria for the management of intellectual property: The existing system of criteria (indicators) for managing intellectual property lacks coherence with indicators of socio-economic development, highlighting the need for alignment.
5. Transparency of resource utilization: There is a need to ensure transparency in the utilization of resources.

These conclusions have led to the hypothesis that a fundamental revision of the paradigm of innovative development, IR models, mathematical formulation of goals, and measurable results for the formation and implementation of development programs is imperative. Consequently, enhancing management tools to facilitate the formation and implementation of development programs based on these revised tools becomes crucial.

An essential aspect for effectively leveraging resources is the utilization of economic, financial, and human resource productivity as indicators of innovative development. These components, along with corresponding multipliers, determine the growth trajectory in the space of the three-directional vector of innovation. The coordination of these indicators is achieved through the third multiplier - socio-political progress, logically the product of the first two multipliers.

The methodology for calculating the multiplier system was tested on data from the economy of Kazakhstan and the resulting system of three multipliers was depicted in Figure 4-5. Analysis of these multipliers and resource productivity reveals that solely relying on the basic technical and technological model of innovative development leads to decreased well-being of the population and low resource productivity. This underscores the necessity of introducing innovations in all three directions.

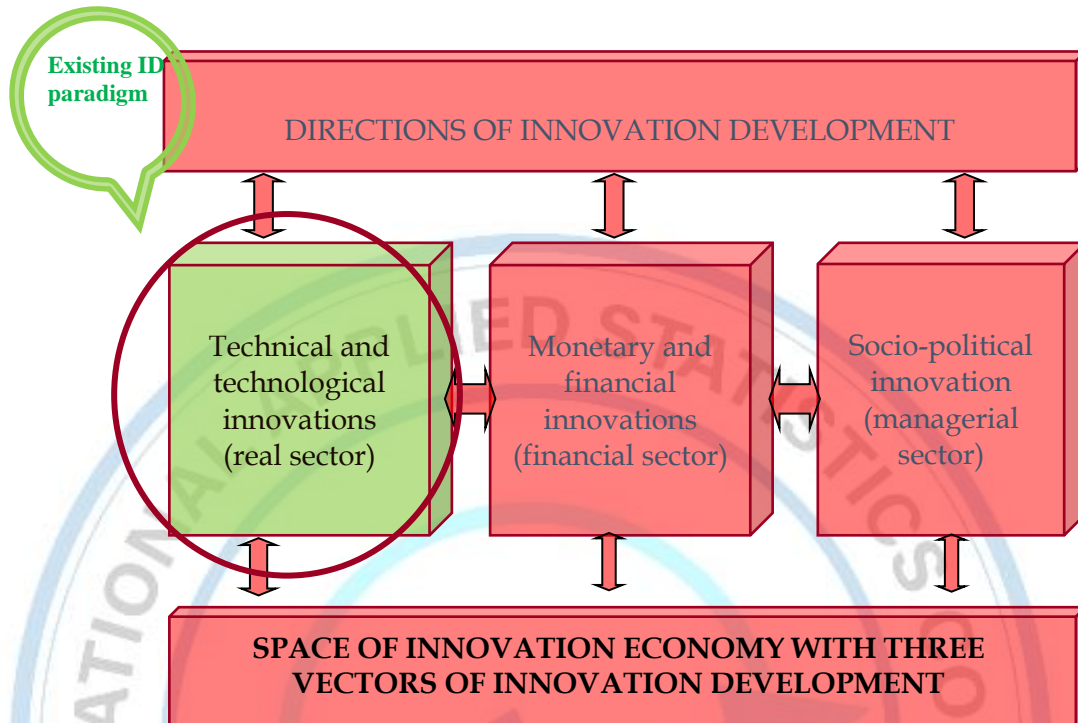


Figure 4. A new development paradigm in the transformation of the economy into innovation  
 Source: Developed by the authors

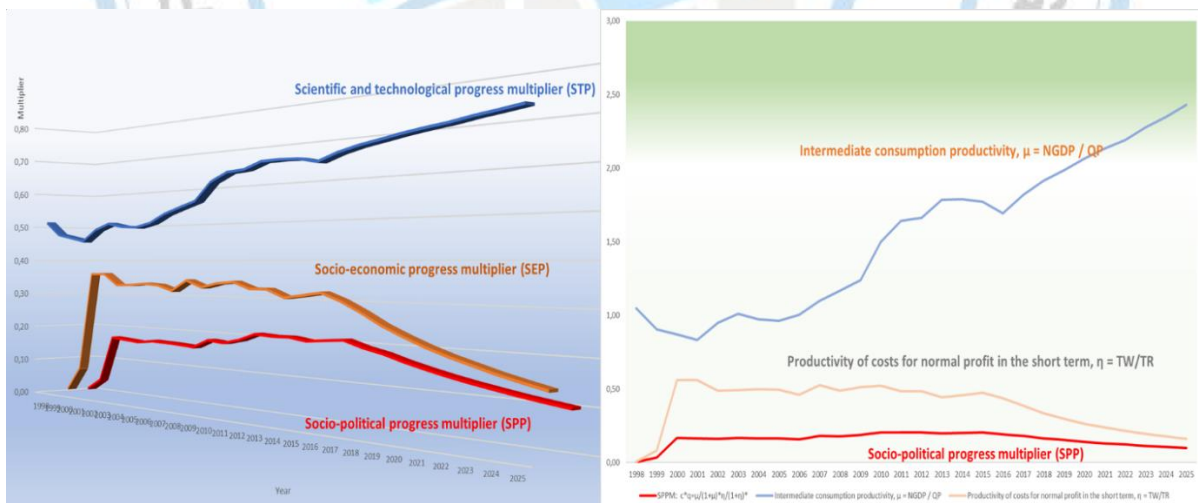


Figure 5. Comparative diagram of resource multipliers and productivity  
 Source: Developed by the authors According to the Statistics Agency of the Republic of Kazakhstan

The utilization of a management criteria system based on three multipliers provides a versatile means to evaluate and compare the economies of various countries without the need to standardize development results into a common monetary equivalent. This eliminates the duality in measuring the value of national currencies, fostering a more accurate assessment of economic development trajectories. The system of multipliers not only enables the determination of the direction of economic growth but also facilitates comparative analyses of countries' development.



In examining the experiences of developed countries in ensuring transparency in the implementation of national projects, the Canadian Project Navigator system emerges as a robust framework designed to standardize project management. Structured into five distinct stages, each with corresponding gates representing decision points, the Project Navigator promotes consistency, transparency, and accountability across all projects, fostering effective communication among project management professionals.

Furthermore, in the form of a modern support tool, we offer information and analytical support for the formation and implementation of state development programs - the Decision Support System (DSS). This DSS is characterized by a structural-functional model with a modular architecture, reflecting the functions of key subsystems that implement innovative economic development programs. It includes environmental, process, project-based, and object-based subsystems, each serving specific functions integral to the successful implementation of development programs and national projects.

In addition to the technological support, it's imperative to address the evolving professional landscape and the changing needs of specialists. Proficiency in modern approaches and tools for project management, along with familiarity with the code of practice/standard of the Project Management Institute (PMI), is becoming increasingly essential. Project-based learning can equip students with the ability to apply project management principles in real-world scenarios, ultimately enhancing their capacity to learn and apply the principles outlined in the PMI Code of Practice.

### Conclusion

In conclusion, it is evident that project planning and management play a pivotal role in the successful implementation of initiatives that have a substantial impact on the state as a whole. Moving towards a new paradigm of innovative development is vital for accurately assessing a country's development trajectory and achieving the goal of transforming the economy into an innovative one. The application of project management principles is not only feasible but also highly beneficial for the successful implementation of national projects, underscoring the importance of effective project management in driving impactful initiatives at the national level.

### References

1. Lazarova, L., Kairova, F., Abaeva, E., Bibilova, N., & Savlokhova, V. Program-Target Method Of Budget Resources Management In Social Development Of The State. In I. V. Kovalev, A. A. Voroshilova, & A. S. Budagov (Eds.), *Economic and Social Trends for Sustainability of Modern Society (ICEST-II 2021)*, vol 116. European Proceedings of Social and Behavioural Sciences (pp. 352-358). European Publisher. – DOI: 10.15405/epsbs.2021.09.02.38
2. Furlinger, Karl. OpenMP Application Profiling - State of the Art and Directions for the Future // *Procedia CS*. 2010. - 1. 2107-2114. 10.1016/j.procs.2010.04.236.
3. M. Tudruj and L. Masko, "Program execution control for communication on the fly in dynamic shared memory processor clusters," *Proceedings. International Conference on Parallel Computing in Electrical Engineering*, Warsaw, Poland, 2002, pp. 15-20, doi: 10.1109/PCEE.2002.1115190.
4. Wan Abdul Aziz, Wan Noor Hayatie & Aziz, Rossidah & Shuib, Adibah & Razi, Faedah. The relationship between budget allocated and budget utilized of faculties in an academic institution. 2014. - 1602. 580-586. 10.1063/1.4882543.
5. M. Aubry, S. Lenfle. Projectification: Midler's footprint in the project management field // *International Journal of Managing Projects in Business* / 2012. - 5(4):680-694.- DOI:10.1108/17538371211268997
6. Fred, M., & Godenhjelm, S. (Eds.) (). *Projectification of Organizations, Governance and Societies: Theoretical Perspectives and Empirical Implications* // Palgrave Macmillan. - 2023. – URL: <https://doi.org/10.1007/978-3-031-30411-8>

**Classification of Cherry Producers' Problems in Production (Tokat Central District Example)**

**Ufuk YILDIRIM<sup>1\*</sup>, Rüveyda YÜZBAŞIOĞLU<sup>1</sup>**

<sup>1</sup> Gaziosmanpaşa University, Agriculture Faculty, Agricultural Economics Department, 6100, Tokat, Türkiye

\*Corresponding author e-mail: ufukyildirim60@gmail.com

**Abstract**

*In this research, it was aimed to determine the problems experienced by cherry producers in the regions of the central district of Tokat province. For this purpose, 85 cherry producers were interviewed. Manufacturers' problems in production were tried to be measured with a 5-point Likert scale. As a result of the reliability test of the variables, Cronbach's Alpha Value was found to be 0.834. The production problems experienced by the producers were tried to be determined as 27 variables. The problems of producers in production were grouped under 7 variables by factor analysis. The problems of producers in production are grouped under the headings: Input costs, producer awareness, labor shortage, credit use, production inadequacy, risk-uncertainties and marketing problems. It has been observed that producers are close to the upper limit of the active working age limit (average age of 51.69) and their education level is at primary school level. In other words, as a result of the research, it can be said that manufacturers who do not fight with innovations due to education and knowledge, although they are seen as experienced with age, have problems parallel to the problems that have not been solved for years. In Tokat province, which is important in agriculture, it may be recommended to develop policies for generalization in the producer portfolio as well as support for producers. Additionally, supports for agricultural education can be applied in education.*

**Keywords:** Cherry, Production, Problem, Factor Analysis

**INTRODUCTION**

According to FAO 2022 data, cherry production in the world is carried out in 64 countries on a total area of 454,664.00 hectares. It can be said that Turkey has the largest cherry cultivation area, with 17.38% of the world's cherry production area being made in Turkey (80,482.00 ha). When the countries that make up 50% of the world cherry cultivation area are examined respectively; Turkey (17.38%), Chile (13.30%), USA (7.39%), Syrian Arab Republic (6.62%) and Spain (6.33%).

When examined in terms of cherry production amount, according to FAO 2022 data, a total of 2,765,827.38 tons of cherries are produced in the world. In Turkey, 656,041.00 tons of cherry production is produced in the field. In other words, Türkiye is the country that produces the most cherries in the world, producing 23.72% of the world's cherry production. When examined respectively, the countries that produce 50% of the world's cherry production are Turkey (23.72%), Chile (16.02%), Uzbekistan (7.84%) and the USA (7.60%).

While Turkey ranks first in terms of world cherry production and cultivation area, when evaluated in terms of yield, it is calculated that a total of 60,832 tons of cherries are taken from one unit area, while the world average is 60,832 tons. Türkiye, which has a yield above the world average, ranks 13th in the world cherry yield. When the world cherry yield per unit area is examined, Guyana with 516,461 tons, Austria with 281,481 tons and Suriname with 275,267 tons are the leading countries.

According to TURKSTAT 2023 data, 21,815.00 tons of cherry production was made in an area of 13,277.00 hectares in Tokat. When a 2022/2023 comparison is made for Tokat province, that is, when the cherry cultivation area and production amount in the previous year are examined, 21,815 tons of cherries were collected from an area of 13,277 ha in 2022, while 21,547 tons of cherries were collected from an area of 14,748 ha in 2023. When comparing two years here, the production area in Tokat province increased by 10% compared to the previous year, while the production amount decreased by approximately 2%. This indicates that there is a problem with production.

This research was conducted with the question of what are the production problems of cherry producers in Tokat province, located in the middle belt of Turkey, which is the world leader in terms of

world cherry production, and whether we can classify their problems and make permanent suggestions for future plans.

In the first part of the research, the demographic structures of the producers are revealed, in the second part, general information about the producers regarding cherry production is given, and in the last part, the problems faced by the producers in production and their classification are given.

## MATERIAL AND METHODS

### Material

The material of this research was created by the data obtained through a survey from the producers producing cherries in the central district of Tokat province between June and August 2022.

### Methods

#### *The Collection of the Data*

83 randomly selected cherry producers were interviewed using the Newbold (1995) sampling method (calculated with a 90% confidence interval and a 5% margin of error).

#### *Statistical Analysis*

In this research, to determine the problems experienced by producers producing cherries in the villages of the central district of Tokat province, a 5-point Likert scale was used (1 being "strongly disagree", 2 being "disagree", 3 being "undecided", 4 being "agree", 5 being "strongly agree").") was used (Yin et al., 2014). Factor analysis was used to separate the production problems of cherry producers into fewer factor loads. Factor analysis is a type of multivariate statistical analysis that provides a more meaningful and summary presentation of data based on the relationships between variables (Ness, 2000; Kurtuluş, 2004; Tekin, 2007; Karpati and Szakal, 2009).

## RESULTS

It is known that not only the producer information but also the socio-demographic characteristics of the producer are effective in production. Therefore, some demographic characteristics of cherry producers are examined in Table 1. It has been calculated that the average age of cherry producers is 52 years, they have been farming for approximately 32 years and have been engaged in cherry production for 22 years. It was determined that the majority of cherry producers in Tokat center (39.76%), as in Turkey in general, were primary school graduates. However, the fact that 25% of the producers are high school graduates may be an indication that the education level is not too low.

**Table 1.** Some demographic characteristics of producers

Group and Description		Frequency	%	Average	Some statistical data
The average age				51.69	Min:28 Max: 75 SS:10
Farming process				30.65	Min:5 Max: 60 SS:12.51
Cherry farming process				22.25	Min:3 Max: 50 SS:11.99
Educational Status	Illiterate:0	1	1.20		
	Literate:1	4	4.82		
	Primary school:2	33	39.76		
	Secondary school:3	15	18.07		
	High school:4	21	25.30		
	Associate degree:5	4	4.82		
	University: 6	5	6.02		



**V. INTERNATIONAL APPLIED STATISTICS CONGRESS (UYIK - 2024)**  
**İstanbul / Türkiye, May 21-23, 2024**

It is examined in Table 2 whether cherry producers in the rural areas of Tokat province make a living solely from cherry production. It was determined that more than half of the producers (58%) make a living solely from cherry production. Instead of specializing, 42% of cherry producers make a living by producing in other production lines or earning non-agricultural income without taking risks.

**Table 2.** Main source of income of cherry producers

	<b>Frequency</b>	<b>%</b>
Only cherry production	48	57.83
Additional work in cherry production	35	42.17

Cherry producers producing in the villages of Tokat center purchase an average of 17 tons of cherries from 23 decares of production area. It has been calculated that cherry producers earn an average income of 171,286 TL by selling 10 TL per kilo on average per year. It was determined that cherry producers had an average of 773 trees in an area of 23 decares. It has been determined that the average age of cherry trees is 15 years old, the minimum cherry tree is 3 years old and the maximum cherry tree is 40 years old. When examining how many years producers have owned cherry trees, it is seen in Table 3 that the longest is 57 years, the shortest is 5 years and the average is 21 years.

**Table 3.** Information on cherry production

	<b>Average</b>	<b>Some statistical data</b>
Cherry production amount (tons)	16.651	Min:1 Max:150 SS:22.112
Cherry production area (da)	23.18	Min:1.5 Max:125 SS:24.27
Average sales price (TL)	9.61	Min:3 Max:25 SS:5.36
Income from cherry production (TL)	171.286	Min:4.500 Max:162.000 SS:276.922
Number of trees (piece)	772.89	Min:10 Max:4000 SS:904.34
Average age of cherry trees (years)	14.82	Min:3 Max:40 SS:6.35
Ownership of a cherry orchard (years)	20.89	Min:5 Max:57 SS:10.66

To determine the problems experienced by cherry producers during cherry production, 27 different values were determined and these values were asked to the producers during the survey with a 5-point Likert scale. Cherry producers' production problems, that is, 27 values, were subjected to factor analysis in order to classify them, and as a result of the analysis, it was understood that 27 values could be grouped under 7 factors. As a result of the analysis, the KMO (Kaiser-Meyer-Olkin) test was 0.783, which indicates that the data set is in the perfect range for factor analysis (Kalaycı, 2010). In addition, it can be understood from the Bartlett test result that the model is significant, and the significance level (sig.) of 0.000 indicates that the model is significant at all significance levels. The reliability test result of the variables, that is, Cronbach's Alpha value, was found to be 0.834, which is an indication that the variables are within the reliable range. Thus, the suitability of both variables and the model was determined. It can be emphasized that the problems in cherry production are collected under 27 variables and 7 factor loads and the total load explains 71.61% of the model. In Table 4, variables and factor loadings for the problems faced by cherry producers in production are given.

**Table 4.** Problems encountered by cherry producers in production and their classification

Factor Names	Factors	Factor loadings	Explanation Variance of Factors
Input Costs	Irrigation costs too much	<b>0.818</b>	28.458
	Diesel costs a lot	<b>0.800</b>	
	I had a lot of expenses due to illness and disease.	<b>0.643</b>	
	Pruning costs are high	<b>0.629</b>	
Producer Consciousness	My technical knowledge is insufficient	0.793	36.770
	Follow the instructions for use while using medication	0.742	
	I do drip irrigation	0.741	
	I get agricultural insurance for cherries	-0.710	
	I use fertilizer	0.708	
	I have a soil analysis done.	0.692	
Labor Shortage	Insufficient labor force in harvest	<b>0.822</b>	44.725
	Labor costs are high	<b>0.787</b>	
	Workers are unconscious	<b>-0.764</b>	
Credit Usage	I had to use credit	0.898	52.375
	Loan interest rates are high	0.749	
Production Insufficiency	My cherries are not diverse	<b>0.685</b>	59.594
	Harvest losses are high	<b>0.667</b>	
Risks and Uncertainties	We feel climate change	0.732	65.617
	Unexpected rains	0.845	
	Drought	0.730	
	I experienced frost damage	0.635	
	I experienced hail damage	0.565	
Marketing	Producers cannot unite, there is no co-op.	<b>0.827</b>	71.611
	Markets are uncertain	<b>0.750</b>	
	Marketing is the most important problem	<b>0.670</b>	
	We cannot export	<b>-0.567</b>	
	We have no chance to determine the price	<b>0.511</b>	
KMO:0.783 sig: 0.000 cronbach's Alpha:0.834			

## DISCUSSION AND CONCLUSION

✓ The production problems experienced by the producers were tried to be determined as 27 variables. The problems of producers in production were grouped under 7 variables by factor analysis. The problems of producers in production are grouped under the headings: Input costs, producer awareness, labor shortage, credit use, production inadequacy, risk-uncertainties and marketing problems.

✓ It has been observed that producers are close to the upper limit of the active working age limit (average age of 51.69) and their education level is at primary school level. In other words, as a result of the research, it can be said that manufacturers who do not fight with innovations due to education and knowledge, although they are seen as experienced with age, have problems parallel to the problems that have not been solved for years.

✓ In Tokat province, which has an important place in agricultural production, it may be recommended to develop policies for generalization in the producer portfolio as well as support for producers.

✓ Additionally, supports for agricultural education can be applied in education.

### References

- FAO (Food and agriculture Organization). (2020). (<https://www.fao.org/faostat/en/#data/QCL>), Erişim tarihi 02 Mart 2022.
- Kalaycı, Ş. (2010). SPSS uygulamalı çok değişkenli istatistik teknikleri (5. Baskı), Asil Yayın Dağıtım, Ankara.
- Karpati, L., Z., Szakal. (2009). Marketing characteristics of tokaj wine specialities based on factor and cluster analyses. Applied Studies in Agribusiness and Commerce – APSTRACT Agroinform Publishing House, Budapest. p, 93-102.
- Kurtuluş, K. (2004). Pazarlama Araştırmaları (Genişletilmiş 7. Baskı). Literatür Yayınları, Yayın No, 114, s,397-418, İstanbul.
- Ness, M. (2000). Multivariate Techniques in Marketing Research. Curso de Especializacion Postuniversitaria en Marketing Agroalimentario, CHIEAM, Spain.
- Newbold, P. (1995). Statistics For Business and Economics, Prentice Hall International Editions.
- Tekin, V.N. (2007). SPSS Uygulamalı Bilimsel Pazarlama Araştırmaları. Seçkin Yayıncılık, Ankara.
- TÜİK (Türkiye İstatistik Kurumu). (2021). (<https://biruni.tuik.gov.tr/medas/?locale=tr>), Erişim tarihi 02 Mart 2022.

### Conflict of Interest

The authors have no conflict of interest.

### Author Contributions

Authors' contribution to the study is equal.





## Makine Öğrenmesi Yöntemleri ile İstenmeyen SMS Tespiti

**Vildan KARA<sup>1\*</sup>, Fatma NOYAN TEKELİ<sup>2</sup>**

<sup>1</sup>Yıldız Teknik Üniversitesi, Fen Edebiyat Fakültesi, İstatistik, 34220, İstanbul, Türkiye

\*Sorumlu yazar e-mail: vildan.kara@std.yildiz.edu.tr

### Özet

Günümüz bilgi çağıdır. Bilgi çağı, teknolojinin gelişmesiyle birlikte sorun çözme becerisini geliştirmeye başlamıştır. Otomotivden sağlığa, ekonomiden siber güvenliğe kadar birçok sektörde yer verilen makine öğrenmesi yöntemleri son yıllarda yaygın bir şekilde kullanılmaktadır.

Aynı zamanda makine öğrenmesi yöntemlerinin, istenmeyen mesajların tespitinde de önemli bir rolü vardır. İstenmeyen SMS, kısa mesaj kullanımının artış göndermesiyle birlikte kötü niyetli insanlar tarafından dolandırıcılık için bir seçenek olmuştur.

Yapılan çalışmada, UCI Makine Öğrenmesi deposun aracılığı ile elde edilen veriler üzerinde inceleme yapılmıştır. Gelen mesajların istenmeyen olup olmama durumu incelenmiş ve makine öğrenmesi yöntemleri ile analizler gerçekleştirilmiştir.

Çalışmanın amacı, kısa mesajlar içerisinde istenmeyen olanları mümkün olan en doğru şekilde tahmin etmektir. Bu amaç doğrultusunda, makine öğrenmesi yöntemlerinden Naive Bayes, Karar Ağacı ve Destek Vektör Makineleri'nden yararlanılmıştır. Model performans metriklerinin değerlendirilmesi ile çalışma sonunda en başarılı modelin destek vektör makineleri algoritması olduğu ortaya çıkmıştır.

**Anahtar Kelimeler:** Makine öğrenmesi, istenmeyen SMS, denetimli öğrenme, model performans metrikleri

### Abstract

Today is the information age. The information age has begun to improve problem-solving skills with the development of technology. Machine learning methods, which are used in many sectors from automotive to health, from the economy to cyber security, have been widely used in recent years.

At the same time, machine learning methods also play an important role in detecting unwanted messages. Unwanted SMS has become an option for fraud by malicious people with the increase in text messaging usage.

In the study, an analysis was made on the data obtained through the UCI Machine Learning repository. Whether the incoming messages were unwanted or not was examined, and analyses were carried out using machine learning methods.

The aim of the study is to predict unwanted messages among text messages as accurately as possible. For this purpose, machine learning methods such as Naive Bayes, Decision Tree, and Support Vector Machines were used. By evaluating the model performance metrics, it was revealed at the end of the study that the most successful model was the support vector machines algorithm.

**Keywords:** Machine learning, Spam, Supervised learning, Model performance metrics

### GİRİŞ

Mobil telefon teknolojisinin hızla gelişmesiyle birlikte, SMS – kısa mesaj servisi (Short Message Service ) kullanımı günümüzde önemli bir yer edinmiştir. SMS erişilebilirlik ve pratiklik bakımından güncel bir iletişim kanalıdır. Kurumlar, markalar ve bireyler arasında hızlı bilgi alışverişi, duyuru yapma gibi amaçlar için sıklıkla tercih edilmektedir.

SMS kullanımını hızlı iletişim ile hayatı kolaylaştırmasının yanı sıra art niyetli insanların amaç dışı kullanımında maddi veya manevi zararlarla karşılaşmak mümkün olmaktadır. Bilinmeyen adreslerden güvenlik tehdidi oluşturma hedefiyle gönderilen ve şüpheli içeriğe sahip SMS'ler «istenmeyen SMS» (spam) olarak adlandırılmaktadır. İstenmeyen SMS türleri, göndericinin niyetine göre çeşitlilik göstermektedir. Bu tür mesajlar arasında bahis mesajları, dolandırıcılık içerikli mesajlar ve reklam amaçlı mesajlar gibi farklı örnekler gösterilebilir. (Karasoy ve Ballı, 2016)

Yapılan çalışmada, istenmeyen SMS'leri tespit etmek için birkaç denetimli makine öğrenmesi algoritması kullanılmıştır. Bu amaçla, tercih edilen denetimli öğrenme algoritmaları arasından yaygın olarak kullanılanlar tercih edilmiştir. İlgili algoritmaların kullanılması, istenmeyen SMS'leri tespit etmek ve bunları filtrelemek için güvenilir bir yaklaşım olarak kabul edilmektedir.

## GEREÇ VE YÖNTEMLER

### Makine Öğrenmesi

Çok eski zamanlardan beri, insanlar işlerini kolaylaştırmak ve göstermiş oldukları çabayı azaltmak için makineler üretmiştir. Bilgisayarlar ya da makineler yapmış oldukları bütün işlemleri daha önceden tanımlanmış algoritmalar üzerinden gerçekleştirirler. Makine öğrenmesinin temel amacı, önceki verileri kullanarak karmaşık örüntüleri algılayabilen ve yeni problemlere çözüm bulabilen modeller oluşturmaktır. (Çelik,2018)

Makine öğrenmesi yöntemleri gelen veri türüne uygun algoritmaları seçmek için geliştirilmiştir. Algoritmalar türlerine göre sınıflama, regresyon, kümeleme yapabilme özelliklerine sahiptirler. Bu yöntemler;

- Denetimli öğrenme (Supervised learning)
- Denetimsiz öğrenme (Unsupervised learning)
- Yarı denetimli öğrenme (Semi-supervised learning)
- Takviyeli öğrenme (Reinforcement learning)

şeklinde dört kategoriye ayrılabilir.

Makine öğrenimi yöntemlerinden biri olan denetimli öğrenme, modellerin tahminleme yaparken etiketli eğitim verilerini kullanan bir öğrenme türüdür. Denetimli öğrenmede girdi ( $x_i$ ) ve çıktı ( $y_i$ ) veri kümeleri birlikte verilmiştir. Burada sonuçları bilinen veri kümeleri incelenerek ortaya çıkan modelden hareketle sonuçları bilinmeyen veri kümesi hakkında tahminler yapılır. Sonuçları bilinen veri kümesi eğitim verisidir ve makinenin model oluşturmasını sağlar. Oluşan model kullanılarak yapılan tahminlerde test verileri işlenir. (Singh, 2016; Thakur vd., 2016)

### Model Performans Değerlendirmesi

**Tablo 12.** Karmaşıklık matrisi

		Tahmin Edilen		Toplam
		Pozitif	Negatif	
Gerçek	Pozitif	Doğru Pozitif (TP)	Yanlış Negatif (FN)	Gerçek Pozitif Sayısı
	Negatif	Yanlış pozitif (FP)	Doğru Negatif (TN)	Gerçek Negatif Sayısı
Toplam		Tahmin Pozitif Sayısı	Tahmin Negatif Sayısı	Toplam Örnek Sayısı (N)

Karmaşıklık matrisi diğer bir adıyla hata matrisi, makine öğrenmesinde sınıflandırma algoritmalarının tahmin sonuçlarının doğruluğunu ölçmek için geliştirilen bir yöntemdir.

Doğruluk (Accuracy): Doğru şekilde sınıflandırılmış örnek sayısının tüm örnek sayısına oranına doğruluk denir. (Baktır ve Atay, 2022)

$$\text{Doğruluk} = \frac{TP + TN}{N}$$

Kesinlik (Precision): Pozitif olarak tahmin edilen değerlerin doğru tahmin edilebilme oranının ölçülmesidir.

$$\text{Kesinlik} = \frac{TP}{TP + FP}$$

Duyarlılık (Recall, TPR) : Pozitif sınıfta olduğu bilinen verilerin test sonucunda da doğru tahmin edilerek pozitif sınıfa etiketlenme olasılığıdır.

$$\text{TPR} = \frac{TP}{TP + FN}$$

Doğru Negatif Oranı (TNR): Negatif sınıfa ait olduğu bilinen verilerin test sonucunda da doğru tahmin edilerek negatif sınıfa etiketlenme olasılığıdır.

$$\text{TNR} = \frac{TN}{TN + FP}$$

F1 Skoru : Kesinlik ve duyarlılık arasındaki dengenin bulunması amacıyla F1 skoru kullanılmaktadır. F1 skoru kesinlik ve duyarlılık metriklerinin harmonik ortalamasıdır. Sınıf dengesizliği durumunda daha dayanıklı sonuç verir. (Uslu ve Özmen-Akyol, 2021)

$$\text{F1 skoru} = 2 * \frac{\text{kesinlik} * \text{duyarlılık}}{\text{kesinlik} + \text{duyarlılık}}$$

ROC Eğrisi: ROC (Receiver Operating Characteristic) eğrisi dikey ekseninde doğru pozitif oranı, yatay ekseninde ise yanlış pozitif oranının yer aldığı bir eğridir. ROC eğrisinde eğrinin altında kalan alan AUC (Area Under Curve) olarak adlandırılır ve 0 ile 1 arasında değer alır. Eğrinin altında kalan alan büyüdükçe modelin başarı oranı artmaktadır. Eğri ortaya yaklaştığı durumlarda da modelin başarı oranı azalmaktadır. Sınıf dengesizliğine karşı dayanıklıdır.

### Veri Ön İşleme

Veri ön işleme, veri kümesinin kullanıma uygun hale gelmesi için düzenlenen bir dizi işlemdir. Bir veri setinin analizine hazırlık aşamasıdır. Veri ön işleme veri setinin makine öğrenmesi yöntemlerini de kullanmaya hazır hale getirir. Ön işlemede veri kalitesi artırılarak ham verinin analiz yapılabilir hale gelmesi sağlanır. Veri setindeki gürültü azaltılarak, eksik verileri çıkarmak ya da düzenlemek gibi adımlar içerebilir. Bu gibi işlemler sonucunda, verinin kalitesi artar ve analiz sonuçları da güvenilir olması amaçlanır. (Çelik ve Koç, 2021)

Veri Normalizasyonu: Verideki büyük harf – küçük harf uyumsuzluğunu ortadan kaldırmak için uygulanan bir ön işleme adımdır. Büyük harfler küçük harfe dönüştürülerek farklılıkların göz ardı edilmesi sağlanır.

Veri Tokenizasyonu: Metin mesajlarını daha küçük parçalar olan tokenlere bölme işlemidir. Burada token kelime ya da noktalama işareti olan karakterlerdir.



Etkisiz Elemanları Kaldırma: Dil yapısı gereği sıkça kullanılan ancak genellikle anlamı olmayan ya da cümlenin anlamında herhangi bir değişiklik yapmayan etkisiz elemanları cümlelerden kaldırarak uygulanan bir ön işleme adıdır.

Veri Vektörizasyonu: Metin verilerini makine öğrenmesi algoritmalarıyla kullanılabilir hale getirmek için kelimeleri sayılara dönüştürme işlemidir. (Kabra ve Nagar, 2023)

Temel olarak, TF-IDF metin belgelerinin sayısal vektörlerle temsil eder. Burada TF, belirli bir kelimenin mesajda ne sıklıkla geçtiğini ifade eder. IDF, belirli kelimenin tüm metinde ne kadar yaygın olduğuna bakar. TF-IDF değeri ise terim frekansının, ters doküman frekansıyla çarpımıdır.

$$TF(t, d) = \frac{\text{kelimenin belgedeki toplam görülme sayısı}}{\text{belgedeki toplam kelime sayısı}}$$

$$IDF(t) = \log \left( \frac{\text{toplam belge sayısı}}{\text{terim olan kelimenin bulunduğu belge sayısı}} \right)$$

$$TF - IDF = TF(t, d) \times IDF(t)$$

Veriyi Bölme: Veri kümesi eğitim kümesi ve test kümesi olmak üzere ikiye ayrılmaktadır. Eğitim kümesi modelin öğrenmesi için kullanılırken, test kümesi ise modelin performansının değerlendirilmesi için kullanılır.

SMOTE: Sentetik Azınlık Aşırı Örnekleme Tekniği (SMOTE), dengesiz veri kümeleri üzerinde çalışırken sıkça kullanılan bir örnekleme yöntemidir. Bu teknik, azınlık sınıfındaki örnekleri çoğaltarak veri kümesini dengelemeyi amaçlar. SMOTE, azınlık sınıftaki örneklerin en yakın k komşusunu baz alarak sentetik örnekler üreterek, veri setindeki dengesizliği giderir. (Abid, 2022; Ullah vd., 2022)

### Sınıflandırma Algoritmaları

Naive Bayes

Bayes teoreminden yararlanılarak oluşturulmuş olan bu algoritma kolay anlaşılabilir ve uygulanabilir olduğu için sıklıkla tercih edilir. Eldeki sınıflandırılmış verilerden yeni gelecek verinin sınıf etiketini bulmaya yarayan bir yöntemdir. Koşullu olasılıkları temel alan Bayes algoritması bir veri için tüm olasılıkları hesaplar ve olasılık değeri en yüksek olana göre sınıflandırma yapar.

Karar Ağaçları (Decision Trees)

Karar ağaçları kökten başlayıp veriyi belli özelliklere göre bölerek ilerleyen bir ağaç yapısıdır. Her ağaç kök, düğüm ve yapraklardan oluşur. Burada model karar kurallarını öğrenmesiyle hedef değişkeni tahmin etmeye çalışır. Başka bir deyişle veri kümesini küçük kümelere ayırarak gruplama için kolaylık sağlar.

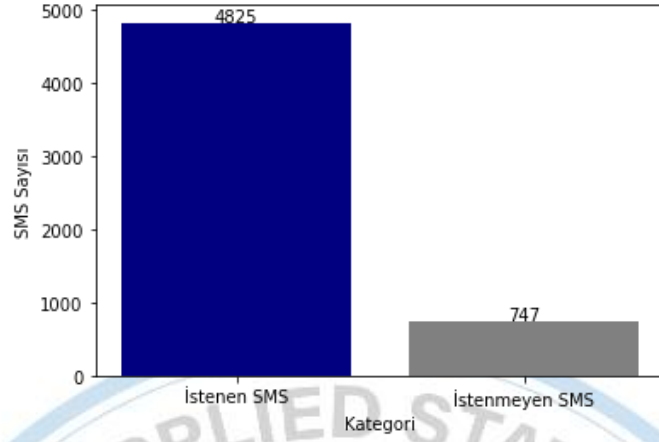
Destek Vektör Makineleri (Support Vector Machines)

Destek vektör makinelerinde her veri noktası  $n$ -boyutlu bir uzayda temsil edilir. Ardından noktalar arasında oluşan mesafeler için iki sınıfı birbirinden ayıran bir hiper düzlem oluşturularak sınıflandırma gerçekleştirilir. Algoritmanın amacı iki sınıfı birbirinden en iyi şekilde ayırabilen başka bir deyişle ayrılan sınıflar arasındaki uzaklığı maksimum yapan hiper düzlemi bulabilmektir. (Yu ve Xu, 2008)

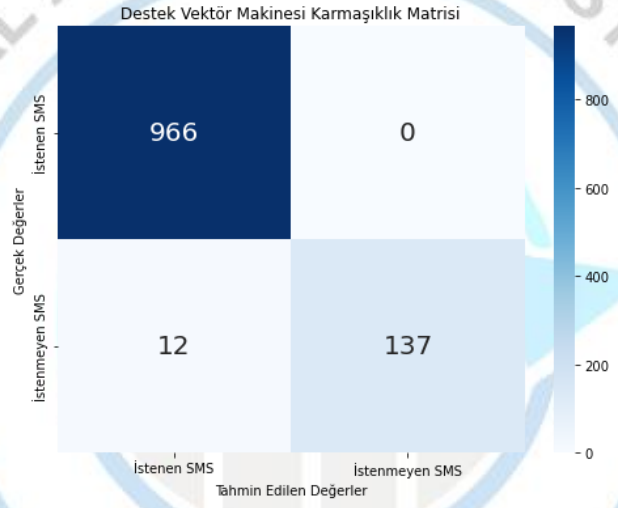
### UYGULAMA

Çalışmada, 2012 yılında hazırlanmış, toplamda 5572 adet, başlarında orijinal/ istenen SMS veya istenmeyen SMS(Ham or Spam) olarak etiketlenmiş İngilizce dilindeki kısa mesajlardan oluşmaktadır. Veri kümesindeki bağımlı değişken mesaj etiketleri, bağımsız değişken ise İngilizce dilindeki SMS'lerdir.

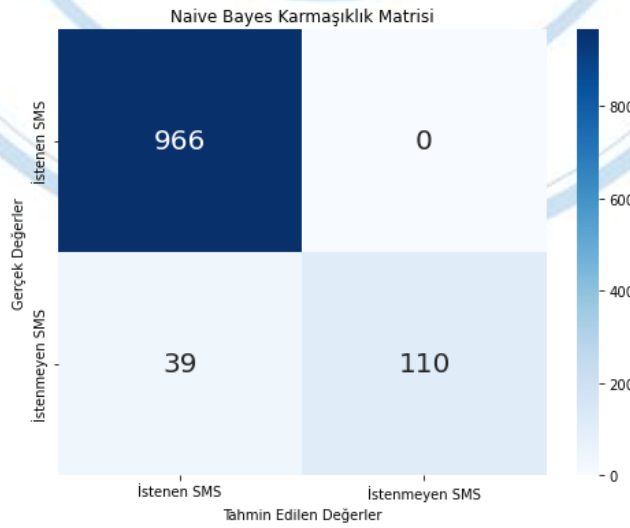
Veri kümesi UCI Makine Öğrenmesi deposundan elde edilmiştir. (Almeida ve Hidalgo, 2012) Veri kümesinde 4825 adet istenen SMS bulunurken istenmeyen sınıfta ise 747 adet mesaj vardır.



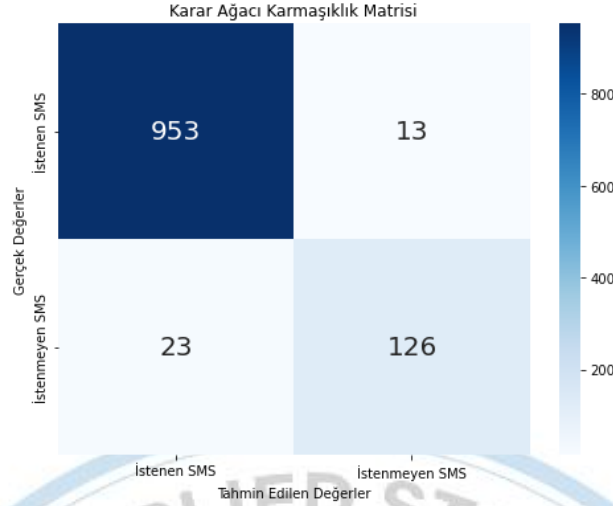
Şekil 1. İstenen ve İstenmeyen SMS Sayısı



Şekil 2. Destek Vektör Makinesi Karmaşıklık Matrisi



Şekil 3. Naive Bayes Karmaşıklık Matrisi



Şekil 4. Karar Ağacı Karmaşıklık Matrisi

Model performanslarını değerlendirmek için oluşturulan karmaşıklık matrislerine bakıldığında modelin istenmeyen sınıfı doğru bir şekilde tanımakta zorlandığı görülmektedir.

Tablo 13. Model algoritmalarının doğruluk değerleri

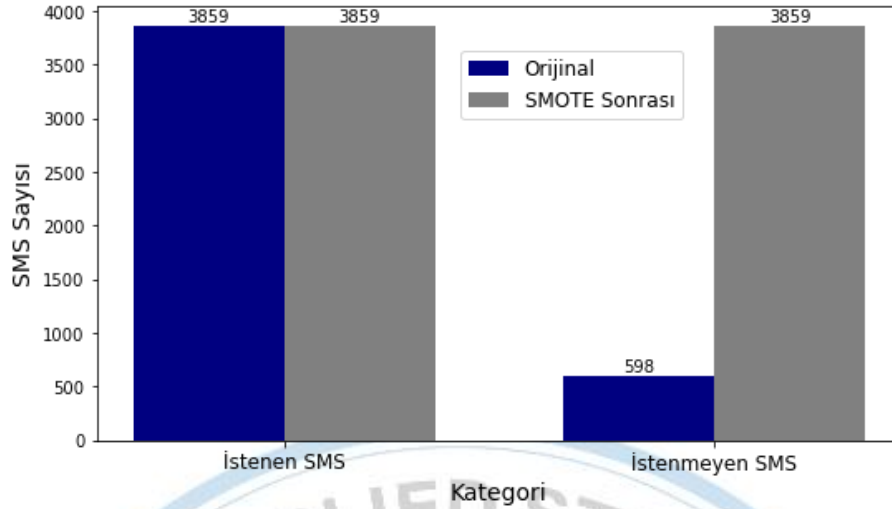
Model Algoritmaları	Accuracy (Doğruluk)
Naïve Bayes	0.9650
Karar Ağaçları	0.9686
Destek Vektör Makineleri	0.9892

Karar verilirken yalnızca doğruluk değerlerine bakmak, dengesiz veri kümeleriyle ilgili doğru bir değerlendirme yapmayı zorlaştırır. Bu durumun temel nedeni, doğruluk değerinin yanıltıcı olabilme ihtimalidir.

Veri kümesinde istenmeyen sınıfın örnek sayısı az olduğu için tüm örnekler istenen SMS sınıfında tahmin edilse bile doğruluk değeri çok düşük olmayabilir. Dolayısıyla yalnızca doğruluk değerlerine bakarak yorum yapmak yeterli değildir. Dengesiz veri setleri üzerinde model performansını değerlendirirken farklı metriklerin incelenmesi de önemlidir.

Veri kümesindeki eğitilmiş modellerin performans değerlendirilmesi yapıldı. Ancak veri kümesindeki dengesizlik nedeniyle, azınlık sınıfının düşük örnek sayısı, model performansını olumsuz yönde etkileyebilir. Bu nedenle ek olarak SMOTE (Synthetic Minority Over-Sampling Technique-Sentetik Azınlık Aşırı Örnekleme Tekniği) uygulaması yapılmıştır. SMOTE uygulaması, azınlık sınıfındaki örneklerin sayısını artırarak, modelin azınlık sınıfını daha iyi öğrenmesini sağlamıştır.





Şekil 5. İstenen ve İstenmeyen SMS Sayıları: Orijinal ve SMOTE Sonrası

Eğitim veri kümesindeki istenen SMS sayısı 3859 iken istenmeyen SMS sayısı ise 598 adettir. SMOTE uygulamasının ardından istenen ve istenmeyen SMS sayıları eşitlenmiştir.

Tablo 14. Model Algoritmalarının SMOTE Öncesi ve Sonrası Performans Metrikleri

Model Algoritmaları	Performans Metrikleri			
	TNR	TPR	F1 Skoru	AUC
Naïve Bayes	1.0	0.7382	0.8494	0.8691
Karar Ağaçları	0.9865	0.8456	0.8750	0.9161
Destek Vektör Makineleri	1.0	0.9194	0.9580	0.9597
SMOTE + Naive Bayes	1.0	0.7577	0.8621	0.8789
SMOTE + Karar Ağaçları	0.9865	0.8819	0.9306	0.9343
SMOTE + Destek Vektör Makineleri	1.0	0.9616	0.9804	0.9808

## SONUÇ

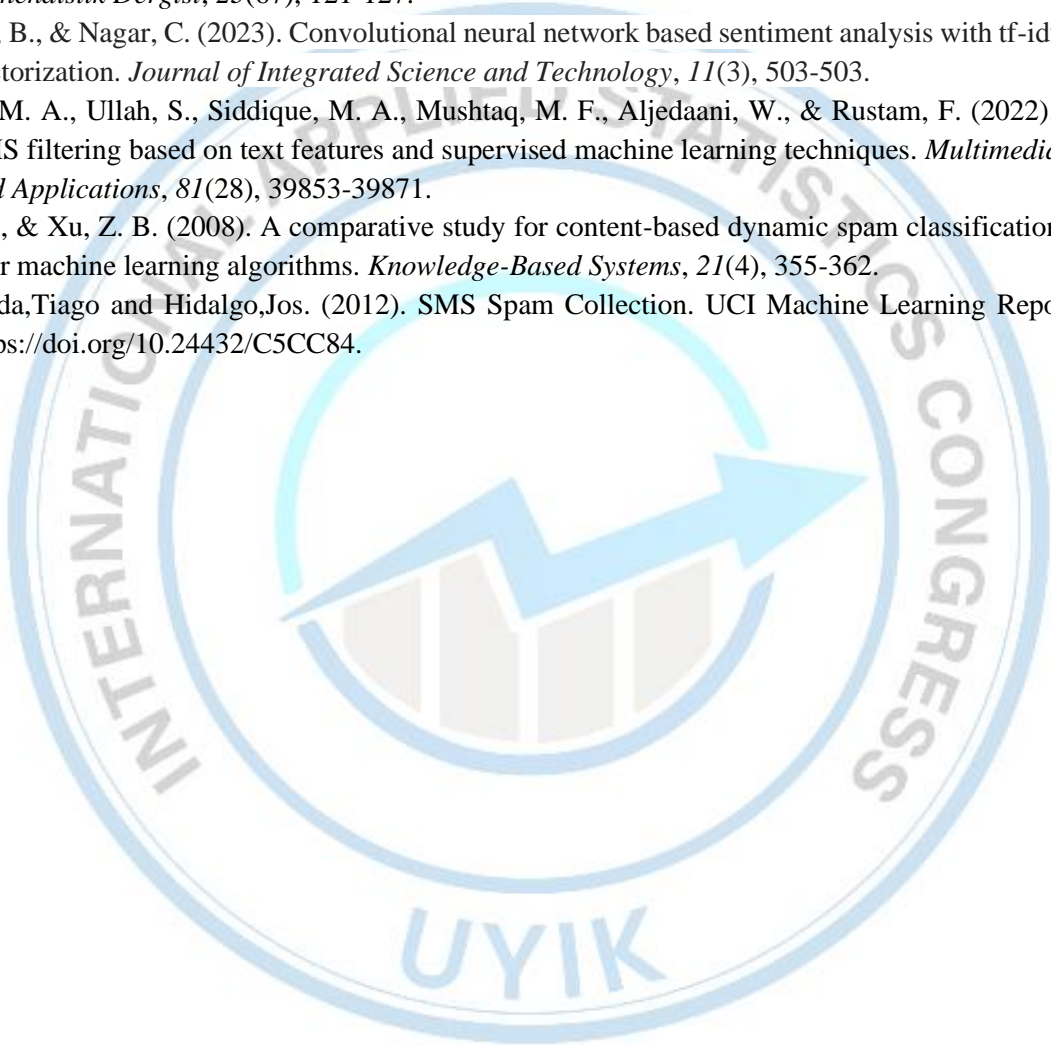
Bu çalışma, istenmeyen SMS'lerin tespitine odaklanmaktadır. Veri kümesi çeşitli ön işlemlerden geçerek makine öğrenmesi algoritmalarının kullanımına uygun hale gelmiştir. Burada, istenmeyen SMS tespiti için üç farklı denetimli makine öğrenmesi algoritması tercih edilmiştir: Naive Bayes, Karar Ağaçları ve Destek Vektör Makineleri. Veri kümesi her bir algoritma için test edilmiş ve kullanılan algoritmaların başarımları çeşitli metriklerle değerlendirilmiştir. Sonrasında veri kümesine SMOTE uygulanarak tekrar model performans metrikleri incelenmiştir. Burada SMOTE öncesi ve sonrası şeklinde iki farklı değerlendirme yapılmasının sebebi sınıf dengesizliği durumunda model performans metriklerini incelenmesinin ardından sınıf dengesizliği durumu ortadan kalktıktan sonra performans metriklerinin daha kaliteli sonuçlar verdiğini göstermektedir.

Elde edilen sonuçlarda en başarılı sınıflandırma algoritması olarak destek vektör makineleri karşımıza çıkmaktadır. Bu sonuçlar sayesinde istenmeyen SMS'lerin etkili bir şekilde tespit edilmesi için bu algoritmanın kullanımının uygun olduğu ortaya çıkmaktadır.

## KAYNAKÇA

- Karasoy, O., & Ballı, S. (2016). İçerik Tabanlı İstenmeyen SMS Filtreleme için Mobil Uygulama Geliştirilmesi ve Sınıflandırma Algoritmalarının Karşılaştırılması. In *International Artificial Intelligence and Data Processing Symposium (IDAP'16)*.
- Çelik, Ö. (2018). A research on machine learning methods and its applications. *Journal of Educational Technology and Online Learning*, 1(3), 25-40.

- Singh, A., Thakur, N., & Sharma, A. (2016, March). A review of supervised machine learning algorithms. In 2016 3rd international conference on computing for sustainable global development (INDIACom) (pp. 1310-1315). Ieee.
- Baktır, N., & Atay, Y. (2022). Makine Öğrenmesi Yaklaşımlarının Spam-Mail Sınıflandırma Probleminde Karşılaştırmalı Analizi. *Bilişim Teknolojileri Dergisi*, 15(3), 349-364.
- Uslu, O., & Özmen-akyol, S. (2021). Türkçe haber metinlerinin makine öğrenmesi yöntemleri kullanılarak sınıflandırılması. *Eskişehir Türk Dünyası Uygulama ve Araştırma Merkezi Bilişim Dergisi*, 2(1), 15-20.
- Çelik, Ö., & Koç, B. C. (2021). TF-IDF, Word2vec ve Fasttext vektör model yöntemleri ile Türkçe haber metinlerinin sınıflandırılması. *Dokuz Eylül Üniversitesi Mühendislik Fakültesi Fen ve Mühendislik Dergisi*, 23(67), 121-127.
- Kabra, B., & Nagar, C. (2023). Convolutional neural network based sentiment analysis with tf-idf based vectorization. *Journal of Integrated Science and Technology*, 11(3), 503-503.
- Abid, M. A., Ullah, S., Siddique, M. A., Mushtaq, M. F., Aljedaani, W., & Rustam, F. (2022). Spam SMS filtering based on text features and supervised machine learning techniques. *Multimedia Tools and Applications*, 81(28), 39853-39871.
- Yu, B., & Xu, Z. B. (2008). A comparative study for content-based dynamic spam classification using four machine learning algorithms. *Knowledge-Based Systems*, 21(4), 355-362.
- Almeida, Tiago and Hidalgo, Jos. (2012). SMS Spam Collection. UCI Machine Learning Repository. <https://doi.org/10.24432/C5CC84>.



## Variant Analysis in Human Genome Sequences Using Surrogate Modelling and Machine Learning

**Furkan Aydın<sup>1\*</sup>, Süha Tuna<sup>2</sup>**

<sup>1</sup>Istanbul Technical University, Informatics Institute, Department of Computer Science, 34722, İstanbul, Türkiye

<sup>2</sup>Istanbul Technical University, Informatics Institute, Department of Computational Science and Engineering, 34722, İstanbul, Türkiye

\*Corresponding author e-mail: aydinf16@itu.edu.tr

### *Abstract*

*In contemporary research, accurate estimation of complex diseases necessitates a comprehensive analysis that involves the combination of multiple gene sequences. Moreover, within the realm of artificial intelligence, several methodologies have emerged to construct trainable models by leveraging multiple one-dimensional gene sequences in tandem. This study investigates a two-step pre-processing methodology. Initially, an extensive high-dimensional model is devised to encapsulate the entire gene sequence information. Subsequently, dimensionality reduction techniques are applied to facilitate the effective application of machine learning models. The efficacy of this approach is evaluated using two gene networks associated with complex diseases: mTOR and TGF- $\beta$ . To construct the high-dimensional model, Chaos Game Representation and Enhanced Multivariate Products Representation techniques are employed respectively. Following this, Principal Component Analysis is utilized for dimensionality reduction. After the preprocessing stage, the corresponding dataset is partitioned into training and testing sets to rigorously assess the accuracy of the machine learning model. A Support Vector Machine algorithm is selected as the primary machine learning approach. Subsequently, a 5-fold cross-validation procedure is conducted to validate the robustness and generalization capabilities of the model. The computational experiments produced encouraging results, with the method demonstrating prediction accuracies exceeding 90% and 99% for the TGF- $\beta$  and mTOR networks, respectively. Despite the limited number of training samples, these results are promising, particularly within the mTOR network. In conclusion, the proposed method provides excellent and consistent classification accuracy for the networks under consideration. Consequently, the proposed method yields promising results in distinguishing between patient and healthy groups based on the genotype.*

**Keywords:** Variant Analysis, Genomic Sequences, Enhanced multivariate Products Representation, Machine learning, Gen network Analysis

### **INTRODUCTION**

In recent years, the application of machine learning techniques in bioinformatics has gained significant attention and popularity. Genome-wide association studies (GWAS) (Dehghan, 2018) play a crucial role in identifying genomic variants associated with complex diseases and conditions. These studies enable the determination of the most significant variants linked to a particular trait or disease, and bioinformatics methods can be employed to elucidate the underlying gene networks. (Barabási et al., 2010) (Choobdar et al., 2019) (Hawe et al., 2019).

The prediction of an individual's susceptibility to a specific illness or condition based on their genetic profile is a key application of GWAS results, typically achieved using a Polygenic Risk Score (PRS) (Choi et al., 2020). However, the clinical application of PRS is limited by several factors, including the ethnic bias of GWAS studies and the polygenic nature of many phenotypic traits. To address these

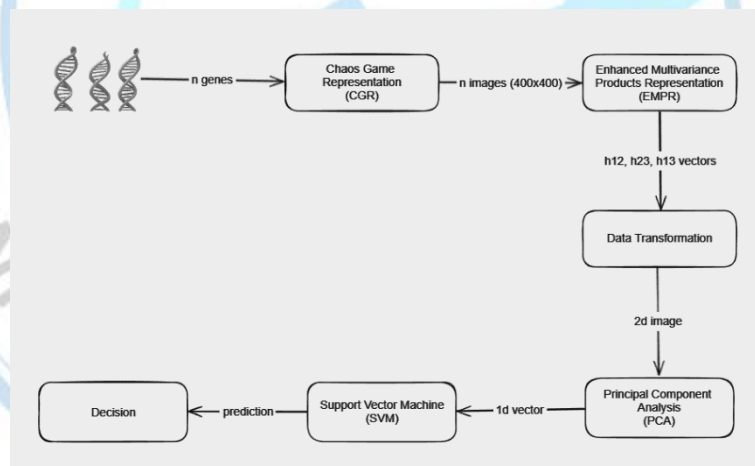


challenges, novel strategies are required to improve the accuracy of PRS and develop more effective tools for predicting an individual's risk of disease. This paper proposes a method that utilizes high-dimensional modeling to generate a learning data model from gene sequences. The generated data model is then used to train a machine learning algorithm. The proposed approach involves feature extraction, dimension reduction, and machine learning steps, consecutively.

In the feature extraction step, two methods are employed. Firstly, the Chaos Game Representation (CGR) (Jeffrey, 1990) (Almeida et al., 2001) is applied to all genes in the network, creating a two-dimensional picture from each one-dimensional gene sequence data. The obtained images are then arranged to form a three-dimensional model. Each image created using this model is unique, resulting in a unique three-dimensional cube that represents the gene sequence. Secondly, the Enhanced Multivariate Products Representation (EMPR) (Tunga and Demiralp, 2010) method is used, which provides a representation method for three-dimensional data.

After the feature extraction phase, the machine learning method needs more compact and tangible data. To overcome this issue, a dimension reduction step is executed. Two methods are employed in this step. Firstly, data transformation is used to create an inclusive and relational model (Fink, 2009). The three two-dimensional data acquired by the EMPR are selected and concatenated in a specific order to create a two-dimensional relational structure. Subsequently, Principal Component Analysis (PCA) (Abdi and Williams, 2010) is applied to reduce the dimension to a vector.

After completing all pre-processing steps, all gene sequences are converted to a vector. The machine learning method can then be applied to perform classification. In the final step, Support Vector Machine (SVM) (Hearst et al., 1998) is selected as the machine learning method to classify the gene network as healthy or not. The SVM is a popular approach for high dimensional classification tasks, offering a balance between accuracy and repeatability (Pisner and Schnyer, 2020).



**Figure 1.** Flow chart of the proposed technique

The overall flow chart is demonstrated in Figure 1. Finally, the overall model was trained and tested using mTOR (Wullschleger et al., 2006) and TGF- $\beta$  (Tzavlaki and Moustakas, 2020) with 5-fold cross-validation (Browne, 2000) The mTOR and TGF- $\beta$  gene networks comprise 31 and 93 genes, respectively. The highest accuracy achieved by the gene networks is over 99% and 90%, respectively.

## MATERIAL AND METHODS

### Material

The KEGG database is utilized as the primary source for both the training and testing datasets in this study. The implementation of statistical analyses and method algorithms is facilitated through the use of MATLAB and Python programming languages.

## Methods

### *The Collection of the Data*

The mTOR and TGF- $\beta$  pathways were selected from the KEGG database, and their corresponding genomic sequences were retrieved from the GRCh37 human genome database. The mTOR pathway comprises 31 genes, while the TGF- $\beta$  pathway consists of 93 genes. Subsequently, control and patient sequences were generated by introducing random variations in the gene sequences, resulting in a total of 800 sequences for each gene network. The introduced variations were categorized into two distinct lists: polymorphic positions (common variants) and pathogenic positions (disease-associated variants). At each position, the reference base was replaced with a variant base, with differing frequencies for control and patient sequences (Tuna et al., 2023). This approach was designed to mimic complex disorders, where multiple variants with higher allele frequencies contribute to the disease. To avoid bias, novel datasets were created.

### *Chaos Game Representation*

The Chaos Game Representation (CGR) algorithm is a method for generating unique visual representations of a gene sequence using an iterative process. The algorithm consists of the following steps:

1. Select the size of the plane.
2. Choose an initial point in the plane, typically the center of the image.
3. Determine what data the corners (vertices) in the plane represent.
4. Select one of the vertices that corresponds to the input and move the last point halfway towards that vertex. This step can be mathematically defined as:

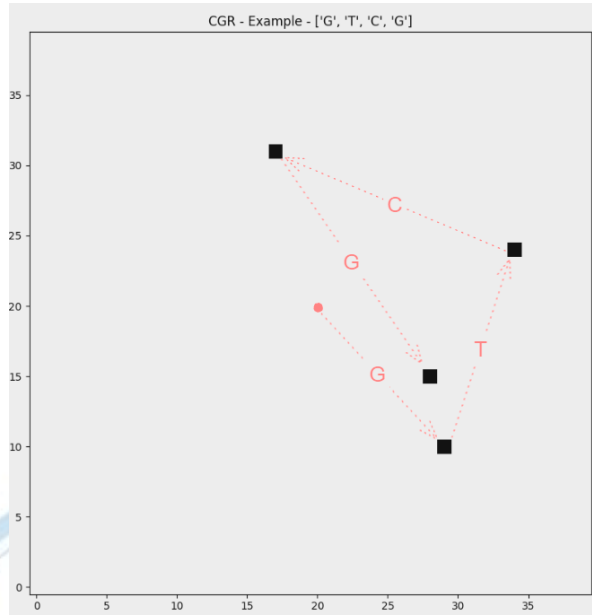
$$X_i = \frac{1}{2}(X_{i-1} + C_i^{(x)})$$

$$Y_i = \frac{1}{2}(Y_{i-1} + C_i^{(y)})$$

where  $X_0$  and  $Y_0$  are the initial points,  $C_i^{(x)}$  and  $C_i^{(y)}$  are the vertex coordinates, and  $i$  is the iteration number.

5. Repeat step 4, with each iteration reading an input and moving the last point halfway towards that vertex.

As the number of iterations increases, the pattern generated by the CGR algorithm becomes increasingly complex and self-similar, exhibiting characteristic features of the input. The CGR algorithm is particularly useful for generating 2-dimensional representations of DNA sequences, where the vertices are typically associated with the four nucleotide bases Adenin (A), Thymine (T), Cytosine (C) and Guanine (G), respectively. By applying the CGR algorithm to DNA sequences, it is possible to identify patterns and features that are not easily visible using other methods, making it a powerful tool for exploring the structure and function of DNA.



**Figure 2.** CGR image generation scheme

Figure 2 demonstrates the creation of a 40x40 CGR table with 4 nucleotide inputs, where indices are defined as Adenine (0, 0), Guanine (40, 0), Cytosine (0, 40), and Thymine (40, 40).

The resolution of the CGR image, which is the size of the CGR plane, is crucial and can impact the quality of the gene sequence representation. If the CGR image size is too small, points may overlap, preventing them from contributing to the overall pattern. Conversely, if the image size is too large, gaps may appear between points, detrimental to the CGR pattern's ability to represent the data. Therefore, determining the optimal resolution for a CGR image is essential for enhancing the quality of the representation.

#### Enhanced Multivariate Products Representation

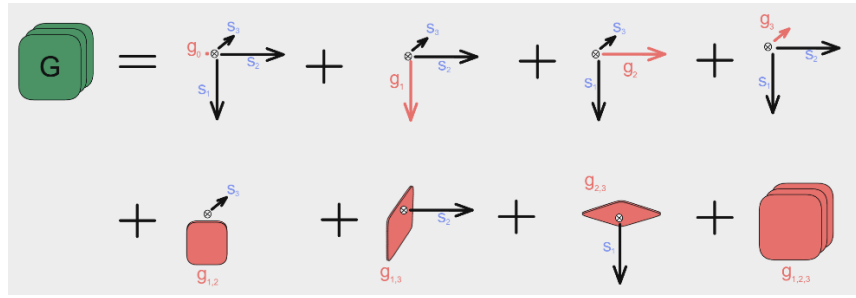
Enhanced Multivariate Products Representation (EMPR) is a powerful method for decomposing complex, high-dimensional data into simpler, lower-dimensional components (Tuna et al., 2021). By reducing the number of dimensions, EMPR enables more efficient analysis and processing of multidimensional data. This work focuses on the 3D case, but the formulations can be applied to N-dimensional data, easily.

Assuming  $G$  is a 3-dimensional cube of size  $n_1 * n_2 * n_3$ , the explicit EMPR expansion of the cube can be presented as follows:

$$G = g^{(0)} \left[ \bigotimes_{r=1}^3 s^{(r)} \right] + \sum_{i=1}^3 g^{(i)} \otimes \left[ \bigotimes_{\substack{r=1 \\ r \neq i}}^3 s^{(r)} \right] + \sum_{\substack{i,j=1 \\ i < j}}^3 g^{(i,j)} \otimes \left[ \bigotimes_{\substack{r=1 \\ r \neq i,j}}^3 s^{(r)} \right] + g^{(1,2,3)}$$

where  $g^{(0)}$ ,  $g^{(i)}$  and  $g^{(i,j)}$  are EMPR components called the zero-way, the one-way, and the two-way, respectively.  $\otimes$  denotes the outer product operation (Kolda and Bader, 2009).  $s^{(r)}$  is the  $r$ -th support vector, which is a  $n_r$  dimensional vector.





**Figure 3.** EMPR decomposition for 3D data case

Figure 3 provides a graphical representation of the EMPR decomposition. The zero-way, one-way, and two-way EMPR components have dimensions of zero, one, and two, respectively, and considered as a scalar, a vector, and a matrix. Support vectors are multiplied with the respective EMPR components by following the outer product definition to increase dimensionality. Additionally, they offer flexibility for EMPR expansion and should be chosen carefully. This decision is important since it influences the EMPR expansion's eligibility for representation.

There are various methods to calculate a support vector, but the equation below represents an averaged direction for the  $G$  cube, known as Averaged Directional Support (ADS) (Tuna et al., 2021). In this paper, the Averaged Directional Supports are employed to calculate support vectors using EMPR. The support vectors using ADS can be calculated as follows:

$$S_i^{(1)} = \sum_{j=1}^{n_2} \sum_{k=1}^{n_3} w_j^{(2)} w_k^{(3)} G_{ijk},$$

$$S_i^{(2)} = \sum_{i=1}^{n_1} \sum_{k=1}^{n_3} w_i^{(1)} w_k^{(3)} G_{ijk},$$

$$S_i^{(3)} = \sum_{i=1}^{n_1} \sum_{j=1}^{n_2} w_i^{(1)} w_j^{(2)} G_{ijk}$$

where  $w^{(1)}$ ,  $w^{(2)}$  and  $w^{(3)}$  are the weight vectors. The selection of the appropriate weight vectors to represent the  $G$  cube under evaluation is critical, as weighted averages are a fundamental component of EMPR. A key requirement is that the total elements of each weight vector should sum up to 1, which is a statistical necessity (Tuna et al., 2021). This attribute is maintained to facilitate the computations involved in calculating the EMPR components. In the simplest scenario, the weights are uniformly distributed, as shown in the following equation:

$$w_i^{(1)} = \frac{1}{n_1}, \quad w_j^{(2)} = \frac{1}{n_2}, \quad w_k^{(3)} = \frac{1}{n_3}$$

If EMPR components are calculated one by one by calculating all these situations together, the following equations are obtained. The zero-way EMPR component can be calculated as follows:

$$g^{(0)} = \sum_{i=1}^{n_1} \sum_{j=1}^{n_2} \sum_{k=1}^{n_3} w_i^{(1)} w_j^{(2)} w_k^{(3)} s_i^{(1)} s_j^{(2)} s_k^{(3)} G_{ijk}$$

Moreover, three one-way EMPR components can be calculated as follows:

$$g_i^{(1)} = \sum_{j=1}^{n_2} \sum_{k=1}^{n_3} w_j^{(2)} w_k^{(3)} s_j^{(2)} s_k^{(3)} G_{ijk} - g^{(0)} s_i^1,$$

$$g_j^{(2)} = \sum_{i=1}^{n_1} \sum_{k=1}^{n_3} w_i^{(1)} w_k^{(3)} s_i^{(1)} s_k^{(3)} G_{ijk} - g^{(0)} s_j^2,$$

$$g_k^{(3)} = \sum_{i=1}^{n_1} \sum_{j=1}^{n_2} w_i^{(1)} w_j^{(2)} s_i^{(1)} s_j^{(2)} G_{ijk} - g^{(0)} s_k^3$$

Similarly, three two-way EMPR components can be obtained explicitly as follows:

$$g_{ij}^{(1,2)} = \sum_{k=1}^{n_3} w_k^{(3)} s_k^{(3)} G_{ijk} - g^{(0)} s_i^{(1)} s_j^{(2)} - g_i^{(1)} s_j^{(2)} - s_i^{(1)} g_j^{(2)},$$

$$g_{ik}^{(1,3)} = \sum_{j=1}^{n_2} w_j^{(2)} s_j^{(2)} G_{ijk} - g^{(0)} s_i^{(1)} s_k^{(3)} - g_i^{(1)} s_k^{(3)} - s_i^{(1)} g_k^{(3)},$$

$$g_{jk}^{(2,3)} = \sum_{i=1}^{n_1} w_i^{(1)} s_i^{(1)} G_{ijk} - g^{(0)} s_j^{(2)} s_k^{(3)} - g_i^{(1)} s_k^{(3)} - s_j^{(2)} g_k^{(3)}$$

In conclusion, the application of EMPR to 3-dimensional cubes enables the extraction of features, which can be explicitly represented by the EMPR component equations. These features can be readily utilized in subsequent machine learning or deep learning models, providing a valuable tool for data analysis and processing.

#### Principal Component Analysis

Principal Component Analysis (PCA) is a widely employed statistical technique utilized for dimensionality reduction and data visualization (Greenacre et al., 2022). Its fundamental objective is to transform a dataset consisting of possibly correlated variables into a set of linearly uncorrelated variables, known as principal components. These components are ordered such that the first principal component accounts for the maximum variance in the data, with subsequent components capturing decreasing amounts of variance. Mathematically, PCA involves the computation of eigenvectors and eigenvalues from the covariance matrix of the dataset.

Let  $X$  be the original data matrix, where  $X$  is an  $n \times p$  matrix, with  $n$  samples and  $p$  features. The covariance matrix  $\Sigma$  can be calculated as:

$$\Sigma = \frac{(X - \bar{X})(X - \bar{X})^T}{(n - 1)}$$

where  $\bar{X}$  is the mean vector of  $X$ . The eigenvectors and eigenvalues of  $\Sigma$  are calculated as:

$$\Sigma V = V \Lambda$$

where  $V$  is the matrix of eigenvectors and  $\Lambda$  is the diagonal matrix of eigenvalues. The principal components are then obtained by projecting the original data onto the eigenvectors:

$$Y = XV$$

where  $Y$  is the matrix of principal components. By selecting a subset of the top-ranked principal components, PCA enables the identification of the most informative features in the data, facilitating the visualization and analysis of high-dimensional datasets.

### *Support Vector Machines*

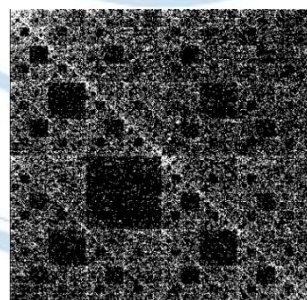
In multi-dimensional classification scenarios, Support Vector Machines (SVM) remain a powerful tool for discerning complex decision boundaries. SVMs are particularly well-suited for addressing a variety of classification problems due to their ease of use and flexibility. As a result, they are able to provide balanced predictive performance, even in situations where the sample size is limited (Pisner et al., 2020). It is efficacy in high-dimensional cases, making it a powerful tool for handling complex data sets. Additionally, SVMs are efficient in terms of memory usage, as they only require a subset of the training points, known as support vectors, to make predictions. This efficient memory usage makes SVMs a practical choice for large-scale machine learning applications. Furthermore, SVMs offer flexibility in terms of kernel functions, allowing users to specify different kernel functions or even custom kernels to suit their specific needs.

Kernel methods are a type of machine learning algorithm that allows for the use of non-linear decision boundaries in a linearly inseparable dataset. This is achieved by mapping the original data into a higher-dimensional space, where the data becomes linearly separable. Common kernel functions include linear, polynomial, radial basis function (RBF), and sigmoid. The choice of kernel function depends on the specific problem and data characteristics.

The goal of SVMs is to find the optimal hyperplane that maximizes the distance between different classes while minimizing mistakes. This is typically done by solving a quadratic programming (QP) problem, where the objective function is the margin between the classes, and the constraints are the linear inequalities that define the hyperplane. The optimization problem can be formulated as a linear or quadratic program, and solved using various algorithms.

### **RESULTS**

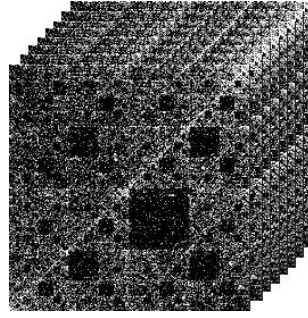
The comprehensive model is constructed by integrating the methods outlined in the previous section. Initially, the gene datasets for mTOR and TGF- $\beta$  are processed to obtain the necessary gene data. Subsequently, the CGR algorithm is implemented with specific parameters. The CGR size is set to  $400 \times 400$ , and the initial point is chosen as (200, 200). The nucleotides Adenine, Guanine, Cytosine, and Thymine are positioned at the coordinates (0, 0), (400, 0), (0, 400), and (400, 400), respectively. For each gene, a 2D image is generated from the 1D input data. Figure 4 illustrates an example of the CGR representation for a single gene.



**Figure 4.** CGR example of a gene from mTOR gene network

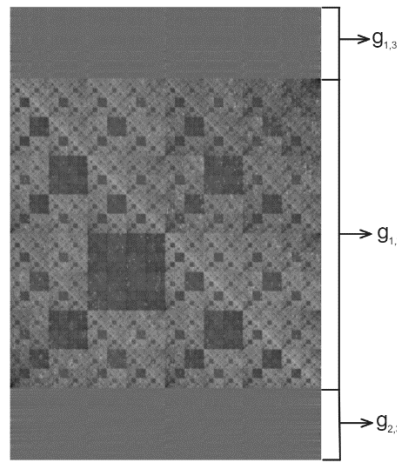
Following the creation of all CGR images, the images are concatenated in gene order to form a 3D CGR cube. Figure 5 illustrates an example of an appropriate 3D cube representation.





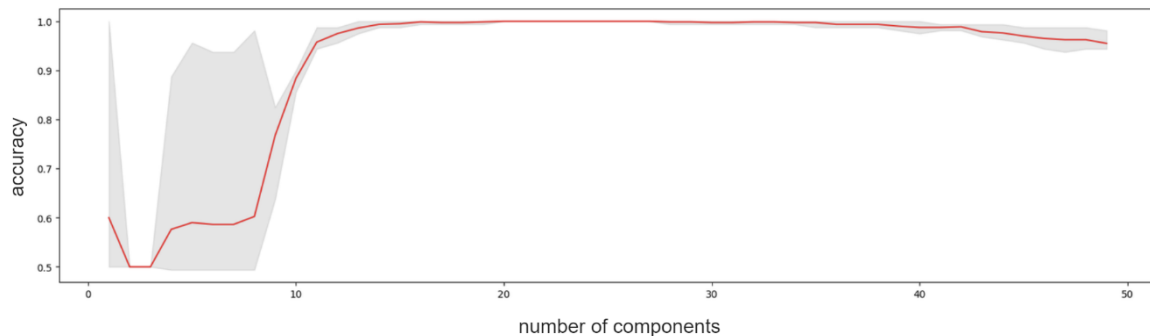
**Figure 5.** CGR cube representation of an mTOR gene network

Subsequently, the EMPR method is applied to the 3D output cube generated by the CGR algorithm, resulting in lower-dimensional data that effectively represents the cube. The three 2D EMPR components are then concatenated together. Figure 6 shows the outcome of this concatenation process.

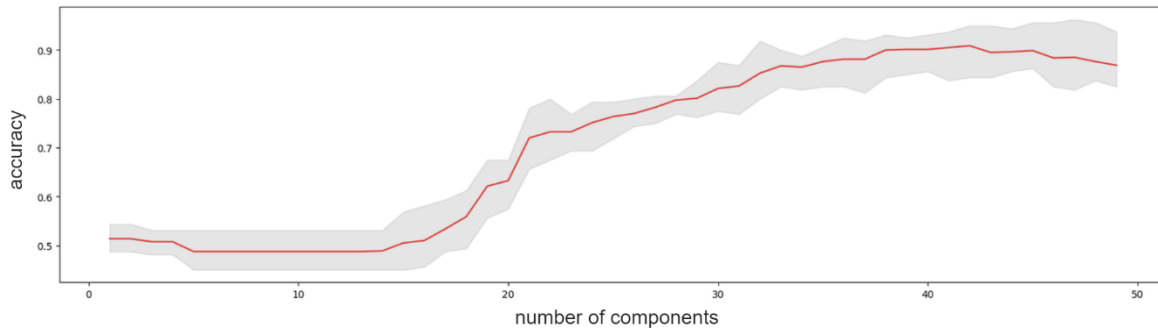


**Figure 6.** Resulting 2-D array of concatenation EMPR components

Using the 2D image created earlier, Principal Component Analysis (PCA) is employed to reduce the dimensionality of the data. Starting with the component exhibiting the highest variance in the PCA response, the components are selected and added sequentially. The accuracy of each selection is evaluated by applying a Support Vector Machine (SVM) algorithm with a linear kernel and 5-fold cross-validation. The accuracy scores for the mTOR and TGF- $\beta$  datasets are depicted in Figures 7 and 8, respectively, as a function of the selection component size. The gray area represents the cross-validation results, while the red line indicates the average of these outcomes.



**Figure 7.** Accuracy plot for mTOR dataset



**Figure 8.** Accuracy plot for TGF- $\beta$  dataset

The accuracy exhibits a dramatic increase as the number of components used increases. Notably, the mTOR dataset, comprising 31 genes, achieves a maximum accuracy of 99%, while the TGF- $\beta$  dataset, comprising 93 genes, reaches an accuracy above 90%.

## DISCUSSION AND CONCLUSION

The use of high-dimensional computer modeling for gene networks and network-specific gene variant analysis in a comprehensive manner seems reasonable and reliable based on the findings and observations achieved. Due to the promising results, the suggested methodology to diploid sequencing data in order to undertake future research that is more in-depth.

## References

- Dehghan, A., 2018. Genome-Wide Association Studies, Springer New York, New York, NY, s.37–49.
- Choobdar, S., Ahsen, M.E., Crawford, J., Tomasoni, M., Fang, T., Lamparter, D., Lin, J., Hescott, B., Hu, X., Mercer, J., Natoli, T., Narayan, R., Subramanian, A., Zhang, J.D., Stolovitzky, G., Kutalik, Z., Lage, K., Slonim, D.K., Saez-Rodriguez, J., Cowen, L.J., Bergmann, S. Ve Marbach, D., 2019. Assessment of network module identification across complex diseases, *Nature Methods*, 16(9), 843–852.
- Hawe, J.S., Theis, F.J. ve Heinig, M., 2019. Inferring Interaction Networks From Multi-Omics Data, *Frontiers in Genetics*, 10.
- Choi, S.W., Mak, T.S.H. ve O'Reilly, P.F., 2020. Tutorial: a guide to performing polygenic risk score analyses, *Nature Protocols*, 15(9), 2759–2772.
- Jeffrey, H., 1990. Chaos game representation of gene structure, *Nucleic Acids Research*, 18(8), 2163–2170.
- Almeida, J.S., Carriço, J.A., Marezek, A., Noble, P.A. ve Fletcher, M., 2001. Analysis of genomic sequences by Chaos Game Representation, *Bioinformatics*, 17(5), 429–437.
- Tunga, B. ve Demiralp, M., 2010. The influence of the support functions on the quality of enhanced multivariate product representation, *Journal of Mathematical Chemistry*, 48(3), 827–840.
- Fink, E.L., 2009. The FAQs on Data Transformation, *Communication Monographs*, 76(4), 379–397.
- Abdi, H. ve Williams, L.J., 2010. Principal component analysis, *WIREs Computational Statistics*, 2(4), 433–459.
- Hearst, M., Dumais, S., Osuna, E., Platt, J. ve Scholkopf, B., 1998. Supportvector machines, *IEEE Intelligent Systems and their Applications*, 13(4), 18–28.
- Pisner, D.A. ve Schnyer, D.M., 2020. Support vector machine, Elsevier, s.101–121.
- Wullschleger, S., Loewith, R. ve Hall, M.N., 2006. TOR Signaling in Growth and Metabolism, *Cell*, 124(3), 471–484.
- Tzavlaki, K. ve Moustakas, A., 2020. TGF- Signaling, *Biomolecules*, 10(3), 487.
- Browne, M.W., 2000. Cross-Validation Methods, *Journal of Mathematical Psychology*, 44(1), 108–132.
- Tuna, S., Gulec, C., Yucesan, E., Cirakoglu, A. ve Tarkan-Argüden, Y., 2022. Gene Teams are on the Field: Evaluation of Variants in Gene-Networks Using High Dimensional Modelling

- Tuna, S., Toreyin, B.U., Demiralp, M., Ren, J., Zhao, H. ve Marshall, S., 2021. Iterative Enhanced Multivariance Products Representation for Effective Compression of Hyperspectral Images, IEEE Transactions on Geoscience and Remote Sensing, 59(11), 9569–9584.
- Kolda, T.G. ve Bader, B.W., 2009. Tensor Decompositions and Applications, SIAM Review, 51(3), 455–500.
- Greenacre, M., Groenen, P.J.F., Hastie, T., D’Enza, A.I., Markos, A. ve Tuzhilina, E., 2022. Principal component analysis, Nature Reviews Methods Primers, 2(1).

**Conflict of Interest**

The authors have declared that there is no conflict of interest.





## Applying the Generalized Normal Distribution for Modelling Asset Returns Data

Christos P. Kitsos<sup>1</sup>, Nyamsi Ulrich Eschol<sup>2\*</sup>

<sup>1</sup>University of West Attica, Department of Informatics and Computer Engineering, Athens, Greece

<sup>2</sup>Universidade Aberta, Department of Science and Technology, Lisbon, Portugal

\*Corresponding author e-mail: xkitsos@uniwa.gr

### Abstract

*There is a need, especially for the data from Economical studies, to work with “fat tailed” distributions. Not only from the definition we provided, but from the evaluation of the appropriate values the  $\gamma$ -order Generalized Normal ( $\gamma$ -GN) offers a solution to this problem, defined, with the extra, shape, parameter  $\gamma$ . The MLE can be evaluated, the Fisher’s information matrix is evaluated, so that the variance covariance matrix, for the particular value of the shape parameter can be estimated. Data have been downloaded from Yahoo Finance for different NYSE Stocks. The datasets has been analyzed and the results are presented and discussed appropriately.*

**Keywords:** Multivariate Normal,  $\gamma$ -order Generalized Normal, Fat Tailed Distribution.

### INTRODUCTION

In the ever-evolving field of Financial Econometrics, modeling asset returns is a necessity for Risk Management and strategic investment decision-making. Asset return distributions are renowned for their deviations from the classical Normal distribution (Te’dongap & Tinang, 2022; Holte, 2024). Leptokurtic distributions exhibit more frequent extreme events, both positive and negative, than would be expected under a Gaussian framework, leading to an underestimation of risk if not properly modeled (De Domenico et al., 2023).

Kitsos and Tavouraris (2014) introduced and studied a three parameter generalization of the multivariate Normal distribution,  $\gamma$ -GN, with the introduction of the shape parameter  $\gamma$ . In the context of asset returns, where leptokurtosis can have profound implications for portfolio construction, risk assessment, and regulatory compliance, the flexibility offered by the  $\gamma$ -GN, also denoted  $N_\gamma(\mu, \Sigma)$ , stands out as particularly salient.

This empirical study leverages on the  $\gamma$ -GN to model the return distributions of various assets and adapt it to calibrate and capture the leptokurtic nature of asset returns, reflecting the true risk profile more faithfully than traditional models. Thus, the shape parameter is crucial for “fat tailed” distribution. Through this lens, the study aims to provide a more accurate modelling of asset returns.

### THE $\gamma$ -GENERALIZED NORMAL DISTRIBUTION

The Generalized  $\gamma$ -order Normal Distribution ( $\gamma$ -GN) parameters typically include the location ( $\mu$ ), scale ( $\sigma$ ), and the shape parameter ( $\gamma$ ). The shape parameter  $\gamma$  adjusts the distribution’s kurtosis, allowing for greater flexibility in modeling tail behavior compared to the standard normal distribution. The location parameter  $\mu$  determines the center, and the scale parameter  $\sigma$  affects the spread of the distribution. The distribution function of the  $\gamma$ -GN,  $f_\gamma$ , is defined as:

$$f_\gamma(x; \mu, \Sigma) = C_\gamma^p(\sigma) \exp\left\{-\frac{\gamma-1}{\gamma} [Q_\theta(x)]^{\frac{\gamma}{2(\gamma-1)}}\right\}, \quad x \in R^p, \quad (1)$$

with the normalization constant

$$C_\gamma^p(\Sigma) = \pi^{-p} |\Sigma|^{-1/2} \xi_\gamma^p \left(\frac{\gamma-1}{\gamma}\right)^{p \frac{\gamma-1}{\gamma}}, \quad \text{and} \quad Q_\theta(x) = (x - \mu) \Sigma^{-1} (x - \mu)^T,$$

$$\xi_Y^p = \frac{\Gamma(p/2+1)}{\Gamma((p(\gamma-1)/\gamma+1)}, \quad \text{and the parameter vector } \vec{\theta} = (\mu, \Sigma, \gamma) \in R^{p \times (p \times p) \times p}$$

We notice that when  $\gamma$  is assumed known, the unknown parameter  $\theta$  is reduced to  $(\mu, \Sigma)$ .

The following theorem holds (see Kitsos et al., 2011a)

Theorem 2.1 The multivariate  $\gamma$ -GND r.v.  $X$ , i.e.,  $X \sim N_\gamma(\mu, \sigma^2)$  with p.d.f.  $f_X$ , coincides for different values of the shape parameter  $\gamma$  with the Uniform, Normal, Laplace, and Dirac distributions, as

$$f_\gamma(x) = \begin{cases} f_D & \text{for } \gamma = 0 \text{ and } p = 1, 2 \\ 0 & \text{for } \gamma = 0 \text{ and } p \geq 3 \\ f_U & \text{for } \gamma = 1 \\ f_N & \text{for } \gamma = 2 \\ f_L & \text{for } \gamma = \pm\infty. \end{cases} \quad (2)$$

In this paper, we consider the univariate case :  $p = 1$ .

The cumulative distribution function (c.d.f) of  $N_\gamma(\mu, \sigma^2)$  has been evaluated as the in following theorem (see Kitsos et al., 2014a).

Theorem 2.2 The c.d.f.  $F_X(x)$  of a  $\gamma$ -order normally distributed random variable  $X \sim N_\gamma(\mu, \sigma^2)$  is given by

$$F_X(x) = \frac{1}{2} + \frac{2}{\pi} \Gamma\left(\frac{\gamma-1}{\gamma}\right) \Gamma\left(\frac{\gamma}{\gamma-1}\right) \text{Erf}_{\frac{\gamma}{\gamma-1}}\left(\left(\frac{\gamma-1}{\gamma}\right)^{\frac{\gamma-1}{\gamma}} \frac{x-\mu}{\sigma}\right) \quad (3)$$

$$= 1 - \frac{1}{2\Gamma\left(\frac{\gamma-1}{\gamma}\right)} \Gamma\left(\frac{\gamma-1}{\gamma}, \frac{\gamma-1}{\gamma} \left(\frac{x-\mu}{\sigma}\right)^{\frac{\gamma}{\gamma-1}}\right) \quad \text{for } x \in R \quad (4)$$

Table 1 provides the probability values  $F_X(x) = \Pr\{X \leq x\}$ , for various values of  $x$ , when  $X \sim N_\gamma(0, 1)$  (Kitsos, et al., 2014a).

Table 1: Probability mass values  $F_X(x)$  for various  $x \in R$ , for certain r.v.  $X_\gamma \sim N_\gamma(0, 1)$ .

$\gamma$	$F_X(-3)$	$F_X(-2)$	$F_X(-1)$	$F_X(1)$	$F_X(2)$	$F_X(3)$
-50	0.0260	0.0690	0.1846	0.8154	0.9310	0.9740
-10	0.0304	0.0742	0.1869	0.8131	0.9258	0.9696
-5	0.0357	0.0802	0.1895	0.8105	0.9198	0.9643
-2	0.0502	0.0950	0.1958	0.8042	0.9050	0.9498
-1	0.0699	0.1131	0.2030	0.7970	0.8869	0.9301
-1/2	0.0970	0.1361	0.2116	0.7884	0.8639	0.9030
-1/10	0.1656	0.1889	0.2299	0.7701	0.8111	0.8344
1	0.	0.	0.	1.	1.	1.
2	0.0013	0.0228	0.1587	0.8413	0.9772	0.9987
3	0.0071	0.0402	0.1699	0.8301	0.9598	0.9929
4	0.0112	0.0480	0.1742	0.8258	0.9520	0.9888
5	0.0138	0.0523	0.1765	0.8235	0.9477	0.9862
10	0.0193	0.0604	0.1805	0.8195	0.9396	0.9807
50	0.0238	0.0663	0.1833	0.8167	0.9337	0.9762
$\pm\infty$	0.0249	0.0677	0.1839	0.8161	0.9323	0.9751

We note that in Table 1, for  $\gamma = 2$ , the classical case of the standard normal distribution is considered. For "large" value of  $\gamma$  (i.e.,  $\gamma = 50$ ), the Laplace distribution is approached, while for  $\gamma \rightarrow 1$ , the uniform distribution is considered. It is clear that for different  $\gamma \in R - [0, 1]$  is associated to different size of the tails.

## MAXIMUM LIKELIHOOD ESTIMATION

Parameter estimation for the generalized  $\gamma$ -order normal distribution involves estimating the mean vector  $\mu$ , the covariance matrix  $\Sigma = I\sigma^2$ , and the shape parameter  $\gamma$ . The estimation can be performed using Maximum Likelihood Estimation (MLE), or other suitable estimation techniques that account for the additional complexity introduced by the  $\gamma$  parameter.

Given a sample  $X = \{X_1, X_2, \dots, X_n\}$  drawn from  $N_\gamma(\mu, I\sigma^2)$ , the likelihood function  $L(\mu, \Sigma, \gamma|X)$  can be formulated based on the probability density function of the generalized  $\gamma$ -order normal distribution. The MLE estimates  $\hat{\mu}$ ,  $\hat{\sigma}$ , and  $\hat{\gamma}$  are obtained by maximizing this likelihood function:

$$\hat{\theta} = (\hat{\mu}, \hat{\sigma}, \hat{\gamma}) = \underset{\mu, \Sigma, \gamma}{\operatorname{argmax}} L(\mu, \sigma, \gamma|X) \quad (5)$$

Given the definition of the  $\gamma$ -GN for  $p = 1$ , we have:

$$f_\gamma(x; \mu, \sigma) = C_\gamma^1(\sigma) \exp \left\{ -\frac{\gamma-1}{\gamma} \left[ \frac{(x-\mu)^2}{\sigma^2} \right]^{\frac{\gamma}{2(\gamma-1)}} \right\} \quad (6)$$

The likelihood function for a sample  $x_1, x_2, \dots, x_n$  is the product of the PDF values:

$$L(\mu, \sigma, \gamma|x) = \prod_{i=1}^n C_\gamma^1(\sigma) \exp \left\{ -\frac{\gamma-1}{\gamma} \left[ \frac{(x_i-\mu)^2}{\sigma^2} \right]^{\frac{\gamma}{2(\gamma-1)}} \right\} \quad (7)$$

The log-likelihood function is given by:

$$l(\mu, \sigma^2; X) = n \log C_\gamma^1 - \frac{n}{2} \log \sigma^2 - \frac{\gamma-1}{\gamma} \sigma^{-\frac{\gamma}{\gamma-1}} \sum_{i=1}^n |X_i - \mu|^{\frac{\gamma}{\gamma-1}} \quad (8)$$

The MLE of  $\sigma$ , denoted  $\hat{\sigma}$ , when  $\gamma$  is known, is found by differentiating the log-likelihood function with respect to  $\mu$  and  $\sigma^2$ , and setting these derivatives to zero.

The partial derivative of the log-likelihood function with respect to  $\mu$  is given by (Kitsos et al., 2014a):

$$\frac{\partial l}{\partial \mu}(\mu, \sigma^2) = \sigma^{-\frac{\gamma}{\gamma-1}} \sum_{i=1}^n \operatorname{sgn}(X_i - \mu) (X_i - \mu)^{1/(\gamma-1)} \quad (9)$$

where  $\operatorname{sgn}$  is the sign function.

Its second partial derivative with respect to  $\mu$ , is given by:

$$\frac{\partial^2 l}{\partial \mu^2}(\mu, \sigma^2) = -\frac{1}{\gamma-1} \sigma^{-\frac{\gamma}{\gamma-1}} \sum_{i=1}^n |X_i - \mu|^{\frac{2-\gamma}{\gamma-1}} \quad (10)$$

The partial derivative of the log-likelihood function with respect to  $\sigma^2$  is given by (Kitsos et al., 2014a):

$$\frac{\partial l}{\partial \sigma^2}(\mu, \sigma^2) = -\frac{n}{2\sigma^2} + \frac{1}{2} \sigma^{\frac{2-3\gamma}{\gamma-1}} \sum_{i=1}^n |X_i - \mu|^{\frac{\gamma}{\gamma-1}} \quad (11)$$

and its second-order derivative is:

$$\frac{\partial^2 l}{(\partial \sigma^2)^2}(\mu, \sigma^2) = \frac{n}{2\sigma^4} + \frac{2-3\gamma}{4(\gamma-1)} \sigma^{\frac{4-5\gamma}{\gamma-1}} \sum_{i=1}^n |X_i - \mu|^{\frac{\gamma}{\gamma-1}} \quad (12)$$

The cross partial derivative with respect to  $\mu$  and  $\sigma^2$ , is:

$$\frac{\partial^2 l}{\partial \mu \partial \sigma^2}(\mu, \sigma^2) = -\frac{\gamma}{2(\gamma-1)} \sigma^{\frac{2-3\gamma}{\gamma-1}} \sum_{i=1}^n \operatorname{sgn}(X_i - \mu) (X_i - \mu)^{\frac{1}{\gamma-1}} \quad (13)$$



The derivative with respect to  $\sigma^2$  and setting it equal to zero gives us the following equation:

$$\hat{\sigma}_\gamma^2 = \left( \frac{1}{n} \sum_{i=1}^n |X_i - \mu|^{\frac{\gamma}{\gamma-1}} \right)^{\frac{2(\gamma-1)}{\gamma}} \quad (14)$$

This is the MLE of  $\sigma^2$  for known  $\gamma$  in the univariate case of the  $\gamma$ -order generalized normal distribution.  $\sigma^2$  depends on the shape parameter  $\gamma$  and it is different than the typical  $\sigma^2$ , thus the construction of the confidence intervals needs a further consideration.

The following two propositions provide the estimation of the  $n$ -th raw moments.

Proposition 3.1 The  $n$ -th raw moments  $\alpha_n$  of the standard univariate  $N_\gamma(0, 1)$  are given by:

$$\alpha_n = E(X^n) = \begin{cases} 0 & , n = 2k + 1, k \in \mathbb{N}, \\ \left(\frac{\gamma}{\gamma-1}\right)^{2k} \frac{\Gamma\left(\frac{(2k+1)(\gamma-1)}{\gamma}\right)}{\Gamma\left(\frac{\gamma-1}{\gamma}\right)} & , n = 2k, k \in \mathbb{N}, \end{cases} \quad (15)$$

(Kitsos & Toulas, 2011b)

Proposition 3.2 The  $n$ -th raw moments  $\beta_n$  of the random variable  $X \sim N_\gamma(\mu, \sigma^2)$  are given by:

$$\beta_n = E(X^n) = \sum_{r=0}^n \binom{n}{r} \mu^r \sigma^{n-r} \left(\frac{\gamma}{\gamma-1}\right)^n \frac{\Gamma^{n-r}\left(\frac{\gamma-1}{\gamma}\right)}{\Gamma^{n-r}\left(\frac{\gamma-1}{\gamma}\right)}, \quad (16)$$

(Kitsos & Toulas, 2011b)

Proposition 3.3 The variance ( $\text{Var}(Y)$ ) and kurtosis ( $\text{Kurt}(Y)$ ) of a random variable  $Y$  following  $\gamma$ -ordered Normal distribution are given by :

$$\text{Var}(Y) = \left(\frac{\gamma}{\gamma-1}\right) \frac{\Gamma\left(3\frac{\gamma-1}{\gamma}\right)}{\Gamma\left(\frac{\gamma-1}{\gamma}\right)} \sigma^2 \quad (17)$$

and

$$\text{Kurt}(Y) = \frac{\Gamma\left(\frac{\gamma-1}{\gamma}\right) \Gamma\left(5\frac{\gamma-1}{\gamma}\right)}{\Gamma^2\left(3\frac{\gamma-1}{\gamma}\right)} - 3 \quad (18)$$

(Kitsos & Toulas, 2011b)

These above relations (17) and (18) express how the variance and kurtosis of the distribution depend on the parameter  $\gamma$  and the scale parameter  $\sigma$ . The variance formula shows the relationship between  $\gamma$ , the scale of the distribution ( $\sigma^2$ ), and the Gamma function, indicating how variance changes with different orders of  $\gamma$ . The kurtosis formula, which also relies on  $\gamma$  and the Gamma function, demonstrates how the "tailedness" of the distribution varies with  $\gamma$ .

Let  $X \sim N_\gamma(\mu, \sigma^2)$ . Then for  $Z = (X - \mu)/\sigma$  it holds that  $Z \sim N_\gamma(0, 1)$ . Therefore we shall estimate the shape parameter of the standard  $\gamma$ -order normal. We first observe the following.

The asymptotic matrix of variance of the maximum likelihood estimators, i.e. the inverse of the Fisher's information matrix is given by (Kitsos, et al., 2014a):

$$I_\gamma^{-1} = \begin{bmatrix} \frac{\sigma^2(\gamma-1)\Gamma\left(1-\frac{1}{\gamma}\right)}{\Gamma\left(\frac{1}{\gamma}\right)} \left(\frac{\gamma}{\gamma-1}\right)^{\gamma-2} & 0 & 0 \\ 0 & \frac{\sigma^2(\gamma-1)^5}{\gamma} \left(1 + \frac{A_\gamma}{B_\gamma}\right) & \frac{\sigma\gamma(\gamma-1)^3 A_\gamma}{B_\gamma} \\ 0 & \frac{\sigma\gamma(\gamma-1)^3 A_\gamma}{B_\gamma} & \frac{\gamma(\gamma-1)}{B_\gamma} \end{bmatrix} \quad (19)$$

where  $A_\gamma$  and  $B_\gamma$  are defined as:

$$A_{\gamma} = \left[ -\log\left(1 - \frac{1}{\gamma}\right) + \psi\left(2 - \frac{1}{\gamma}\right) \right]^2$$

$$B_{\gamma} = \left(2 - \frac{1}{\gamma}\right) \psi'\left(2 - \frac{1}{\gamma}\right) - 1$$

$\psi(\cdot)$  is the digamma function, and  $\psi^j(\cdot)$  is the trigamma function.

We calculate the Fisher's Information matrixes for different values of  $\gamma$  and  $\sigma = 1$ .

$$I_{-3.4}^{-1} = \begin{bmatrix} 0.9021 & 0 & 0 \\ 0 & 709.3407 & 133.9270 \\ 0 & 133.9270 & 60.1903 \end{bmatrix}, \quad I_{-2}^{-1} = \begin{bmatrix} 0.75 & 0 & 0 \\ 0 & 169.1655 & 21.1846 \\ 0 & 21.1846 & 26.5611 \end{bmatrix}$$

$$I_{-1.1}^{-1} = \begin{bmatrix} 0.1753 & 0 & 0 \\ 0 & 48.2798 & 3.0597 \\ 0 & 3.0597 & 12.0855 \end{bmatrix}, \quad I_{1.1}^{-1} = \begin{bmatrix} 0.9898 & 0 & 0 \\ 0 & 0.0001 & 0.0073 \\ 0 & 0.0073 & 0.1889 \end{bmatrix}$$

$$I_2^{-1} = \begin{bmatrix} 1 & 0 & 0 \\ 0 & 1.1618 & 2.6473 \\ 0 & 2.6473 & 4.9726 \end{bmatrix}, \quad I_{3.4}^{-1} = \begin{bmatrix} 1.0127 & 0 & 0 \\ 0 & 44.6913 & 42.6914 \\ 0 & 42.6914 & 23.5073 \end{bmatrix}$$

The range and magnitude of the elements in  $I_{\gamma-1}$  across various  $\gamma$  values highlight the impact of the distribution's tail behavior on the estimation of its parameters.

For distributions with large value of  $|\gamma|$ , the heavy tails lead to significant uncertainties in parameter estimates, particularly for the scale and shape parameters.

However, as positive values of  $\gamma$  becomes very large, uncertainties increase again, but less intensely than with the negative values of  $\gamma$ .

Around  $\gamma = 2$ , the estimability becomes more robust and aligns with classical statistical expectations.

We computed the eigenvalues of the inverse Fisher Information matrixes  $I_{\gamma-1}$  across different values of  $\gamma$  for the  $\gamma$ -GN. Table 2 presents the evaluation of the eigenvalues  $\lambda_1$ ,  $\lambda_2$  and  $\lambda_3$  of the above Fisher's Information matrixes. The determinants and the trace of each matrixe can be easily evaluated.

Table 2. Eigenvalues, Determinants and Traces of the inverse Fisher's Information matrixes across different values of  $\gamma$

$\gamma$	$\lambda_1$	$\lambda_2$	$\lambda_3$	Det	Trace
-3.4	735.89	33.65	3.63	89872.66	773.16
-2	172.25	23.48	3.80	15356.31	199.52
-1.1	48.54	11.83	1.30	747.22	61.67
1.1	0.19	0.11	-0.00018	-3.94e - 06	0.30
2	6.33	1	-0.19	-1.23	7.13
3.4	78.09	1.65	-9.89	-1273.08	69.85

## DATA

Data have been downloaded from Yahoo Finance for four New York Stock Exchange Stocks: AAPL and GOOGL. AAPL is the stock ticker for Apple Inc., GOOGL stands for Alphabet Inc., the parent company of Google.

Daily returns have been calculated from raw data covering the period from 01-05-2006 to 30-12-2010.

**RESULTS**

The time series plots for the returns of two different stocks show the volatility in the stock prices over time.

**APPLICATION**

AAPL: Displays periods of high volatility, particularly noticeable during 2008 which aligns with the financial crisis.

GOOGL : Similar to AAPL, shows increased volatility around 2008, with some spikes that suggest significant one-day returns.

Both AAPL and GOOGL show periods of high volatility, indicated by the vertical spikes in the returns. This suggests there were days with significant price movements. For both stocks, the volatility seems to have periods of clustering, where high volatility days are grouped together.

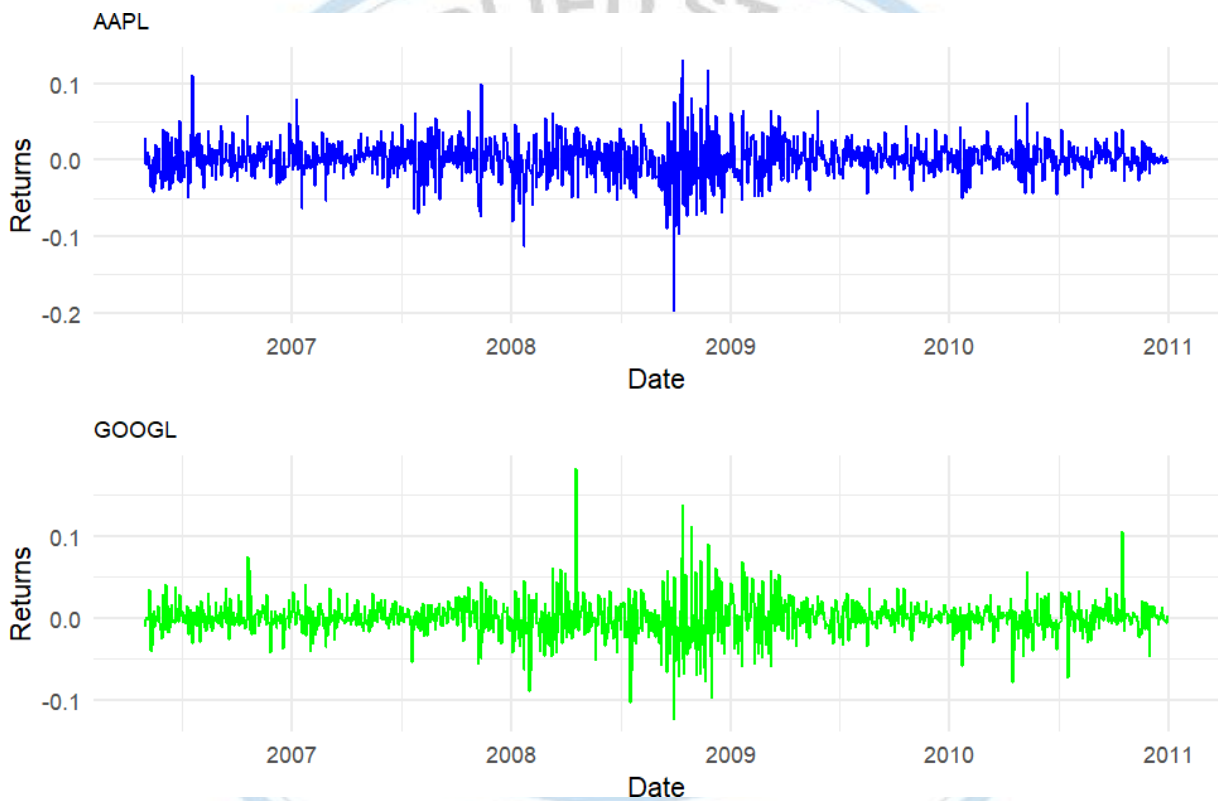


Figure 1: Time series of the returns of stock assets, from 01-05-2006 to 30-12-2010

Table 3: Estimated  $\theta$  for the distribution of return assets

Asset	AAPL	GOOGL
$\hat{\mu}$	0.0013	0.0003
$\hat{\sigma}^2$	0.004	0.0002
$\hat{\gamma}$	3.7	5.9

The figures 2 and 3 provide density plots for the asset returns compared to a normal distribution and a fitted  $\gamma$ -GN. The density plot for AAPL shows that both the  $\gamma$ -GN is closely fitted to the real data.

The mean return for AAPL is higher than that for GOOGL, indicating that AAPL had a higher average daily return during the observed period. This could suggest higher profitability or investor



confidence in AAPL compared to GOOGL, but also potentially higher volatility. In fact, the variance of returns for AAPL is significantly higher than that for GOOGL. This implies that AAPL's returns are more spread out around the mean, indicating higher volatility.

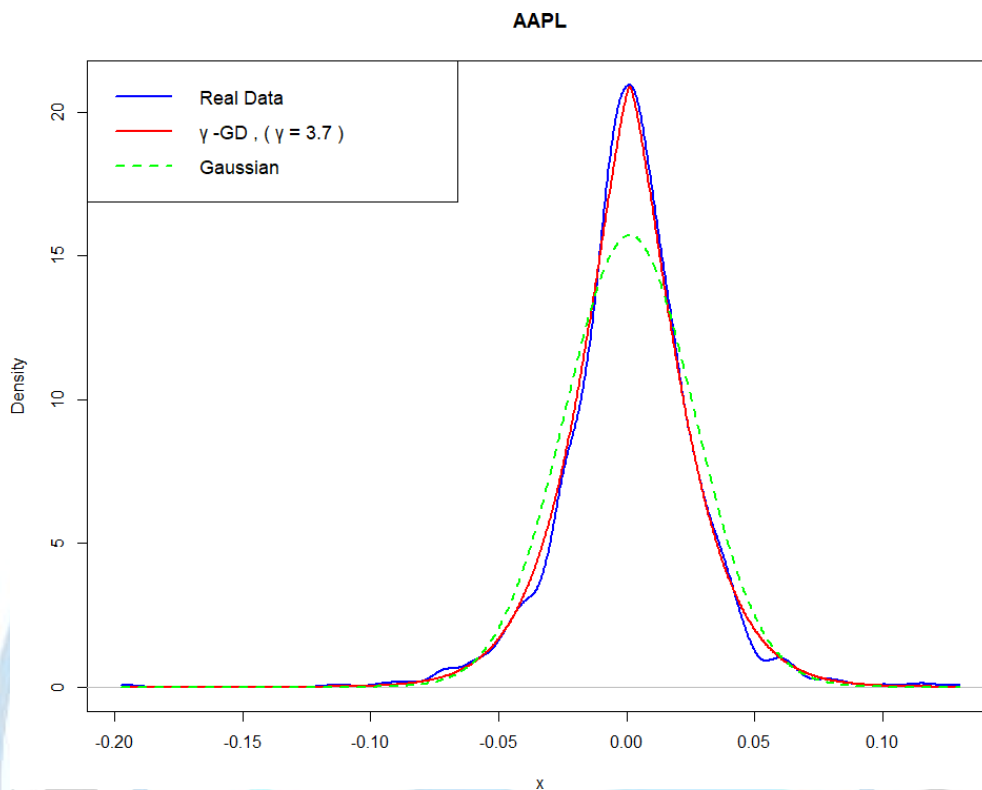


Figure 2: Probability Density of the Daily Returns for AAPL.

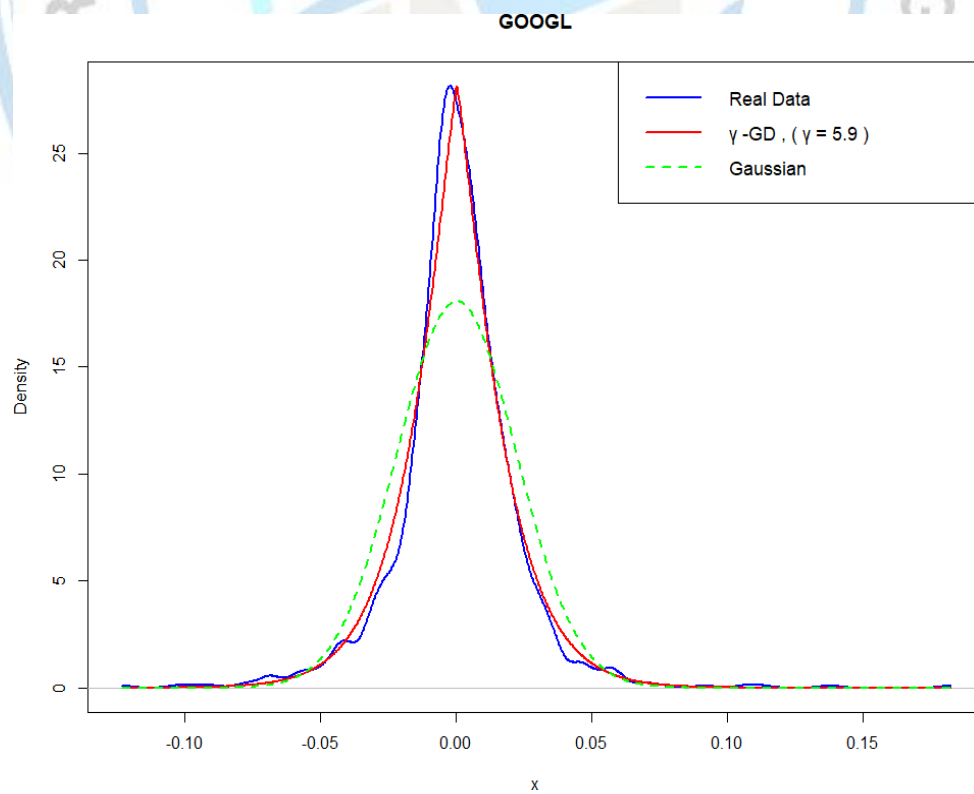


Figure 3: Probability Density of the Daily Returns for GOOGL

The shape parameter ( $\gamma$ ) for both stocks, indicates a leptokurtic distribution. The  $\gamma$  value of 3.7 indicates a distribution that has lighter tails than a normal distribution. This suggests that the returns are more prone to producing outliers than a normal distribution. The higher  $\gamma$  for GOOGL (5.9 compared to 3.7 for AAPL) suggests that GOOGL's return distribution is even more peaked than AAPL's. The GOOGL plot also shows that the  $\gamma$ -GND provides a closer fit to the real data, particularly at the tails. However, the distribution appears a little skewed to the right.

The  $\gamma$ -GND seems to provide a better fit for the asset returns than the normal distribution, particularly around the peaks and tails. These findings can have implications for risk assessment and financial modeling, as the tail behavior of the return distributions is crucial for estimating the likelihood of extreme events. The  $\gamma$ -GND can potentially provide a more accurate representation of the underlying risks in the asset returns.

## DISCUSSION AND LIMITATIONS

The estimation of parameters for the  $\gamma$ -GN distribution poses additional challenges due to the non-standard form of the distribution and the inclusion of the shape parameter  $\gamma$ . Numerical optimization and simulation-based methods like Markov Chain Monte Carlo (MCMC) can be utilized to address these challenges.

The coefficient  $\left(\frac{\gamma}{\gamma-1}\right)^{\frac{\gamma}{\gamma-1}}$  plays a crucial role in the Logarithm Sobolev Inequality, recognized as an international constant. It facilitates the calculations involved in  $\gamma$ -GN and enables the representation of various well-known distributions within the  $\gamma$ -GN family.

This analysis is based on the mathematical characterization of stock return distributions and should be integrated with broader financial analysis for investment decisions.

One of the primary limitations is the static nature of the  $\gamma$  parameter. In the real-world, financial markets are dynamic, and the underlying data-generating processes may change over time. The assumption of a constant  $\gamma$  may not capture such non-stationarity in the tail behavior of asset returns. Another limitation is the scope of the data.

Furthermore, this analysis is based on the mathematical characterization of stock return distributions and should be integrated with broader financial analysis for investment decisions.

## CONCLUSION

The Generalized  $\gamma$ -Normal Distribution ( $\gamma$ -GN) is a significant advancement in the Statistical characterization of complex data distributions, transcending the boundaries of traditional normality. This paper has shown its adaptability in modelling asset returns. In addition to its application in Finance, the potential of the  $\gamma$ -GN extends to numerous other fields such as environmental science, bioinformatics, computer vision, and beyond. The shape parameter  $\gamma$  serves as a critical tool in fine-tuning the distribution to reflect the real-world behavior of datasets that exhibit significant skewness or kurtosis.

## References

- Devroye, L., 1986. Non-uniform random variate generation. Springer, New York, NY (USA).
- De Domenico, F., Livanc, G., Montagna, G., & Nicrosini, O., 2023. Modeling and Simulation of Financial Returns under Non-Gaussian Distributions. Available at <https://arxiv.org/abs/2302.02769>
- Holte, G., 2024. Diverging from the Norm: An Examination of Non-Normality and its Measurement in Asset Returns. Available at SSRN: <https://ssrn.com/abstract=4716713> or <http://dx.doi.org/10.2139/ssrn.4716713>
- Kitsos, C., Tavouraris, K. N., 2009. Logarithmic Sobolev Inequalities for Information Measures. IEEE TRANSACTIONS ON INFORMATION THEORY, Vol 55, 6, June 2009, 2554-2561
- Kitsos, C., Vassiliadis, V., T. Toulas., 2014a. MLE for the  $\gamma$ -order generalized normal distribution.

- Discussiones Mathematicae Probability and Statistics 34 (2014). 143–158 doi:10.7151/dmps.1168
- Kitsos, C. P., Toulas, T., Trandafir, P.C., 2011a. On the multivariate  $\gamma$ -order Normal Distributions. Far East Journal of Theoretical Statistics, 35 (2), 95-114.
- Kitsos, C. P., Toulas, T., 2011b. On the family of the  $\gamma$ -order generalized normal distributions. Far East Journal of Theoretical Statistics, 35 (2), 95-114.
- Te'dongap, R., Tinang, J., 2022. Portfolio Optimization and Asset Pricing Implications under Returns Non-Normality Concerns. Finance 2022/1 (Vol. 43), pages 47 - 94.
- Toulas, L., Kitsos, C., 2014b. On the the properties of the Generalized Normal Distribution. Discussiones Mathematicae Probability and Statistics 34 (2014) 35–49 doi:10.7151/dmps.1167
- Zarikas, V., Kitsos, C. P., 2015. Risk Analysis with Reference Class Forecasting Adopting Tolerance Regions. In: Theory and Practice of Risk Assessment, by Kitsos, C. P., Oliveira, T. A., Rigas, A., Gulati, S. (Eds), pg 235- 247. Springer.

#### Data Source

AAPL : <https://finance.yahoo.com/quote/AAPL/history> GOOGL:  
<https://finance.yahoo.com/quote/GOOGL/history>

#### Conflict of Interest

The authors have declared that there is no conflict of interest.





## Ahşap Malzeme Üretimi ve Kullanımında Sonlu Elemanlar Analizi Uygulamalarının Avantajları

**Göksu Sirin<sup>1\*</sup>**

<sup>1</sup>Tokat Gaziosmanpaşa Üniversitesi, Almus Meslek Yüksekokulu, Ormancılık ve Orman Ürünleri Programı, 60150, Tokat, Türkiye

\*Sorumlu yazar e-mail: goksu.sirin@gop.edu.tr

### Özet

Ahşap doğal, hücrelerden oluşan, polimer bazlı, higrotermal viskoelastik bir malzeme olarak nitelendirilebilir. Kendine has özellikleri nedeniyle yaygın olarak kullanılmaktadır. Ahşabın en uygun şekilde kullanılabilmesi için mekanik davranışlarının bilinmesi gerekmektedir. Mekanik özellikler karmaşıktır ve genellikle laboratuvar deneyleriyle belirlenmektedir. Anizotropik yapılı bir malzeme olan ahşabın mekanik davranışını etkileyen doğal ve çevresel faktörler araştırmaları zorlaştırabilmektedir. Ahşabın mekanik davranışlarının daha kesin bir şekilde tanımlanması ve anlaşılması için mikro düzeyden makro düzeye kadar incelenmesi gerekir. Kesin çözümlerin elde edilemediği birçok mühendislik problemi için günümüzde sayısal yaklaşımlara başvurulmaktadır. Sonlu Elemanlar Metodu (SEM) mühendislikte malzemelerin veya sistemlerin dış etkenlere karşı davranışlarının analizinde kullanılan sayısal bir yöntemdir. Son yıllarda SEM, katı ve akışkanlar mekaniği alanındaki fiziksel olayların analizinde ve alan problemlerinin çözümünde kullanılan yaygın bir teknik haline gelmiştir. Bilgisayarların kalitesinin ve güvenilirliğinin sürekli olarak iyileştirilmesi endüstriyel alanlarda yaygın olarak kullanılmalarını sağlamaktadır. SEM' i kullanan çok sayıda bilgisayar programı mevcuttur. SEM' in ana varsayımı, karmaşık alanların daha basit sonlu boyutlu öğelerin bir araya getirilmesiyle temsil edilmesidir. Karmaşık yapıların ve karmaşık malzemelerin SEM ile sayısal modellemesi, stres analizi ve arıza modellemesinde giderek daha fazla kullanılmaktadır. Anizotropik mekanik davranış analiz etmek için ahşap doku, nanometrik düzeyden daha büyük boyutlara kadar modellenerek birçok çalışma yapılmıştır. Bu çalışmalardan elde edilen verilere göre simülasyon sonuçları gerçekte gözlemlenen sonuçlarla iyi bir şekilde eşleşmektedir. Analistler, SEM aracılığı ile ahşap bileşenlere uygulanabilecek geniş bir modelleme yelpazesine sahiptir. En önemli faktör, her bir modelleme konseptinin yeteneklerinin bilinmesi ve eldeki probleme uygun seçimin yapılmasıdır. Hesaplama tekniğinin gelişmesiyle birlikte sayısal simülasyon, ahşabın mekanik özelliklerinin araştırılmasında ekonomik ve etkili bir yöntem haline gelmiştir. Modern mühendislik çalışmalarında amaç, modellerin test verileri aralığının ötesinde tahminler yapmak için kullanılabilmesidir. SEM simülasyonları, hızlı, daha az maliyetli ve daha optimize edilmiş ürünler geliştirmenin yanı sıra, çok ayrıntılı prototipler kullanılarak bile mümkün olmayan ürün performansının incelenmesine de olanak sağlayabilir. SEM' in hızla gelişmesiyle birlikte karmaşık geometrilere ve yüklemeye koşullarına sahip problemlere yeni bakış açıları oluşmaktadır. Materyallerdeki bozulmaların azaltılması ve mevcut olanı iyileştirmek için SEM, deneysel gözlem ve materyal karakterizasyonu birleştirilen güçlü bir yardımcıdır.

**Anahtar Kelimeler:** Ahşap Malzeme, Deneysel Analiz, Sonlu Elemanlar Analizi

### GİRİŞ

Ahşap doğal, hücresel, polimer bazlı, higrotermal viskoelastik bir malzeme olarak nitelendirilebilir. Anizotropik bir malzemedir ancak uygun koşullar altında (sayısal analizlerde) genellikle ortotropik olarak kabul edilir (Fakoor ve Khezri, 2020). Kendine has özellikleri nedeniyle yaygın olarak kullanılmaktadır. Ahşabın en uygun şekilde kullanılabilmesi için mekanik davranışlarının bilinmesi gerekmektedir. Mekanik özellikleri karmaşıktır çünkü zamana, sıcaklığa, neme veya yüklemeye oranına göre değişken davranışlar sergiler (Mackerle, 2005). Karmaşıklığa yol açan bir diğer neden de ahşapta doğal olarak bulunan kusurlardır. Ahşap ve ahşap ürünler çeşitli sebeplerle bozulabilen malzemelerdir. Ahşap ancak mikro düzeyden makro düzeye kadar incelendiğinde kusurlar ve bozulmaların azaltılması

(Ormarsson vd., 2009) ve mekanik davranışların anlaşılması hakkında sağlıklı bilgiler oluşur (Mackerle, 2005). Bu nedenle ahşap doku yapısı üzerine çok ölçekli sayısal modellerle birçok çalışma yapılmaktadır (Zhong vd., 2021). Neredeyse son elli yıldır Sonlu Elemanlar Metodu (SEM), yapı, katı ve akışkanlar mekaniği alanındaki fiziksel olayların analizinde ve alan problemlerinin çözümünde kullanılan yaygın bir teknik haline gelmiştir (Mackerle, 2005). SEM mühendislikte malzemelerin veya sistemlerin dış etkenlere (kuvvet, ısı, elektrik, vb.) karşı davranışlarının analizinde kullanılan nümerik bir yöntemdir (Güntekin ve Yılmaz, 2013). SEM' in ana önermesi, karmaşık alanların ayrıklaştırılabileceği ve daha basit sonlu boyutlu öğelerin bir araya getirilmesiyle temsil edilebileceğidir (Vasic vd., 2005). Var olan herhangi bir nesne sonsuz noktalardan meydana gelmektedir ancak bu metotta analizlerin yapılabilmesi için model sonlu sayıda noktaya ayrılır. Bu şekilde materyalin ya da tasarımın sonlu elemanlar modeli hazırlanarak bu model üzerinde çalışmalar yapılır (Gürer vd., 2008). Laboratuvar deneylerinde, yapılar bir bütün olarak ele alınan küresel yaklaşıma dayanmaktadır ancak maliyet, parametre sayıları gibi nedenlerle sınırlar vardır. Bilgisayar ortamında malzemeler ve yapılar kendi mekanik davranışlarına sahip temel bileşenlerin bir araya getirilmesi olarak ele alınır. Yani sürekli geometri sonlu sayıda hücreye bölünür ve her hücreye sınırlı sayıda düğüm atanır. Birimler düğümler aracılığıyla birbirine bağlanır. Bu sayede gerçek fiziksel sistem (Fu vd., 2017) örneğinin malzeme yönleri, sertlik ve mukavemet gibi malzeme özellikleri hakkında bilgi verildiğinde karmaşık anizotropik veya izotropik gövdelerin davranışını simüle edebilir (Huber vd., 2022). SEM, sürekli ortam mekaniği, ısı ve kütle transferi ve akışkanlar alanlarındaki problemler dahil olmak üzere çok çeşitli fiziksel durumları ve süreçleri modellemek için kullanılabilir (Vasic vd., 2005). Herhangi bir kuvvet altındaki yer değiştirme, gerilme, gerinim vb. etkiler bu düğümler aracılığıyla hesaplanabilir. Matematiksel çözümler yapılır. Gerçek sistemdeki bilinmeyenlerin yaklaşık değeri hesaplanabilir (Fu vd., 2017). Kullanılan sonlu elemanların boyutlarının ve şekillerinin değişkenliği nedeniyle ele alınan bir cismin geometrisi tam olarak temsil edilebilir. Bir veya birden çok delik veya köşeleri olan bölgeler kolaylıkla incelenebilir. Tek bir model birçok problemin çözümünde kullanılabilir. Elde edilecek sonuçların doğruluğu verilerin doğruluğuna bağlıdır. Grafikler, fotoğraflar ve tablolar halinde sonuçların görülmesi kolaylık sağlamaktadır (Şirin ve Aydemir, 2016).

#### AHŞAP ve SONLU ELEMANLAR ANALİZİ

Ahşabın mikro yapısı incelendiğinde hücre duvarlarının katmanlı olduğu görülür. Hücre duvarı selüloz, hemiselüloz ve lignin olarak üç organik bileşen içerir. Selüloz liflerinin hücre duvarındaki yerleşimi karmaşıktır ve ahşabın büyük anizotropisinin bir kısmını oluşturur. Hücreler ağaç türleri arasında hem şekilsel olarak hem de dizilim olarak farklılıklar göstermektedir. Ahşapta eksenel, radyal ve teğetsel olmak üzere üç simetri eksen tanımlanabilir. Üç simetri düzlemine atıfta bulunan karmaşık gerilim-gerinim ilişkileri mekanik özellikleri karakterize eder (Mackerle, 2005). Yani yönlere göre mekanik özellikler değişiklik gösterir. Mekanik yapıyı tam olarak tanımlamak için üç yönde de deneyler yapılmalıdır (Şirin ve Aydemir, 2016). Ahşabın anizotropik davranışı ve mikroyapı dağılımı dikkate alınarak son yıllarda makro mekanik davranış ve hücre dizisi deseni üzerine birçok çalışma yapılmıştır. Farklı yükleme yönlerinde ahşabın mekanik özellikleri, gerilme hızı, sıcaklık ve yoğunluğun etkisi geleneksel malzeme testi deneyleri ve SEM ile açıklanmıştır. Lignin, hemiselüloz ve kristalin amorf selüloz çekirdeği dahil olmak üzere nano ölçekli model simülasyonu, eşdeğer mekanik parametreleri analiz etmek için gerçekleştirilebilir. Simülasyon sonuçlarına dayanarak, yükleme yönelimi ve hızın ahşap mikroyapı hasar moduna etkisi belirlenebilir (Zhong vd., 2021).

Ahşap higroskopik bir malzemedir. SEM analizlerinde bir kurutma veya ıslatma prosesi simülasyonu ısı transferi, nemin hareketi ve mekanik deformasyon olarak üç temel olguyu içerir. Şişme ve büzülme (çalışma), bozulma ve şekil bozulmasının takip edilebileceği iç gerilimler oluşturur. Ahşap zamana bağlı deformasyonların yanı sıra ortotropik davranış da sergiler. Bu deformasyonlar genellikle viskoelastik



sünme (sabit nem içeriği) ve mekanik-emici sünme (değişen nem) olarak ikiye ayrılır (Mackerle, 2005). Simülasyonlar ahşap türü ve nemlenme nedenine göre oluşturularak kullanım yerindeki sonuçları görmeyi ya da tahmin etmeyi sağlamaktadır. Ayrıca simülasyonda sadece nem etkisi ile bozulma, tuzlu su, tatlı su ya da farklı su özellikleri, suyun mineral yapısı, sıcaklığı vs. ile ilgili etkiler yanında su ile oluşma ihtimali artan böcek ve mantar zararı da tahmin edilebilir. Bunlar gerçekte uzun sürede ölçülen sonuçlardır ancak bilgisayar ortamında sonuçlar çok hızlı alınabilir. Çürümeyi önlemek için ahşabın sürekli olarak kuru tutulması gerekir. Kurutma işleminin sonlu eleman simülasyonları, vakumla kurutma, yüksek sıcaklıkta kurutma, heterojen ahşap kurutma, kurutma sırasında ahşabın deformasyonu, kurutma sırasındaki gerilmeler ve gerinimler, nem değişimi altındaki ahşap, ahşabın değişken iklimlerdeki performansı, termal yangın direnci gibi çok farklı durumlar için rahatlıkla yapılmaktadır (Mackerle, 2005).

Ahşap herhangi bir nedenle deforme olabilir. Mesela mantarlar tarafından yapısında bulunan selüloz ve ligninin tüketilmesi ile çürüme meydana gelebilir. Selüloz ahşabın iskeletidir. Ligninse dayanıklılığı sağlar. Bu durum eksilen maddeye göre ahşapta farklı bir bozulmaya neden olmaktadır. Böcek zararları, insanların oluşturduğu zararlar, çeşitli hayvan zararları, yanma, ağacın kırılması, donması gibi ağaç ya da ahşap ürünlerde yaşanabilecek durumlar ve çözümleri üzerinde çalışılmaktadır. Ayrıca budaklar, lif kıvrıklığı, reaksiyon odunu gibi doğal kusurlar içeren durumlar da incelenmektedir. SEM analizlerinde odunun olumsuz özelliklerinin en aza indirilip olumlu özelliklerinin artırıldığı “odun modifikasyon çalışmaları” büyük önem taşımaktadır (Şirin ve Aydemir, 2016; Korkut vd., 2008).

Ahşap malzeme dendiğinde birçok ağaç türünden elde edilen çok farklı özellikte yapılar anlaşılır. Çok yumuşak ağaçlar, çok sert ağaçlar, doğal dayanımı yüksek ağaçlar, kolay ya da zor emprenye edilen ağaçlar, dekoratif özellikleri yüksek ağaçlar, akustik alanlarda değerli ağaçlar, kağıt üretiminde kullanılan ağaçlar gibi daha bir çok başlık altında sınıflandırmalar yapılabilir. Elbette bu zengin çeşitlilik türler arasında mikro yapıdaki farklılıklardan kaynaklanır. Ağaç türü yani malzeme özelliği doğru şekilde tanımlandığında aynı koşulların oluşturulduğu deneyler farklı çok sayıda malzeme için denenebilir. Herhangi bir kusurun da yine ağaç türüne, ahşap malzeme türüne, kullanım yerine göre nasıl oluşacağı ve ilerleyeceği modellenerek analiz edilebilmektedir.

Ahşap birleştirme ve sabitleme işlemlerinde birleşim yerlerindeki stres oluşumlarına dair SEM çalışmaları oldukça fazla görülmektedir. Kullanılan ahşap türü ve yapıştırma, vidalama, ahşabı ahşap ile birleştirme gibi işlemlerin birleşim yerlerinde oluşan yük etkilerine gösterilen tepkinin incelendiği çalışmalar SEM analizlerinin oldukça güvenilir sonuçlar verdiğini göstermiştir. Bu modeller ahşap kırılmasının temel mekanizmalarını yakalar ve ahşap deneylerinin yorumlanmasında faydalı olmaktadır (Nairn, 2006).

Odundan elde edilen orman ürünleri genel olarak kağıt, levha ve masif malzemeler şeklinde gruplandırılabilir. Bu gruplar kendi içinde masif mobilyalar, yapıştırılmış lamine malzemeler, kontrplak, yönlendirilmiş şerit levha, baskı kağıtları gibi birçok alt ürüne sahiptir (Mackerle, 2005). Ürün çeşitliliği oldukça fazla olan ahşap malzemelerde üretim yöntemleri de elbette farklıdır. Bu tür malzemelerin üretim sürecinde boşlukların ve doğal kusurların varlığı kaçınılmazdır (Fakoor ve Khezri, 2020). SEM analizlerinde bir ürünün üretiminde kusurlu ve sağlam malzeme kullanımının karşılaştırması aynı deney koşullarında tekrarlanabilir. Kusurlu bölümlerdeki mekanik tepkiler, bu kısımların ahşap malzemedeki etki alanları, etki dağılımı ve etki miktarı belirlenebilmektedir. Birçok araştırmacı, ahşap ve ahşap hibrit yapıların incelemelerine ilişkin deneysel, analitik ve sayısal olarak çalışmalar yayınlamıştır. Ahşabın doğru kullanımını anlamak çeşitli yüklem türleri için ayrıntılı mekanik özelliklerin belirlenmesi ile mümkündür (Fajdiga vd., 2019). Simülasyonlar, ahşap mekaniğinin birçok özelliğini yeniden üreterek ahşap anatomisinin mekanik davranışlar üzerindeki etkileri hakkında fikir vermektedir ve gerçekçi ahşap yapıların genişletilmiş, kapsamlı sayısal hesaplamalarını yapabilmektedir (Nairn, 2006).



Ahşap işlemede sonlu eleman simülasyonları, talaş oluşumu, kesme kuvvetinin belirlenmesi, kesme sırasında ahşap hücrenin çökmesi, kesme sonrası artık gerilmeler, ahşap yüzeylere yapılan işlemler, daire testerelerin modellenmesi, testere bıçağı titreşimleri, sertliği arttırmak için reçine kullanılması, dalga yayılımı, ahşap koruma işlemleri gibi çalışmalarda da kullanılmaktadır (Mackerle, 2005). Ahşap işleme araçları ve ahşap işlemleri hem ağaç türüne hem de kullanılan malzemelere göre yine çok çeşitlidir. Bu büyük ürün ve işlem çeşitliliği içerisinde simülasyonlara olan güvenin artması ile endüstriyel anlamda modellemeye olan ilgi de oldukça fazladır.

## SONUÇLAR

Karmaşık malzemelerin özelliklerinin analizi oldukça zordur. Kesin çözümlerin elde edilemediği birçok pratik mühendislik problemi vardır. Bu tür durumlarda karar verme süreci çok zaman alır ve her zaman en uygun çözümün seçilmesiyle sonuçlanmaz. Bu tür problemlerle başa çıkmak için sayısal yaklaşımlara başvurulmaktadır (Tankut vd., 2014). Mühendislik uygulamalarında problemlerin karmaşıklığı sebebiyle genellikle problemlerin tam çözümü yerine, kabul edilebilir seviyede bir yaklaşık çözüm tercih edilir. Ancak bu çözümün iyileştirilmesi ve kesin sonuca çok yaklaşılması hatta kesin sonuca ulaşılması mümkündür (Şirin ve Aydemir, 2016). En etkili üretim metodunu seçmek, malzeme türü, üretim yöntemi, herhangi bir kusurla karşılaşma durumları için farklı senaryolar denemek ve sonuçları kısa sürede almak simülasyonlarla oldukça kolaydır.

Hesaplama tekniğinin gelişmesiyle birlikte sayısal simülasyon, ahşabın mekanik özelliklerinin araştırılmasında ekonomik ve etkili bir yöntem haline gelmiştir (Zhong vd., 2021). Ahşap bazen pahalıdır ve her ne kadar yenilenebilir bir kaynak olsa da tükenmez değildir. Laboratuvar ortamında küçük parçalarla deneyler yapılır ancak gerçek materyaller çok daha büyük boyutlu olabilir. Sayısal analizlerle malzeme henüz kullanılmadan ya da bazı durumlarda henüz üretimi yapılmadan ne gibi sonuçlarla karşılaşılacağı hakkında bir ön bilgi oluşmaktadır. Çalışmalarda, heterojen yapısı sebebiyle fazla örnek kullanımı gerektiren ahşap malzemede önemli bir maliyet ve malzeme kazancı mümkündür. Analistler, SEM aracılığı ile ahşap bileşenlere uygulanabilecek geniş bir modelleme yelpazesine sahiptir. En önemli faktör, her bir modelleme konseptinin yeteneklerinin bilinmesi ve eldeki probleme uygun seçimin yapılmasıdır.

Bilgisayarların kalitesinin ve güvenilirliğinin sürekli olarak iyileştirilmesi ve bunların endüstriyel tasarımlarda yaygın olarak kullanılması SEM'in ahşap mekaniğinde kullanımına ilgiyi de artırmıştır. Modern mühendislik çalışmalarında amaç, modellerin test verileri aralığının ötesinde tahminler yapmak için kullanılabilmesidir (Tankut vd., 2014). SEM yaklaşımı ve bu yaklaşımdaki gelişmeler, hesaplama çabası ve algoritmik uygulama açısından son derece kapsamlıdır. Bu durum şaşırtıcı değildir çünkü bu yöntem en geniş tanımlama esnekliğine sahiptir ve dolayısıyla doğadaki süreçleri en gerçekçi şekilde yeniden üretme potansiyeli vardır. Genişletilmiş sonlu elemanlar yöntemiyle malzemelerin ve kullanım sırasında olabileceklerin modellenmesi karmaşık geometrilere ve yüklemeye koşullarına sahip problemlere uygulanabilmektedir.

SEM ahşabın mekanik davranışı hakkında bilgi edinmek ve ahşapla ilgili diğer modeller için referans olarak hizmet etmek için bir araç olarak çok büyük değere sahiptir (Füssl vd., 2017).

## Kaynaklar

- Fajdiga G, Rajh D, Nečemer B, Glodež S, Šraml M, 2019. Experimental and numerical determination of the mechanical properties of spruce wood. *Forests*, 10(12), 1140. DOI: 10.3390/f10121140
- Fakoor M, Khezri MS, 2020. A micromechanical approach for mixed mode I/II failure assessment of cracked highly orthotropic materials such as wood. *Theoretical and Applied Fracture Mechanics*, 109, 102740. DOI: 10.1016/j.tafmec.2020.102740
- Fu Y, Fang H, Dai F, 2017. Study on the properties of the recombinant bamboo by finite element method. *Composites Part B: Engineering*, 115, 151-159. DOI: 10.1016/j.compositesb.2016.10.022

- Füssl J, Li M, Lukacevic M, Eberhardsteiner J, Martin CM, 2017. Comparison of unit cell-based computational methods for predicting the strength of wood. *Engineering Structures*, 141, 427-443. DOI: 10.1016/j.engstruct.2017.03.005
- Güntekin E, Yılmaz T, 2013. Eğilmeye çalışan budaklı kirişlerin sonlu elemanlar modelleri. *SDÜ Orman Fakültesi Dergisi*, 14, 53-7.
- Gürer C, Akbulut H, Cetin S, 2008. Tek açıklıklı kemer sistemli rize köprülerinin sonlu elemanlar yöntemi ile analizi. 1. Köprü ve Viyadükler Sempozyumu. 26-28 Kasım 2008, ss. 435-445. Antalya.
- Huber JA, Broman O, Ekevad M, Oja J, Hansson L, 2022. A method for generating finite element models of wood boards from X-ray computed tomography scans. *Computers and Structures*, 260, 106702. DOI: 10.1016/j.compstruc.2021.106702
- Korkut S, Korkut DS, Bekar İ, 2008. Okalıptüs (*Eucalyptus camaldulensis* Dehn.) odununun bazı teknolojik özellikleri üzerine ısı işlemin etkisi. I. Ulusal Okalıptüs Sempozyumu, 15-17 Nisan 2008, Tarsus, Türkiye.
- Mackerle J, 2005. Finite element analyses in wood research: A bibliography. *Wood science and technology*, 39, 579-600. DOI: 10.1007/s00226-005-0026-9
- Nairn JA, 2006. Numerical simulations of transverse compression and densification in wood. *Wood and Fiber Science*, 576-591.
- Ormarsson S, Dahlblom O, Johansson M, 2009. Finite element study of growth stress formation in wood and related distortion of sawn timber. *Wood Science and Technology*, 43, 387-403. DOI: 10.1007/s00226-008-0209-2
- Şirin G, Aydemir D, 2016. Sonlu elemanlar metodunun ahşap malzemelerde kullanımına ilişkin bir araştırma. *Bartın Orman Fakültesi Dergisi*, 18(2), 205-212. DOI: 10.27011/barofd.272971
- Tankut N, Tankut AN, Zor M, 2014. Finite element analysis of wood materials. *Drvna industrija*, 65(2), 159-171. DOI: 10.5552/drind.2014.1254
- Vasic S, Smith I, Landis E, 2005. Finite element techniques and models for wood fracture mechanics. *Wood science and technology*, 39, 3-17. DOI: 10.1007/s00226-004-0255-3
- Zhong W, Zhang Z, Chen X, Wei Q, Chen G, Huang X, 2021. Multi-scale finite element simulation on large deformation behavior of wood under axial and transverse compression conditions. *Acta Mechanica Sinica*, 37, 1136-1151. DOI: 10.1007/s10409-021-01112-z

#### Çıkar Çatışması

Yazarlar çıkar çatışması olmadığını beyan etmişlerdir.

#### Yazar Katkıları

Göksu Şirin: Araştırma, çalışmanın yazılması.

## Managing the Replication Crisis: Difficulties and Prospects in Psychology with an Emphasis on Statistics

Mehmet Siddık Çadırıcı<sup>1\*</sup>

<sup>1</sup>Cumhuriyet University, Faculty of Science, Department of Statistics and Computer, 58140, Sivas, Türkiye

\*Corresponding author e-mail: msiddikcadirci@cumhuriyet.edu.tr

### Abstract

*The integrity of study findings is seriously threatened by the replication dilemma, which is especially common in psychology. Statistics play a crucial role in this. This presentation highlights the crucial role statistics play in addressing replication problems as it examines the many opportunities and challenges found in psychology. The prominence of psychology in the replication debate stems from the abundance of research outputs, which is made worse by publication pressure that frequently emphasises quantity before statistical rigour. As a result, statistical methods are scrutinised because the crisis emphasises how important it is to provide excellent, repeatable study results. The Open Science movement, which promotes openness and cooperation in statistical procedures, is one effort aimed at resolving the replication dilemma. Effectiveness sizes, confidence intervals, and replication rates should be the primary focus of a critical reassessment of conventional statistical techniques, rather than only statistical significance. Challenges to the reliability of earlier statistical analyses and their influence on policy choices are among the consequences of the replication dilemma that go beyond academics. To overcome ethical and practical conundrums, this complexity calls for interdisciplinary cooperation. In conclusion, statistics has both opportunities and challenges because of the psychology replication issue. Psychology may improve its research methods and make a significant contribution to the larger scientific community by emphasising openness, rigour, and cooperation in statistical techniques.*

**Keywords:** Replication crisis, Statistics, Reproducibility, Psychology, Open Science.

### INTRODUCTION

The idea of replication is fundamental to scientific inquiry in psychology research and is necessary to confirm the validity and robustness of empirical findings. The practice of reproducing a study with the same methods in order to see whether the initial findings can be repeated under uniform circumstances is known as replication. This procedure is critical for verifying the accuracy of research findings as well as for laying the groundwork for trustworthy scientific information that will be needed for future theoretical advancement and real-world application.

But the psychology community is currently enduring a replication crisis, characterised by a high percentage of research that falter when their findings are tried to be replicated. This situation poses a serious danger to psychology's very scientific credibility in addition to being a methodological issue. This problem has broad ramifications for psychological science theory, practice, and policymaking, among other areas.

### The Replication Crisis: An Overview

The replication crisis is a term used to describe the increasing recognition in the scientific community and the psychology community that many experimental outcomes are not as repeatable as previously thought. A number of well-publicized replication failures gave rise to this crisis and generated much discussion over the validity of psychological research. The significance of addressing these challenges



has been highlighted by initiatives such as the Reproducibility Project, which in 2015 reported a replication success rate of only approximately 36% for important studies published in leading psychology publications.

The crisis's historical background stems from growing apprehensions over the last few decades regarding the reliability of research findings that have been published. Systemic flaws in the research process, such as p-hacking, selective reporting, and the publishing bias favouring fresh, positive results over negative or null data, have contributed to these worries. These kinds of actions undermine the validity of research and make it more challenging to replicate findings.

The seriousness of the situation has been further underscored by eminent research that look at replication rates. For instance, the previously stated Reproducibility Project discovered significant discrepancies in effect sizes between the original research and its replications, indicating that a number of the initial findings may have been inflated or incorrect as a result of methodological problems or statistical errors. The need for methodological rigour and transparency in psychological research has been brought up in a big way as a result of this revelation, with many calling for reforms that would improve statistical procedures, strengthen experimental designs, and increase transparency throughout the study process.

### Literature Review

The reproducibility and dependability of study findings are called into doubt by the replication problem, which is a critical concern facing psychology. Numerous studies that evaluate the frequency of replication attempts and their results have brought attention to this situation, exposing structural problems that compromise the objectivity of psychological research (Caruso *et al.*, 2013).

Makel, Plucker, and Hegarty's study reveals the dearth of replication in psychological research by examining the publication policies of the top 100 psychology journals between 1900 and 2012. According to their findings, just 1.6% of publications made a clear attempt at replication. The replication rate was adjusted to a somewhat higher but still alarming 1.07% when a more thorough review of a selection of 500 research showed that an apparent 68% of articles that did not use the phrase "replication" were actually replication attempts (Makel, Plucker and Hegarty, 2012).

This low frequency of replication attempts is exacerbated by a societal predisposition towards fresh discoveries, as one study that examined articles from four prestigious social science journals from 1980 to 1988 showed. Just 25% of the publications concentrated on replication, while over 75% of them highlighted fresh findings. According to this study, the equally important scientific practice of replication is sometimes overlooked in favour of unique findings, which are thought to be more likely to result in publication and grant money (Caruso *et al.*, 2013; Aarts *et al.*, 2015). This inclination was also reflected in the discussion published in these publications, where more than half of the commentators preferred new findings to replications. This further discouraged replication attempts and added to the low rates seen in the field.

A more modern viewpoint comes from the Open Science Collaboration's (OSC) initiative from 2015, which showed that just 36% of the duplicated experiments yielded significant findings a sharp contrast to the original studies' 97% significance rate. This stark discrepancy draws attention to the possibility of overestimation of impact sizes in the original research as well as the variation in replication performance in other psychological domains. For example, compared to social psychology, cognitive psychology showed better replication success, with rates of 23%, 38%, and 38% for prestigious journals such as the Journal of Personality and Social Psychology, Journal of Experimental Psychology: Learning, Memory, and Cognition, and Psychological Science, respectively (Aarts *et al.*, 2015).

Replication success was significantly increased when original authors participated in the process, according to the OSC study. This finding suggests that having close understanding of the study's design

and execution can boost reproducibility (Coyne, 2016). This result emphasises how crucial it is for independent replication teams to work with original researchers to guarantee the validity and dependability of psychological research.

The body of research clearly shows how urgently psychology has to undergo a culture revolution that values and prioritises replication. The field can effectively solve the replication dilemma by promoting collaborative research processes, raising incentives for replication studies, and improving methodological transparency. Such endeavours are essential for the advancement of scientific understanding as well as for guaranteeing the continued strength, dependability, and significance of psychological research as a field (Lindsay, 2015).

## FINDINGS AND DISCUSSION

It is vital and appropriate to have a conversation on the validity of research findings, particularly in domains where studies are small-scale and design factors are extremely variable. The scientific community has a systemic problem where the pursuit of statistical significance frequently takes precedence above the research's practical usefulness and reproducibility, as demonstrated by Ioannidis's ground-breaking claim that many scientific discoveries are fundamentally incorrect (Ioannidis, 2018).

This story critically looks at how the integrity of scientific research is put to the test by the false discovery rate (FDR), which is the likelihood that a statistically significant finding does not represent a true effect. The positive predictive value (PPV), which calculates the likelihood that a significant result is true, is balanced by the false negative rate (FNR). Elevated false discovery rates indicate a high frequency of false positives, which mostly occur when study factors like effect magnitude, sample size, and methodological flexibility are not closely monitored.

Statistical significance, which is commonly set at  $p < 0.05$ , necessitates a careful analysis, especially in view of Ioannidis's findings. Insufficient study power can lead to misleading results even if the results meet this requirement. In line with best practices with statistical testing, a power parameter of 0.8 is typically advised to guarantee that a genuine effect is detected 80% of the time (Bennett and Miller, 2010; Lehmann and Romano, 2022). Thus, sufficiently powered tests are essential to the trustworthiness of statistical results because they increase the probability of discovering actual effects and reduce the possibility of false positives.

The problem touches on the ethical ramifications of research and goes beyond statistical measures. In addition to increasing the rate of false positives, small sample numbers, adaptable study designs, and hidden biases all undermine the reliability of inferences made from the data. Such actions can result in the implementation of detrimental or inefficient policies, underscoring the need for strict methodological guidelines and open reporting in research (Darley and Gross, 1983).

In order to address these issues, scientists are advised to employ tactics that boost their studies' statistical power, which lowers the FDR and improves the validity of their conclusions. This calls for careful planning in order to minimise biases and guarantee appropriate sample sizes—steps that are critical to preserving the validity of scientific research (Bem, 2011).

In the end, scientific research integrity rests on a foundation of trust: the belief that results are both statistically significant and accurately representative of reality. For knowledge to advance and good policy to be informed, it is essential to ensure the trustworthiness of research through improved statistical techniques and a commitment to transparency.

### **The rate of false discovery in significance testing**

It becomes clear that conventional hypothesis testing may not be as reliable as previously believed when considering the validity of statistical testing, especially in situations where the null hypothesis is true. Imagine that 900 tests are performed with no discernible impact; in this case, the null hypothesis is correct. As indicated in Figure 25, conventional expectations state that roughly 5% of these tests, or 45

tests, will produce false positive results. This case highlights serious doubts about the validity of hypothesis testing, especially with regard to the potentially misleading assumption that a 5% false discovery rate (FDR) indicates a small percentage of findings.

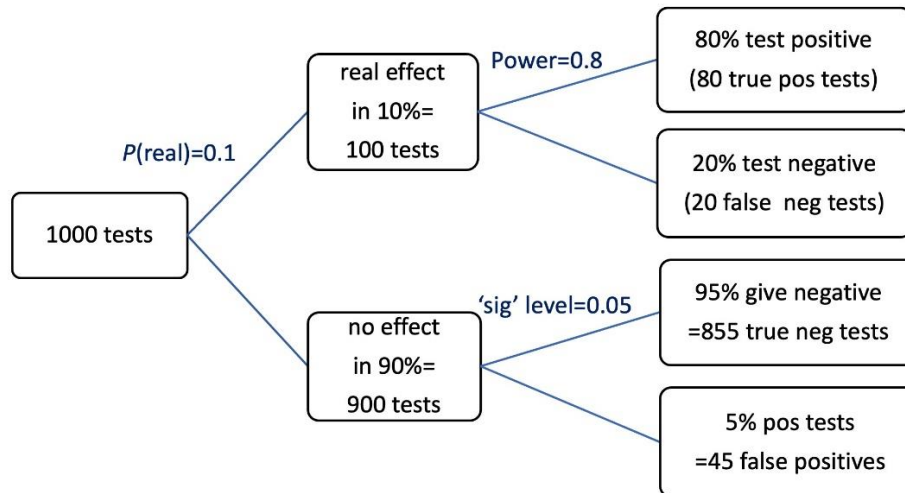


Figure 25. An example of false discovery rates that illustrates how expected and observed results in hypothesis testing differ.

A more thorough examination of the FDR and its consequences for research conclusions is therefore required because this crude computation does not take into consideration the overall number of positive tests or go into the particulars of each test result (Benjamini and Hochberg, 1995). The complexity of this problem is further demonstrated by Figure 25, which shows the distribution of results across 1000 tests where the expected number of false positives is not as expected as is commonly believed.

Crucially, the computation indicates that the real FDR, or 45/ (45+80), is roughly 36%. This rate challenges the validity of many published findings and highlights the need for researchers to closely assess the relevance of their findings because it is significantly greater than the generally accepted 5%. The differences indicated in Figure 25 highlight how crucial it is to discern between statistical abnormalities that could lead to false conclusions and true significance.

The scientific community must reevaluate the procedures used in statistical testing in order to allay these worries, placing special emphasis on the requirement for strict controls and a more precise interpretation of p-values. By taking these steps, research findings will be more reliable and genuine discoveries will be acknowledged and verified by rigorous scientific examination.

### 1. In cases where the null hypothesis is true

The simulation of 100,000 t-tests can help clarify the implications of hypothesis testing in the case that the null hypothesis is correct. Figure 26 illustrates the results of this simulation, which show what happens when there is actually no difference between the two groups being studied. The tests are made such that the true means for the treatment and control groups are the same, guaranteeing that any differences found are the result of chance rather than real effects.



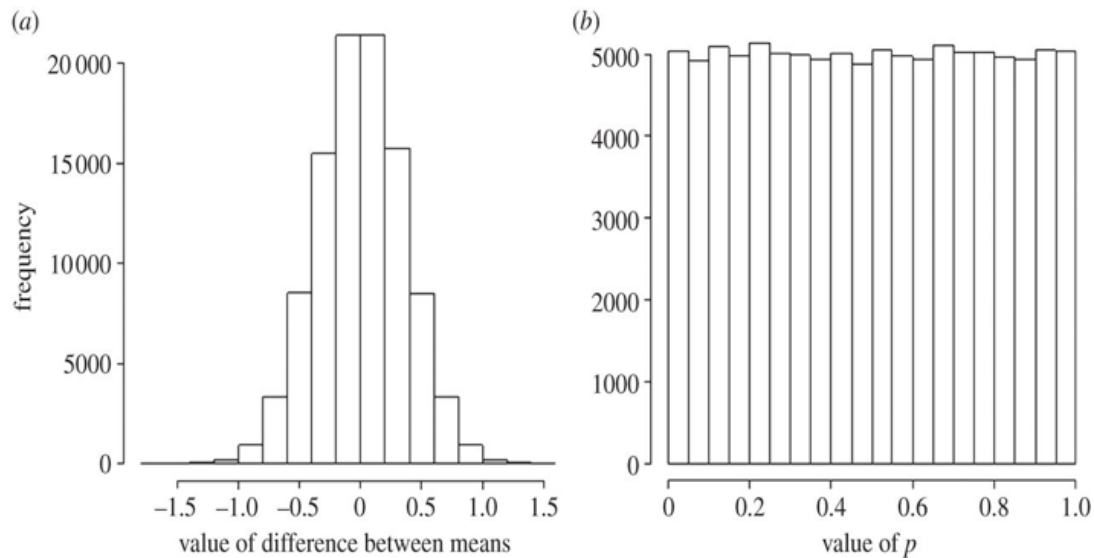


Figure 26. The result of 100,000 simulated t-test with a true null hypothesis applied, showing the false positive rate and p-value distribution.

The distribution of the 100,000 observed variations in means in these simulations is centred around zero, suggesting that, on average, the means are equal as predicted by the null hypothesis. The image illustrates the intrinsic variability in the data with a standard deviation of 0.354. Notably, Figure 26 b) displays a uniform p-value distribution, indicating that, in the event that the null hypothesis is true, every p-value ranging from 0 to 1 has an equal probability.

5% of these tests (or 5000 tests) provide p-values that are less than or equal to 0.05, indicating false positives. Each p-value is equally likely, indicating that the p-values are not replicable under current circumstances, as indicated by their flat distribution. This uniform distribution makes it clear that p-values do not show the existence of an effect under the null hypothesis, which emphasises the need to interpret statistically significant data carefully.

This analysis emphasises how important it is for researchers to take into account the potential for false positives and the actual consequences of their findings, especially when substantial results are presented in circumstances that could really support the null hypothesis. These simulations provide important insights into the limitations of p-values as an effect metric and highlight the significance of statistical power and appropriate test calibration in research.

## 2. In cases where the null hypothesis is not true

The consequences change dramatically when one examines the results of hypothesis testing in cases when the null hypothesis is not true. As shown in Figure 27, consider the simulation of 100,000 t-tests, which is intended to investigate situations in which the null hypothesis is not true. In this configuration, a mean difference of 1 between two groups represents the expected genuine impact size, and a standard deviation of 0.354 affects the results for each group.

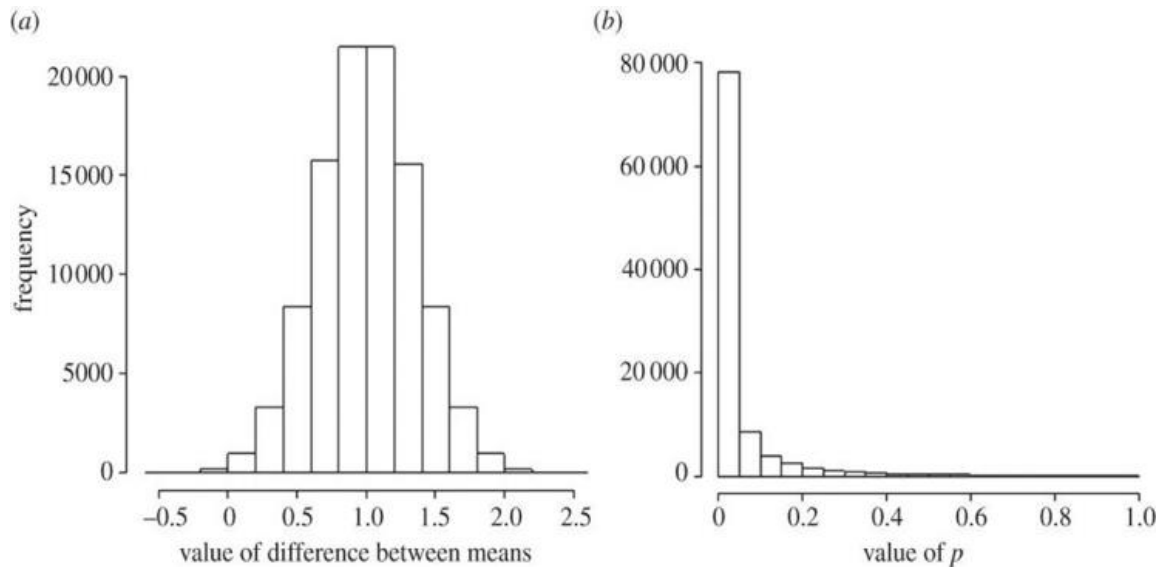


Figure 27. Outcomes of 100,000 simulated t-tests with p-values and distributions of observed differences when the null hypothesis is false.

The essential insights revealed by the simulation findings are illustrated in Figure 27:

- The observed values for the method contrasts show a standard deviation that is consistent with the true difference that is hypothesised, highlighting the t-test's efficacy in identifying real effects when they are present.
- These tests' p-value distribution demonstrates a notable clustering around lower values, well below the usual  $p=0.05$  threshold, which is consistent with a real effect being present.

These results show that statistical tests are powerful enough to identify real effects even in cases where the null hypothesis is mistakenly taken to be true. The main difficulty, though, is accurately interpreting this data without overestimating the effects' presence because of bias in the study design or random variation. The dependability of the results is further supported by the test's power and sample size, which are calibrated to detect a true effect 80% of the time.

This simulation emphasises the need for meticulous test parameter selection and rigorous study design in order to guarantee correct statistical significance interpretations. It also draws attention to the possible drawbacks of drawing conclusions about scientific facts only from p-values, arguing instead for a more nuanced strategy that takes effect sizes and confidence intervals into account to paint a more complete picture of the research findings.

## CONCLUSION

This study draws attention to a crucial problem in scientific research: just around 30% of reported results show significant impacts, casting doubt on the veracity of many scientific assertions. One reason for the high rate of non-reproducible outcomes is the widespread habit of prioritising unique findings over thorough, repeatable research. The misconception of statistical significance and the drive to publish frequently persist in biasing the scientific literature towards seemingly positive findings, even in the face of publication practices that do not distinguish between positive and negative outcomes. The scientific community should reconsider how research integrity is upheld and conclusions are communicated in light of this deception.

In order to overcome these obstacles, we must push for a change in emphasis from the originality of findings to the replication and openness of research. Important steps towards achieving this goal include strengthening peer review procedures to carefully examine the robustness of study designs and making

sure statistical significance is correctly interpreted. The scientific community can greatly increase the credibility and dependability of published research by promoting an atmosphere that prioritises careful validation of research findings. This will promote wise policy decisions and the advancement of science.

## REFERENCES

- Aarts, A. A. *et al.* (2015) 'Estimating the reproducibility of psychological science', *Science*, 349(6251). doi: 10.1126/science.aac4716.
- Bem, D. J. (2011) 'Feeling the Future: Experimental Evidence for Anomalous Retroactive Influences on Cognition and Affect', *Journal of Personality and Social Psychology*, 100(3), pp. 407–425. doi: 10.1037/a0021524.
- Benjamini, Y. and Hochberg, Y. (1995) 'Controlling the False Discovery Rate: A Practical and Powerful Approach to Multiple Testing', *Journal of the Royal Statistical Society: Series B (Methodological)*, 57(1), pp. 289–300. doi: 10.1111/j.2517-6161.1995.tb02031.x.
- Bennett, C. M. and Miller, M. B. (2010) 'How reliable are the results from functional magnetic resonance imaging?', *Annals of the New York Academy of Sciences*, 1191, pp. 133–155. doi: 10.1111/j.1749-6632.2010.05446.x.
- Caruso, E. M. *et al.* (2013) 'Mere exposure to money increases endorsement of free-market systems and social inequality', *Journal of Experimental Psychology: General*, 142(2), pp. 301–306. doi: 10.1037/a0029288.
- Coyne, J. C. (2016) 'Replication initiatives will not salvage the trustworthiness of psychology', *BMC Psychology*. *BMC Psychology*, 4(1), pp. 1–11. doi: 10.1186/s40359-016-0134-3.
- Darley, J. M. and Gross, P. H. (1983) 'A hypothesis-confirming bias in labeling effects', *Journal of Personality and Social Psychology*, 44(1), pp. 20–33. doi: 10.1037/0022-3514.44.1.20.
- Ioannidis, J. P. A. (2018) 'Why most published research findings are false', *Getting to Good: Research Integrity in the Biomedical Sciences*, 2(8), pp. 2–8. doi: 10.1371/journal.pmed.0020124.
- Lehmann, E. L. and Romano, J. P. (2022) *Testing Statistical Hypotheses Fourth Edition*. Available at: <https://link.springer.com/bookseries/417>.
- Lindsay, D. S. (2015) 'Replication in Psychological Science', *Psychological Science*, 26(12), pp. 1827–1832. doi: 10.1177/0956797615616374.
- Makel, M. C., Plucker, J. A. and Hegarty, B. (2012) 'Replications in Psychology Research: How Often Do They Really Occur?', *Perspectives on Psychological Science*, 7(6), pp. 537–542. doi: 10.1177/1745691612460688.



## Transmuted Epanechnikov Exponential Distribution

Tenzile ERBAYRAM<sup>1\*</sup>, Yunus AKDOĞAN<sup>1</sup>

<sup>1</sup>Department of Statistics, Faculty of Science, Selcuk University, 42250, Konya, Türkiye

\*Corresponding author e-mail: tenzile.erbayram@selcuk.edu.tr

### Abstract

*This article introduces a new lifetime distribution called the transformed Epanechnikov exponential distribution. This is a generalization of the Epanechnikov exponential distribution based on the quadratic order transformation map. Different properties of the obtained distribution have been investigated. Statistical inferences for the parameters of the proposed distribution were examined with six estimation methods, such as maximum likelihood, moments, least squares, weighted least squares, Cramer-Von Mises, and Anderson-Darling. A Monte Carlo simulation study was conducted to evaluate these estimators based on the mean square error estimation, mean absolute deviation, and mean relative errors of estimation for different-size samples. Additionally, application to three real-life data sets is presented to demonstrate the usefulness of the proposed distribution. As a result of this application, it has been shown that the new model is more adequate than the Epanechnikov exponential and some other existing exponential distributions.*

**Keywords:** Transmuted Distribution, Epanechnikov Exponential, Estimation, Monte Carlo Simulation.

### INTRODUCTION

Probability distributions are widely employed across various areas of life. The quality of procedures used in statistical analysis is largely dependent on the assumed probability model or distributions. Therefore, significant efforts have been dedicated to developing wide classes of standard probability distributions along with relevant statistical methodologies. As a result, numerous probability distributions have been developed by researchers. The statistical literature is replete with hundreds of continuous univariate distributions. However, in recent years, practical problems have arisen in applications within environmental, financial, biomedical sciences, and engineering fields where datasets deviate from the standard probability distributions. Hence, there is a clear need for the extended forms of classical distributions. In this context, substantial progress has been made in generalizing some well-known distributions and successfully applying these generalizations to problems in various fields such as engineering, finance, economics, and biomedical sciences.

Shaw and Buckley (Shaw and Buckley, 2009) introduced an interesting method of adding new parameters to an existing distribution to solve problems related to financial mathematics. They called this method the Family of Quadratic Transformed Distributions (QRTM). Transformed distributions can be obtained by adding a real number  $\lambda$  ( $|\lambda| \leq 1$ ) to the cumulative distribution function (cdf). Hence, if any random variable  $X$  has a cdf  $G(x)$ , then the cdf of the family has the following simple quadratic form.

$$F(x) = (1 + \lambda)G(x) - \lambda[G(x)]^2, \quad |\lambda| \leq 1 \quad (1)$$

$F(x)$  is called the distribution function of the transmuted distribution. The probability density function (pdf) of the transformed distribution is given by:

$$f(x) = [(1 + \lambda) - 2\lambda G(x)]g(x), \quad (2)$$

where  $g(x)$  is the pdf of the underlying distribution.

Recently many transformed distributions have been proposed. Aryal and Tsokos (Aryal and Tsokos, 2011) presented a new generalization of the Weibull distribution called the transformed Weibull distribution. Merovci (Merovci, 2013) proposed and studied several structural features of the transformed Rayleigh distribution. Khan and King (Khan and King, 2013) introduced the transmuted modified Weibull distribution. The transformed Lomax distribution is presented by Ashour and Eltehiwy (Ashour and Eltehiwy, 2013a). Elbatal et al. (Elbatal et al., 2013) transformed generalized linear exponential distribution is offered. Merovci and Puka (Merovci and Puka, 2014) introduced the transformed Pareto distribution. Ashour and Eltehiwy (Ashour and Eltehiwy, 2013b) proposed the transformed exponentialized modified Weibull distribution. The various distributional properties of the transformed exponentiated Gamma distribution by Hussian (Hussian, 2014) transformed exponentiated Gamma distribution. Oguntunde and Adejumo (Oguntunde and Adejumo, 2015) introduced the transformed inverse exponential distribution. The transformed Gompertz distribution is presented by Abdul-Moniem and Seham (Abdul-Moniem and Seham, 2015).

Alkhazaal and Al-Zoubi (Alkhazaal and AL-Zoubi, 2021) proposed the Epanechnikov exponential distribution (EED). This distribution is a combination of the Epanechnikov kernel function and the exponential distribution. The cdf of EED is defined as:

$$F(x) = 1 - \frac{3}{2}e^{-2\theta x} + \frac{1}{2}e^{-3\theta x} \quad (3)$$

The pdf of the EED is defined as:

$$f(x) = \frac{3\theta}{2}(2e^{-2\theta x} - e^{-3\theta x}), \quad x > 0, \theta > 0. \quad (4)$$

The remainder of the the article is organized as follows. We give a detailed introduction of the transformed Epanechnikov-exponential distribution in Chapter 2. In Chapter 3, we discussed the parameter estimators used for the new model, which includes various statistical methods such as the maximum likelihood method, moment method, least squares method, and weight least squares method, Cramer-Von Mises method, Anderson Darling method. We use three real data sets to show that the transformed Epanechnikov-exponential distribution may be a better model than the exponential distribution and its different transformations in Chapter 4. Chapter 5 concludes the paper by summarizing the paper and highlighting the results obtained.

## TRANSMUTED EPANECHNIKOV EXPONENTIAL DISTRIBUTION

In this section, we propose the transmuted Epanechnikov exponential (TEpED) distribution. The cdf of the proposed distribution is obtained by substituting the expression in Equation 3 for Equation 1. Therefore, if the cdf is expressed as below, it is stated that the random variable X follows the TEpED distribution

$$F_{TEpED}(x) = 1 - \frac{1}{4} \left( (2 - 2\lambda)(3e^{-2\theta x} - e^{-3\theta x}) + \lambda(3e^{-2\theta x} - e^{-3\theta x})^2 \right)$$

The corresponding pdf is expressed as follows:

$$f_{TEpED}(x) = \frac{3}{2}\theta(e^{-3\theta x} - 2e^{-2\theta x})(\lambda e^{-3\theta x} - 3\lambda e^{-2\theta x} + \lambda - 1)$$

The survival function is expressed as follows:

$$S_{TEpED}(x) = \frac{1}{4} \left( (2 - 2\lambda)(3e^{-2\theta x} - e^{-3\theta x}) + \lambda(3e^{-2\theta x} - e^{-3\theta x})^2 \right)$$

The hazard rate function is defined as follows:

$$h_{TEpED}(x) = \frac{6\theta(e^{-3\theta x} - 2e^{-2\theta x})(\lambda e^{-3\theta x} - 3\lambda e^{-2\theta x} + \lambda - 1)}{((2 - 2\lambda)(3e^{-2\theta x} - e^{-3\theta x}) + \lambda(3e^{-2\theta x} - e^{-3\theta x})^2)}$$

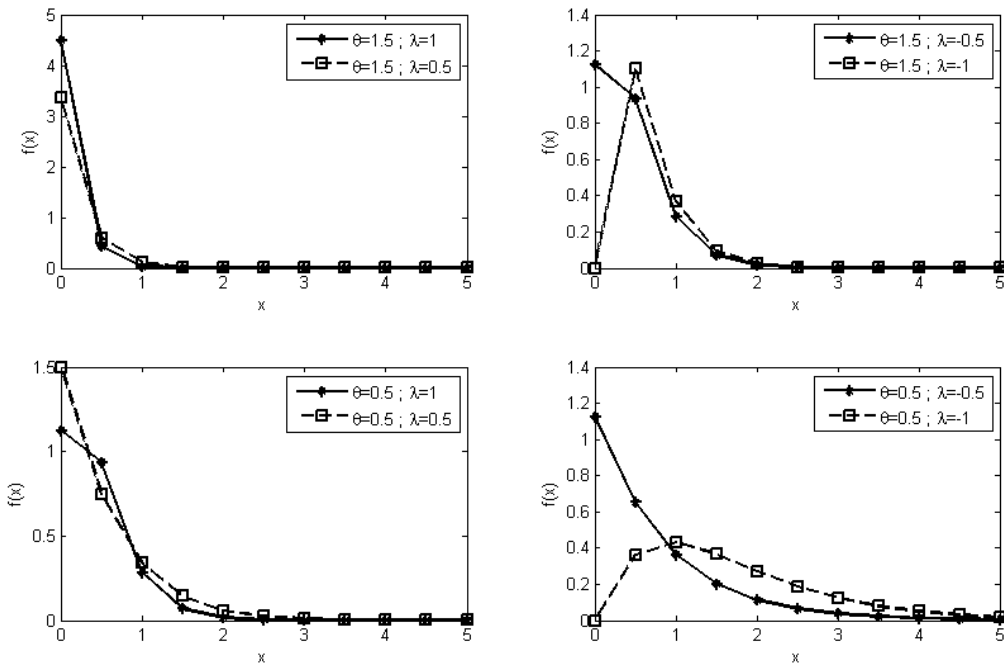


Figure 1. The pdf of TEpED distribution for some choices of  $\theta$  and  $\lambda$ .

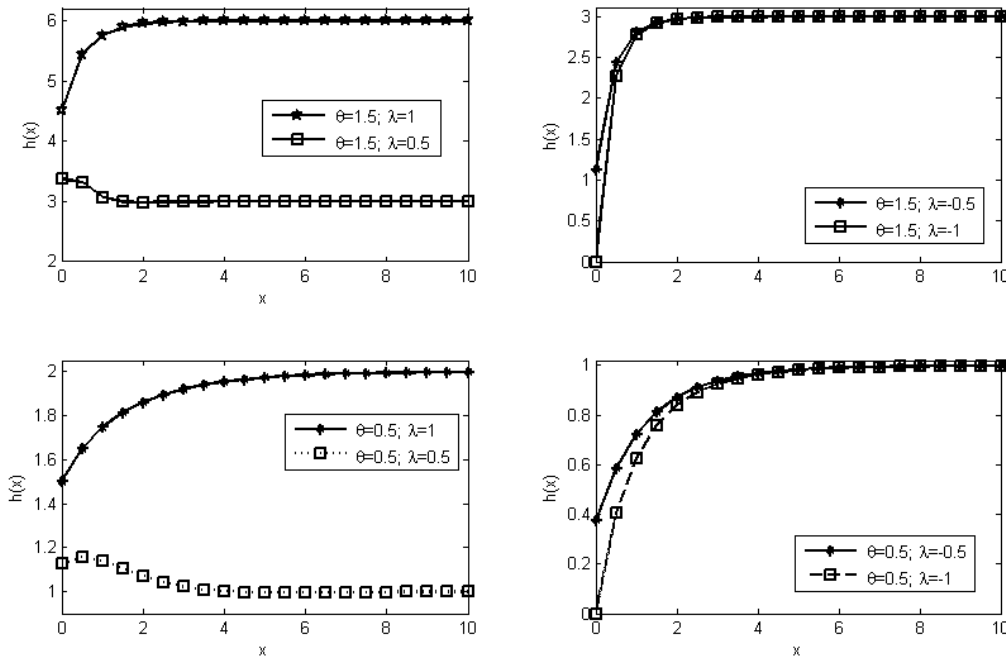


Figure 2. The h of TEpED distribution for some choices of  $\theta$  and  $\lambda$ .

### Distributional Properties



The first four moments of the TEpED distribution are respectively presented as follows:

$$E(X) = \frac{140 - 67\lambda}{240\theta},$$

$$E(X^2) = \frac{4600 - 3339\lambda}{7200\theta^2},$$

$$E(X^3) = \frac{146000 - 124993\lambda}{144000\theta^3},$$

$$E(X^4) = \frac{4540000 - 4198791\lambda}{2160000\theta^4}.$$

The variance, distribution index (DI), skewness, and kurtosis of the TEpED distribution is obtained as follows:

$$Var(X) = \frac{7200 - 7952\lambda - 4489\lambda^2}{57600\theta^2}$$

$$DI = \frac{Var(X)}{E(X)} = \frac{4489\lambda^2 + 7952\lambda - 17200}{240\theta(67\lambda - 140)}$$

$$\gamma_1 = \frac{E(X - E(X))^3}{[Var(X)]^{\frac{3}{2}}}$$

and

$$\gamma_2 = \frac{E(X - E(X))^4}{[Var(X)]^2}.$$

**Table 1:** Expected value, variance, kurtosis, and skewness for some choices of parameters.

$\lambda$	$\theta$	$E(X)$	$Var(X)$	Kurtosis	Skewness	DI
0.5	0.5	0.8875	0.8404	168.6080	-8.1960	0.9469
0.5	1.5	0.2958	0.0934	2.0816	2.4921	0.3156
1.0	0.5	0.6083	0.3305	121.9266	-2.6979	0.5433
1.0	1.5	0.2028	0.0367	1.5053	4.7758	0.1811
-0.5	0.5	1.4458	1.3926	105.3392	-19.8451	0.9632
-0.5	1.5	0.4819	0.1547	1.3005	0.5359	0.3211
-1.0	0.5	1.7250	1.4349	101.2755	-30.5951	0.8318
-1.0	1.5	0.5750	0.1594	1.2503	-0.3776	0.2773

## ESTIMATION

This section discusses six different parameter estimation approaches for the TEpED distribution. These include maximum likelihood, moments, least squares, weighted least squares, Cramer-von Mises, and Anderson-Darling methods.

### Method of Maximum Likelihood Estimation

Let's consider a random sample  $X_1, X_2, \dots, X_n$  from the TEpED ( $\delta$ ) distribution, where  $\delta = (\theta, \lambda)$ . The likelihood and log-likelihood functions are obtained

$$L(\delta) = \prod_{i=1}^n \frac{3}{2} \theta (e^{-3\theta x_i} - 2e^{-2\theta x_i}) (\lambda e^{-3\theta x_i} - 3\lambda e^{-2\theta x_i} + \lambda - 1)$$

and

$$\ell_n(\delta) = n \log\left(\frac{3\theta}{2}\right) + \log(e^{-3\theta \sum_{i=1}^n x_i} - 2e^{-2\theta \sum_{i=1}^n x_i}) + \log(\lambda e^{-3\theta \sum_{i=1}^n x_i} - 3\lambda e^{-2\theta \sum_{i=1}^n x_i} + \lambda - 1)$$

Then, the maximum likelihood (ML) estimators of  $\theta$  and  $\lambda$ ,  $\hat{\theta}$  and  $\hat{\lambda}$ , are the solution of the following linear equations:  $\partial \ell_n(\delta) / \partial \theta = 0$  and  $\partial \ell_n(\delta) / \partial \lambda = 0$ . The ML estimators of  $\theta$  and  $\lambda$  cannot be obtained explicitly. Therefore, they can be obtained by numerical methods. The optim command in R is used for this purpose.

### Method of Moments Estimation

Let  $X_1, X_2, \dots, X_n$  be a random sample from the TEpED distribution. The parameters  $\theta$  and  $\lambda$  were estimated using the moments method (MM), which involved solving the following pair of simultaneous equations:

$$\frac{140 - 67\lambda}{240\theta} = \frac{1}{n} \sum_{i=1}^n X_i, \tag{5}$$

and

$$\frac{4600 - 3339\lambda}{7200\theta^2} = \frac{1}{n} \sum_{i=1}^n X_i^2, \tag{6}$$

Equations 5 and 6 can be numerically solved using the Newton–Raphson method. The solutions of these two equations are the MM estimators of the parameters  $\hat{\theta}_{MM}$  and  $\hat{\lambda}_{MM}$ .

### Method of Least Squares and Weight Least Squares Estimation

Consider the order statistics of a random sample from the TEpED distribution represented by  $x_{(1:n)}, x_{(2:n)}, \dots, x_{(n:n)}$ . The least squares (LS) estimators of the TEpED parameters  $\hat{\theta}_{LS}$  and  $\hat{\lambda}_{LS}$  follow by minimizing

$$L(\theta, \lambda) = \sum_{i=1}^n \left[ F(x_{(i:n)} | \theta, \lambda) - \frac{i}{n+1} \right]^2,$$

with respect to  $\theta$  and  $\lambda$ . Alternatively, the LS estimates are obtained by solving the non-linear equations.

$$\sum_{i=1}^n \left[ F(x_{(i:n)} | \theta, \lambda) - \frac{i}{n+1} \right] \eta_1(x_{(i:n)} | \theta, \lambda) = 0, \tag{7}$$

$$\sum_{i=1}^n \left[ F(x_{(i:n)} | \theta, \lambda) - \frac{i}{n+1} \right] \eta_2(x_{(i:n)} | \theta, \lambda) = 0, \tag{8}$$

where

$$\eta_1(x_{(i:n)} | \theta, \lambda) = \frac{\partial F(x_{(i:n)})}{\partial \theta} = \frac{3}{2} x (e^{-3\theta x} - 3e^{-2\theta x}) (\lambda e^{-3\theta x} + \lambda - 1 - 3\lambda e^{-2\theta x})$$

$$\eta_2(x_{(i:n)} | \theta, \lambda) = \frac{\partial F(x_{(i:n)})}{\partial \lambda} = \frac{1}{4} (e^{-3\theta x} - 3e^{-2\theta x} + 2) (e^{-3\theta x} - 3e^{-2\theta x}).$$

As a result of solving the two Equations 7 and 8, LS estimators of the  $\hat{\theta}_{LS}$  and  $\hat{\lambda}_{LS}$  parameters are obtained.

The weighted least squares (WLS) estimators of the TEpED parameters  $\hat{\theta}_{WLS}$  and  $\hat{\lambda}_{WLS}$  can be obtained by minimizing the Equation 9 with respect to the parameters

$$W(\theta, \lambda) = \sum_{i=1}^n \frac{(n+1)^2(n+2)}{i(n-i+1)} \left[ F(x_{(i:n)}|\theta, \lambda) - \frac{i}{n+1} \right]^2. \quad (9)$$

Also, the WLS estimators can be obtained by solving the non-linear equation in Equation 10 and 11

$$\sum_{i=1}^n \frac{(n+1)^2(n+2)}{i(n-i+1)} \left[ F(x_{(i:n)}|\theta, \lambda) - \frac{i}{n+1} \right] \eta_1(x_{(i:n)}|\theta, \lambda) = 0, \quad (10)$$

and

$$\sum_{i=1}^n \frac{(n+1)^2(n+2)}{i(n-i+1)} \left[ F(x_{(i:n)}|\theta, \lambda) - \frac{i}{n+1} \right] \eta_2(x_{(i:n)}|\theta, \lambda) = 0. \quad (11)$$

As a result of solving the two Equations 10 and 11, WLS estimators of the  $\hat{\theta}_{WLS}$  and  $\hat{\lambda}_{WLS}$  parameters are obtained.

#### Method of Cramer-Von Mises Estimation

The Cramer-von Mises estimates (CRVM) of the TEpED parameters can be obtained by minimizing Equation 12 with respect to the following:

$$C(\theta, \lambda) = \frac{1}{12n} + \sum_{i=1}^n \left[ F(x_{(i:n)}|\theta, \lambda) - \frac{2i-1}{2n} \right]^2. \quad (12)$$

Alternatively, the CRVM can be obtained by solving Equation 13 and 14 numerically.

$$\sum_{i=1}^n \left[ F(x_{(i:n)}|\theta, \lambda) - \frac{2i-1}{2n} \right] \eta_1(x_{(i:n)}|\theta, \lambda) = 0, \quad (13)$$

and

$$\sum_{i=1}^n \left[ F(x_{(i:n)}|\theta, \lambda) - \frac{2i-1}{2n} \right] \eta_2(x_{(i:n)}|\theta, \lambda) = 0. \quad (14)$$

As a result of solving the two Equations 13 and 14, CRVM estimators of the  $\hat{\theta}_{CRVM}$  and  $\hat{\lambda}_{CRVM}$  parameters are obtained.

#### Method of Anderson Darling Estimation

The Anderson Darling (AD) estimates of the TEpED parameters can be obtained by minimizing Equation 15 with respect to the following:



$$A(\theta, \lambda) = -n - \frac{1}{n} \sum_{i=1}^n (2i - 1) \{ \log[F(x_{(i:n)}|\theta, \lambda)] + \log[\bar{F}(x_{(i:n)}|\theta, \lambda)] \} \quad (15)$$

with concerning to  $\theta$  and  $\lambda$ .

$$\sum_{i=1}^n (2i - 1) \left[ \frac{\eta_1(x_{(i:n)}|\theta, \lambda)}{F(x_{(i:n)}|\theta, \lambda)} - \frac{\eta_1(x_{(n+1-i:n)}|\theta, \lambda)}{\bar{F}(x_{(n+1-i:n)}|\theta, \lambda)} \right] = 0, \quad (16)$$

and

$$\sum_{i=1}^n (2i - 1) \left[ \frac{\eta_2(x_{(i:n)}|\theta, \lambda)}{F(x_{(i:n)}|\theta, \lambda)} - \frac{\eta_2(x_{(n+1-i:n)}|\theta, \lambda)}{\bar{F}(x_{(n+1-i:n)}|\theta, \lambda)} \right] = 0, \quad (17)$$

where

$$\bar{F}(x_{(n+1-i:n)}|\theta, \lambda) = \frac{1}{4} \left( (2 - 2\lambda)(3e^{-2\theta x} - e^{-3\theta x}) + \lambda(3e^{-2\theta x} - e^{-3\theta x})^2 \right).$$

As a result of solving the two Equations 16 and 17, AD estimators of the  $\hat{\theta}_{AD}$  and  $\hat{\lambda}_{AD}$  parameters are obtained.

### SIMULATION STUDY

In this section, we conducted a simulation experiment using ML, MM, LS, WLS, CRVM, and AD estimation methods to assess the performance of predictors on the TEped distribution. For the simulation study, we generated 5000 samples of the TEped distribution with sample sizes of  $n = 50, 100, 200, 300, 500$ , and selected values of  $\theta = 1.5, 0.5$  and  $\lambda = -0.5, 0.5$ . Estimation performance was assessed using averages, incorporating metrics such as average absolute biases (ABBs), mean squared errors (MSEs), and mean relative errors (MREs) for all methods. These criteria are computed as follows:

$$\overline{ABB}_s = \frac{1}{N} \sum_{i=1}^n |\hat{\delta}_1 - \delta|,$$

$$\overline{MSE}_s = \frac{1}{N} \sum_{i=1}^n (\hat{\delta}_1 - \delta)^2,$$

$$\overline{MRE}_s = \frac{1}{N} \sum_{i=1}^n \frac{|\hat{\delta}_1 - \delta|}{\delta}.$$

Where  $\delta = (\theta, \lambda)$ , and  $\hat{\delta} = (\hat{\theta}, \hat{\lambda})$ . The results have been reported in Tables 2-5.

**V. INTERNATIONAL APPLIED STATISTICS CONGRESS (UYIK - 2024)**  
**İstanbul / Türkiye, May 21-23, 2024**

**Table 2.** MSE, ABB, and MRE values of TEpED distribution for  $\theta = 1.5$  and  $\lambda = -0.5$ .

n		$\hat{\theta}_{ML}$	$\hat{\lambda}_{ML}$	$\hat{\theta}_{MM}$	$\hat{\lambda}_{MM}$	$\hat{\theta}_{LS}$	$\hat{\lambda}_{LS}$	$\hat{\theta}_{WLS}$	$\hat{\lambda}_{WLS}$	$\hat{\theta}_{CRVM}$	$\hat{\lambda}_{CRVM}$	$\hat{\theta}_{AD}$	$\hat{\lambda}_{AD}$
50	Averages	1.4858	-0.4326	1.5185	-0.4858	1.5483	-0.4556	1.4921	-0.3888	1.4922	-0.3890	1.4453	-0.3828
	$MSE_s$	0.0532	0.0808	0.0645	0.1043	0.0153	0.0111	0.0712	0.1108	0.0709	0.1102	0.0602	0.1014
	$ABB_s$	0.1821	0.2214	0.2008	0.2574	0.0982	0.0817	0.2118	0.2538	0.2118	0.2535	0.1955	0.2364
	$MRE_s$	0.1214	-0.4428	0.1339	-0.5147	0.0654	-0.1634	0.1412	-0.5075	0.1412	-0.5070	0.1303	-0.4728
100	Averages	1.5024	-0.4826	1.5184	-0.5083	1.5217	-0.4798	1.5105	-0.4675	1.5102	-0.4672	1.4857	-0.4628
	$MSE_s$	0.0288	0.0475	0.0390	0.0694	0.0073	0.0050	0.0378	0.0573	0.0380	0.0577	0.0309	0.0499
	$ABB_s$	0.1337	0.1663	0.1567	0.2096	0.0680	0.0555	0.1542	0.1829	0.1545	0.1833	0.1393	0.1703
	$MRE_s$	0.0891	-0.3326	0.1044	-0.4192	0.0453	-0.1109	0.1028	-0.3659	0.1030	-0.3666	0.0929	-0.3407
200	Averages	1.5066	-0.4995	1.5166	-0.5157	1.5097	-0.4908	1.5099	-0.4929	1.5100	-0.4930	1.4985	-0.4909
	$MSE_s$	0.0146	0.0240	0.0219	0.0424	0.0034	0.0023	0.0188	0.0294	0.0188	0.0293	0.0154	0.0249
	$ABB_s$	0.0960	0.1223	0.1177	0.1640	0.0464	0.0376	0.1089	0.1360	0.1088	0.1358	0.0986	0.1251
	$MRE_s$	0.0640	-0.2447	0.0785	-0.3280	0.0310	-0.0752	0.0726	-0.2719	0.0725	-0.2717	0.0657	-0.2502
300	Averages	1.5043	-0.5006	1.5113	-0.5119	1.5060	-0.4941	1.5054	-0.4947	1.5055	-0.4947	1.4985	-0.4983
	$MSE_s$	0.0097	0.0161	0.0146	0.0294	0.0024	0.0016	0.0126	0.0200	0.0126	0.0200	0.0104	0.0171
	$ABB_s$	0.0783	0.1014	0.0963	0.1369	0.0393	0.0317	0.0896	0.1117	0.0896	0.1117	0.0815	0.1036
	$MRE_s$	0.0522	-0.2027	0.0642	-0.2738	0.0262	-0.0635	0.0597	-0.2235	0.0597	-0.2234	0.0543	-0.2071
500	Averages	1.5012	-0.5005	1.5055	-0.5076	1.5028	-0.4972	1.5015	-0.4964	1.5015	-0.4964	1.4975	-0.4964
	$MSE_s$	0.0056	0.0095	0.0086	0.0176	0.0014	0.0009	0.0072	0.0115	0.0072	0.0115	0.0060	0.0099
	$ABB_s$	0.0595	0.0781	0.0733	0.1061	0.0300	0.0241	0.0677	0.0859	0.0677	0.0859	0.0617	0.0798
	$MRE_s$	0.0396	-0.1561	0.0489	-0.2121	0.0200	-0.0483	0.0451	-0.1717	0.0451	-0.1717	0.0412	-0.1596

**V. INTERNATIONAL APPLIED STATISTICS CONGRESS (UYIK - 2024)**  
**İstanbul / Türkiye, May 21-23, 2024**

**Table 3.** MSE, ABB, and MRE values of TEpED distribution for  $\theta = 1.5$  and  $\lambda = 0.5$ .

n		$\hat{\theta}_{ML}$	$\hat{\lambda}_{ML}$	$\hat{\theta}_{MM}$	$\hat{\lambda}_{MM}$	$\hat{\theta}_{LS}$	$\hat{\lambda}_{LS}$	$\hat{\theta}_{WLS}$	$\hat{\lambda}_{WLS}$	$\hat{\theta}_{CRVM}$	$\hat{\lambda}_{CRVM}$	$\hat{\theta}_{AD}$	$\hat{\lambda}_{AD}$
50	Averages	1.8439	0.1055	1.9179	0.0247	1.4878	0.4877	1.7230	0.2636	1.6992	0.2825	1.7008	0.2324
	$MSE_S$	0.2462	0.2742	0.3273	0.3662	0.0123	0.0127	0.1680	0.2003	0.1459	0.1846	0.1562	0.2117
	$ABB_S$	0.4079	0.4356	0.4653	0.5193	0.0880	0.0883	0.2901	0.2950	0.2611	0.2748	0.2927	0.3183
	$MRE_S$	0.2719	0.8712	0.3102	1.0386	0.0587	0.1766	0.1934	0.5899	0.1741	0.5496	0.1951	0.6366
100	Averages	1.7827	0.2031	1.8493	0.1325	1.4925	0.4929	1.6545	0.3403	1.6667	0.3313	1.6854	0.2897
	$MSE_S$	0.1788	0.1785	0.2243	0.2217	0.0064	0.0065	0.1000	0.1211	0.1124	0.1334	0.1237	0.1491
	$ABB_S$	0.3510	0.3561	0.3886	0.4004	0.0635	0.0639	0.2081	0.2214	0.2302	0.2406	0.2617	0.2768
	$MRE_S$	0.2340	0.7122	0.2590	0.8007	0.0423	0.1279	0.1387	0.4428	0.1534	0.4811	0.1745	0.5535
200	Averages	1.7107	0.2849	1.7660	0.2265	1.4938	0.4939	1.6049	0.3924	1.6227	0.3788	1.6383	0.3501
	$MSE_S$	0.1171	0.1168	0.1340	0.1291	0.0034	0.0034	0.0633	0.0786	0.0821	0.0948	0.0807	0.0955
	$ABB_S$	0.2843	0.2885	0.2992	0.2999	0.0465	0.0466	0.1659	0.1812	0.1877	0.1997	0.2044	0.2181
	$MRE_S$	0.1895	0.5771	0.1995	0.5999	0.0310	0.0933	0.1106	0.3625	0.1252	0.3995	0.1363	0.4363
300	Averages	1.6677	0.3284	1.7222	0.2705	1.4929	0.4932	1.5636	0.4270	1.5558	0.4333	1.6007	0.3859
	$MSE_S$	0.0915	0.0918	0.0977	0.0945	0.0023	0.0024	0.0311	0.0427	0.0246	0.0376	0.0476	0.0608
	$ABB_S$	0.2514	0.2569	0.2538	0.2539	0.0386	0.0388	0.1071	0.1274	0.0986	0.1199	0.1529	0.1698
	$MRE_S$	0.1676	0.5138	0.1692	0.5078	0.0258	0.0777	0.0714	0.2548	0.0657	0.2399	0.1019	0.3395
500	Averages	1.6279	0.3701	1.6747	0.3200	1.4944	0.4945	1.5313	0.4585	1.5489	0.4450	1.5957	0.3973
	$MSE_S$	0.0654	0.0664	0.0656	0.0642	0.0014	0.0014	0.0107	0.0180	0.0244	0.0331	0.0420	0.0492
	$ABB_S$	0.2140	0.2189	0.2065	0.2068	0.0300	0.0302	0.0641	0.0820	0.1014	0.1173	0.1465	0.1573
	$MRE_S$	0.1426	0.4378	0.1377	0.4137	0.0200	0.0605	0.0427	0.1641	0.00676	0.2346	0.0976	0.3147



**V. INTERNATIONAL APPLIED STATISTICS CONGRESS (UYIK - 2024)**  
**İstanbul / Türkiye, May 21-23, 2024**

**Table 4.** MSE, ABB, and MRE values of TEpED distribution for  $\theta = 0.5$  and  $\lambda = -0.5$ .

n		$\hat{\theta}_{ML}$	$\hat{\lambda}_{ML}$	$\hat{\theta}_{MM}$	$\hat{\lambda}_{MM}$	$\hat{\theta}_{LS}$	$\hat{\lambda}_{LS}$	$\hat{\theta}_{WLS}$	$\hat{\lambda}_{WLS}$	$\hat{\theta}_{CRVM}$	$\hat{\lambda}_{CRVM}$	$\hat{\theta}_{AD}$	$\hat{\lambda}_{AD}$
50	Averages	0.4994	-0.4083	0.5100	-0.4596	0.5390	-0.4884	0.5070	-0.3864	0.5073	-0.3877	0.4888	-0.3713
	$MSE_s$	0.0062	0.0889	0.0770	0.1104	0.0052	0.0004	0.0078	0.0987	0.0078	0.0967	0.0066	0.0958
	$ABB_s$	0.0625	0.2277	0.0697	0.2622	0.0559	0.0158	0.0693	0.2423	0.0692	0.2425	0.0643	0.2366
	$MRE_s$	0.1250	-0.4554	0.1395	-0.5245	0.1117	-0.0316	0.1387	-0.4847	0.1385	-0.4849	0.1286	-0.4731
100	Averages	0.5017	-0.4722	0.5082	-0.5041	0.5161	-0.4952	0.5040	-0.4579	0.5034	-0.4558	0.4962	-0.4547
	$MSE_s$	0.0033	0.0456	0.0045	0.0719	0.0021	0.0002	0.0040	0.0517	0.0041	0.0527	0.0033	0.0450
	$ABB_s$	0.0450	0.1637	0.0535	0.2131	0.0362	0.0099	0.0501	0.1755	0.0505	0.1795	0.0457	0.1655
	$MRE_s$	0.0899	-0.3274	0.1071	-0.4262	0.0724	-0.0198	0.1001	-0.3551	0.1010	-0.3589	0.0915	-0.3309
200	Averages	0.5009	-0.4930	0.5046	-0.5117	0.5062	-0.4981	0.5022	-0.4876	0.5029	-0.4905	0.4985	-0.4861
	$MSE_s$	0.0015	0.0221	0.0022	0.0405	0.0010	0.0000	0.0020	0.0271	0.0019	0.0242	0.0016	0.0225
	$ABB_s$	0.0312	0.1181	0.0378	0.1612	0.0247	0.0066	0.0353	0.1296	0.0341	0.1237	0.0320	0.1195
	$MRE_s$	0.0623	-0.2362	0.0756	-0.3223	0.0493	-0.0133	0.0707	-0.2593	0.0683	-0.2473	0.0640	-0.2390
300	Averages	0.5015	-0.5006	0.5038	-0.5124	0.5037	-0.4988	0.5021	-0.4960	0.5023	-0.4965	0.4996	-0.4947
	$MSE_s$	0.0011	0.0161	0.0016	0.0293	0.0006	0.0000	0.0014	0.0192	0.0013	0.0186	0.0012	0.0172
	$ABB_s$	0.0261	0.1014	0.0320	0.1369	0.0202	0.0054	0.0296	0.1100	0.0293	0.1083	0.0271	0.1033
	$MRE_s$	0.0522	-0.2029	0.0641	-0.2739	0.0404	-0.0109	0.0592	-0.2200	0.0585	-0.2167	0.0543	-0.2065
500	Averages	0.5002	0.5005	0.5020	0.5009	0.5015	0.4995	0.5006	0.4983	0.5004	-0.4975	0.4989	-0.4967
	$MSE_s$	0.0006	0.0094	0.0009	0.0175	0.0004	0.0000	0.0008	0.0110	0.0008	0.0114	0.0007	0.0098
	$ABB_s$	0.0197	0.0771	0.0241	0.1054	0.0155	0.0041	0.0225	0.0833	0.0228	0.0849	0.0207	0.0788
	$MRE_s$	0.0522	-0.2029	0.0641	-0.2739	0.0404	-0.0109	0.0592	-0.2200	0.0585	-0.2167	0.0543	-0.2065

**V. INTERNATIONAL APPLIED STATISTICS CONGRESS (UYIK - 2024)**  
**İstanbul / Türkiye, May 21-23, 2024**

**Table 5.** MSE, ABB, and MRE values of TEpED distribution for  $\theta = 0.5$  and  $\lambda = 0.5$ .

n		$\hat{\theta}_{ML}$	$\hat{\lambda}_{ML}$	$\hat{\theta}_{MM}$	$\hat{\lambda}_{MM}$	$\hat{\theta}_{LS}$	$\hat{\lambda}_{LS}$	$\hat{\theta}_{WLS}$	$\hat{\lambda}_{WLS}$	$\hat{\theta}_{CRVM}$	$\hat{\lambda}_{CRVM}$	$\hat{\theta}_{AD}$	$\hat{\lambda}_{AD}$
50	Averages	0.6334	0.1336	0.6617	0.0424	0.5131	0.5047	0.5259	0.4595	0.5160	0.4841	0.5259	0.4153
	$MSE_S$	0.0366	0.2475	0.0471	0.3419	0.0045	0.0005	0.0078	0.0309	0.0051	0.0130	0.0091	0.0508
	$ABB_S$	0.1539	0.4155	0.1749	0.5072	0.0522	0.0175	0.0633	0.0936	0.0522	0.0606	0.0641	0.1264
	$MRE_S$	0.3078	0.8310	0.3498	1.0144	0.1044	0.0349	0.1265	0.1872	0.1045	0.1212	0.1283	0.2528
100	Averages	0.6015	0.2033	0.6276	0.1199	0.4998	0.5001	0.5072	0.4724	0.5074	0.4717	0.5282	0.3946
	$MSE_S$	0.0246	0.1898	0.0297	0.2329	0.0024	0.0003	0.0029	0.0136	0.0025	0.0140	0.0061	0.0537
	$ABB_S$	0.1271	0.3673	0.1397	0.4117	0.0392	0.0132	0.0383	0.0514	0.0367	0.0611	0.0550	0.1401
	$MRE_S$	0.2541	0.7347	0.2793	0.8233	0.0783	0.0264	0.0766	0.1028	0.0734	0.1222	0.1100	0.2802
200	Averages	0.5704	0.2893	0.5931	0.2173	0.4971	0.4990	0.5020	0.4819	0.5088	0.4658	0.5278	0.4065
	$MSE_S$	0.036	0.1122	0.0161	0.1335	0.0012	0.0001	0.0015	0.0074	0.0034	0.0225	0.0074	0.0484
	$ABB_S$	0.0937	0.2770	0.1034	0.3061	0.0279	0.0092	0.0282	0.0451	0.0399	0.0739	0.0563	0.1285
	$MRE_S$	0.1875	0.5540	0.2068	0.6122	0.0558	0.0185	0.0564	0.0902	0.0797	0.1477	0.1127	0.2569
3000	Averages	0.5593	0.3248	0.5767	0.2692	0.4981	0.4994	0.5011	0.4886	0.4996	0.4926	0.5069	0.4666
	$MSE_S$	0.0100	0.0841	0.0114	0.0957	0.0008	0.0000	0.0009	0.0037	0.0008	0.0016	0.0011	0.0069
	$ABB_S$	0.0806	0.2382	0.0865	0.2556	0.0226	0.0076	0.0225	0.0239	0.0219	0.0194	0.0239	0.0476
	$MRE_S$	0.1612	0.4764	0.1730	0.5113	0.0453	0.0152	0.0450	0.0478	0.0438	0.0387	0.0478	0.0952
500	Averages	0.5433	0.3709	0.5585	0.3223	0.4975	0.4992	0.4990	0.4939	0.5002	0.4910	0.5091	0.4632
	$MSE_S$	0.0071	0.0624	0.0076	0.0646	0.0004	0.0000	0.0005	0.0012	0.0008	0.0035	0.0014	0.0093
	$ABB_S$	0.0688	0.2070	0.0697	0.2065	0.0178	0.0060	0.0175	0.0149	0.0203	0.0284	0.0244	0.0578
	$MRE_S$	0.1376	0.4141	0.1394	0.4130	0.0357	0.0120	0.0349	0.0299	0.0406	0.0568	0.0489	0.1156

According to the data presented in Tables 2-5, as the sample size increases, the ABBs, MSEs, and MREs of all estimators decrease and approach almost zero. This shows that estimators are becoming more reliable and accurate in general. Also, remarkably, it has been observed that for parameters a and b, the LS method performs more effectively than other estimators.

### REAL DATA

This section investigates the flexibility of the new TEpED distribution using a real dataset and contrasts it with other competitive distributions, including the Exponential (Exp) distribution, transformed exponential (TE) distribution, exponentiated exponential (EE) distribution, transformed exponentiated Exponential (Trans. EExp) distribution, and Epanechnikov-exponential (EED) distributions. Three real data sets have been used to study the performance of the new TEpED in comparison with the exponential using the log-likelihood ( $-\ell$ ), Akaike information criteria (AIC), Bayesian information criteria (BIC), Hannan-Quinn information criterion (HQIC), and consistent Akaike information criterion (CAIC). They are given by

$$\begin{aligned} AIC &= -2\ell + 2p, & BIC &= -2\ell + p\log(n) \\ CAIC &= -2\ell + \frac{2pn}{(n-p-1)}, & HQIC &= -2\ell + 2p\log[\log(n)] \end{aligned}$$

where n is the sample size, k is the number of parameters. The smaller these statistics are, the better the fit. The ML of the model parameters, along with measures of goodness of fit, are presented for the three datasets. The goodness-of-fit performance of the new TEpED distribution has been compared with the distributions specified below.

Exponential (Exp) distribution. Its pdf is

$$f(x) = \frac{1}{\beta} e^{-\frac{x}{\beta}}, \quad \beta > 0, x > 0,$$

Transmuted exponential (TE) distribution. Its pdf is

$$f(x) = \frac{1}{\beta} e^{-\frac{x}{\beta}} \left[ 1 - \lambda + 2\lambda e^{-\frac{x}{\beta}} \right], \quad \beta > 0, x > 0, |\lambda| \leq 1,$$

Exponentiated exponential (EE) distribution. Its pdf is

$$f(x) = \alpha\beta e^{-\beta x} (1 - e^{-\beta x})^{\alpha-1}, \quad \alpha > 0, \beta > 0, x > 0,$$

Transmuted exponentiated exponential (Trans. EExp.) distribution. Its pdf is

$$f(x) = \alpha\beta e^{-\beta x} (1 - e^{-\beta x})^{\alpha-1} e^{-\beta x} \left[ 1 + \lambda - 2\lambda (1 - e^{-\beta x})^\alpha \right], \quad \alpha > 0, \beta > 0, x > 0, |\lambda| \leq 1,$$

Epanechnikov-exponential distribution (EED). Its pdf is

$$f(x) = \frac{3\alpha}{2} (2e^{-2\alpha x} - e^{-3\alpha x}), \quad \alpha > 0, x > 0,$$

**First data set:** The dataset includes the service times of 63 aircraft windshields as reported by Murthy et al. (Murthy et. al, 2004). We calculate the Kolmogorov Smirnov (KS) values for the service times of 63 aircraft wind shields, and the corresponding p-value (in parentheses) is 0.1330 (0.2149). The data is as follows; 0.046, 1.436, 2.592, 0.140, 1.492, 2.600, 0.150, 1.580, 2.670, 0.248, 1.719, 2.717, 0.280, 1.794, 2.819, 0.313, 1.915, 2.820, 0.389, 1.920, 2.878, 0.487, 1.963, 2.950, 0.622, 1.978, 3.003, 0.900, 2.053, 3.102, 0.952, 2.065, 3.304, 0.996, 2.117, 3.483, 1.003, 2.137, 3.500, 1.010, 2.141, 3.622, 1.085, 2.163, 3.665, 1.092, 2.183, 3.695, 1.152, 2.240, 4.015, 1.183, 2.341, 4.628, 1.244, 2.435, 4.806, 1.249, 2.464, 4.881, 1.262, 2.543, 5.140.



**Second data set:** The second dataset represents the fatigue fracture life of Kevlar 373/epoxy under continuous compression at a 90% strain level. This data was utilized by Barlow et al. (Barlow et. al, 1984). We calculate the KS values for the fatigue fracture life of Kevlar 373/epoxy under continuous compression, and the corresponding p-value (in parentheses) is 0.0994 (0.4412). The observations are as; 0.0251, 0.0886, 0.0891, 0.2501, 0.3113, 0.3451, 0.4763, 0.5650, 0.5671, 0.6566, 0.6748, 0.6751, 0.6753, 0.7696, 0.8375, 0.8391, 0.8425, 0.8645, 0.8851, 0.9113, 0.9120, 0.9836, 1.0483, 1.0596, 1.0773, 1.1733, 1.2570, 1.2766, 1.2985, 1.3211, 1.3503, 1.3551, 1.4595, 1.4880, 1.5728, 1.5733, 1.7083, 1.7263, 1.7460, 1.7630, 1.7746, 1.8275, 1.8375, 1.8503, 1.8808, 1.8878, 1.8881, 1.9316, 1.9558, 2.0048, 2.0408, 2.0903, 2.1093, 2.1330, 2.2100, 2.2460, 2.2878, 2.3203, 2.3470, 2.3513, 2.4951, 2.5260, 2.9911, 3.0256, 3.2678, 3.4045, 3.4846, 3.7433, 3.7455, 3.9143, 4.8073, 5.4005, 5.4435, 5.5295, 6.5541, 9.0960.

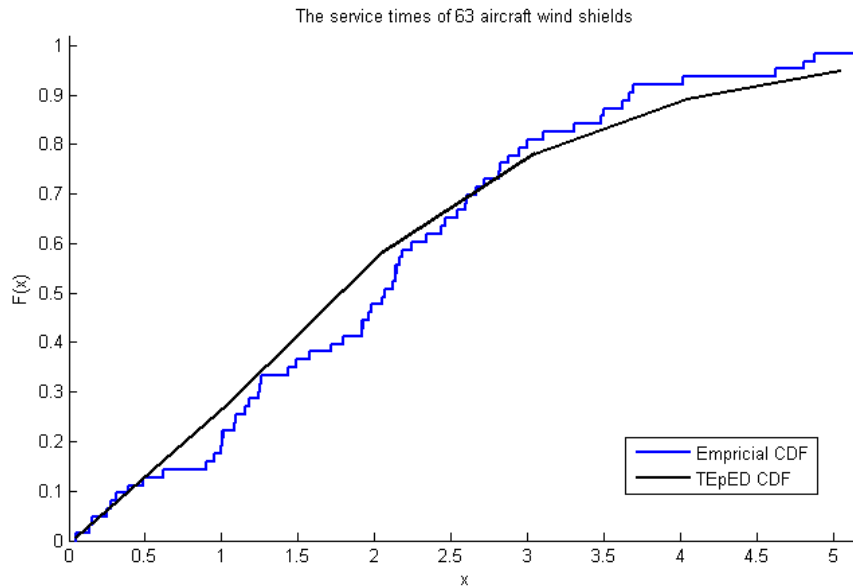
**The third data set:** The third dataset represents the survival times of 121 breast cancer patients calculated in a large hospital during the period 1929-1938 (Lee,1986). We calculate the KS values for the survival times of 121 breast cancer patients, and the corresponding p-value (in parentheses) is 0.0127(0.8463). The data set is; 0.3, 0.3, 4.0, 5.0, 5.6, 6.2, 6.3, 6. 6, 6.8, 7.4, 7.5, 8. 4, 8.4, 10.3, 11.0, 11.8, 12.2, 12.3, 13.5, 14.4, 14.4, 14.8, 15.5, 15.7, 16.2, 16.3, 16.5, 16.8, 17.2, 17.3, 17.5, 17.9, 19.8, 20.4, 20.9, 21.0, 21.0, 21.1, 23.0, 23. 4, 23.6, 24.0, 24.0, 27.9, 28.2, 29.1, 30.0, 31.0, 31.0, 32.0, 35.0, 35.0, 37.0, 37.0, 370, 38.0, 38.0, 38.0, 39.0, 39.0, 40.0, 40.0, 40.0, 41.0, 41.0, 41.0, 42.0, 43.0, 43.0, 43.0, 44.0, 45.0, 45.0, 46.0, 46.0, 47.0, 48.0, 49.0, 51.0, 51.0, 51.0, 52.0, 54.0, 55.0, 56.0, 57.0, 58.0, 59.0, 60.0, 60.0, 60.0, 61.0, 62.0, 65.0, 65.0, 67.0, 67.0, 68.0, 69.0, 78.0, 80.0, 83.0, 88.0, 89.0, 90.0, 93.0, 96.0, 103.0, 105.0, 109.0, 109.0, 111.0, 115.0,117.0, 125.0, 126.0, 127.0, 129.0, 129.0, 139.0, 154.0.

**Table 6:** The descriptive measures of the three real data sets.

	Min	Mean	Var	Skewness	Kurtosis	DI	Max
<b>Data I</b>	0.046	2.0853	1.5506	0.4292	-0.3535	0.7436	5.14
<b>Data II</b>	0.0251	1.9592	2.4774	1.9406	4.9474	1.2645	9.096
<b>Data III</b>	0.3	46.3289	1244.464	1.0303	0.33461	26.815	154

**Table 7:** The ML estimates, and goodness of fit measures for the service times of 63 aircraft windshields

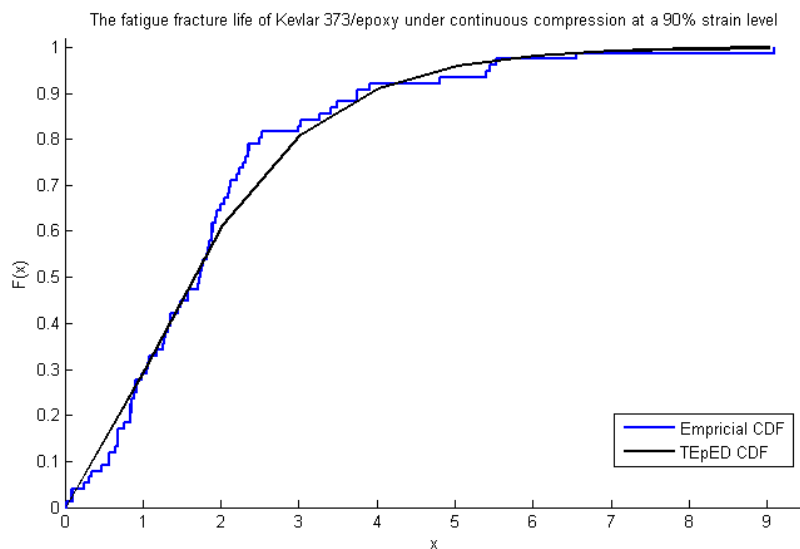
Model	Estimate				AIC	BIC	HQIC	CAIC
	$\theta$	$\lambda$	$\alpha$	$-\ell$				
<b>TEpED</b>	0.3865	-0.8171		101.8202	207.6404	207.2391	204.6609	207.8404
<b>EED</b>	0.2860			107.1816	216.3632	216.1625	214.8734	216.4288
<b>Exp</b>	0.4796			109.2986	220.5972	220.3965	219.1074	220.6628
<b>TE</b>	1.4726	-0.8695		102.9673	209.9346	209.5333	206.9554	210.1346
<b>EE</b>	1.8978	0.6921		103.5466	211.0932	210.6919	208.1137	211.2932
<b>Trans.EExp</b>	1.5384	0.7720	-0.6024	101.9002	209.8004	209.1984	205.3311	210.2072



**Figure 3:** Empirical and TEpED distributions based on the first data set.

**Table 8:** The ML estimates, and goodness of fit measures for the fatigue fracture life of Kevlar 373/epoxy under continuous compression.

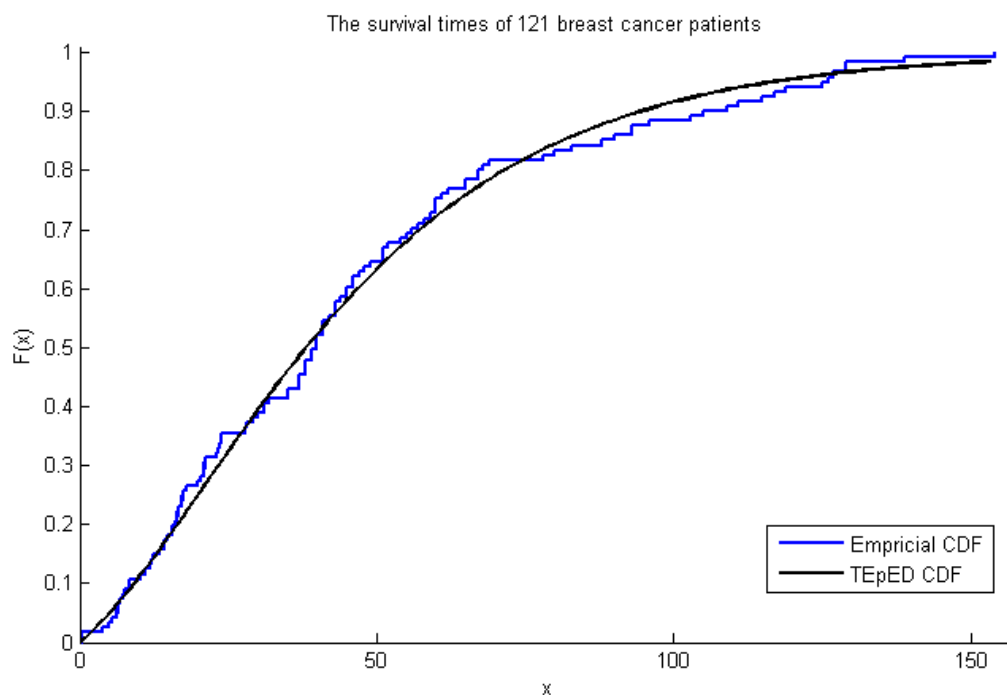
Model	Estimate				AIC	BIC	HQIC	CAIC
	$\theta$	$\lambda$	$\alpha$	$-\ell$				
TEpED	0.4117	-0.7883		121.3902	246.7804	246.5420	243.8778	246.9448
EED	0.3026			125.5048	253.0096	252.8904	251.5583	253.0637
Exp	0.5104			127.1148	256.2286	256.1094	254.7773	256.2827
TE	0.1763	-0.8487		121.5166	247.0332	246.7948	244.1306	247.1976
EE	1.7094	0.7028		122.2436	248.2488	248.2488	245.5846	248.6516
Trans.EExp	1.7281	0.4740	0.8075	131.9389	249.5202	249.5202	245.5239	250.2111



**Figure 4:** Empirical and TEpED distributions based on the second data set

**Table 9:** The ML estimates, and goodness of fit measures for the survival times of 121 breast cancer patients.

Model	Estimate				AIC	BIC	HQIC	CAIC
	$\theta$	$\lambda$	$\alpha$	$-\ell$				
TEpED	0.0165	-0.6626		579.3706	1162.7412	1162.9068	1160.0158	1162.8429
EED	0.0127			583.1323	1168.2646	1168.3474	1166.9019	1168.2982
Exp	0.0215			585.4297	1172.8594	1172.9422	1171.4967	1172.8930
TE	33.4877	-0.7780		579.3801	1162.7602	1162.9258	1160.0348	1162.8619
EE	1.5302	0.0278		580.4743	1164.9486	1165.1142	1162.2232	1165.0503
Trans.EEExp	1.0537	0.0308	-0.7451	579.4472	1164.8944	1165.1428	1160.8063	1165.0995



**Figure 5:** Empirical and TEpED distributions based on the third data set

According to the p-value of the KS statistic, it was indicated that the TEpED distribution is quite appropriate for these three datasets ( $p > 0.05$ ). Based on the results presented in Tables 7- 9, the TEpED achieved the  $-\ell$  value. Additionally, upon examination of discrimination criteria, minimum values were observed for the AIC, BIC, HQIC, and CAIC criteria compared to other exponential distributions. Figures 3-5 suggest that the TEpED distribution could be a suitable alternative for modeling real data.

## CONCLUSION

In this study, a new generalization, the transformed Epanechnikov exponential distribution, is introduced. Properties of this new distribution, such as survival, cumulative distribution, hazard rate functions, and expected value, are presented. Statistical inferences regarding distribution parameters are discussed with six estimation methods: maximum likelihood, moments, least squares, weighted least squares, Cramer-Von Mises, and Anderson Darling methods. A detailed Monte Carlo simulation study was conducted to evaluate the performance of the estimation methods, and it was stated that the least



squares method was better than others. Additionally, the new distribution was examined on three different real data sets in terms of discrimination criteria. The transformed Epanechnikov exponential distribution has been observed to be more flexible than other exponential distributions. Today, as data diversity increases, it is stated as an important result that the transformed family used in this study can be adapted to existing and especially newly derived continuous distributions in future research.

### References

- Abdul-Moniem IB, Seham M, 2015. Transmuted gompertz distribution. *Computational and Applied Mathematics Journal*, 1(3), 88-96.
- Alkhazaal A, Al-Zoubi L, 2021. Epanechnikov-exponential distribution: properties and applications. *General Mathematics*, 29(1), 13-29.
- Aryal GR, Tsokos CP, 2011. Transmuted Weibull distribution: A generalization of the Weibull probability distribution. *European Journal of pure and applied mathematics*, 4(2), 89-102.
- Ashour SK, Eltehiwy MA, 2013a. Transmuted lomax distribution. *American Journal of Applied Mathematics and Statistics*, 1(6), 121-127.
- Ashour SK, Eltehiwy MA, 2013b. Transmuted exponentiated modified Weibull distribution. *International Journal of Basic and Applied Sciences*, 2(3), 258.
- Barlow RE, Toland RH, Freeman T, 1984. A Bayesian analysis of stress rupture life of Kevlar 49/epoxy spherical pressure vessels, In: *Proceedings. conference on applications of statistics*, Marcel Dekker, New York.
- Elbatal I, Diab LS, Alim NA, 2013. Transmuted generalized linear exponential distribution. *International Journal of Computer Applications*, 83(17), 29-37.
- Hussian MA, 2014. Transmuted exponentiated gamma distribution: A generalization of the exponentiated gamma probability distribution. *Applied Mathematical Sciences*, 8(27), 1297-13.
- Khan MS, King R, 2013. Transmuted modified Weibull distribution: A generalization of the modified Weibull probability distribution. *European Journal of pure and applied mathematics*, 6(1), 66-88.
- Lee ET, 1986. *Statistical methods for survival data analysis*. IEEE Transactions on Reliability, 35(1), 123-123. Conclusion.
- Merovci F, 2013. Transmuted rayleigh distribution. *Austrian Journal of Statistics*, 42(1), 21-31.
- Merovci F, Puka L, 2014. Transmuted pareto distribution. In *ProbStat Forum* (Vol. 7, No. 1, pp. 1-11).
- Murthy DP, Xie M, Jiang R, 2004. *Weibull models*. John Wiley and Sons.
- Oguntunde PE, Adejumo AO, 2015. The transmuted inverse exponential distribution. *International Journal of Advanced Statistics and Probability*, 3(1), 1-7.
- Shaw WT, Buckley IR, 2009. The alchemy of probability distributions: beyond Gram-Charlier expansions, and a skew kurtotic-normal distribution from a rank transmutation map. arXiv preprint arXiv:0901.0434.

### Acknowledgment

The authors are thankful to the referees for their valuable remarks, comments and suggestions that led to the improvement of the presentation of the research work to this form.

### Conflict of Interest

The authors declare no conflict of interest.

## The Role of Fuzzy Regression and Machine Learning Algorithms in Risk Management: A Review for the Fields of Health, Agriculture and Project Management

**Derviş Topuz**<sup>1\*</sup>

<sup>1</sup> Niğde Ömer Halisdemir University, Niğde Zübeyde Hanım Vocational School of Health Services,  
Department of Health Services Science, 51200, Niğde, Türkiye

\*Corresponding author e-mail: topuz@ohu.edu.tr

### ***Abstract***

*In today's complex and uncertain world, the use of data analysis and modeling methods in risk management is becoming increasingly important. Especially in fields such as health, agriculture and project management, dealing with uncertainties and making the right decisions is critical. Fuzzy regression stands out as a regression technique used when working with uncertain data. Machine learning algorithms offer powerful tools for analyzing large data sets and predicting future events. These techniques can be used to address uncertainties, increase efficiency and make the right decisions. It has applications in various areas in the field of healthcare, such as estimating disease risks, patient density predictions, treatment effectiveness and planning, and patient satisfaction predictions. It also has many application areas, such as increasing efficiency in agriculture or reducing risks in project management.*

*In this study, the role and sample applications of fuzzy regression and machine learning algorithms in risk management in fields such as health, agriculture and project management were examined. Additionally, the basic principles of fuzzy regression and its relationship with machine learning are discussed. The use of these techniques in future risk management applications is expected to become more widespread and their future development is emphasized.*

**Keywords:** *Machine Learning Algorithms, Health, Agriculture, Project Management, Risk Management.*

### **GİRİŞ**

Günümüzün karmaşık ve belirsiz dünyasında, veri analizi ve modelleme yöntemlerinin risk yönetiminde kullanımı giderek önem kazanmaktadır. Özellikle sağlık, tarım ve proje yönetimi gibi alanlarda, belirsizliklerle baş etmek ve doğru kararlar almak risk yönetiminde kritik öneme sahiptir. Söz konusu alanlar, önemli belirsizliklerle karakterize edilen karmaşık zorluklarla karşı karşıyadır. Çünkü risk yönetimi, karşılaşılan belirsizlikleri minimize etme ve potansiyel tehlikeleri en aza indirme sürecidir. Geleneksel risk yönetimi ve modelleme teknikleri genellikle belirli senaryoları ele alırken çoğu zaman bu belirsizlikleri etkili bir şekilde gidermede başarısız olur. Bulanık regresyon ve makine öğrenme gibi modern teknikler, daha karmaşık veri setlerinden anlamlı bilgiler çıkararak daha kapsamlı bir risk tahminleri yapabilir ve karar vericilere daha iyi bilgi sağlayabilir. Bu modern teknikler, risk yönetimi sürecinde ve risk tahminlerinde kritik öneme sahip olması nedeniyle kullanılmaya başlanmıştır (Kaya ve Aksoy, 2020; Yılmaz ve Demir, 2020).

Umut verici bu çalışma, bir alternatif olarak yeterince kullanılmayan bulanık regresyon ve makine öğrenimi algoritmalarını araştırmaktır. Her ne kadar bulanık regresyon ve makine öğrenme algoritmalarının mantığının potansiyeli geniş çapta kabul edilse de, yetenekleri sağlık, tarım ve proje yönetimi gibi alanlarda uygulamalarını gerçekten geliştirebilir mi?. Yaklaşımlar, hastalıkların risk tahminlerinde, hastalık teşhisi ve tedavi planlamasında veya tedaviye verilen yanıtların tahmin edilmesinde uygulanabilmektedir (Yıldız ve Karaman, 2022; Yılmaz ve Demir, 2023). Örneğin, diyabet

veya kalp hastalığı gibi kronik hastalıkların yönetimi veya yaşlanma sürecindeki bireylerin bakım ihtiyaçlarının belirlenmesi gibi durumlarda, yaşlı bireylerin düşme riskini belirlemek ve önlemek için kullanılabilir. Bir hastanın yaş, cinsiyet demografik özellikleri, genetik geçmişi ve yaşam tarzı, tıbbi geçmişi, aile öyküsü ve diğer sağlık göstergeleri gibi birçok faktörleri bulanık regresyon ve makine öğrenim algoritmaları ile analiz ederek, hastanın gelecekteki kalp hastalığı riski gibi hastalık risklerini tahmin etmek yönetmek ve tıbbi görüntüleri analiz etmek mümkün olur. Ayrıca bir hastanın röntgen veya MR görüntülerinden, kanserli hücrelerin veya diğer anormalliklerin tespit edilmesi gibi, teşhis süreçlerinde yardımcı olabilir. Bu tür amaçlara ulaşmak için hastalık riskini etkileyen birçok faktörün belirsizliği bulunabilir ve bulanık regresyon ve makine öğrenimi algoritmaları, bu faktörler arasındaki ilişkileri modellemek için ideal bir seçenek olabilir. Geçerli ve güvenilir olarak hesaplanabilen bu tür bilgiler, doktorların hastalarına daha kişiselleştirilmiş bir tedavi planı oluşturmalarına yardımcı olabilir.

Tarım alanında ise verimliliği artırmak, bitkisel üretimdeki doğal risk faktörleri, hastalık ve zararlıları, don, kuraklık, dolu, yangın ve hastalık risk tahminleri, ürün kalitesi ve verimlilik gibi amaçların tespit edilmesinde kullanılabilir (Demir ve Aydın, 2018; Kaya ve Aksoy, 2020). Tarım arazilerinin verimliliğini artırmak için, bir tarım işletmesi, toprak verilerini, iklim koşullarını, bitki özelliklerini, bitki türlerini, bitki hastalıklarını ve gübre kullanımı gibi birçok faktörü içeren karmaşık bir veri setini makine öğrenme algoritmaları ile analiz ederek, bir ürünün verimliliğini tahmin edebilir (Kaya ve Yıldız, 2020). Bu bilgi, çiftçilere daha verimli bir üretim planı oluşturmalarına yardımcı olabilir. Ayrıca, bitki hastalıklarının erken teşhisi ve müdahalesi için, bitki sağlığı verileri ve meteorolojik veriler kullanılarak hastalık tahmin modelleri geliştirilebilir.

Proje yönetimi alanında, zaman ve maliyet tahminleri, risk yönetimi ve kaynak planlaması gibi alanlarda kullanılabilir. Proje yönetiminde riskleri azaltmak için bu tekniklerin kullanılmasının kritik önemi bulunmaktadır (Kaya ve Demir, 2019; Karaman ve Aydın, 2021). Örneğin, bir inşaat firması, geçmiş projelerden elde edilen verileri kullanarak, daha doğru bir zaman çizelgesi oluşturmak için bir tahmin modeli oluşturulabilir. Bu bilgi, proje yöneticilerine daha doğru bir proje planı oluşturmalarına yardımcı olabilir. Ayrıca, projenin başarı olasılığını artırmak için risk faktörleri belirlenebilir ve bu faktörlerin etkileri değerlendirilebilir.

Sonuç olarak, bulanık regresyon ve makine öğrenme algoritmaları büyük veri setlerinin analiz edilmesi ve gelecekteki olayların risk tahmini için karmaşık desenleri ve ilişkileri öğrenebilmede güçlü bir araç olarak kullanılabilir. Geleneksel regresyon yöntemleri genellikle veriler arasındaki doğrusal ilişkiyi modellemeye dayanırken, bulanık regresyon ve makine öğrenim algoritmaları belirsizlikleri daha iyi ele alabilir ve karmaşık ilişkileri daha geçerli ve güvenilir bir şekilde yakalayabilir. Bu çalışmada, bulanık regresyon ve makine öğrenme algoritmalarının sağlık, tarım, proje ve risk yönetimi alanlarındaki genel önemi vurgulanmış ve karmaşık veri setlerinden anlamlı bilgiler çıkarmak için değerli bir araç olduğu detaylı bir şekilde ele alınmıştır. Tekniklerin risk yönetimi alanındaki rolü, bugünkü kullanım alanlarındaki başarısının yanı sıra gelecekteki potansiyel gelişimleri ve yeni uygulama alanları ele alınmıştır. Bu tekniklerin, karmaşık veri setlerini analiz etmek, gelecekteki olayları tahmin etmek ve riskleri minimize etmek için güçlü araçlar sunup sunmadığı detaylı bir şekilde incelenmiştir.

## **MATERYAL VE METOD**

### **Materyal**

Çalışmada kullanılan veri seti, Niğde Eğitim Araştırma Hastanesi'nde 2023 yılı Ocak-Aralık ayı arasında doğan ve doğum ağırlığı 2500 gramın üzerinde olan yenidoğanların bir takım özellikleri ile Holştayn ineklerin laktasyon dönemi boyunca sağlanan çeşitli özelliklerine ait verileri içermektedir. Çalışmamızda, kullanım kolaylığı, popülerliği ve Python ile oldukça uyumlu şekilde local web serverde çalışması sebebiyle Streamlit kütüphanesi kullanıldı



## Metod

Bulanık regresyon analiz yöntemleri, makine öğrenimi alanında önemli bir konumdadır ve çeşitli regresyon yöntemleri arasında kendine özgü bir yere sahiptir. Geleneksel regresyon analiz yöntemlerinden farklı olarak, belirsizlik ve kesin olmayan verilerle çalışabilme yeteneğine sahip olmasıyla öne çıkar. Modele ait fonksiyon;

$$f = X \times \tilde{A} \rightarrow \tilde{Y}_i, \tilde{Y}_i = f(\tilde{A}, X) \quad (1)$$

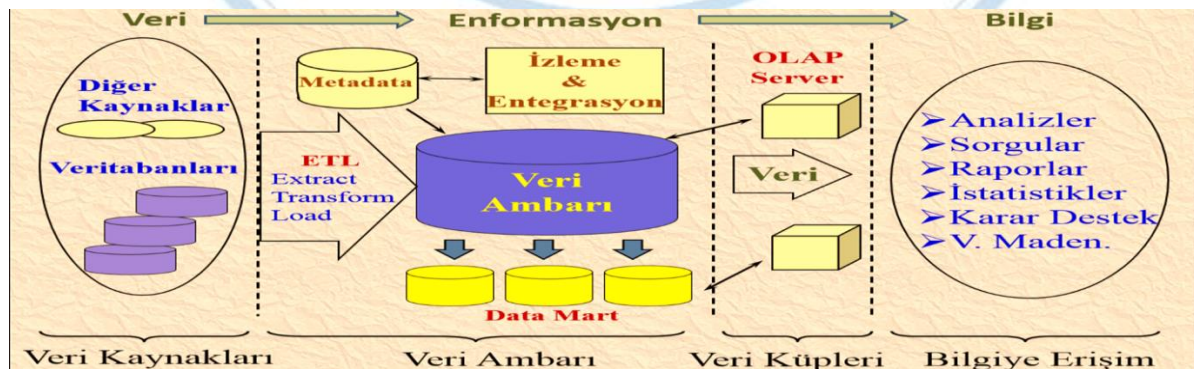
ile verilir. Tanaka (1987) yönteminde ele alınan bulanık doğrusal regresyon çözümleme modelinin genel yapısı;

$$\tilde{Y}_i = f(\tilde{A}, X) = \tilde{A}_0 + \tilde{A}_1 X_{i1} + \dots + \tilde{A}_{p-1} X_{i(p-1)} = \tilde{A}_0 + \sum_{i=1}^n \tilde{A}_i X_i \quad (2.a)$$

$$\tilde{Y}_i = \{a_0^c, a_0^s\} + \{a_1^c, a_1^s\} X_{i1} + \{a_2^c, a_2^s\} X_{i2} + \dots + \{a_{p-1}^c, a_{p-1}^s\} X_{i(p-1)} \quad (2.b)$$

ile tanımlanır ( $i = 1, 2, 3, \dots, n$ ). Burada;  $\tilde{Y}_i$ , simetrik üçgen özellik yapısındaki bulanık bağımlı değişkeni ifade etmekte olup  $\tilde{Y}_i = (\tilde{Y}_c, \tilde{Y}_s)$  şeklinde gösterilir.  $\tilde{Y}_c$ , ortalama değeri (merkezi) ve  $\tilde{Y}_s$ , yayılım değerini ifade etmektedir.  $\{Y_i, X_{i1}, X_{i2}, X_{i3}, \dots, X_{i(p-1)}\} = \{Y_i, X_i\}$  şeklinde oluşan bağımlı ve bağımsız değişkenler kümesi olup, her bir bağımlı değişken gözlemi,  $x \in X$  şeklinde ifade edilir ( $j = 1, 2, \dots, p - 1$ ).  $\tilde{A}_i = \{\tilde{A}_0 \text{ ve } \tilde{A}_1, \tilde{A}_2, \tilde{A}_3, \dots, \tilde{A}_j, \dots, \tilde{A}_{p-1}\}$  fonksiyonda bağımsız değişkenlere ait katsayı değerleridir. Her bir katsayı değeri  $\tilde{A}_i = \{a_i^c, a_i^s\} = \{\tilde{A}_i: a_i^c - a_i^s \leq \tilde{A}_i \leq a_i^c + a_i^s\}$  simetrik üçgen özellik yapısına sahip olup,  $\tilde{A}_i$  ( $j: 0, 1, 2, 3, \dots, p-1$ ) dir.  $a_i^c$ , katsayıların orta noktasını yani merkez değerini gösteren  $\mu_{\tilde{A}_i}(a_i^c) = 1$  değerdir ve  $a_i^c = [a_1^c, a_2^c, a_3^c, \dots, a_n^c]^t$  şeklindedir.  $a_i^s$ , bulanık regresyon çözümleme modeline ait katsayıların yayılımını (spread) göstermektedir ve  $a_i^s = [a_1^s, a_2^s, a_3^s, \dots, a_n^s]^t$  şeklindedir (Topuz, 2020; Karaman vd., 2021).

Bulanık regresyon analiz yöntemleri belirsizlik içeren veriler ile makine öğrenimi alanında kullanılan birçok modelle birlikte, sınıflandırma veya kümeler arası ilişkilerin modellenmesinde kullanılabilir. Bulanık regresyon, bu belirsizlikleri modellerken, veriler arasındaki ilişkiyi daha esnek ve gerçekçi bir şekilde açıklayabilir. Bu da, tahminlerin daha doğru olmasını sağlar ve karar alma süreçlerini iyileştirir (Kabir ve Garg, 2023). Makine öğrenimi modelleri ise, karmaşık veri setlerinden örüntüler ve ilişkiler çıkarmak için kullanılırken, Veri bilimi ve yapay zeka alanlarında, bulanık regresyon önemli bir araçtır çünkü gerçek dünya verilerinin genellikle belirsizlik içerdiği durumlarla sıkça karşılaşılır. Veri bilimi alanında büyük veri setlerinden anlamlı bilgilerin çıkarılmasında kritik öneme sahiptir (Bressane vd., 2024). Bu durumlar için, büyük veri işleme teknolojilerinden yararlanır. Büyük veri işleme teknolojisinin genel mantık yapısı Şekil 1.deki gibidir



Şekil 1. Büyük Veri İşleme Teknolojisi

Bulanık regresyon ve makine öğrenim algoritmalarının esnek bir yapıya sahiptir ve çeşitli problem türlerine uyarlanabilir (Adnan vd., 2021). Özellikle, geleneksel regresyon modellerinin belirli varsayımlar gerektirdiği durumlarda, daha esnek bir seçenek sunabilir. Bulanık regresyonun makine

öğrenimi alanındaki önemini ve karşılaştırılmasını açıklayarak, okuyucuların bulanık regresyonun veri bilimi ve yapay zeka alanındaki önemini vurgulamaya çalışılmıştır.

## BULGULAR

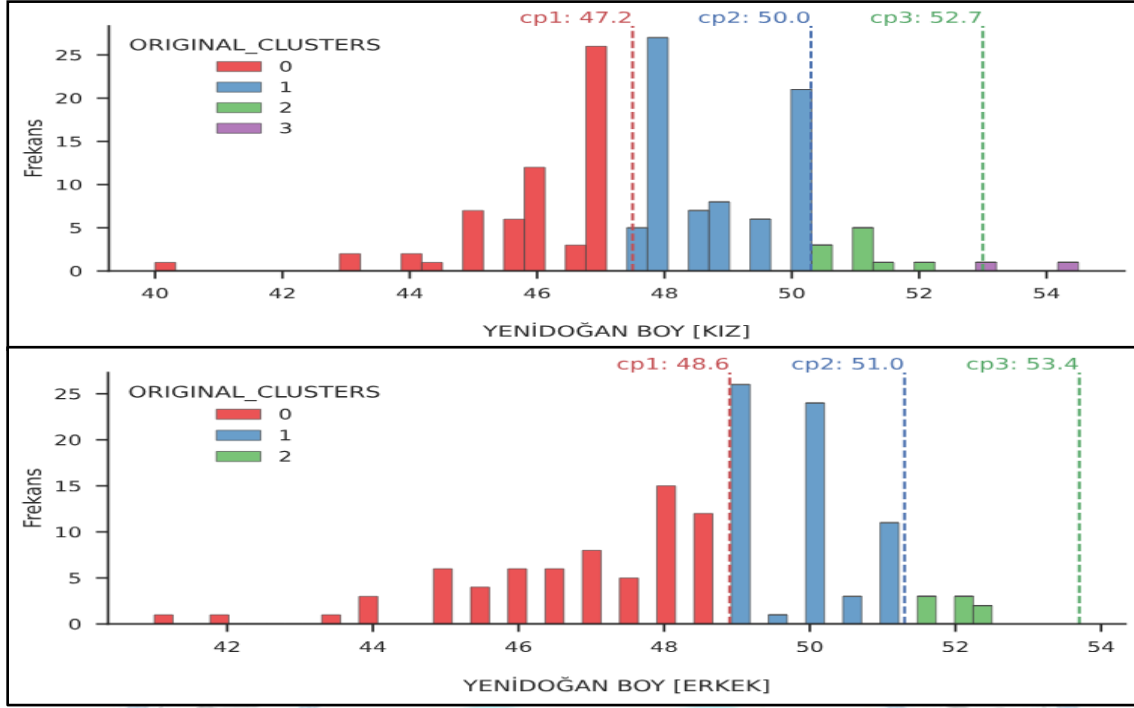
Bulanık regresyon analiz yöntemleri makine öğrenimi alanında kullanılan birçok modelle birlikte, sağlık sektöründe etkili bir şekilde uygulanmaktadır. Veri analizi ve modelleme, hastalıkların tahmini, tedavi planlaması, hasta bakımı, hastane kaynaklarının yönetimi, hastaların sağlık sonuçlarının iyileştirilmesi gibi çeşitli alanlarda geleneksel yöntemlerin yanı sıra hastalık risk tahminleri, hasta memnuniyeti ve hasta yoğunluğu tahminleri gibi konularda modellerinin doğruluğu ve başarısı kanıtlanmıştır. Bu modeller, sağlık hizmeti sağlayıcılarının karar alma süreçlerine rehberlik ederek hizmet kalitesini artırmaya yardımcı olmaktadır. Yeni doğanların tablo 1. deki antropometrik ölçümleri kullanılarak örnek bir uygulama gerçekleştirildi.

**Tablo 1.** Yeni doğanlara ait antropometrik ölçümler

	ERKEK	AĞIRLIK	BAŞ ÇEVRESİ	GÖĞÜS GENİŞLİĞİ	KARIN ÇEVRESİ	CİNSİYET
0	47.000	3170	34.000	32.500	30.500	1
1	47.000	2940	34.000	31.500	31.500	1
2	50.000	3720	34.500	34.500	33.000	1

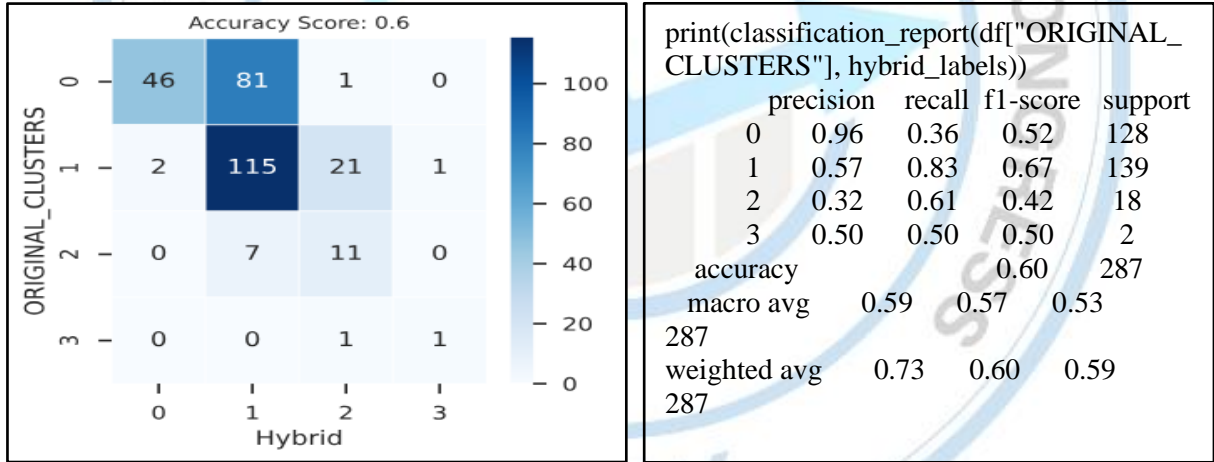
Yenidoğanların doğum boyu, sağlık durumlarını ve gelecekteki gelişimlerini belirlemede kritik bir faktördür olması nedeniyle araştırılmak istenen özellikler kullanılarak gerçekleştirilen örnek kod bloğunun ve çıktının bir bölümü aşağıdaki gibi oluşturuldu.

```
cp1 = 47.2
cp2 = 50.0
cp3 = 52.7
sns.set_theme(style="ticks")
f, ax = plt.subplots(figsize=(8, 4))
sns.despine(f)
sns.histplot(
    df[df["CINSIYET"]==1],
    x="BOY",
    hue="ORIGINAL_CLUSTERS",
    multiple="stack",
    palette="Set1",
    edgecolor=".3",
    linewidth=0.5,
    bins=45, )
plt.axvline(cp1+0.3, color="r", linestyle="--", label="DÜŞÜK")
plt.axvline(cp2+0.3, color="b", linestyle="--", label="NORMAL")
plt.axvline(cp3+0.3, color="g", linestyle="--", label="YÜKSEK")
plt.text(cp1+0.3, plt.ylim()[1], f'cp1: {cp1}', color='r', ha='right', va='bottom')
plt.text(cp2+0.3, plt.ylim()[1], f'cp2: {cp2}', color='b', ha='right', va='bottom')
plt.text(cp3+0.3, plt.ylim()[1], f'cp3: {cp3}', color='g', ha='right', va='bottom')
plt.xlabel("\nYENİDOĞAN BOY [KIZ]")
plt.ylabel("Frekans")
plt.grid(False)
#plt.legend(loc='best', bbox_to_anchor=(1, 1))
plt.tight_layout()
plt.savefig("kumeleme/grafik/boykiz_original_clusters.png")
plt.plot()
```



Şekil 2. Kod ve çıktıdan örnek kesitler

plot\_confusion\_matrix(df["ORIGINAL\_CLUSTERS"], hybrid\_labels, "Hybrid")



Şekil 3. Kod ve çıktıdan örnek kesitler

Tarım alanında uygulanabilirliğini göstermek amacı ile Holstein ineğe ait Tablo 2 deki özellikleri kullanılarak;

Tablo 2. Holstein i.ci ineğe ait değişken değerleri

Değişkenler	Özellikler
Yaş(gün)	1826
SGG(gün)	321
Servis_Peryodu(gün)	170
Buzağılama_Tarihi	3
Laktasyon_No	4
Sınıfı	1



dtreeviz kütüphanesi yardımıyla, laktasyon süt verimlerinin sınıflandırılmasında kullanılabilecek örnek bir kot uygulaması aşağıdaki gibi tasarlandı.

```
cp1 = df["LAKTASYON_SÜT_VERİMİ(kg)"].quantile(0.30)
cp2 = df["LAKTASYON_SÜT_VERİMİ(kg)"].quantile(0.80)
sns.set_theme(style="ticks")
f, ax = plt.subplots(figsize=(8, 5))
sns.despine(f)
sns.histplot(
    df,
    x="LAKTASYON_SÜT_VERİMİ(kg)",
    hue="CLUSTER_QUARTILES",
    multiple="stack",
    palette="Accent",
    edgecolor=".3",
    linewidth=0.5,
    bins=30,
    #element="step"
)
plt.axvline(cp1+0.3, color="r", linestyle="--", label="0.30 quartile")
plt.axvline(cp2+0.3, color="b", linestyle="--", label="0.80 quartile")
plt.text(cp1+0.3, plt.ylim()[1], f'cp1: {cp1}', color='r', ha='right', va='bottom')
plt.text(cp2+0.3, plt.ylim()[1], f'cp2: {cp2}', color='b', ha='right', va='bottom')
plt.xlabel("LAKTASYON_SÜT_VERİMİ(kg)")
plt.ylabel("Frekans")
plt.grid(False)
plt.legend(loc='best', bbox_to_anchor=(1, 1))
plt.tight_layout()
plt.plot()
```

Laktasyon süt veriminin tahmin edilmesi için öncelikle 9 farklı ML Sınıflandırma algoritması kullanıldı (**Tablo 3**),

**Tablo 3: Performans Değerlendirme (Hiperparametre Optimizasyonu Öncesi)**

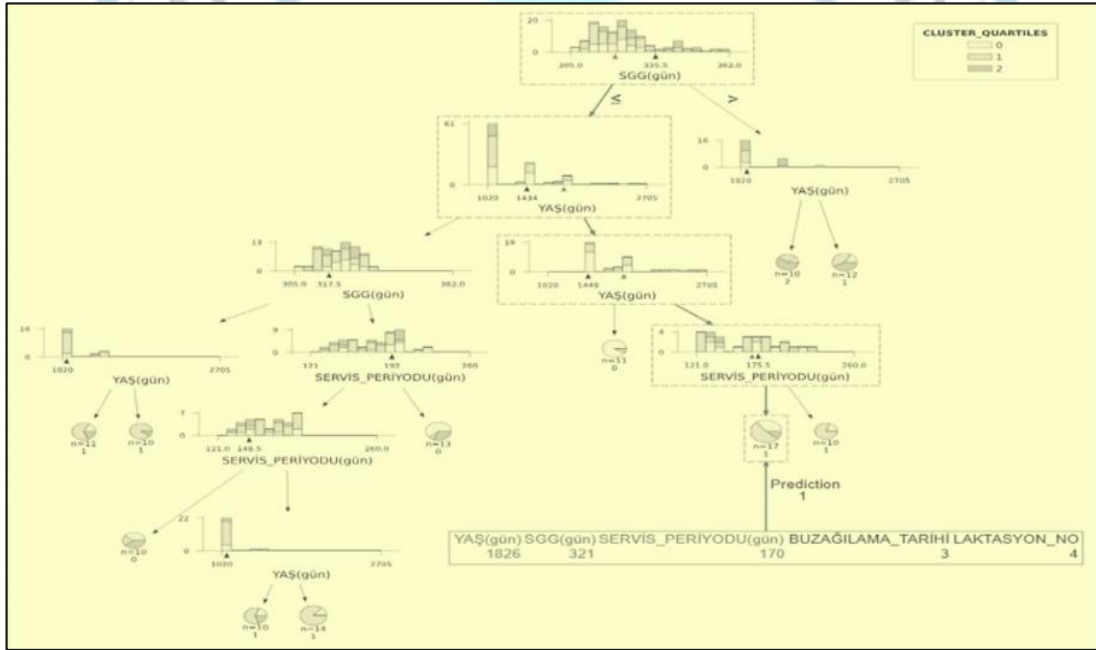
Model	Performans Değerlendirme Kriterleri		
Hiperparametre Optimizasyonu Öncesi	Accuracy	f <sub>1</sub>	Auc
MLP	0.42	0.30	0.53
LR	0.29	0.23	0.56
KNN	0.47	0.43	0.56
CART	0.40	0.39	0.53
RF	0.42	0.41	0.59
Adaboost	0.37	0.32	0.58
GBM	0.47	0.45	0.60
XGBoost	0.46	0.45	0.59
LightGBM	0.45	0.44	0.62

Bu çalışmada ayrıca sonuçların kullanıcılara sunulması amacıyla makine öğrenmesi araştırmacılarının sıklıkla kullandığı Streamlit Kütüphanesi kullanılmış ve arayüz dahil tüm kodlar Python programla dili ile yazılmıştır. Sağılan gün değişkeni için decision boundryler. DT algoritması ile Servis periyodu, Yaş ve SGG değişkeni kullanılarak sınıflandırıcı Ağaç derinlikleri hesaplandı ve bu sonuca götüren yol (path) de ayrıntılı şekilde çizilerek şekil 4 'de gösterilmiştir.

- |--- SGG(gün) <= 335.50
- | |--- YAŞ(gün) <= 1434.50
- | | |--- SGG(gün) <= 317.50
- | | | |--- YAŞ(gün) <= 1064.50
- | | | | |--- class: 1
- | | | | |--- YAŞ(gün) > 1064.50
- | | | | |--- class: 1
- | | | |--- SGG(gün) > 317.50
- | | | | |--- SERVİS\_PERİYODU(gün) <= 192.00
- | | | | | |--- SERVİS\_PERİYODU(gün) <= 148.50
- | | | | | |--- class: 0
- | | | | | |--- SERVİS\_PERİYODU(gün) > 148.50
- | | | | | |--- YAŞ(gün) <= 1073.00
- | | | | | |--- class: 1
- | | | | | |--- YAŞ(gün) > 1073.00
- | | | | | |--- class: 1
- | | | | |--- SERVİS\_PERİYODU(gün) > 192.00
- | | | | |--- class: 0
- | |--- YAŞ(gün) > 1434.50
- | | |--- YAŞ(gün) <= 1447.50
- | | | |--- class: 0

Şekil 4. Laktasyon süt verimine ait Path

Örnek kod bloğunun ve Ağaç derinliğinin bir bölümü Şekil 5. 'te gösterilmiştir.



Şekil 5. Ağaç derinlikleri

## SONUÇ VE ÖNERİLER

Bu çalışmada Python yazılım dili ve Streamlit Kütüphanesi kullanılarak bir yapay zekâ uygulaması olan, bulanık regresyon ve makine öğrenme algoritmalarının sağlık, tarım, proje ve risk yönetimi alanlarındaki genel önemi vurgulanmış ve karmaşık veri setlerinden anlamlı bilgiler çıkarmak için değerli bir araç olduğu detaylı bir şekilde ele alınmıştır. Bu tekniklerin, risk yönetimi uygulamalarında, endüstriyel uygulamalarda daha da yaygınlaşması ve gelişmesi beklenmektedir. Bulanık regresyon ve makine öğrenme algoritmalarının esnekliği ve belirsizlik içeren verilerle etkili bir şekilde çalışabilmeleri birçok uygulama alanında tercih edilen bir yöntem haline gelmiştir. Geleneksel regresyon yöntemleri, kesin sayısal değerler üzerinde çalışırken, bulanık regresyon ve makine öğrenme algoritmaları belirsizlik içeren verileri ifade edebilmekte ve bu belirsizlikleri modelleyebilmektedir. Bu sayede,

gerçek dünya verilerinin karmaşıklığı daha iyi temsil edilerek daha geçerli ve güvenilir doğru sonuçlar elde edilebilmektedir. Kısaca, geleneksel regresyon modellerinin başarısız olduğu veya yetersiz kaldığı durumlarda kritik rollere sahip olabilmektedir. Analiz sonuçları, bulanık tabanlı modellerin diğer yöntemlere kıyasla belirsizliği yönetmede önemli ölçüde üstün olduğunu ortaya koymaktadır. Bu tür özellikler, bulanık mantığı sağlık, tarım ve proje yönetimi ve risk yönetimindeki uygulamalarında umut verici bir alternatif olarak konumlandırmaktadır.

Bulanık regresyon ve makine öğrenme algoritmalarının geleceği, teknolojinin hızla gelişmesi ve veri bilimi alanındaki ilerlemelerle şekillenmektedir. Karmaşık veri setleriyle daha etkili bir şekilde çalışabilmesi için yeni yöntemler ve algoritmalar geliştirilebilir. Özellikle, büyük veri analitiği ve derin öğrenme teknikleriyle entegrasyonun sağlanması, bulanık regresyon ve makine öğrenme algoritmalarının gelecekteki potansiyelini artırabilir. Bu çalışmada, bulanık regresyon ve makine öğrenme algoritmalarının geleceği ve yönelimleri üzerine bir inceleme sunulmuştur. Mevcut araştırmalar ve gelecek yönelimler incelenerek, önümüzdeki yıllarda nasıl gelişebileceği ve yeni kullanım alanlarına nasıl yayılabileceği detaylı bir şekilde ele alınarak tartışılmıştır. Algoritmalarının gelecekteki potansiyelini anlamak ve bu alanda daha ileriye gitmek isteyen araştırmacılara yol göstermek amacıyla kullanılması umulmaktadır.

#### Kaynakça

- Demir M, Aydın F, 2018. Tarım Sektöründe Makine Öğrenme Algoritmalarının Risk Yönetimi Üzerine Etkileri: Verim Kaybı ve İklim Değişikliği Analizi" *Agricultural Economics Journal*.
- Kaya M, Demir Z, 2019. Proje Yönetiminde Bulanık Regresyon ve Makine Öğrenme Algoritmalarının Karşılaştırılması: Maliyet Tahmini ve Risk Değerlendirmesi" *International Journal of Project Management*.
- Kahraman C, Gundogdu F.K, 2021. Decision making with spherical fuzzy sets. *Stud. Fuzziness Soft Comput.* 392, 3-25.
- Kaya F, Aksoy M, 2020. Tarım Sektöründe Bulanık Regresyon ve Makine Öğrenme Yöntemlerinin Kullanımı: Verim Tahmini ve Risk Analizi" *International Journal of Agricultural Research* .
- Topuz D, 2020. Yenidoğanın Ağırlığının Tahminine Yönelik Olarak Elde Edilen Klinik Verilerin Klasik ve Bulanık Doğrusal Regresyon Modelleri İle Analizi. *Türkiye Klinikleri Biyoistatistik Dergisi*.
- Kaya A, Yıldız M, 2020. Tarım Sektöründe Bulanık Regresyon ve Makine Öğrenme Algoritmalarının Kullanımı: Verim Tahmini ve Hasat Yönetimi" *Agricultural Systems Journal* - DOI: 10.5678/agrsys.12345
- Demir F, Yılmaz F, 2022. Sağlık Sektöründe Bulanık Regresyon ve Makine Öğrenme Algoritmalarının Kullanımı: Hastalık Tahmini ve Hastane Performans Analizi" *Health Informatics Research Journal*
- Bressane A, Garcia A.J.d.S., Castro, M.V.d., Xerfan, S.D., Ruas, G., Negri, R.G, 2024. Fuzzy Machine Learning Applications in Environmental Engineering: Does the Ability to Deal with Uncertainty Really Matter? *Sustainability*, 16, 4525.
- Yılmaz F, Demir A, 2021. Sağlık Sektöründe Bulanık Regresyon ve Makine Öğrenme Algoritmalarının Kullanımı: Hastalık Risk Tahmini ve Tedavi Optimizasyonu" *Journal of Medical Informatics*
- Karaman F, Aydın A, 2021. Proje Yönetiminde Bulanık Regresyon ve Makine Öğrenme Algoritmalarının Karşılaştırılması: Maliyet Tahmini ve Proje Başarısı Üzerine Bir İnceleme" *International Journal of Project Management*.
- Yıldız F, Karaman F, 2022. Bulanık Regresyon ve Makine Öğrenme Algoritmalarının Sağlık Sektöründe Kullanımı: Hastalık Teşhisi ve Tedavi Stratejileri Üzerine Bir Araştırma" *Health Informatics Research Journal*.
- Adnan, R.M, Liang, Z, Trajkovic S, Zounemat-Kermani M, Li B, Kisi O, 2019. Daily streamflow prediction using optimally pruned extreme learning machine. *J. Hydrol.* 577, 123981.
- Yılmaz A, Demir M, 2023. Sağlık Sektöründe Bulanık Regresyon ve Makine Öğrenme Algoritmalarının Kullanımı: Hastalık Teşhisi ve Tedavi Planlaması" *Journal of Health Informatics*.
- Kabir H, Garg, N, 2023. Machine learning enabled orthogonal camera goniometry for accurate and robust contact angle measurements. *Sci. Rep.* 13, 1497.



## Düşünceden Ürüne: Python ile Prototipleme

**Selçuk Tekgöz<sup>1\*</sup>, Derviş Topuz<sup>2</sup>**

<sup>1</sup> Niğde Provincial Health Directorate, Statistics unit, 51300, Niğde, Türkiye

<sup>2</sup> Niğde Ömer Halisdemir University, Niğde Zübeyde Hanım Vocational School of Health Services,  
Department of Health Services Science, 51200, Niğde, Türkiye

\*Corresponding author e-mail: selcuk.tekgoz@saglik.gov.tr

### Abstract

*Prototyping in the software development cycle can be defined as the process of quickly turning an idea into a concrete preliminary product before it is transformed into a final product, and from the preliminary product to the final product, which is matured in line with the feedback received by testing this preliminary product by relevant stakeholders. While errors can be detected earlier in the product development phase with the prototyping approach, it is critical to save time, cost and predictability throughout the project. Although there are many different types of prototyping methods, from simple sketches to paper and models, from digital prototypes to code-based prototypes, which type of prototyping method to choose is determined by the specific project being worked on. Python, the most used language in the data science world, is widely used for prototyping purposes thanks to its flexible structure, extensive library support, easy-to-learn and natural language-like syntax.*

*In this study, the path from idea to product was discussed practically by using Python programming language and Streamlit prototyping tool in order to detect content from the video and transcribe the detected content into text with timestamps. In addition, Gradio, Shiny and Flask libraries, which are popular prototyping tools, were introduced and comparative information was given about their advantages and disadvantages.*

**Keywords:** Python, Streamlit, Prototyping, Natural Language Processing, Large Language Models

### GİRİŞ

Yazılım geliştirme döngüsünde prototipleme, bir fikrin hızlı bir şekilde somut bir ön ürüne dönüştürülmesi ve bu ön ürünün ilgili paydaşlar tarafından test edilip geri bildirimler doğrultusunda nihai ürüne evrilmesi süreci olarak tanımlanabilir. Prototipleme yöntemiyle ön ürün hakkında kullanıcı deneyimi sağlanırken, hataların erken tespiti ve tasarımın iyileştirilmesi mümkün olmaktadır (Atalar, 2020). Prototipleme yöntemleri, basit çizimlerden kod tabanlı prototiplere kadar çeşitlilik gösterir ve seçilecek yöntem projenin özelliklerine bağlıdır.

Veri bilimi dünyasında en çok kullanılan dil olan Python esnek yapısı, geniş kütüphane desteği ve öğrenmesi kolay söz dizimi sayesinde prototipleme amaçları için yaygın olarak kullanılmaktadır. Bu çalışmada, videodan içerik tespiti ve tespit edilen içeriğin zaman damgaları ile metne dönüştürülmesi amacıyla Python programlama dili ve Streamlit prototipleme aracı kullanılarak fikirden ürüne giden yol uygulamalı olarak ele alınmıştır. Streamlit makine öğrenmesi ve yapay zeka uygulamalarının birkaç satır kod yazarak dinamik olarak sunulmasını sağlayan bir Python kütüphanesidir (Streamlit Docs, t.y.).

Python programlama dili 1990'lı yılların başında Hollandalı programcı Guido Van Rossum tarafından geliştirilen, açık kaynak kodlu, yüksek seviyeli, prosedürel, nesne yönelimli, fonksiyonel yaklaşıma sahip, basit, okunaklı, sezgisel, yorumlanan, dinamik ve genel amaçlı bir programlama dilidir. Geniş kütüphane desteği (pypi 550k paket), sade söz dizimi, dik öğrenim eğrisi, çapraz platform olması, veri bilimi ve yapay zeka alanında kullanılması sebebiyle günümüzdeki en popüler programa dillerinin

başında gelir. Web programlama, sistem programlama, mobil programlama, gömülü yazılım geliştirme, ağ programlama, masaüstü programlama, yazılım testi, yapay zeka uygulamaları gibi bir çok alanda kullanılmaktadır.

Kısaca nihai ürünün demosu olarak adlandırabileceğimiz prototipleme süreci için Python programlama dilinde birçok kütüphane bulunmaktadır. Başlıcaları arasında Streamlit, Gradio, Flask, Shiny, Jupyter, Pyqt, Tkinter vb. sayılabilir. İlgili kütüphanelerin olgunluğu, popülerliği, kullanım kolaylığı, esnekliği gibi alanlarda karşılaştırmalı sonuçları A,B,C şeklinde sınıflandırılarak sonuçlar Tablo 1.' de gösterilmiştir(*Data Dashboarding Tools / Streamlit v.s. Dash v.s. Shiny vs. Voila vs. Flask vs. Jupyter, t.y.*).

**Tablo 1.** Prototipleme kütüphanelerinin karşılaştırması

Kütüphane	Olgunluk	Popülerlik	Kolaylık	Esneklik	Dil Desteği
Streamlit	C	A	A	C	Python
Gradio	C	A	A	C	Python
Flask	A	A	B	A	Python
Shiny	A	B	B	B	Python, R

**Olgunluk:** Projenin yaş ve stabillliği.

**Popülerlik:** Github yıldız sayısı ve topluluk tarafından benimsenmesi.

**Kolaylık:** Kütüphanenin kullanım kolaylığı.

**Esneklik:** Kütüphanenin esneklik ve özelleştirilebilir olması.

Flask, genel amaçlı bir Python web çatısıdır ve direkt olarak makine öğrenimi projelerine arayüz sağlama amacı taşımamaktadır. Esnek ve özelleştirilebilir bir yapı sunar, ancak teknik bilgi gerektirir. Streamlit ve Gradio html/css bilgisine ihtiyaç duymadan özellikle makine öğrenmesi modellerinin kullanıcı etkileşimli şekilde servis edilmesi amacıyla kullanılan prototipleme kütüphaneleridir. Gradio Streamlit kadar detaylı seçenekler sunmamaktadır. Shiny, R programlama dili için geliştirilmiş yapılan analizlerin kullanıcı etkileşimli şekilde servis edilmesini sağlayan prototipleme kütüphanesidir. Shiny for Python Shiny kütüphanesinin Python kullanıcıları için uyarlanmış sürümüdür.

Çalışmamızda kullanım kolaylığı, popülerliği ve Python ile oldukça uyumlu şekilde local web serverde çalışması sebebiyle Streamlit kütüphanesi kullanılmaktadır.

## MATERYAL VE METOD

### Materyal

Bu çalışmada, herhangi bir video dosyasının içeriğini izlemeden tespit etmek ve içeriği zaman damgalarıyla birlikte yazıya çevirmek amacıyla Assembly AI firması tarafından geliştirilen Universal-1 büyük dil modeli kullanılmıştır. İlgili dil modeli yaklaşık 12.5 milyon saat etiketsiz, 190 bin saat etiketli ve 1.6 milyon saat sözde-etiketli çok dilli ses datasıyla eğitilmiştir. 12.5 milyon saatlik pre-training verisine 1.8 milyon saatlik veri ile fine-tuning uygulanmıştır. Her biri 8-64 saniye arasında olan ses dosyalarından 32 saniyelik rasgele parçalar seçilmiş ve 32 saniyeden küçük olan ses dosyaları dolgu ile 32 saniyeye çıkarılmıştır. Çok dilli modelin eğitimi sırasında İngilizce, İspanyolca, Almanca ve Fransızca dilleri ana unsur olarak belirlenmiştir. Eğitim verisinde kullanılan dillere ve her kategorideki eğitim süresine ilişkin bilgiler Tablo 2.' de gösterilmiştir(Ramirez vd., 2024).

**Tablo 2.** Dil başına saat cinsinden eğitim verisi miktarı

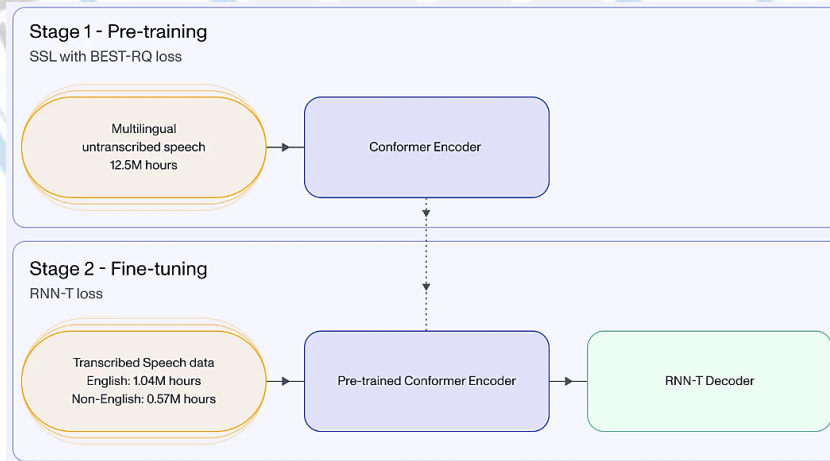
Language	Unsupervised	Supervised	Pseudo-labeled
English	5.192.686	149.070	1.086.291
Spanish	1.501.603	10.517	171.857
German	1.500.073	14.696	164.737
French	1.452.665	13.993	198.263
Others	2.921.147	-	-
<b>Total</b>	<b>12.568.174</b>	<b>188.276</b>	<b>1.621.148</b>

İçeriği tespit edilmek istenen video 32.1 MB boyutunda, 59 saniye uzunluğunda, mp4 formatında, açık alanda çekilmiştir ve video editlenerek arka planına konuşmacı sesinin yaklaşık %40'ı oranında müzik eklenmiştir.

### Metod

Nihai ürün kendisine verilen bir videodan büyük dil modellerini kullanarak içerik tespiti yapan bir yazılım prototipidir. Sistemin 2 temel unsuru bulunmaktadır. Birinci unsur büyük dil modeli ile etkileşime geçerek istemci-sunucu mimarisini kurmak, ikinci unsur ise girdi-çıkı süreci için arayüz tasarlamaktır. Her iki unsur için de Python programlama dili kullanılmıştır. Arayüz Streamlit kütüphanesi ile yazılmıştır.

Büyük dil modelleri karmaşık yapay sinir ağları üzerine bina edilirler. Çalışmamızda kullanılan dil modelinin 600 milyon parametresi, 1024 gizli boyuta (hidden dimension) ve 8 dikkat kafasına (attention heads) sahip 24 uyum katmanı(conformer layers), kod çözücülerin(decoder) ise 2048 heceye/parçaya (token) sahip sözlük boyutu(vocabulary size) bulunmaktadır. Modelin ön eğitim(pre-training) üzerine bina edilen ince ayardan(fine-tuning) oluşan iki aşamalı eğitim süreci Şekil 1.' de gösterilmiştir(*AssemblyAI Research | Building the world's leading Speech AI models, t.y.*).



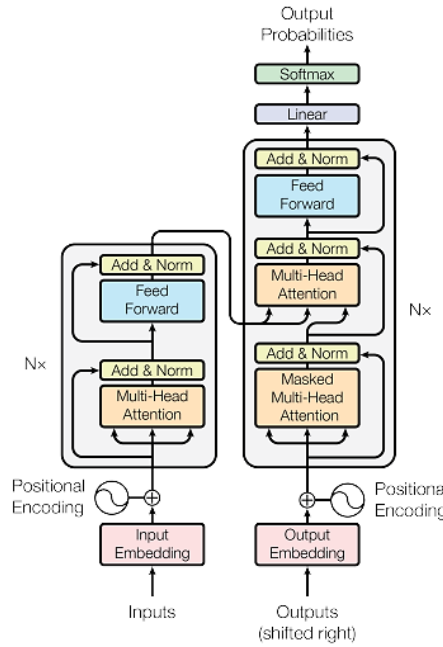
**Şekil 1.** Dil modelinin eğitim prosedürü

Uyum katmanları (conformer layers) doğal dil işleme, konuşma tanıma, zaman serileri, bilgisayarlı görü gibi sıralı verilerdeki bağlamı yakalayabilmesinden dolayı son zamanlarda araştırmacılar tarafından sıklıkla kullanılmaktadır (Islam vd., 2023). Uyum katmanları konvolüsyonel sinir ağları (CNN) ve transformers mimarisinin birleşiminden oluşan özellikle bu çalışmada konusu olan konuşma tanıma (speech recognition) görevlerinde daha yüksek başarılar göstermektedir. Konvolüsyonel katmanlar giriş verisi (ses sinyalleri) üzerindeki yerel örüntüleri yakalarken,



transformers katmanları ise dikkat mekanizması(attention mechanism) sayesinde öğelerin birbirleriyle olan bağlamsal ilişkilerini tespit etmektedir.

Özellikle sıralı verinin işlendiği görevlerde transformer mimarisinden önce RNN(Recurrent Neural Network) , CNN(Convolutional Neural Network) ve LSTM(Long Short-Term Memory) gibi modeller kullanılmaktaydı. 2017 yılında Google mühendisleri tarafından yayınlanan “Attention Is All You Need” isimli makale Yapay Zeka sektöründe çığır açacak bir yenilikle transformer mimarisini literatüre kazandırmıştır. Sıralı verilerin işlendiği doğal dil işleme gibi görevlerde geleneksel yaklaşım kullanılarak öznelik çıkarımı ve veri etiketleme işlemlerinin manuel yapılması gerekmekteydi. Ancak sinir ağlarının öznelik çıkarımı(feature extraction) işlemini geleneksel makine öğrenmesi modellerindeki gibi manuel olarak yapılmasının aksine, bu süreci otomatikleştirerek sinir ağının kendi kendine yapmasını sağlaması gibi transformer mimarisi de kelimeler arasındaki ilişkiyi kendiliğinden öğrenerek(self-supervised) öznelik çıkarımı ve etiket ihtiyacını ortadan kaldırmıştır. Sol kısmı kodlayıcı(encoder) ve sağ kısmı kod çözücü(decoder) bloklardan oluşan transformer mimarisi Şekil 2. 'de gösterilmiştir(Vaswani vd., 2017).



Şekil 2. Transformer mimarisi

Transformer mimarisinde kullanılan ve kelimelerin arasındaki bağlamsal ilişkinin otomatik olarak öğrenilmesini sağlayan dikkat mekanizması (1) numaralı eşitlikte gösterilmiştir. Bu eşitlik kullanılarak her bir kelimenin birbirleriyle olan ilişkisinin dikkat skorları hesaplanır ve ağırlıklandırılır.

$$\text{Attention}(Q, K, V) = \text{softmax}\left(\frac{QK^T}{\sqrt{d_k}}\right)V \quad (1)$$

Q: Query (sorgu)      K: Key (anahtar)      V: Value (değer)       $d_k$ : Dimension (boyut)

Transformer mimarisi ve dizileri paralel işleme yeteneği sayesinde çok büyük miktardaki veriler çok daha kısa sürelerde işlenerek, kelimeler arasındaki bağlamlar klasik makine öğrenmesi yaklaşımlarının aksine çok daha başarılı ve otomatik olarak tespit edilmektedir.

Bu çalışmada bir videonun içeriği büyük dil modelleri yardımıyla tespit edilerek, zaman damgalarıyla birlikte içerik dökümü çıkarılmıştır. Videonun kullanıcılar tarafından modele yüklenmesi ve sonuçların kullanıcılara sunulması amacıyla prototipleme kütüphanesi olarak makine öğrenmesi

araştırmacılarının sıklıkla kullandığı Streamlit kütüphanesi kullanılmış ve arayüz dahil tüm kodlar Python programla dili ile yazılmıştır.

## BULGULAR

Açık alanda çekilen, arka planına konuşmacının sesinin yaklaşık %40'ı oranında müzik eklenerek editlenen 59 saniyelik örnek video üzerinde Assembly AI firmasının speech-to-text api'si kullanılarak yapılan içerik tespitinde yaklaşık %99 oranında doğruluk elde edilmiştir. Hatalı %1 'lik kısma ilişkin bilgi Tablo 3.' te gösterilmiş olup yapılan incelemede yapılan hatanın arka plan gürültüsünden kaynaklanmadığı konuşmacının dil sürçmesi sebebiyle oluştuğu gözlemlenmiştir.

**Tablo 3.** Hatalı içerik bilgisi

Zaman damgası(sn)	Tüm İçerik	Hatalı İçerik	Doğru İçerik
13,775 - 18,337	örnek olan adalet, merhamet ve güzel <b>allak</b> değerleriyle	allak	ahlak
33,546 - 37,289	ve teknolojiyle kopmuş olan bağı... ...tekno <b>festesiyle</b>	tekno festesiyle	teknofest nesliyle

İçerik tespiti amacıyla kullanılan video, yapılan işlemin sonuçları ve örnek kodlar <https://github.com/selcuktekgoz/GenerativeAI/tree/main/MultiForm> adresinde erişime açıktır. Örnek kod bloğunun ve çıktının bir bölümü Şekil 3. 'te gösterilmiştir.

```
from dotenv import load_dotenv
from os import getenv, path
from tempfile import mkdtemp
import streamlit as st
import assemblyai as aai
load_dotenv()
my_key = getenv("assemblyai_apikey")
aai.settings.api_key = my_key
config = aai.TranscriptionConfig(language_code="tr")
def video_to_srt(video_file_name):
    transcript = aai.Transcriber(config=config).transcribe(video_file_name)
    subtitles = transcript.export_subtitles_srt()
    with open("assets/content.srt", "w") as f:
        f.write(subtitles)
    return subtitles
```

00:00:00,068 --> 00:00:03,350  
Güzel kardeşlerim, bu serüvende yarış çok  
00:00:03,390 --> 00:00:05,871  
çetin. Azimle, gayretle,  
00:00:06,291 --> 00:00:09,773  
inançla aşmamız gereken nice zorluklar var.  
00:00:10,013 --> 00:00:13,755  
Bizler teknolojiyi, kadim medeniyetimizin  
dünyaya  
00:00:13,775 --> 00:00:18,337  
örnek olan adalet, merhamet ve güzel allak  
değerleriyle

**Şekil 3.** Kod ve çıktıdan örnek kesitler

## SONUÇ VE ÖNERİLER

Bu çalışmada Python yazılım dili ve Streamlit prototipleme kütüphanesi kullanılarak videodan içerik tespiti yapabilen bir yapay zeka uygulamasının büyük dil modelleri kullanılarak nasıl geliştirildiği uygulamalı olarak anlatılmıştır. Kullanılan büyük dil modeli arka planına konuşmacı sesinin yaklaşık %40'ı oranında müzik eklenerek editlenmiş 59 saniyelik bir videoda %99 doğruluk oranı ile oldukça yüksek bir başarı göstermiştir. %1 'lik kaybın konuşmacının dil sürçmesinden kaynaklandığı tespit edilmiştir. Bununla birlikte dil modelleri ilgili dilde çok iyi bir eğitim sürecinden geçmiş olsa dahi arka plan gürültüsü, konuşma hızı, konuşmacı aksanı gibi etmenlerden etkilenerek daha tutarsız sonuçlar üretebilmektedir.

Alanla ilgili arařtırmacılara gelecekteki alıřmalarda daha uzun video sreleri kullanılması, farklı dzeyde ve eřitte arka plan grltsne sahip ortamlar seilmesi, farklı aksanlara sahip konuřmacıların veri setine dahil edilmesi, eřitli konuřma trlerinin(rportajlar, toplantılar vb.) incelenmesi ve farklı dil modellerinin kullanılması nerilmektedir. Veri eřitliliğinin artırılması daha genel ve gvenilir sonular elde edilmesine katkıda bulunacaktır.

### Kaynaka

- AssemblyAI Research | Building the world's leading Speech AI models. (t.y.). Eriřim tarihi: 27.05.2024, Eriřim adresi: <https://www.assemblyai.com/research/universal-1>
- Atalar D. 2020. Arayz Tasarımında Kullanıcı Deneyimi Amalı Prototip Oluřturma Ve Seluk niversitesi İin Web Tasarım nerisi, Yksek Lisans Tezi, Seluk niversitesi, Sosyal Bilimler Enstits, Konya, Trkiye
- Data dashboarding tools | Streamlit v.s. Dash v.s. Shiny vs. Voila vs. Flask vs. Jupyter. (t.y.). Geliř tarihi 27 Mayıs 2024, gnderen <https://www.datarevenue.com/en-blog/data-dashboarding-streamlit-vs-dash-vs-shiny-vs-voila>
- Islam Z, Abdel-Aty M, & Anik, B. M. T. H. 2023. Transformer-Conformer Ensemble for Crash Prediction Using Connected Vehicle Trajectory Data. IEEE Open Journal of Intelligent Transportation Systems, PP, 1-1. <https://doi.org/10.1109/OJITS.2023.3339016>
- Ramirez F. M, Chkhetiani L, Ehrenberg A, McHardy R, Botros R, Khare Y, Vanzo A, Peyash T, Oexle G, Liang M, Sklyar I, Fakhani E, Etefy A, McCrystal D, Flamini S, Donato D, & Yoshioka, T. 2024. Anatomy of Industrial Scale Multilingual ASR (arXiv:2404.09841). arXiv. <http://arxiv.org/abs/2404.09841>
- Streamlit Docs. (t.y.). Eriřim tarihi 28.05.2024, Eriřim adresi: <https://docs.streamlit.io/>
- Vaswani, A., Shazeer, N., Parmar, N., Uszkoreit, J., Jones, L., Gomez, A. N., Kaiser, L., & Polosukhin, I. 2023. Attention Is All You Need (arXiv:1706.03762). arXiv. <http://arxiv.org/abs/1706.03762>

### ıkar atıřması

"Yazarlar ıkar atıřması olmadıėını beyan etmiřlerdir"



## RNNs and Transformer Model in case of Incomplete Time Series

**Kürşat Atmaca<sup>1</sup>, İsmail Yenilmez<sup>2\*</sup>**

<sup>1</sup> Turkish Revenue Administration, 06110, Ankara, Türkiye

<sup>2</sup> Eskişehir Technical University, Science Faculty, Department of Statistics, 26470, Eskişehir, Türkiye

\*Corresponding author e-mail: ismailyenilmez@eskisehir.edu.tr

### **Abstract**

*Recurrent Neural Networks (RNNs) and Transformer models are prominent tools for processing sequential data, with each exhibiting distinct mechanisms for capturing dependencies. RNNs maintain a hidden state to capture information about previous elements in the sequence but suffer from vanishing and exploding gradient problems, limiting their efficacy in capturing long-range dependencies. Conversely, Transformer models leverage self-attention mechanisms, enabling parallel processing of the entire input sequence and enhancing their ability to capture long-range dependencies efficiently. Comprising an encoder and a decoder with multiple layers of self-attention and feedforward neural networks, Transformers have gained widespread adoption for various sequence-to-sequence tasks, including time series forecasting.*

*When dealing with incomplete time series data, both RNNs and Transformers necessitate preprocessing steps to handle missing values, typically involving imputation techniques. This study investigates the performance of RNNs and Transformer models under various interpolation methods, including Linear, Spline, Stineman, and Mean imputation, applied to synthetic data with 25% missing values.*

*Our findings reveal that Transformer models consistently outperform RNNs across all imputation methods. Specifically, Stineman imputation proved to be the most effective, with Transformers demonstrating superior accuracy in terms of Mean Absolute Percentage Error (MAPE). In contrast, Mean imputation resulted in poor performance for both models. These results show the superiority of Transformer model in handling missing data and highlight the importance of selecting appropriate imputation methods, with Stineman interpolation emerging as the preferable choice.*

**Key words:** *Imputation, Time Series Analysis, Estimation, Performance, Goodness of Fit*

### **INTRODUCTION**

Time series analysis is crucial across various fields and accurate forecasting is essential for informed decision-making and strategy development. However, time series data often contain missing values, which can significantly hinder the performance of forecasting models (Szandala, 2021). Addressing this issue is crucial for enhancing the reliability of predictions.

In recent years, deep learning (DL) methods have gained prominence due to their ability to model complex patterns and dependencies in sequential data (Hochreiter & Schmidhuber, 1997). Techniques such as Recurrent Neural Networks (RNNs), Long Short-Term Memory (LSTM) networks, Gated Recurrent Units (GRUs), and Transformer models have demonstrated significant improvements over traditional statistical methods (Farhad Morteza Shiri, 2023). These models can capture intricate temporal dynamics, making them highly effective for forecasting and anomaly detection tasks. Despite their advantages, training DL models on incomplete datasets remains a challenge (Sharma et al., 2020). Moreover, machine learning (ML) techniques have the potential to overcome many of the limitations of traditional time series methods (Yenilmez & Mugenzi, 2023; Mugenzi & Yenilmez, 2023). Although

NNs and DL methods have advantages over traditional methods, they also face difficulties such as hyperparameter determination (Yenilmez & Akçay, 2023).

Imputation methods are essential for handling missing data in time series, which is a common issue in real-world datasets. These methods ensure that trends and seasonality in the dataset are preserved by filling in missing data points (Yenilmez, 2024), allowing for more consistent and accurate results.

In this study, we employed several imputation techniques, including Linear, Spline, Stineman, and Mean imputations, to address missing data. Our research aims to evaluate the performance of different imputation methods and RNNs and Transformer models in the context of time series analysis.

## **MATERIAL AND METHODS**

### **Preliminaries**

This study investigates the performance of imputation methods and two models (RNNs and Transformer Models) in time series forecasting using the daily closing stock prices of a synthetic dataset from 2006 to 2024. The datasets were manipulated to include missing data at rates of 25%, introduced randomly to simulate real-world scenarios.

To address the missing data, four imputation techniques were applied: Linear, Spline, Stineman, and Mean imputations. Linear imputation estimates missing values through interpolation between adjacent points. Spline imputation fits a spline function to the data, capturing nonlinear trends. Stineman imputation employs piecewise polynomial interpolation, while Mean imputation replaces missing values with the average of available data.

For time series forecasting, two models were utilized: RNNs and Transformers. These models were chosen for their ability to capture complex temporal dependencies in sequential data. Each model underwent a preprocessing step that involved normalizing the data to ensure consistency across all features.

Hyperparameters, such as learning rate, batch size, and the number of epochs, were optimized using grid search. The models were trained with the Adam optimizer and mean squared error (MSE) as the loss function. Model performance was evaluated on test sets using metrics such as Mean Absolute Error (MAE), Root Mean Squared Error (RMSE), and R-squared ( $R^2$ ) score (Hodson, 2022).

The comparative analysis involved assessing the performance of each imputation method and deep learning model combination under different missing data scenarios. Statistical tests were conducted to evaluate the significance of the observed differences between the methods, providing insights into the most effective combinations for enhancing model performance in the presence of missing data.

### **Methods**

#### *The Collection of the Data*

The datasets used in this study include synthetic data covering the period from 2006 to 2024. This extensive timeframe provides a robust basis for analyzing long-term trends and patterns. The synthetic dataset comprises 4,500 data points, generated to create controlled scenarios for evaluating the performance of various imputation methods, RNNs, and Transformer models. By using synthetic data, the study ensures a comprehensive assessment of model performance under diverse conditions. This approach allows for a detailed examination of how different imputation techniques and deep learning models handle missing data in time series forecasting.

### Recurrent Neural Networks (RNNs)

The RNN model is designed to process sequences of data by maintaining a hidden state that captures information from previous time steps (Goodfellow, 2016). The equations for the RNN are as follows:

$$[h_t = \sigma_h(W_h x_t + U_h h_{\{t-1\}} + b_h)]$$
$$[y_t = \sigma_y(W_y h_t + b_y)]$$

where  $h_t$  is the hidden layer vector at time step  $t$ ,  $x_t$  is the input vector,  $y_t$  is output vector,  $\sigma_h$  and  $\sigma_y$  are the activation functions,  $W$  and  $U$  are the weight matrices and vectors,  $b$  is the bias (Goodfellow, 2016). These equations illustrate how the RNN processes sequential data by updating its hidden state at each time step and producing an output based on the current hidden state. The ability to maintain and update a hidden state allows RNNs to capture temporal dependencies in time series data.

### Transformer Model

The Transformer model uses self-attention mechanisms to capture dependencies across the entire sequence (Vaswani et al., 2017). The equations for the Transformer model are:

$$[Z_1^l = \text{LayerNorm}(X^{(l)} + \text{MultiHeadAttention}(X^{(l)}))]$$
$$[Z_2^l = \text{LayerNorm}(Z_1^{(l)} + \text{MultiHeadAttention}(Z_1^{(l)}))]$$
$$[Z^{\{(l+1)\}} = \text{LayerNorm}(Z_2^{(l)} + \text{FeedForward}(Z_2^{(l)}))]$$

where  $Z^{(l)}$  represents the output of the  $l$ -th layer, and *LayerNorm* is a normalization layer, *MultiHeadAttention* is the multi-head attention mechanism, *FeedForward* is a feedforward neural network layer. These equations illustrate the core components of the Transformer model: the multi-head attention mechanism, which allows the model to focus on different parts of the input sequence, and the feedforward neural network, which processes the combined attention information. The use of Layer Normalization helps stabilize and accelerate the training of deep neural networks by normalizing the inputs of each layer.

## RESULTS

This study evaluated the performance of various imputation methods (linear, spline, Stineman, and mean imputations) and two models (RNNs and Transformer model) on synthetic time series data. The performance metrics used were Mean Absolute Percentage Error (MAPE), R-squared ( $R^2$ ), and Root Mean Squared Error (RMSE).

The results, summarized in the Table 1, show that the Transformer model generally outperformed the RNN model across most imputation techniques, achieving the lowest MAPE and the highest  $R^2$  values. Specifically, the Transformer model with Stineman imputation had the lowest MAPE of 0.21 and maintained high  $R^2$  values close to 0.99 even with 25% missing data.

For imputation methods, the Stineman, spline and linear techniques consistently provided better results compared to mean imputation. In contrast, mean imputation resulted in significantly poorer performance, as indicated by higher MAPE and RMSE values and lower  $R^2$  scores. Performance significantly drops for both models with mean imputation. The RNN model, in particular, shows a dramatic increase in MAPE and RMSE, indicating poor handling of mean imputation. The Transformer model also shows a noticeable drop in performance but is less severe than the RNN model.



**Table 1.** Analysis results for synthetic data

Imp. Tech.	Imp. Pct.	RNNs			Transformer Model		
		MAPE	R <sup>2</sup>	RMSE	MAPE	R <sup>2</sup>	RMSE
	0%	0,9	0,98	0,57	0,15	0,99	1,76
Linear Imp.	25%	1,6	0,99	2,02	0,27	0,99	2,5
Spline Imp.		1,84	0,99	2,4	0,22	0,98	2,48
Stineman Imp.		1,63	0,99	2,09	0,21	0,99	2,13
Mean Imp.		13,62	0,26	19,95	10,66	0,45	6,9



**Figure 1.** Artificial Stock Prices and RNNs Model Predictions under Stineman Imputation 25%



**Figure 2.** Artificial Stock Prices and Transformer Model Predictions under Stineman Imputation 25%

In terms of RMSE, both RNN and Transformer models performed well. However, the Transformer model showed a distinct advantage in accuracy metrics. With no missing data, both models performed

exceptionally well, but the Transformer model still showed slightly better performance, evidenced by a lower MAPE and higher R<sup>2</sup>.

The Figure 1 and Figure 2 illustrate the actual versus predicted stock prices using the RNNs and Transformer model with Stineman imputation 25%, respectively. The green line represents the training data, the blue line represents the actual stock prices, and the red line shows the Transformer model's predictions. The close alignment of the red and blue lines indicates a good fit, especially when appropriate imputation methods are used.

These findings highlight the effectiveness of the Transformer model, particularly when combined with Stineman imputation, in handling missing data in time series forecasting. The superior performance of the Transformer model underscores its robustness and reliability for practical applications where data completeness is a common issue.

## DISCUSSION AND CONCLUSION

Transformer models generally outperform RNN models across all imputation methods. Both models perform best with no missing data. Mean imputation leads to the worst performance for both models, with RNN being more severely affected.

Based on the results from the synthetic dataset, the Transformer model emerged as the superior choice for time series forecasting, particularly when dealing with missing data. Among the imputation methods tested, spline and Stineman imputations were identified as the most effective. Notably, the combination of the Transformer model with Stineman imputation proved to be the most efficient and accurate.

These findings underscore the efficacy of the Transformer model, especially when paired with Stineman imputation, in handling incomplete time series data. This combination offers a robust solution applicable in various fields, including big data analytics and financial modeling, providing reliable insights for researchers and practitioners. The study highlights the importance of selecting appropriate imputation methods to preserve the underlying data structure and enhance model performance.

In conclusion, this study contributes to the literature by providing a comprehensive evaluation of imputation methods alongside RNN and Transformer models, guiding practitioners on optimizing model performance despite the presence of missing data. The results emphasize the transformative potential of the Transformer model, particularly when combined with Stineman imputation, in achieving superior forecasting reliability in various applications.

## References

- Farhad Morteza pour Shiri, T. P. (2023). A Comprehensive Overview and Comparative Analysis on Deep Learning Models: CNN, RNN, LSTM, GRU.
- Goodfellow, I. B. (2016). Deep Learning. MIT Press.
- Hochreiter, S., & Schmidhuber, J. (1997). Long short-term memory. *Neural computation*, 9(8), 1735-1780.
- Hodson, T. O. (2022). Root mean square error (RMSE) or mean absolute error (MAE): When to use them or not. *Geoscientific Model Development Discussions*, 2022, 1-10.
- Mugenzi, F. & Yenilmez, İ. (2023). Forecasting for GDP Per Capita Using Multiplier Perceptron and Gated Recurrent Unit. *Akdeniz 10th International Conference on Applied Sciences*, November 2-5, KYRENIA, Proceeding Book (pp.318-327), ISBN: 978-625-6830-49-3.
- Sharma, S., Zhang, M., Gao, J., Zhang, H., & Kota, S. H. (2020). Effect of restricted emissions during COVID-19 on air quality in India. *Science of the total environment*, 728, 138878.
- Szandala, T. (2021). Enhancing deep neural network saliency visualizations with gradual extrapolation. *IEEE Access*, 9, 95155-95161.

- Vaswani, A., Shazeer, N., Parmar, N., Uszkoreit, J., Jones, L., Gomez, A. N., Polosukhin, I. (2017). Attention is all you need. *Advances in neural information processing systems*, 30.
- Yenilmez, I., & Mugenzi, F. (2023). Estimation of conventional and innovative models for Rwanda's GDP per capita: A comparative analysis of artificial neural networks and Box-Jenkins methodologies. *Scientific African*, 22, e01902. <https://doi.org/10.1016/j.sciaf.2023.e01902>.
- Yenilmez, İ. & Akçay, E. K. (2023). Performance of Particle Swarm Optimization and Genetic Algorithm for Tuning of k-NN Hyperparameters. *Akdeniz 10th International Conference on Applied Sciences*, November 2-5, KYRENIA, Proceeding Book (pp.328-338), ISBN: 978-625-6830-49-3.
- Yenilmez, İ. (2024). Imputation methods effect on the goodness of fit of the statistical model. In *Proceedings of the 9th International Conference on Business, Management and Economics*. Vienna, Austria. ISBN 978-609-485-514-6.

### **Acknowledgment**

This study was supported by Eskisehir Technical University Scientific Research Projects Commission under the grant no: 23ADP172.

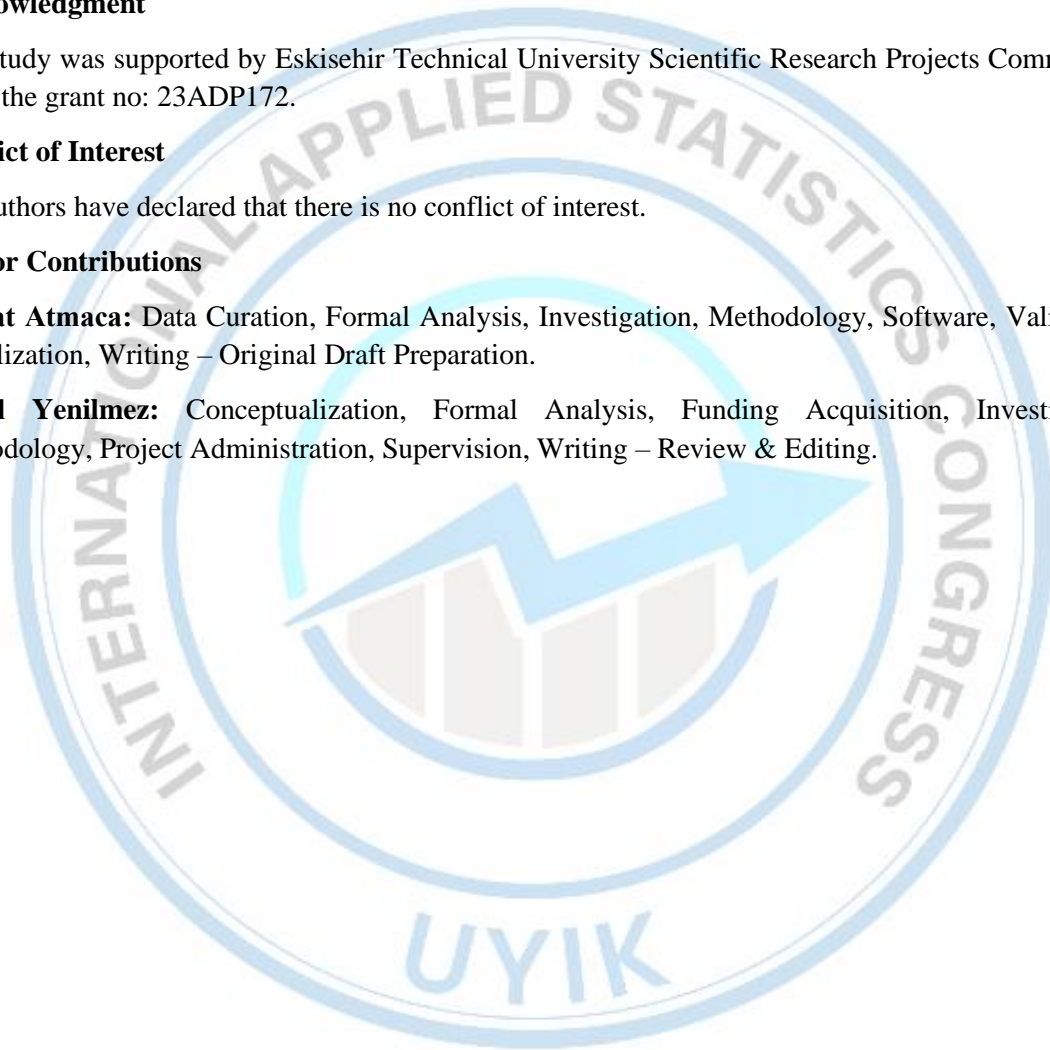
### **Conflict of Interest**

The authors have declared that there is no conflict of interest.

### **Author Contributions**

**Kürşat Atmaca:** Data Curation, Formal Analysis, Investigation, Methodology, Software, Validation, Visualization, Writing – Original Draft Preparation.

**İsmail Yenilmez:** Conceptualization, Formal Analysis, Funding Acquisition, Investigation, Methodology, Project Administration, Supervision, Writing – Review & Editing.





## Explainable Detection of Data Drift Using Partial Dependence Disparity Index in Real Datasets

Ugur Dar<sup>1\*</sup>, Mustafa Cavus<sup>1</sup>

<sup>1</sup>Eskisehir Technical University, Faculty of Science, Department of Statistics, 26470, Eskisehir, Türkiye

\*Corresponding author e-mail: ugurdarr@gmail.com

### Abstract

*The Profile Disparity Index (PDI) was introduced to detect concept drift in machine learning models deployed in real-time data streaming environments. It utilizes the Partial Dependence Profile (PDP) to gauge shifts in how predictors influence model outputs. In this study, we focused on evaluating this approach through extensive experimental studies on real datasets, emphasizing the critical role of continuous model monitoring in dynamic systems. We conducted experiments across two datasets: Chess and Ozone, segmenting each dataset into various batch sizes to assess the presence of data drift. By applying both the Kolmogorov-Smirnov Windowing (KSWIN) tests to identify drift events and incorporate accuracy metrics, we analyzed the models' performance concurrently. Our findings reveal that PDI can effectively highlight critical drift points alongside traditional tests, providing a clear indication of when model behaviors are altering due to underlying data drift. The integration of PDI with traditional drift detection methods like KSWIN not only enhances the interpretability of model behavior changes through PDP but also enables a more nuanced discovery of how these changes evolve. This approach ensures that shifts in the data's influence on predictions are accurately captured and addressed, offering significant insights into the dynamics of model behavior under data drift. The ability to monitor these changes through PDP evolution over time is crucial for maintaining the model in real-time environments. However, our study also uncovers potential areas for improvement in the PDI method's application. The computational cost associated with calculating PDPs necessitates a more efficient sampling technique to better manage resources without compromising the integrity of the analysis. Moreover, the determination of optimal cutoff values for PDI, tailored to specific datasets and variable characteristics, remains a crucial step that requires further refinement. Adjusting these cutoff values based on the dataset could significantly enhance the method's ability to provide timely alerts, ensuring more proactive drift detection. In conclusion, the extensive application of our method across varied setups and datasets has demonstrated its efficacy. It performs well under multiple scenarios, revealing substantial insights into how model behavior evolves and emphasizing the importance of continuous monitoring and adaptation in dynamic environments. This underscores the ongoing need for advancements in the field of eXplainable Artificial Intelligence for real-time data analysis.*

**Keywords:** Explainable artificial intelligence, Explainable detection, Model monitoring, Stream data

### INTRODUCTION

Machine learning (ML) has become integral in various industries such as healthcare, finance, and agriculture, with numerous models being operational in these fields. In these environments, data is often continuously generated and collected, a process referred to as data streaming. Traditional predictive models assume that the data distributions remain stationary and unbiased, meaning that observations in the training and test sets are independent and identically distributed (Cieslak & Chawla, 2009). However, this assumption rarely holds in real-world applications, causing significant declines in model performance (Alaiz-Rodriguez & Japkowicz, 2008). Data drift, which can degrade model accuracy, is

typically divided into three types: (1) Covariate shift, (2) Response variable shift, and (3) Concept shift (Moreno-Torres et al., 2012). Additionally, data drift can be seen as either virtual drift, where there are changes in the distribution of predictors or responses, or concept drift, which involves changes in the relationship between predictors and responses (Celik et al., 2022). To ensure that ML models remain accurate and relevant over time, Machine Learning Operations (MLOps) provides a suite of practices and tools for continuous monitoring, validation, and management of these models. Methods for detecting data drift can be broadly classified into three groups: Statistical, Sequential analysis-based, and Window-based approaches (Masciopinto, 2019). Demsar and Bosnic (2018) argue that existing drift detection methods rely heavily on performance and distribution measures, which do not sufficiently explain the underlying causes of changes in model behavior. Typically, statistical tests are used to identify changes in data stream distributions, or model performance metrics like Accuracy, F1, and RMSE are tracked for significant variations. However, detecting concept drift through statistical tests is difficult because these tests are detached from the ML models and are solely applied to the data. Metric-based approaches, which focus on outcomes, can also fall short in detecting drift when changes in individual predictor contributions cancel each other out. Explainable Artificial Intelligence (XAI) tools are frequently used to analyze the behavior of black-box models in greater detail (Biecek & Burzykowski, 2021). These tools facilitate a detailed examination of how predictors interact with the response variable. The Partial Dependence Profile (PDP) is a commonly used XAI method that assesses how a predictor influences model predictions based on its marginal distribution. The Profile Disparity Index (PDI) measures the dissimilarity between two PDPs, allowing for the comparison of how the predictor-response relationships change over time or across different datasets. In previous research, simulations demonstrated the effectiveness of PDI in detecting various types of drift (Dar & Cavus, 2023). These simulations showed that PDI was successful in identifying drift types. In this study, however, real-world datasets were utilized to further investigate the application of PDI, alongside Kolmogorov-Smirnov Windowing (KSWIN) and Accuracy, to monitor drift. The results indicated that at the points where the drift was detected, PDI effectively identified the drifts and provided results similar to those of KSWIN. However, PDI and PDP offered a more detailed and explanatory view of the drifts within the model, yielding greater insights. In contrast, the KSWIN test primarily focuses on detecting changes in data distribution, which does not provide as detailed an understanding. In this study, PDPs generated from the training data were compared to those from new observations using the PDI, providing insights into how data drift affects model performance.

## MATERIAL AND METHODS

In the literature, data drift arising from these two causes is identified as either virtual concept drift or true concept drift (Celik et al., 2022). Virtual concept drift refers to a scenario where the distribution of input data shifts over time, yet the relationship between the predictors and the response remains constant. In other words, although the data changes in appearance, the core pattern or concept learned by the model remains applicable. Conversely, true concept drift occurs when the fundamental relationship between the predictors and the response alters. This signifies that the patterns the model has learned become obsolete, necessitating model updates or retraining.

*True Data Drift (Concept Drift)*

$$\exists X : P_{t_0}(y | X) \neq P_{t_i}(y | X) , i > 0 \quad (1)$$

This notation indicates that there exists some instance  $X$  where the conditional probability distribution of the response variable  $y$  given  $X$  at the initial time  $t_0$  is different from the conditional probability distribution at any later time  $t_i$ , where  $i > 0$ . In simpler terms, true concept drift occurs when

the relationship between the predictors  $X$  and the response  $y$  changes over time, meaning the patterns or concepts learned by the model no longer hold and the model needs to be updated or retrained.

*Virtual Data Drift*

$$\exists Y : P_{t_0}(y) \neq P_{t_i}(y) , i > 0 \quad (2)$$

$$\exists X : P_{t_0}(X) \neq P_{t_i}(X) , i > 0 \quad (3)$$

These formulas indicate that over time, there is a change in the probability distribution of the response variable  $y$  and the predictors  $X$ . Specifically, the distribution of  $y$  at the initial time  $t_0$  is different from its distribution at any later time  $t_i$ , and similarly, the distribution of  $X$  at  $t_0$  is different from its distribution at  $t_i$ . However, unlike true concept drift, virtual concept drift does not alter the relationship between the predictors  $X$  and the response  $y$ . Essentially, while the input data  $X$  and the output  $y$  may change in appearance or distribution over time, the underlying pattern or relationship that the model has learned remains valid. This means that the model's predictions remain accurate without the need for retraining, as the core concept or pattern within the data has not changed, only the distribution of the data itself has shifted. It is important to note, however, that these changes in distribution could signal potential future concept drift. If the distribution changes continue or evolve, it might eventually lead to true concept drift, where the relationship between predictors and the response variable does change, necessitating a model update or retraining.

*Proposed Explainable Approach for Detecting Data Drift*

Partial Dependence Profile (PDP) values of the models were derived and subsequently compared using the Profile Disparity Index (PDI). PDP is an important tool in explainable artificial intelligence (XAI) that quantifies the impact of individual variables on the predicted outcomes of a model, based on their marginal distributions. This method provides insights into how variations in a single variable can influence the model's predictions, thereby enhancing the interpretability of the model's decision-making process (Biecek & Burzykowski, 2021). PDI is utilized to measure the dissimilarity between the PDPs of different models, allowing for a rigorous comparison of how each model responds to changes in the predictor variables. This comparative analysis aids in understanding the consistency and reliability of the models in varying data conditions.

In this context,  $f()$  represents the trained model, and  $x_i^{j=z}$  indicates the value of the  $j$ . variable in the state  $z$ .

$$\hat{g}_{PD}^i(z) = \frac{1}{n} \sum_i f(x_i^{j=z}) \quad (4)$$

where,  $f()$  represents the trained model, and  $x_i^{j=z}$  indicates the value of the  $j$ . variable in the state  $z$ . PDI quantifies the dissimilarity between two PDPs by comparing their shapes, providing a measure of how different the new PDPs are from each other (Kobylinska et al., 2023). Different PDPs can be generated for various models or different observations within the same model, and the PDI is



utilized to assess the differences between these profiles. This index evaluates the structural variations between the profiles, enabling a comprehensive analysis of the model's behavior in response to changes in the input variables.

$$\widehat{PDI}(\hat{g}_{f_1}^j, \hat{g}_{f_2}^j) = \frac{1}{m} \sum_{i=1}^m I(\text{sgn}(\text{der}(\hat{g}_{f_1}^j)[i]) \neq \text{sgn}(\text{der}(\hat{g}_{f_2}^j)[i])) \quad (5)$$

Here,  $m$  consecutive points of the profile for the  $k^{\text{th}}$  model. The term  $\text{der}(\hat{g}_{f_k}^j)[i]$  represents the  $i^{\text{th}}$  element of the vector derivative for the model  $f_k$  and predictor  $j$ . The PDI range is  $[0,1]$ : a value of zero indicates identical curves, while a value of one signifies distinctly different curves.

#### Kolmogorov-Smirnov Test-based Windowing Concept Drift Detection (KSWIN)

KSWIN is a non-parametric method used to detect concept drift in data streams (Raab et al., 2020). It operates by maintaining a sliding window ( $\Psi$ ) that keeps the most recent  $n$  data points. Two sub-windows are created from  $\Psi$ :

$R$ , which contains the  $r$  most recent data points:

$$R = \{x_i \in \Psi \mid i > n - r\} \quad (6)$$

$W$ , which contains  $r$  uniformly sampled data points from the older part of the window:

$$W = \{x_i \in \Psi \mid i \leq n - r \wedge P(x) = UNIF(x_i \mid 1, n - r)\} \quad (7)$$

The Kolmogorov-Smirnov (KS) test is then applied to compare the empirical cumulative distributions of  $R$  and  $W$ . The test calculates the maximum absolute difference ( $dist_{w,r}$ ) between these distributions:

$$dist_{w,r} = \sup_x |F_W(x) - F_R(x)| \quad (8)$$

If this distance exceeds a critical value ( $D_\alpha$ ), concept drift is detected:

$$dist_{w,r} > c(\alpha) \sqrt{\frac{n+r}{nr}} = \sqrt{-\frac{1}{2} \ln \alpha} \sqrt{\frac{n+r}{nr}} = \sqrt{-\frac{\ln \alpha}{r}} \quad (9)$$

KSWIN is advantageous because it does not make assumptions about the underlying data distribution, making it versatile and suitable for various applications. By effectively balancing sensitivity and specificity, KSWIN provides a robust mechanism for real-time concept drift detection, ensuring the accuracy and reliability of predictive models in dynamic environments.

## RESULTS

In this study, experiments were conducted on two real-world datasets frequently used in the literature. Firstly, the datasets were divided into five parts. A random forest model was trained on the first part without any hyperparameter optimization. Subsequently, the accuracy and Partial Dependence Profile (PDP) values were calculated for the first part. The data in the 2nd, 3rd, 4th, and 5th parts were used as test sets to compute their respective accuracy and PDP values. The PDP values obtained from the first

part were then compared with those obtained from the 2nd, 3rd, 4th, and 5th parts using the Profile Disparity Index (PDI). Additionally, accuracy metrics were employed to evaluate model performance. Furthermore, the well-known KSWIN test from the literature was applied using the same methodology.

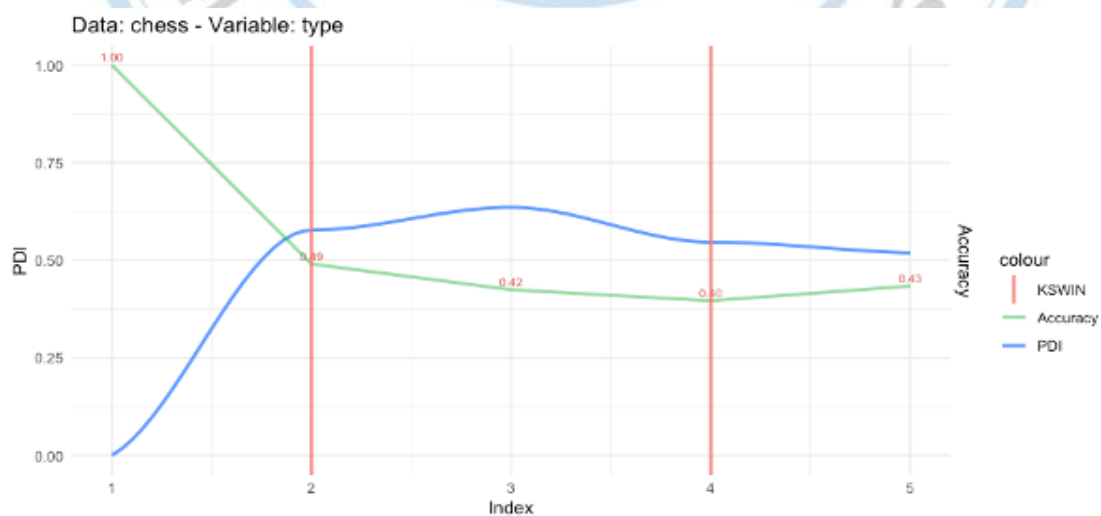
**Chess:** The dataset includes two years of chess games collected from chess.com (Scheible et al., 2011). The primary aim is to predict whether a player will win or lose a match based on player-specific and game-setup features. Data drift is expected in this dataset, which is frequently utilized in studies related to data drift in the literature. It consists of 533 observations and 8 variables. The dependent variable in this dataset is binary.

**Ozone:** The dataset comprises air measurements collected from 1998 to 2004 in the Houston, Galveston, and Brazoria areas (Zhang et al., 2008). The variables include sensor data such as temperature, wind speed, and humidity. This dataset is frequently used in studies related to data drift in the literature. It contains 2,534 observations and 72 variables. The dependent variable in this dataset is binary.

In Fig. 1 and Fig. 2, the vertical axis of the graphs represents both PDI values and accuracy, with the red lines indicating the data batches where the KSWIN test detected concept drift. The blue line denotes the PDI values, while the green line indicates the accuracy values.

Upon analyzing the PDI values of various variables within the Chess dataset, the type variable exhibited the highest PDI value and was therefore included in this analysis. The graph reveals that the model's performance has declined over time. The KSWIN test identified data drift in the type variable at the second and fourth data batches, as marked by the red vertical lines. Notably, there is a significant increase in the PDI value in the second batch, suggesting a substantial shift in the relationship between the type variable and the dependent variable.

This analysis indicates that the distribution of the type variable has changed over time. The pronounced increase in the PDI value in the second batch implies that the relationship between the type variable and the dependent variable has also shifted. This is corroborated by the corresponding decline in model accuracy, emphasizing the impact of data drift on model performance. By examining both PDI and KSWIN test results, it becomes evident that the type variable has undergone significant changes, affecting the model's predictive capability.



**Figure 1.** Results of experiments on the Chess dataset, showing the changes in PDP and PDI values over time for type variable.

In Fig. 2, the changes in PDP values over time for two different sensors in the Ozone dataset are depicted. While the model's accuracy remains relatively stable across different data batches, the PDI values for some sensors exhibit significant variations, whereas others show minimal changes. This indicates that relying solely on accuracy might not provide a comprehensive understanding of model performance and data drift.

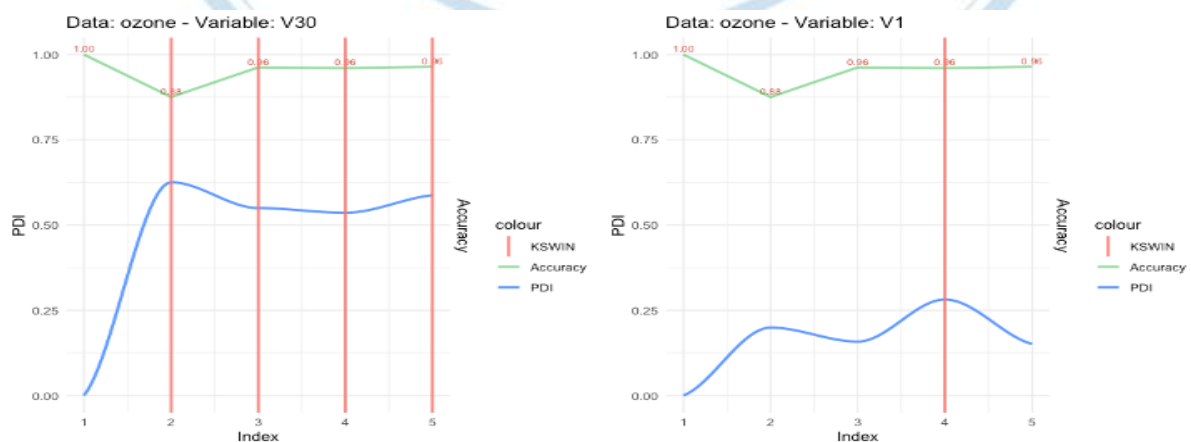
In the left graph, for the variable V30, there is a sharp increase in the PDI value in the second batch, which corresponds with a noticeable drop in accuracy. This suggests a substantial shift in the relationship between the sensor and the dependent variable during this period. Following this spike, as accuracy improves, there is a slight decrease in the PDI value, indicating a partial recovery in the model's predictive capability regarding this sensor.

On the right side, for the variable V1, the PDI value does not exhibit significant fluctuations, and the accuracy remains high and stable. This implies that there has not been a considerable change in the data distribution for this sensor, and the model's performance remains unaffected.

The red vertical lines in both graphs represent the KSWIN test results. These lines indicate points in the data batches where the KSWIN test has detected a significant concept drift. In the left graph, the KSWIN test detects drifts in the second and fourth batches, which aligns with the observed changes in PDI and accuracy. This further confirms the utility of KSWIN in identifying significant shifts in data distribution that impact model performance. On the right graph, the KSWIN test detects a drift at the fourth batch, although the PDI and accuracy do not show significant changes, suggesting that while there is a detected drift, its impact on model performance for this sensor is minimal.

These observations highlight that while some sensors exhibit substantial changes in their relationship with the dependent variable, others do not. The PDI proves to be a valuable tool in detecting and analyzing these changes. By examining PDI values alongside accuracy, deeper insights into the model's robustness and the stability of its predictions can be obtained. The integration of KSWIN further enhances the analysis by providing precise points of detected drifts, allowing for a comprehensive understanding of data dynamics.

This analysis underscores the importance of using PDI in conjunction with accuracy and KSWIN to identify potential issues and understand the underlying data dynamics. It can be particularly useful for pinpointing specific sensors or variables that are contributing to data drift, thereby aiding in targeted model improvements and ensuring reliable predictive performance over time.



**Figure 2.** Results of experiments on the Ozone dataset, showing the changes in PDP and PDI values over time for sensors V30 and V1.



## DISCUSSION AND CONCLUSION

This study investigated the application of various drift detection methods on two real-world datasets commonly referenced in the literature. The datasets were divided into five parts, and a random forest model was trained on the first part without any hyperparameter optimization. Accuracy and Partial Dependence Profile (PDP) values were calculated for the first part, while the remaining parts were used as test sets to compute their respective accuracy and PDP values. The Profile Disparity Index (PDI) was employed to compare the PDP values across different parts, and accuracy metrics were also used to evaluate model performance. Additionally, the well-established KSWIN test was applied using the same methodology. In the *Chess* dataset, data collected from chess.com over two years was used to predict match outcomes based on player-specific and game-setup features. The analysis revealed significant data drift, particularly in the `type` variable, which exhibited the highest PDI value.

The KSWIN test detected drifts at the second and fourth data batches, aligning with noticeable increases in PDI and corresponding declines in accuracy. This indicates a substantial shift in the relationship between the `type` variable and the dependent variable, emphasizing the impact of data drift on model performance. The *Ozone* dataset, comprising air measurements from the Houston, Galveston, and Brazoria areas, was used to examine the changes in PDP values for two different sensors. While the model's accuracy remained relatively stable across different data batches, the PDI values showed significant variations for some sensors, such as `V30`, indicating shifts in the sensor's relationship with the dependent variable. The KSWIN test identified significant drifts at similar points, confirming its utility in detecting data distribution changes that affect model performance. However, the PDI and PDP provided more detailed insights into the nature of these changes, offering a deeper understanding of the underlying data dynamics. This research highlights the importance of using PDI alongside accuracy and KSWIN to comprehensively detect and understand data drift. The PDI proves to be a valuable tool for identifying shifts in predictor-response relationships, offering detailed explanations that are not captured by accuracy metrics alone. KSWIN complements this by pinpointing specific data batches where significant drifts occur, although it does not provide the same level of detail regarding the nature of these changes. By integrating PDI, PDP, and KSWIN, this study demonstrates a robust approach to monitoring and addressing data drift in ML models. These methods collectively enhance the ability to maintain model accuracy and reliability over time, ensuring that predictive performance remains robust in the face of changing data distributions. This integrated approach can be particularly beneficial for identifying and addressing specific variables or sensors contributing to data drift, thereby supporting targeted model improvements and more reliable operational outcomes.

## References

- Celik, B., Singh, P., and Vanschoren, J. 2022. "Online AutoML: An adaptive AutoML framework for online learning". *Machine Learning*, 1-25.
- Cieslak, D. A., and Chawla, N. V. 2009. "A framework for monitoring classifiers' performance: when and why failure occurs?" *Knowledge and Information Systems*, 18(1), 83-108.
- Biecek, P., Burzykowski, T. 2021. "Explanatory model analysis", Chapman and Hall / CRC Press, ISBN: 9780367135591.
- Kobylińska, K., Krzyżiński, M., Machowicz, R., Adamek, M., & Biecek, P. (2023). Exploration of Rashomon Set Assists Explanations for Medical Data. arXiv preprint arXiv:2308.11446.
- Scheible, Christian and Hinrich Schütze. 2014. Picking the Amateur's Mind - Predicting Chess Player Strength from Game Annotations. *Cooling 2014*
- Zhang, Kun, Fan,Wei, and Yuan,XiaoJing. 2008. Ozone Level Detection. UCI Machine Learning Repository. <https://doi.org/10.24432/C5NG6W>.

- Dar, U., Cavus, M. 2023. A novel concept drift detection method based on the partial dependence profile disparity index. Paper presented at the 7th International Researchers, Statisticians, and Young Statisticians Congress, Istanbul, Türkiye.
- Alaiz-Rodríguez, R., and Japkowicz, N. (2008). Assessing the impact of changing environments on classifier performance. In *Advances in Artificial Intelligence: 21st Conference of the Canadian Society for Computational Studies of Intelligence, Canadian AI 2008 Windsor, Canada, May 28-30, 2008 Proceedings 21* (pp. 13-24). Springer Berlin Heidelberg.
- Demšar, J., and Bosnić, Z. 2018. "Detecting concept drift in data streams using model explanation". *Expert Systems with Applications*, 92, 546-559.
- Friedrich, B., Sawabe, T., & Hein, A. 2023. "Unsupervised statistical concept drift detection for behavior abnormality detection", *Applied Intelligence*, 53(3), 2527-2537.
- Masciopinto, F. 2019. "Comparison of concept drift detectors in a health-care facility dataset to detect behavioral drifts".
- Moreno-Torres, J. G., Raeder, T., Alaiz-Rodríguez, R., Chawla, N. V., and Herrera, F. 2012. "A unifying view on dataset shift in classification". *Pattern recognition*, 45(1), 521-530.
- Raab, C., Heusinger, M., & Schleif, F. M. (2020). Reactive soft prototype computing for concept drift streams. *Neurocomputing*, 416, 340-351.

### **Acknowledgment**

The work on this paper is financially supported by the Scientific and Technological Research Council of Türkiye under the 2210C National MSc Scholarship Program in the Priority Fields in Science and Technology grant no. 1649B022303919 and Eskisehir Technical University Scientific Research Projects Commission under grant no. 22LÖT175.

### **Conflict of Interest**

The authors have declared that there is no conflict of interest.

### **Author Contributions**

All authors contributed to the study: Ugur Dar worked on the introduction, and methods section and also on the implementation of applications and results section, and Mustafa Cavus focused on the research question, design, and framework of the study.

## Implementation of A Risk Assessment Model Aimed at Preventing Operational Errors in a Glass Factory

Necati Yağız Zeybek<sup>1\*</sup>, Ezgi Aktar Demirtaş<sup>2</sup>

<sup>1</sup>Türkiye Sise ve Cam Fabrikalari A.S, SiseCam Glassware Eskisehir Plant, 26250, Eskisehir, Türkiye  
<sup>2</sup>Eskisehir Osmangazi University, Industrial Engineering, Quality Management and Quality Assurance  
Systems, 26040, Eskisehir, Türkiye

\*Corresponding author e-mail: nyagizzeybek@gmail.com

### Abstract

*Failure Modes and Effect Analysis (FMEA) is an analysis technique aimed at reducing or eliminating the damages caused by errors that may occur in the production processes of businesses. This analysis helps businesses improve quality by reducing costs.*

*In this study, an FMEA was conducted for the press production, one of the glass production processes. As a result of the analysis, possible error types were identified. The current situation for a mold produced by the press production process was analyzed. To address the primary root cause of errors leading to production losses, an automatic weight measurement system has been installed to control the variation in gob weight, and an automation system has been implemented to instantly detect the accuracy of product dimensions.*

*Managing gob weight and product dimensions through statistical process control aims to control gob weight, reduce quality costs, decrease scrap rates and optimize labor.*

**Keywords:** *Failure Modes and Effect Analysis (FMEA), Process FMEA, Control Plan, Statistical Process Control, Measurement System Analysis, Process Capability Analysis*

### INTRODUCTION

Glass, simply put, is a brittle and transparent material. Due to its ability to transmit light, it allows us to perceive images on the other side. It has a smooth surface. Depending on its use, glass must have a certain mechanical strength. It should also be resistant to water, acidic, and basic solutions. Generally, glass is defined as a material with an amorphous structure obtained by mixing organic and inorganic raw materials in specific proportions, melting the mixture at high temperatures, and then rapidly cooling the high-viscosity, homogeneous, and pure melt without allowing it to crystallize at room temperature. When producing glass, crystallization must be strictly avoided. A semi-glass, semi-crystalline material cannot achieve the expected levels of thermal shock resistance, mechanical, and chemical strength.

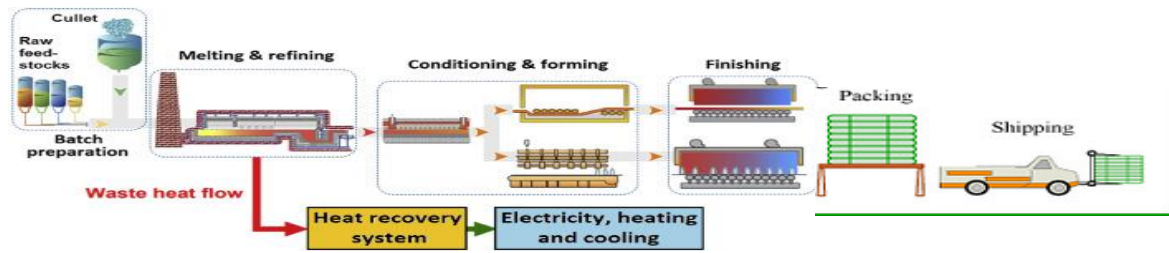
Glass is a monolithic material, meaning it exhibits the same properties throughout its entirety. It is a strategically important material due to its widespread use. Glass is an essential material used in various sectors such as construction, food, automotive, pharmaceuticals, maritime, and household goods. The reason for its extensive and diverse range of applications is due to its superior qualities.

The glass factory where the study was conducted has been operating since 1997. It has three active furnaces with a production capacity of 525 tons of glass per day. The annual glass production capacity is 191,625 tons, equivalent to approximately 400 million units per year. The production process includes six different types of production: Press Blown and Stemware Production, Press Production, Industrial Product Production, Pulled Stem Production, Press-Press Blown Production, and IS Production.

Glass manufacturing process consists primarily of the following steps, Batch Preparation, Glass Melting, Forehearth, Shaping, Annealing/Tempering, Packaging, Storage, and Shipping (Table 1)



**Table 1.** Basic Schematic of the Glass Production



The study aims to create a dataset for operational errors encountered in the current state of the Press Production process, determine the distribution of errors, review process flows, conduct a Failure Mode and Effects Analysis (FMEA) for the process, identify prominent types of errors, update existing control plans based on the FMEA study, perform Measurement Systems Analysis (MSA) to assess measurement and equipment adequacy, compare process capability between the current process and automated processes through statistical process control studies, conduct root cause analysis for identified issues, implement actions to reduce operational errors, decrease quality costs, and enhance operational efficiency.

## MATERIAL AND METHODS

### Material

FMEA (Failure Mode and Effects Analysis), used to identify and prevent potential errors in the design or production process of a product or service, allows for the detection of potential failures at each stage of the product lifecycle and offers solutions to prevent these failures. Recognized as a risk analysis method, FMEA is widely employed, particularly in industries such as automotive, aerospace, and defense (Stamatis, 2011).

It is an analysis technique aimed at reducing or eliminating the damages caused by errors in production processes of businesses. This analysis helps businesses reduce costs and improve quality by identifying potential failures and implementing preventive measures. To detect potential errors in products or processes, assess their potential impacts, and reduce risks by implementing preventive or corrective measures.

In FMEA studies, it is crucial that all team members, depending on their roles within the team, possess sufficient experience and competence. It is essential to ensure that the objectives and goals of FMEA are understood by all team members. Fundamentally, all these objectives can be grouped under the heading of profitability.

Team members from different units of the business should have a deep understanding of how their tasks impact product profitability. They should leverage their expertise and knowledge right from the beginning of the project.

Understanding the limits of cost analysis, and knowing how conditions and customer demands influence product cost and profitability, will enhance the team's seriousness about the matter.

Products that are not correctly produced in the first attempt or in the first production stage behave as sources of errors throughout the project, dampening profitability. Additionally, these factors lead to secondary issues such as increased setup times, rework costs, and return costs.

Process FMEA (Failure Mode and Effects Analysis) is employed to evaluate potential error modes occurring during the production process of a product and their impacts. It assists in reducing the risk of process failure and is a crucial tool in quality management (Venkatesh and Ramanujam, 2009; Gupta and Singh, 2015).

The control plan is essentially a method that facilitates understanding of the process by outlining all necessary inspections from the moment raw materials or product components enter the company to the shipment stage. It is crucial to define all inspections that need to be conducted, specifying who will measure critical dimensions and features, when, with what equipment, according to what criteria, and where records will be kept. This document, the control plan, ensures clarity on measurement and feature specifications and should equip us with specialized capabilities such as alternative control methods, emphasizing critical and characteristic features.

Each type of inspection, measurement, and testing equipment (systems) defined in the control plan should undergo statistical studies to analyze the variability in their results. The analytical methods used and acceptance criteria will adhere to information found in reference handbooks related to Measurement Systems Analysis (MSA).

It is not always possible to achieve the theoretical value in measurement results due to various errors made during the process, resulting in a value that includes deviation. MSA analyzes the difference from the true value and assesses the measurement error, establishing the confidence level in the measured value.

Statistical Process Control (SPC) is used to monitor whether processes are under statistical control. Its objective is to control the process by eliminating special causes of variation. If a process is statistically in control and consistently producing parts within its natural tolerance limits, these natural tolerances should not be confused with specification tolerances when assessing process capability.

The fact that values obtained from the production process fall within specified limits does not necessarily mean the production process is under control. The goal is to control the process by eliminating special causes of variation. To ensure that the process is under control, it must be statistically analyzed. Processes that are not under statistical control will have a defective product rate above acceptable levels. Statistical Process Control (SPC) practices should be implemented to reduce the defective product rate below acceptable levels.

### Methods

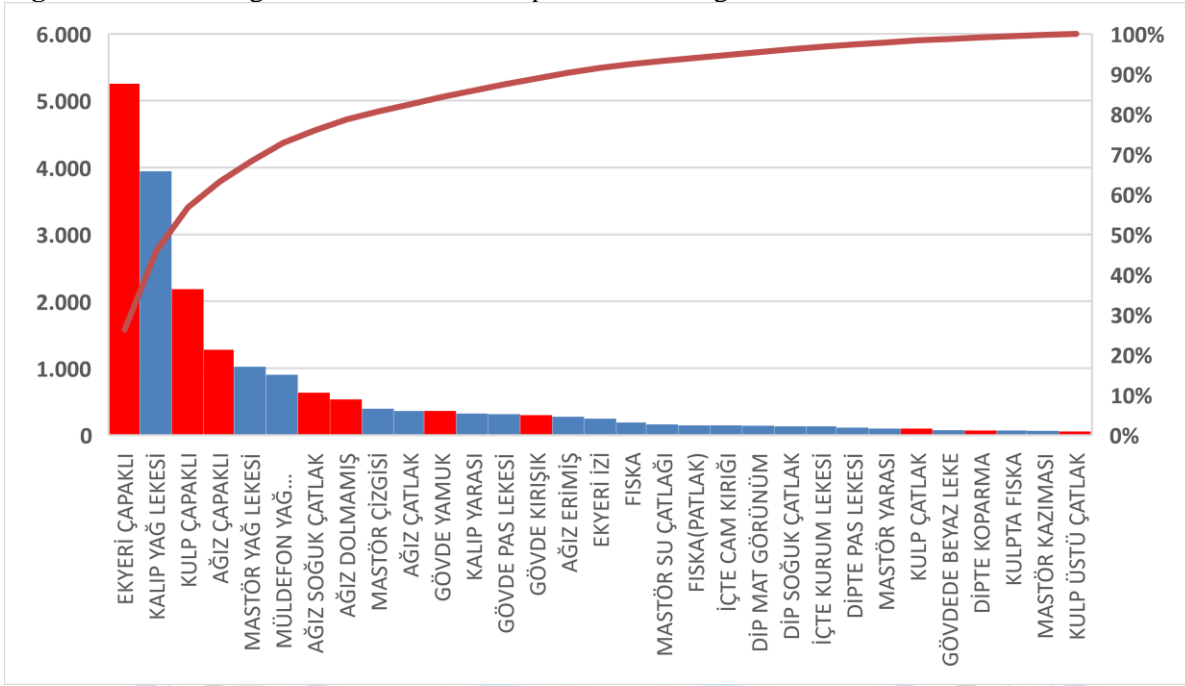
In this study, previous years' press productions have been examined, focusing specifically on the tea glass with handle which has the highest production volume.

**Table 2.** Tea Glass with Handle Production Data for 2023

	Production Data	Unit
2023 Total Production	13.899.066	pcs
2023 Good Production	13.003.211	pcs
Total Number of Errors	895.854	pcs
Error Rate	6,45	%

Process reports of defective products were reviewed to prepare a Pareto diagram based on error types.

**Figure 1.** Pareto Diagram for the Process Reports of the tea glass with handle



According to the analysis, it was found that 54.8% of defective products were attributed to errors related to gob weight.

**Table 3.** Tea Glass with Handle Production Analysis for 2023

	Production Data	Unit
2023 Total Production	13.899.066	pcs
2023 Good Production	13.003.211	pcs
Total Number of Errors	895.854	pcs
Error Rate	6,45	%
Number of Errors Due to Weight	490.617	pcs
Average Weight per Product	207,74	gr
Glass Loss Due to Weight	101.921	kg
Cost of Losses Due to Weight Error	3.742.532	₺

After conducting production analyses for the year 2023, a process flow and Process FMEA study were prepared.



Figure 2. Process FMEA for the Tea Glass with Handle – Severity Scores

Process General Evaluation Criterion – Severity (S)					
Potential Error Impacts are rated according to the following criteria.					
S	Effect	Impact on Your Organization's Site	On the Site to be Shipped Effect (if known)	Impact on End User (if known)	Organization or Product Line Examples
10	Very High	Error may cause severe health and/or safety risks to production or assembly workers.	Error may cause severe health and/or safety risks to production or assembly workers.	It affects the safe use of the vehicle and/or other vehicles and the health of the driver, passengers or road users or pedestrians.	
9		Error may result in non-compliance with internal regulations.	Error may result in non-compliance with internal regulations.	Non-compliance with legal regulations.	
8	Partly High	100% of affected manufacturing operations may need to be scrapped.	A line stop longer than the entire production shift; shipment is likely to be stopped; In addition to regulatory non-compliance, field repair or replacement may be required (End User Installation).	Loss of primary vehicle function required for normal use of the vehicle within its expected service life.	
7		The product may need to be sorted and some (less than 100%) scrapped; Deviation from the primary process; A decrease in line speed or additional labor may be required.	Stopping the line from 1 hour to a full production shift; It is possible that the shipment will be stopped; In addition to regulatory non-compliance, field repair or replacement may be required (End User Installation).	Deterioration of the primary vehicle function required for normal use of the vehicle within its expected service life.	
6	High	100% of production parts may need to be reworked and accepted off-line.	Line downtime for up to one hour.	Loss of secondary vehicle function.	
5		Some of the production parts may need to be reprocessed and accepted off-line.	Less than 100% of products are affected; Significant possibility of additional defective products; Sorting may be required; No line stoppage required.	Impairment of secondary vehicle function.	
4		100% of production parts may need to be remachined on the line before they can be processed.	Defective product activates an important reaction plan; No additional defective product is expected; No sorting required.	Very seriously objectionable appearance, sound, vibration, shock or tactile perception.	
3	Low	Some of the production parts may need to be remachined down the line before they can be processed.	The defective product activates a minor reaction plan; No additional defective products are expected; No sorting required.	Partially objectionable appearance, sound, vibration, shock or tactile perception.	
2		Slight inpropriety in terms of process, operation or operator.	Defective product does not activate the reaction plan; No additional defective product is expected; No extraction is required; feedback to the supplier is required.	Slightly objectionable appearance, sound, vibration, shock or tactile perception.	
1	Very Low	No visible effect.	No visible effect or no effect at all.	No visible effect.	

Figure 3. Process FMEA for the Tea Glass with Handle – Probability Scores

Occurrence Probability Potential (O) for the Process						
Potential Error Causes are ranked according to the following criteria. When determining the best Likelihood estimate, also consider Preventive Controls. Probability of Occurrence is a predictive numerical rating made during evaluation and may not reflect the actual rate of occurrence. The Likelihood of Occurrence rating number is a relative rating within FMEA (the process being evaluated). For Preventive Controls with Likelihood of Multiple Occurrence ratings, use the rating that best reflects the robustness of the control.						
P	Estimation of Probability of Cause of Error	Number of Cases per 1000 Parts/Vehicles	Time Based Error Estimation Value	Control Type	Preventative Controls	Organization or Product Line Examples
10	Extremely High	≥ Greater than 100 per thousand	Always	None	No preventive control.	
9	Very High	≥ 1 in 10	Almost Always	Behavioral	Preventive controls have little effect in preventing the cause of error.	
8		50 per thousand	More than 1 Time per Shift			
7	High	1 in 20	More Than Once a Day	Behavioral or Technical	Preventive controls identify the cause of the error somehow effective in preventing it.	
6		20 per thousand	More than Once a Week			
5	Medium	1 in 50	More than Once a Month		Preventive controls are effective in preventing the cause of error.	
4		10 per thousand	More than Once a Year			
3	Low	1 in 100	Once a Year	Best Practices: Behavioral or Technical	Preventive controls are very effective in preventing the cause of error.	
2	Very Low	2 per thousand	Less Than Once a Year			
1	Extremely Low	1 in 500	Never	Technical	Preventive controls are extremely effective in preventing the cause of error from design (e.g. part geometry) or process (e.g. fixture or mold design). Purpose of preventive controls – Due to the Error Cause, the Error Type cannot be physically produced.	

Figure 4. Process FMEA for the Tea Glass with Handle – Detection Scores

Detection Potential (D) for Process Design Validation				
Detection Controls are rated based on Detection Maturity and Detection Ability.				
D	Detection Ability	Detection Method Maturity	Possibility of Detection	Organization or Product Line Examples
10	Very Low	There is no established or known test or examination method.	The Error Type will not or cannot be detected.	-
9		The test or inspection method is very unlikely to detect the type of fault.	Error Type is not easy to detect by random or occasional inspections.	-
8	Low	The test or inspection method has not yet been proven to be effective or reliable. (E.g. the facility has little or no experience with the method, G R&R results are low on the comparable process or this application, etc.)	Use of individual inspection (visual, tactile, auditory), or manual measurement (qualitative or quantitative) that must detect the type of error or cause of the error.	Control method <1 Year History GRR in the range of 10%-20%
7		The use of control equipment such as a machine-based control (automatic or semi-automatic with light or sound warning) or a coordinate measuring machine that must detect the type of error or cause of the error.	Qualitative Effectiveness in the range of 85% - 90%	
6	Medium	The test or inspection method has been proven to be effective or reliable (e.g., the facility has experience with the method, GR&R results are comparable to the process or acceptable on this application, etc.).	Use of individual inspection (visual, tactile, auditory), or manual measurement (qualitative or quantitative) to detect the type of error or cause of the error. (Including product sample control)	Control method >1 Year History Owner GRR below 10%
5		Use of control equipment such as a machine-based control (automatic or semi-automatic with light or sound warning) or a coordinate measuring machine that will detect the type of error or cause of the error. (Including product sample control)	Qualitative Effectiveness >90%	
4	High	The system has been proven to be effective and reliable (e.g. the facility has experience with the method on the same process or this application G R&R results are acceptable on the comparable process or this application, etc.)	The machine-based automatic detection method, which will detect the type of error in the next process, will prevent further processing or the system will identify the product as different and allow it to be automatically delivered to the designated rejection area in the process. The different product will be a powerful system that will prevent the product from leaving the facility, would be controlled.	
3		The machine-based automatic detection method, which will detect the type of error at the station, will prevent further processing or the system will identify the product differently and allow it to be automatically delivered to the designated rejection area in the process. The different product will be controlled by a powerful system which will prevent the product from leaving the facility.		
2		The detection method has been proven to be effective and reliable (e.g. the facility has experience with the method, error-free verifications, etc.).	Machine-based detection method that will detect the cause and prevent the type of error (different product) from occurring.	
1	Very High	The type of error cannot be physically produced as designed or processed, or proven detection methods always detect the type of error or cause of the error.		

Quantitative Gage R&R studies have been conducted for 9 personnel performing measurements using equipment such as calipers, height gauges, micrometers, and weight scales to assess the reliability of the measurement systems.

Statistical Process Control applications have generated a dataset of 1080 drip weights from the press manufacturing process. The process capability of the handled tea cup product has been investigated.

RESULTS

In the prepared FMEA, analysis was conducted on 609 potential causes of errors, out of which 232 were identified as high priority for which action plans were developed. It was found that 112 of these actions were attributed to root causes related to drop weight errors.

Figure 5. Process FMEA for the Press Production (Tea Glass with Handle)

No	STRUCTURE ANALYSIS (STEP 2)			FUNCTION ANALYSIS (STEP 3)			FAILURE ANALYSIS (STEP 4)			PFMEA RISK ANALYSIS (STEP 5)						
	1. Process Item, System, Subsystem, Part Element or Name of Process	2. Process Step Station No. and Name of Focus Element	3. Process Work Element SM Type	1. Function of Process Item System, Subsystem, Part Element or Name of Process	2. Function of the Process Step and Product Characteristics	3. Function of the Process Work Element and Process Characteristics	1. Failure Effect to the Next Higher Level Element and/or End User	Severity (S) of Eff	2. Failure Mode (FM) of the Focus Element	3. Failure Cause (FC) of the Next Lower Element or Characteristics	Current Prevention Control (PC) of FC	Occurrence (O)	Current Detection Controls (DC) of FC or FM	Detection (D) of FC or FM	RPN	Control to Quality
381	75 Soğuk Kaplama	Paketleme Alanına Transfer	Makine	Soğuk paketleme alanına transfer edilmesidir. Müşteri: Müşteri gereksinimlerine uygun ürünün paketlenmesi için uygun şekilde paketlenmesi ve taşıma yapılmasıdır. SK: Hatazaze ürün kullanımı.	Soğuk kaplama süreci tamamlandığında ürünün uygun şekilde paketlenmesi ve taşıma yapılmasıdır. SK: Hatazaze ürün kullanımı.	Vibro sarazak sistemindeki titreşim ile ürünün soğukta kalması ve paketlenmesi konveyörüne transfer edilmesidir.	Sistemdeki titreşim nedeniyle ürünün paketlenmesi uygun olmayan ürünlere sebep olabilir.	6	Taşkın hatazaze oranı ideal olmaması nedeniyle ürünün birleşim bölümlerinde bulunan diğer ürünlerle birlikte paketlenmesi olabilir.	Vibro sarazak sisteminin ayarlanması	İHD'de titreşim ayarları yapılması	4	Görsel Kontrol	3	M	SC
382	75 Proses Kontrol	75 Proses Kontrol	İnsan	SO: Limit numaranın okunması. Müşteri: Kalite kontrolüne uygun şekilde paketlenmesi. SK: Müşteri istek ve beklentilerine uygun ürün.	İmalata uygun limit numaranın okunması.	Fabrikatör arızası aktarılan kaplamada numune kontrolü için personel tarafından yapılmasıdır.	Yanlışlıkla imalatın yanlış yönetilmesi. Müşteri: İmalat süreci yönetilmediği için kalite kontrolünün bilinmemesi nedeniyle yanlış ürünler üretilmesi. SK: Müşteri istek ve beklentilerine uygun olmayan ürünler.	9	Limit numaranın okunmaması.	Fabrikatör arızası aktarılan kaplamada numune kontrolü için personel tarafından yapılmasıdır.	Personellerin diğer fabrikalardan gelen diğer ürünlerin gözetimine göre fabrikatörün istediği kabul numarası ve istenilen formata sahip ürünleri kontrol etmesi.	7	Ayıkta proporsiyona göre kontrol edilerek kalibrasyon numarası ile kontrol edilir.	4	H	CTQ (Control to Quality)
383	75 Proses Kontrol	75 Proses Kontrol	Makine	SO: Harabân SAP'ye girilmesi. Müşteri: Kalite kontrolüne uygun şekilde paketlenmesi. SK: Müşteri istek ve beklentilerine uygun ürün.	Harabân SAP'ye uygun girilmesi.	Ürün kontrolünde tespit edilen hatalar SAP sisteminde veri girişi yapılmamasıdır.	Müşteri: İmalat süreci yönetilmediği için kalite kontrolünün bilinmemesi nedeniyle yanlış ürünler üretilmesi. SK: Müşteri istek ve beklentilerine uygun olmayan ürünler.	7	Harabân SAP'ye girilmemesi.	Sistem arızası	Test sonuçları manuel kontrol formuna girilmesi.	2		6	M	SC
384	75 Proses Kontrol	75 Proses Kontrol	İnsan	SO: Müşteri özel testlerinin yapılması. Müşteri: Kalite kontrolüne uygun ürünün paketlenmesi. SK: Müşteri istek ve beklentilerine uygun ürün.	Müşteri özel testlerinin kalite kontrolü için personeller tarafından yapılmasıdır.	Kalite Kontrol (çalıştır) personeller tarafından müdahale edilerek testler yapılır. Kişiler arızasıdır.	Müşteri: İmalat süreci yönetilmediği için kalite kontrolünün bilinmemesi nedeniyle yanlış ürünler üretilmesi. SK: Müşteri istek ve beklentilerine uygun olmayan ürünler.	8	Müşteri özel testlerinin yapılmaması.	Çalışan testi yapmaması.	Çalışan eğitim verilmesi & Müşteri bilgi notlarının hazırlanması.	4	Müşteri özel testlerinin kalite kontrolü için personeller tarafından yapılmasıdır.	6	M	SC
385	75 Proses Kontrol	75 Proses Kontrol Çıktı Kontrolü	Makine	SO: Hatazaze ve Müşteri Spesifikasyonuna Bağlıyan Ürünlerin Müşteriye Göre Edilmesi. Müşteri: Kalite kontrolüne uygun ürünün paketlenmesi. SK: Müşteri istek ve beklentilerine uygun ürün.	Hatazaze ve Müşteri Spesifikasyonuna Bağlıyan Ürünlerin imalatıdır.	Proses kontrol kayıtları arasında yer alan aykırı ölçümler hatazaze raporları ile değerlendirilmelidir.	Aykırı ölçümler üretilen ürünlerde tespit edilmesidir. Müşteri: Ürün gereksinimlerine uygun şekilde paketlenmesi ve taşıma yapılmasıdır.	7	Aykırı ölçümler test bağlamında aykırı ölçümler tespiti yapılmaması.	Tercih arızası	Tercihlerin yanlış kalibrasyonu yapılmamasıdır.	3	Tercihlerin doğrulanması 2 ayda bir defa yapılmasıdır.	6	M	SC

For the press manufacturing process, 15 control parameters have been added to the current control plan.

V. International Applied Statistics Congress (UYIK - 2024)  
Istanbul / Turkey, May 21-23, 2024

Figure 6. Control Plan for the Press Products

No	Name	Work or Operation Description	Machine / Die / Tool	Material Class / Material Name	Characteristics			Special Characteristics Class	Production / Process Specification / Tolerance				Evaluation / Measurement Technique	Methods			Control Method	Maintenance	Record	Action / Reaction Plan	Remarks (Special Process)
					No	Product / Material Characteristics	Process Characteristics		Lower	Target	Upper	Unit		Size	Frequency	Control Responsibility					
50	Skilendirme	S0.3 Damlık Oluşturma ve Tancılığı	Seruc Bilyesi	-	S0.1	-	Seruc Bilyesinde Çatım Homojenliği	SC	Üstün ölçü	Üstün ölçü	Üstün ölçü	mm	100%	Üstün Ölçüm	Üstün Ölçüm	-	-	Üstün Ölçüm Sistemi	-	-	
50	Skilendirme	S0.3 Damlık Oluşturma ve Tancılığı	Seruc Bilyesi	-	S0.2	-	Seruc Bilyesinde Çatım	SC	Üstün ölçü	Üstün ölçü	Üstün ölçü	mm	100%	Üstün Ölçüm	Üstün Ölçüm	-	-	Üstün Ölçüm Sistemi	-	-	
50	Skilendirme	S0.3 Damlık Oluşturma ve Tancılığı	Seruc	-	S0.3	Seruc	-	SC	Üstün ölçü	Üstün ölçü	Üstün ölçü	mm	100%	Üstün Ölçüm	Üstün Ölçüm	-	-	Üstün Ölçüm Sistemi	-	-	
50	Skilendirme	S0.3 Damlık Oluşturma ve Tancılığı	Göbek Serici	-	S0.4	-	Göbek sericinin kalitesi	SC	Üstün ölçü	Üstün ölçü	Üstün ölçü	mm	100%	Üstün Ölçüm	Üstün Ölçüm	-	-	Üstün Ölçüm Sistemi	-	-	
50	Skilendirme	S0.3 Damlık Oluşturma ve Tancılığı	Tıp Flanjesi	-	S0.5	-	Göbek çarpması kontrolü	SC	Üstün ölçü	Üstün ölçü	Üstün ölçü	mm	100%	Üstün Ölçüm	Üstün Ölçüm	-	-	Üstün Ölçüm Sistemi	-	-	
50	Skilendirme	S0.3 Damlık Oluşturma ve Tancılığı	Makas	-	S0.6	-	Makas kırma/yık	SC	Üstün ölçü	Üstün ölçü	Üstün ölçü	mm	100%	Üstün Ölçüm	Üstün Ölçüm	-	-	Üstün Ölçüm Sistemi	-	-	
50	Skilendirme	S0.3 Damlık Oluşturma ve Tancılığı	Oluk	-	S0.7	Oluk Ölçüsü	-	SC	Üstün ölçü	Üstün ölçü	Üstün ölçü	mm	100%	Üstün Ölçüm	Üstün Ölçüm	-	-	Üstün Ölçüm Sistemi	-	-	
50	Skilendirme	S0.3 Damlık Oluşturma ve Tancılığı	Bijeli ç. profil	-	S0.8	Kalıp ç. profilin yaka ölçütleri	-	SC	Üstün ölçü	Üstün ölçü	Üstün ölçü	mm	100%	Üstün Ölçüm	Üstün Ölçüm	-	-	Üstün Ölçüm Sistemi	-	-	
50	Skilendirme	S0.3 Damlık Oluşturma ve Tancılığı	Bijeli Kalp Kulu Mikrometresi	-	S0.9	Kalp kapama balncı ölçütleri uygun olması	-	SC	Üstün ölçü	Üstün ölçü	Üstün ölçü	mm	100%	Üstün Ölçüm	Üstün Ölçüm	-	-	Üstün Ölçüm Sistemi	-	-	
50	Skilendirme	S0.3 Damlık Oluşturma ve Tancılığı	Kalp	-	S0.10	Kalp polijonun uygun olması	-	SC	Üstün ölçü	Üstün ölçü	Üstün ölçü	mm	100%	Üstün Ölçüm	Üstün Ölçüm	-	-	Üstün Ölçüm Sistemi	-	-	
50	Skilendirme	S0.3 Damlık Oluşturma ve Tancılığı	Göbek Mikrometresi	-	S0.11	Göbek mikrometresi doğru ayarlanması	-	SC	Üstün ölçü	Üstün ölçü	Üstün ölçü	mm	100%	Üstün Ölçüm	Üstün Ölçüm	-	-	Üstün Ölçüm Sistemi	-	-	
50	Skilendirme	S0.3 Damlık Oluşturma ve Tancılığı	Kalp Açma Kapama Mikrometresi	-	S0.12	Kalp açma mikrometresi doğru ayarlanması ve ölçü açma ve kalp açma/bakılması için uygun olması	-	SC	Üstün ölçü	Üstün ölçü	Üstün ölçü	mm	100%	Üstün Ölçüm	Üstün Ölçüm	-	-	Üstün Ölçüm Sistemi	-	-	
50	Skilendirme	S0.3 Damlık Oluşturma ve Tancılığı	Kalp Açma Kapama Mikrometresi	-	S0.13	Basılma his kontrolü	-	SC	Üstün ölçü	Üstün ölçü	Üstün ölçü	mm	100%	Üstün Ölçüm	Üstün Ölçüm	-	-	Üstün Ölçüm Sistemi	-	-	

As a result of the 9 Quantitative Gage R&R studies conducted, it was determined that 77% of the measurement systems were adequate, while 23% showed potential for improvement in Measurement System Variation (MSV). Training has been provided to the measurers accordingly.

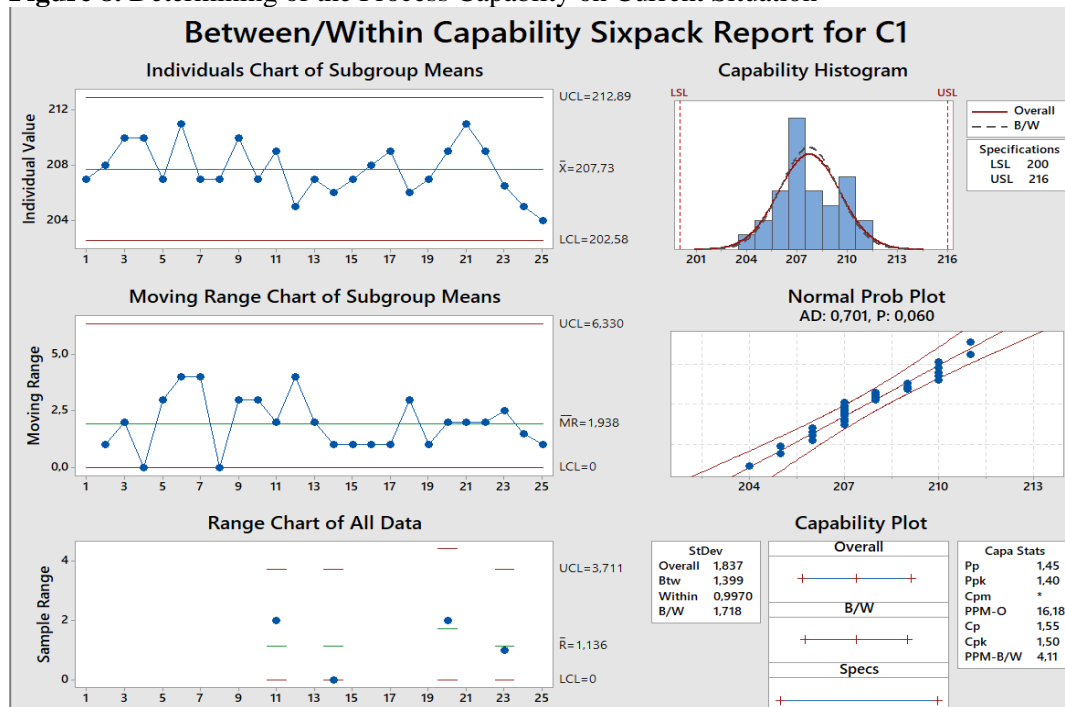
Figure 7. Measurement System Analysis – Gage R&R Sample

MEASUREMENT SYSTEM ANALYSIS - GAGE R&R											Page: 1/2								
Part Number		Gage Name			Appraiser A			Appraiser B			Appraiser C								
10		Weighing Scales			Erşin			Şahin			Yalın								
Part Name		Gage Number			Gage Type			Characteristic			Specification								
440155					Digital			gram			230 ± 13,8								
Machine		Trials		Parts		Appraisers		Date Performed		Notes									
A7 - CCMI - M-026		3		10		3		22.09.2023											
ENTER LOWER TOLERANCE IN U7																			
APPRAISER/ TRIAL #	PART										AVERAGE	Measurement Unit Analysis			% Total Variation (TV)				
	1	2	3	4	5	6	7	8	9	10		Repeatability - Equipment Variation (EV) EV = R x K <sub>1</sub>	Trials	K <sub>1</sub>		% EV = 100 (EV/TV)			
1	224,000	224,000	226,000	227,000	228,000	227,000	226,000	223,000	224,000	226,000	225,600	= 0,000 x 0,5908	2	0,8982	= 100(0,000/0,002)				
2	224,000	224,000	227,000	227,000	228,000	227,000	226,000	223,000	224,000	226,000	225,600								
3	224,000	224,000	226,000	227,000	228,000	227,000	226,000	223,000	224,000	226,000	225,600								
4. AVE	224,00	224,00	226,33	227,00	228,33	227,00	226,00	223,00	224,00	226,00	X <sub>0</sub> = 225,567	= 0,06505	2	0,7071	= 100 (AV/TV)				
5. R	0,000	0,000	1,000	0,000	1,000	0,000	0,000	0,000	0,000	0,000	r <sub>0</sub> = 0,200								
1	224,000	224,000	226,000	227,000	228,000	227,000	226,000	223,000	224,000	226,000	225,600					= 0,15243	3	0,6231	= 100(0,000/0,002)
2	224,000	224,000	226,000	227,000	228,000	227,000	226,000	223,000	224,000	226,000	225,400								
3	224,000	224,000	226,000	227,000	228,000	227,000	226,000	223,000	224,000	226,000	225,400								
7. AVE	224,00	224,00	226,00	227,00	228,00	227,00	226,00	223,00	224,00	226,00	X <sub>0</sub> = 225,433	= 0,005 x 0,3148	2	0,3742	= 100 (PV/TV)				
8. R	0,000	0,000	0,000	0,000	0,000	0,000	0,000	0,000	0,000	0,000	r <sub>0</sub> = 0,200								
9. AVE	224,00	224,00	226,00	227,00	228,00	227,00	226,00	223,00	224,00	226,00	X <sub>0</sub> = 225,467					= 1,60796	3	0,6231	= 100(0,002/0,002)
10. R	0,000	0,000	0,000	0,000	0,000	0,000	0,000	0,000	0,000	0,000	r <sub>0</sub> = 0,200								
11. AVE	224,00	223,87	226,00	227,00	228,00	227,00	226,00	223,00	223,87	226,00	X <sub>0</sub> = 225,467	= 1,60796	4	0,4487	= 99,55				
12. R	0,000	1,000	0,000	0,000	0,000	0,000	0,000	0,000	0,000	0,000	r <sub>0</sub> = 0,300								
13. AVE	224,00	223,87	226,00	227,00	228,00	227,00	226,00	223,00	223,87	226,00	X <sub>0</sub> = 225,467					= 1,60796	5	0,4030	= 100(0,002/0,002)
14. R	0,000	1,000	0,000	0,000	0,000	0,000	0,000	0,000	0,000	0,000	r <sub>0</sub> = 0,300								
15. AVE	224,00	223,87	226,00	227,00	228,00	227,00	226,00	223,00	223,87	226,00	X <sub>0</sub> = 225,467	= 1,60796	6	0,3742	= 99,55				
16. R	0,000	1,000	0,000	0,000	0,000	0,000	0,000	0,000	0,000	0,000	r <sub>0</sub> = 0,300								
17. PART AVERAGE	224,00	223,89	226,11	227,00	228,11	226,89	226,11	223,00	223,89	225,89	X = 225,469					= 1,60796	7	0,3634	= 99,55
18. (f <sub>1</sub> + f <sub>2</sub> + f <sub>3</sub> ) / (# OF APPRAISERS) =											R = 0,2333	= 1,60796	8	0,3375	= 14,8739				
19. X <sub>0.95</sub> = (Max X - Min X) =											X <sub>0.95</sub> = 0,1333								
* UCL <sub>0</sub> = R x D <sub>4</sub> =											UCL <sub>0</sub> = 0,6020								
* D <sub>4</sub> = 3.27 for 2 trials and 2.99 for 3 trials. UCL <sub>0</sub> represents the limit of individual R's. Circle those that are beyond this limit. Identify the cause and correct. Repeat these readings using the same appraiser and unit as originally used or discard values and re-average and recompute R and the limiting value from the remaining observations.													Reason/Planned Action						
Notes:													Evaluation of Results						
													1. %GRR < %10: Acceptable						
													2. %10 ≤ % GRR < %30: May be Acceptable						
													3. %30 < % GRR: Not Acceptable						
													4. ndc > 5 (Not Acceptable), ndc ≤ 5 (Not Acceptable)						

Statistical Process Control applications have generated a dataset of the job weights from the press manufacturing process. The process capability of the tea cup with handle product has been investigated.



Figure 8. Determining of the Process Capability on Current Situation

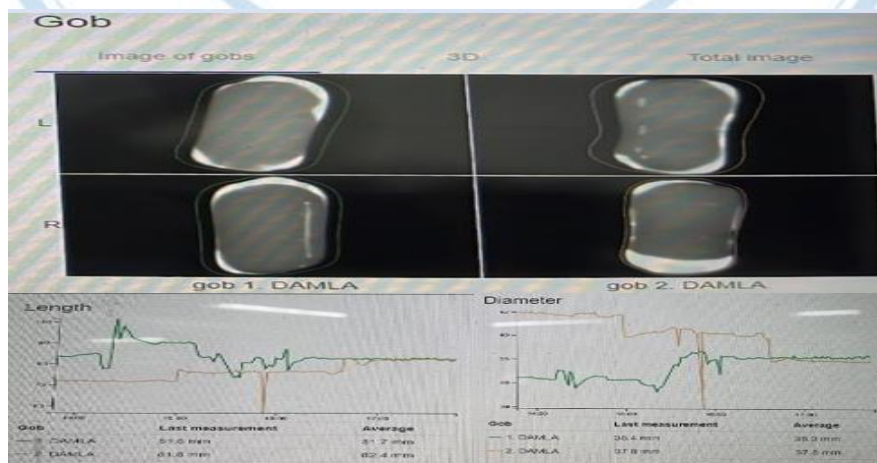


To improve the current situation, a control system integration has been implemented to detect and analyze gob weight and shape. This system utilizes advanced sensor technology and image processing techniques. The goal is to minimize gob weight variations and eliminate weight-related errors.

Weight tracking is performed by measuring the weight of each glass drop using high-precision sensors and image processing technology. These measurements are taken in real-time, ensuring accurate monitoring and recording of weight data.

By adjusting the knife setting, the system automatically adjusts the cutting blade of the production machine in case of weight deviations. This adjustment ensures that each glass drop reaches its optimum weight, thereby enhancing consistency in the production process.

Figure 9. Gob Weight Measurement System Interface



As a result, minimizing weight variations reduces quality losses due to production errors. This leads to fewer errors and higher efficiency in the manufacturing process. Reduced need for manual

interventions also decreases operator errors. The system contributes to cost reduction and enhances customer satisfaction.

The application was initially implemented in the press manufacturing line. In the initial stages, system calibration and testing procedures were conducted. Subsequently, operators were trained, and the system was commissioned. Continuous monitoring and data analysis were performed to evaluate system performance.

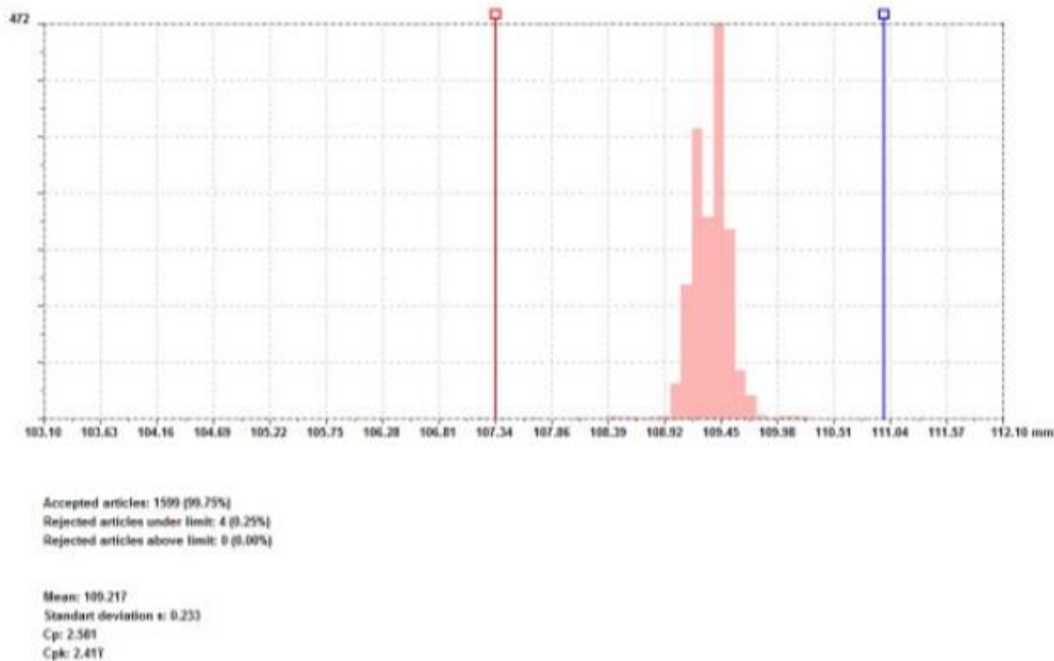
The Drop Weight Measurement System has achieved a 56% improvement in weight deviations, resulting in reduced quality losses related to weight discrepancies.

Efficiency Increase: Following system integration, an increase in production rates has been observed.

Economic Gains: The system has contributed to cost reduction due to decreased quality losses.

The system also determines average, standard deviation, Cp, and Cpk values throughout the production process.

**Figure 10.** Gob Weight Measurement System Statistical Process Control



## DISCUSSION AND CONCLUSION

Following the integration of the Drop Weight Measurement System aimed at eliminating operational errors related to drop weight, a target of reducing weight distribution-related errors by 60% on the press production line has been set.

**Table 4.** Tea Glass with Handle Production Analysis

	Production Data	Unit
Total Production	25.000.000	pcs
Good Production	23.375.000	pcs
Total number of errors	1.625.000	pcs
Error Rate	6,45	%
Number of Errors Due to Weight	889.936	pcs
Number of Defective Products to be Prevented	533.961	pcs
Average Weight per Product	194	gr
Non-Fire Glass	103.588.531	kg
Saving	3.803.770.855	₺

In the glass factory, the defect distribution of products produced through the press manufacturing process has been determined. According to the defect distribution, it was observed that 54.8% of the defects were due to drop weight distribution issues.

A process flow diagram was created for the press manufacturing process, and the process was evaluated for root causes using HTEA (Hazard and Operability Analysis). 56 actions were taken for 125 identified root causes.

The existing control plan was revised based on the conducted HTEA, with 15 parameters added and 6 parameters removed.

Quantitative Gage R&R studies showed that 77% of measurements were reliable, while 23% had opportunities for improvement in Measurement System Variation.

Integration of the Drop Weight Measurement System resulted in a 56% improvement in weight deviations.

Upon repeating the Process Capability Analysis, the Cp value was determined to be 2.11 and the Cpk value was 1.61.

Approximately 3,800,000 ₺/year in savings is targeted to be achieved from just one production line.

## References

- Bhattacharjee, P., Dey V., Mandal U.K., (2022) Failure Mode and Effects Analysis (FMEA) using interval number based BWM—MCDM approach: Risk Expected Value (REV) method. *Soft Computing*.
- Gupta, N., Singh, R., (2015). Bir üretim sürecinin kalitesini artırmak için FMEA uygulaması. *International Journal of Engineering Research and General Science*, 3(3), 1210-1216.
- Li H., Diaz H., Soares C.G., (2021) A developed failure mode and effect analysis for floating offshore wind turbine support structures. *Renewable Energy*
- Liu, H., Chen X., Duan C., Wang Y., (2019) Failure mode and effect analysis using multi-criteria decision making methods: A systematic literature review. *Computer&Industrial Engineering*.
- Stamatis, D. H., (2011). *Failure Mode and Effect Analysis: FMEA from Theory to Execution*. ASQ Quality Press.
- von Ahsen, A., Petruschke L. & Frick N., (2022). Sustainability Failure Mode and Effects Analysis - A systematic literature review. *Cleaner Production*.
- Yaman, N., Burunkaya, M., (2021). Uydu Ekipman Tasarımında Yeni Bir Hibrit Hata Türü Etkileri VE Kritiklik Analizi (HTEKA) Yaklaşımı. *Journal of Polytechnic*.
- AIAG&VDA, 2019. Hata Türleri ve Etkileri Analizi FMEA El Kitabı. 1.Baskı, AIAG Yayınları, USA
- Burnak N., Aktar Demirtaş E., 2019. Toplam Kalite Yönetiminde İstatistiksel Süreç Kontrolü. ESOGÜ Basımevi, 221, Türkiye
- Erginel N., 2020. Kalite Mühendisleri İçin El Kitabı. 1. Basım, Nobel Yayıncılık, Türkiye.



## Implementing Artificial Intelligence in Agriculture: The case of Albanian Farmers

**Marsela Luarasi**<sup>1\*</sup>

<sup>1</sup>Agricultural University of Tirana, Faculty of Forestry Sciences, Department of Forestry, Tirana, Albania

\*Corresponding author e-mail: mluarasi@ubt.edu.al

### ***Abstract***

*This research paper outlines a complete and current investigation on the implementation of Artificial Intelligence techniques in agriculture and its importance in today's markets. Food and Agriculture Organisation, the most important agency of the United Nations when it comes to food security emphasizes the fact that by 2050 the planet Earth will increase by 2 billion of newborns, whereas the land where food is grown and cultivated will be only increased by 5% during this time.*

*Given these facts and being in such challenging times the use of latest technological know-how is becoming more important than ever in order to make agriculture and farming less costly, more efficient. A straightforward approach when it comes to AI implementation across this sector could be fairly beneficial for the sector and also could change the way how farming is practiced and managed nowadays in Albania. By using artificial intelligence, we can bring in life smart and precise farming techniques that not only can minimize the loss of farmers but also could improve massively their productivity and process efficiency.*

*Artificial Intelligence can put into work different solutions for farming and this can help a farmer to do more with less resources, thus enhancing the quality of the farmers' products, improving their costs, productivity and also accelerating their market reach.*

*The current paper throws a vision of how the diverse sectors of agriculture can be revived by using different innovations in artificial intelligence. This paper also looks at what the future of agriculture is in Albania and at some of the challenges that farmers face in their day-to-day operations. A survey was conducted on 200 small and medium-scale farmers in Shkodra and Lezha regions, capturing valuable insights and feedback on the use of AI in farming practices.*

**Keywords:** Agriculture, Artificial Intelligence, Robo Farming, Precise, Smart Farming.

### **1. INTRODUCTION**

By the year 2050, it is projected that the global population will reach nearly 10 billion. This substantial increase in population will have a significant impact on the agricultural sector, which is expected to experience a 50% growth compared to its state in 2013, despite modest financial development (FAO, 2022). Currently, approximately 37.7% of the Earth's land surface is dedicated to crop production. Agriculture plays a crucial role in various aspects, ranging from job creation to contributing to the national income. Developed nations greatly benefit from the economic prosperity brought about by agriculture, while developing countries also rely on it as a vital component of their economies. The expansion of the agricultural sector has notably improved the per-capita income of rural communities. Therefore, it is both logical and appropriate to prioritize and invest in the agricultural sector. In countries like Albania, agriculture accounts for 23% of the GDP and employs 30% of the workforce. Advancements in this sector will not only enhance rural development but also pave the way for rural transformation, ultimately leading to structural transformation. (FAO, 2022)

Artificial Intelligence plays a crucial role in the field of computer science due to its rapid technological progress and wide range of applications. Agriculture stands out as a sector where AI is particularly essential. (Alexandratos and Bruinsma, 2012) Agriculture is typically a primary occupation that demands significant effort, perseverance, and persistence, often resulting in low income and an uncomfortable lifestyle for farmers. The hard work involved in cultivating suitable crops is time-consuming, leading farmers to rely on agriculture as their main source of income. However, factors such as poor yields due to weather conditions or resource scarcity can result in financial losses, pushing farmers into depression and, tragically, suicide. (Javoid et al, 2022) A key contributing factor to this issue is the failure to identify a suitable secondary occupation that is less time-consuming and energy-draining. AI technology in agriculture can address these critical challenges by reducing time requirements and minimizing physical labor. By leveraging AI effectively, farmers can achieve higher yields through uniform planting and optimal crop growth, ultimately improving their quality of life. Furthermore, AI in agriculture can assist farmers in diversifying their income sources, thereby boosting their morale and preventing mental health issues. (Maffezoli et al, 2022) To further explore the potential of AI in agriculture, a survey was conducted on 200 small and medium-scale farmers in Shkodra and Lezha regions, capturing valuable insights and feedback on the use of AI in farming practices.

## **2. APPLICATIONS OF ARTIFICIAL INTELLIGENCE IN AGRICULTURE**

Artificial Intelligence (AI) has the potential to revolutionize various fields and bring about a significant change in the way farming is perceived today. By harnessing the power of AI, farmers can not only optimize their resources but also increase their yield. This is in line with the growing trend of utilizing advanced technologies in different aspects of our lives, including education, healthcare, and governance. Among these sectors, agriculture stands out as a particularly promising domain for AI implementation due to its focus on efficiency and smart working practices. (Hemathilake and Gunathilake, 2022) Integrating AI into agricultural practices can be achieved at a low cost and with ease. AI can effectively address a range of agricultural challenges within a short span of time. Techniques such as improving harvesting quality and introducing indoor farming can be employed through AI to enhance crop production rates.

AI has numerous applications that can genuinely assist farmers in various ways. One such application involves the analysis of farm data, which can greatly enhance the quality and accuracy of crops. By utilizing AI sensors, farmers can effectively target and detect weeds, as well as identify diseases in plants and pests. (Bertoglio et al, 2021) Additionally, AI plays a crucial role in addressing labor challenges faced by farmers. With fewer individuals entering the agricultural profession, farmers often encounter workforce shortages and a lack of manpower. To combat this issue, agriculture bots have been introduced to work alongside farmers. These bots are capable of harvesting crops at a higher volume and with increased speed. Notably, there are specific agricultural robots, such as those developed by Blue River Technology, that are designed for weed control. (Idoje et al, 2021) Another example is Harvest CROO Robotics, which specializes in crop harvesting. Furthermore, robotics has made significant advancements by creating robots that can efficiently pick and pack crops, providing further assistance to farmers.

AI plays a crucial role in agricultural practices, providing diagnostic analysis similar to satellites used for weather prediction and crop sustainability. This technology can greatly benefit farmers who are aware of impending weather changes. (Bogomolev et al, 2021) Another innovative AI technique is the use of driverless tractors, which operate autonomously without the need for human presence inside the vehicle, thereby reducing the workload for farmers. Additionally, Farmer's Alexa is an intriguing technology that allows farmers to interact with a virtual assistant similar to chatbots, assisting them in solving complex problems. Aerial crop spraying, crop monitoring using drones is another advancement

that significantly speeds up the process, being five times faster than traditional machinery. (Musa and Basir, 2021) Furthermore, the introduction of agri-E-Calculator in AI for farming is a smart application that aids farmers in selecting suitable and cost-effective crops by calculating their prices.

By leveraging AI effectively, farmers can achieve higher yields through uniform planting and optimal crop growth, ultimately improving their quality of life. Furthermore, AI in agriculture can assist farmers in diversifying their income sources, thereby boosting their morale and preventing mental health issues. (Magasumovna et al, 2017)

There is a wide array of applications available in the market; however, the main issue lies in their high cost and complex manual. In simpler terms, the integration of AI in Agriculture enables farmers across the globe to operate with greater efficiency. It is projected that by 2025, farmers will be utilizing 100 million interconnected devices, and by 2040, an average smart farm is expected to generate around 1.8 million data points daily. (Kassanuk and Phasinan, 2022)

To further explore the potential of AI in agriculture, a survey was conducted on 200 small and medium-scale farmers in the Shkodra and Lezha regions, capturing valuable insights and feedback on the use of AI in farming practices.

### **2.1. Precise Agriculture in Real Time Soil Monitoring**

Precision agriculture is a cutting-edge approach that enables farmers to optimize crop production by utilizing advanced technology and data analysis tools. This innovative concept has gained global recognition as it offers numerous benefits, including increased yields, reduced labor requirements, and improved management of fertilizers and irrigation processes. (Oliveira et al. 2023) By harnessing a wealth of data and information, precision agriculture enhances the efficient utilization of agricultural resources, resulting in higher crop yields and improved crop quality. It is a sophisticated and strategic field-level management strategy that aims to maximize the productivity of agricultural resources. Through precision agriculture, farmers can provide tailored inputs such as water and fertilizer to enhance productivity, quality, and overall yield. (Javaid et al, 2022) Regardless of the data source, the primary objective of precision agriculture is to empower farmers with the necessary support and tools to effectively manage their agricultural operations.

## **3. MATERIALS AND METHODS**

### **3.1. The Case Study Area**

Agriculture in Albania is widely recognized as a sector of high potential when it comes to implementing the smart farming techniques and artificial intelligence. Accounting for 23% of the country's GDP, it serves as the primary source of livelihood for the rural populace. Despite witnessing gradual expansion in recent years, the sector faces significant obstacles in the form of inadequate infrastructure and inefficient irrigation systems, impeding its overall progress.

Shkodra and Lezha, along with the rest of Albania, are situated in the Mediterranean climate zone and exhibit distinct Mediterranean characteristics. These regions experience hot and dry summers with abundant sunshine, as well as mild winters accompanied by heavy rainfall. Frost and snow are exceptionally rare phenomena. The onset of heat begins in the middle of spring and persists until the end of October. The warm climate in these areas is attributed to the influence of the sea, river, and lake, which contribute to the overall moisture content. Shkodra particularly stands out for its high number of sunny days, averaging around 2600 hours annually. Rainfall patterns in these regions are highly irregular, with the majority occurring during the colder months. On average, the annual precipitation amounts to 980-1000 mm. Summers are characterized by dry spells, often lasting for weeks without rain. The wettest months are November, January, and February, while July and August are the driest.



Due to their proximity to the sea, the climate remains mild, and temperatures rarely drop below freezing. The average annual temperature ranges from 16 to 18°C. The favorable climate of Shkodra and Lezha enables the development of smart farming and agriculture, with the added advantage of being able to utilize agricultural lands twice a year.

### 3.2 The Collection of the Data

A structured survey questionnaire and face-to-face interviews were utilized to gather data from consumers in the Shkoder and Lezha regions. The study involved the participation of 200 small and medium scale farmers, with an equal distribution between the two farm sizes. The selection of farmers was conducted in collaboration with local entities in the region, ensuring a meticulous process. With a sample size of 200, the study guarantees a dependable representation of the opinions and attitudes towards AI in agriculture among small and medium scale farmers in these two very interesting and potential regions.

### 3.3 Data Statistical Analyses

In this research descriptive statistics were employed. By employing descriptive statistics, researchers can effectively summarize and communicate the key characteristics of a dataset, facilitating a better understanding of the data and providing a foundation for further statistical analysis or decision-making processes. Descriptive statistics summarize and organize characteristics of a data set. A data set is a collection of responses or observations from a sample or entire population.

Descriptive statistics also involves a graphical representation of data through charts, graphs, and tables, which can further aid in visualizing and interpreting the information. Common graphical techniques include histograms, bar charts, pie charts, scatter plots, and box plots.

The primary goal of descriptive statistics is to provide a clear and concise summary of the data, enabling researchers or analysts to gain insights and understand patterns, trends, and distributions within the dataset.

## 4. SURVEY RESULTS

The survey which was conducted received a great response by the farmers' community. Two hundred small and medium scale farmers responded and reviewed it together with the interviewing staff members. According to the survey five questions related to the AI implementation in agriculture were asked to the farmers. The researcher was very much interested to know the following: farmers' attitude on acceptance and usage of AI technology; precise farming; factors that affect this acceptance and usage of AI; farmers' readiness to implement AI in their farm; top three AI applications to implement in their farm.

*A) Do you agree that the usage of AI Technology in agriculture can bring a positive change in your traditional/conventional old farming methods?*

As we can analyse from the chart, 60% of the farmers responded to this question fully agree that the usage of AI technology in agriculture is going to benefit to them and will bring a positive change when comparing with the old farming methods. 29% of the farmers only partially agree with this statement, whereas 9% of them were declared neutral as they did not know a lot about this topic. Only a small minority of farmers (2%) did not agree with this statement and when asked to elaborate more they just believed that it is too early for Albania to think of AI usage and AI adaptation in agriculture.

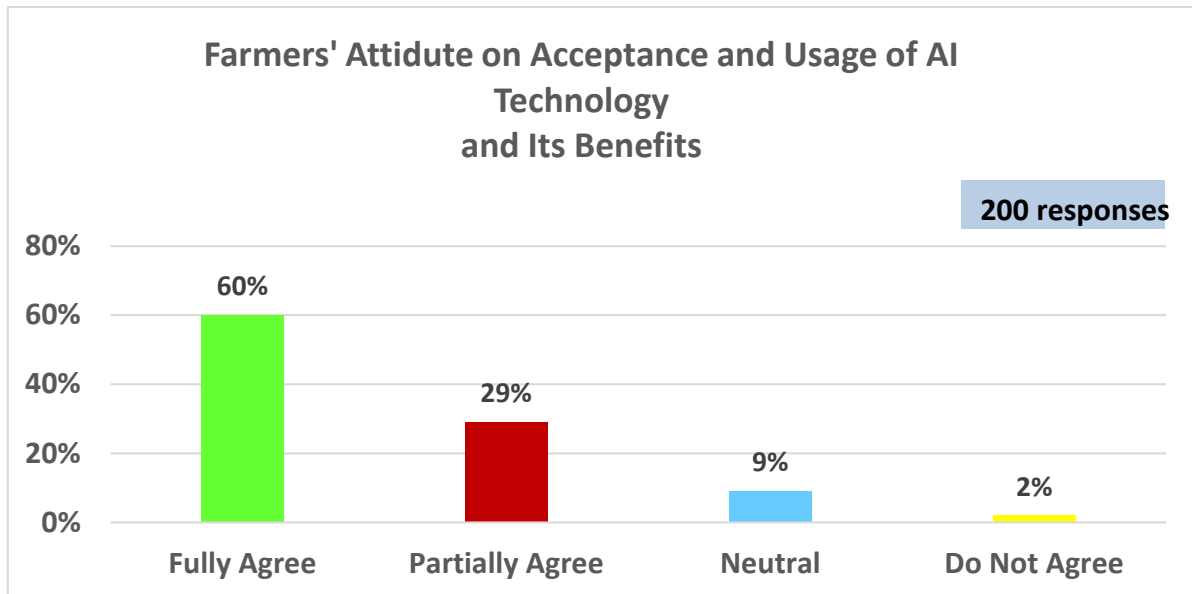


Figure 1

B) Do you agree that the usage of Precise Agriculture Technology (Precise Farming) can bring an improvement to your harvest products in terms of quality and quantity?

When asked about the precise farming it is interesting to note that 52% of the farmers agree fully that it will bring benefits for them, whereas 26% of them believe that they can only partially benefit from the precise farming AI technology. 16% of the farmers responded that they are neutral as they neither believed in the benefits of precise agriculture nor in the pitfalls of it. The group of farmers that did not agree at all that precise farming would bring any benefit for them stood for 7%, a higher figure actually than in the first question.

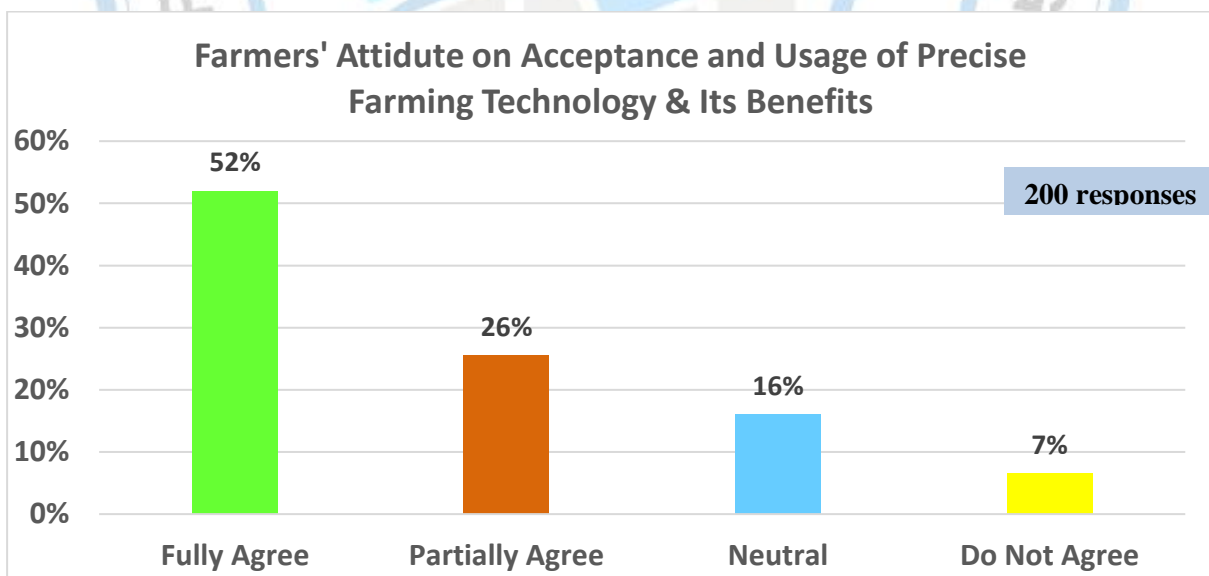


Figure 2

C) For small and medium scale agricultural farms, what are the main factors that can hinder the early adoption and usage of AI technology?

In this question it is interesting to see that 39% of the respondents choose the potentially high price of AI service as a determinant factor that will affect their acceptance and usage of AI technology in

farming. Together with the other factor that is the difficult adaption of technology they make a barrier of 65% for the farmers.

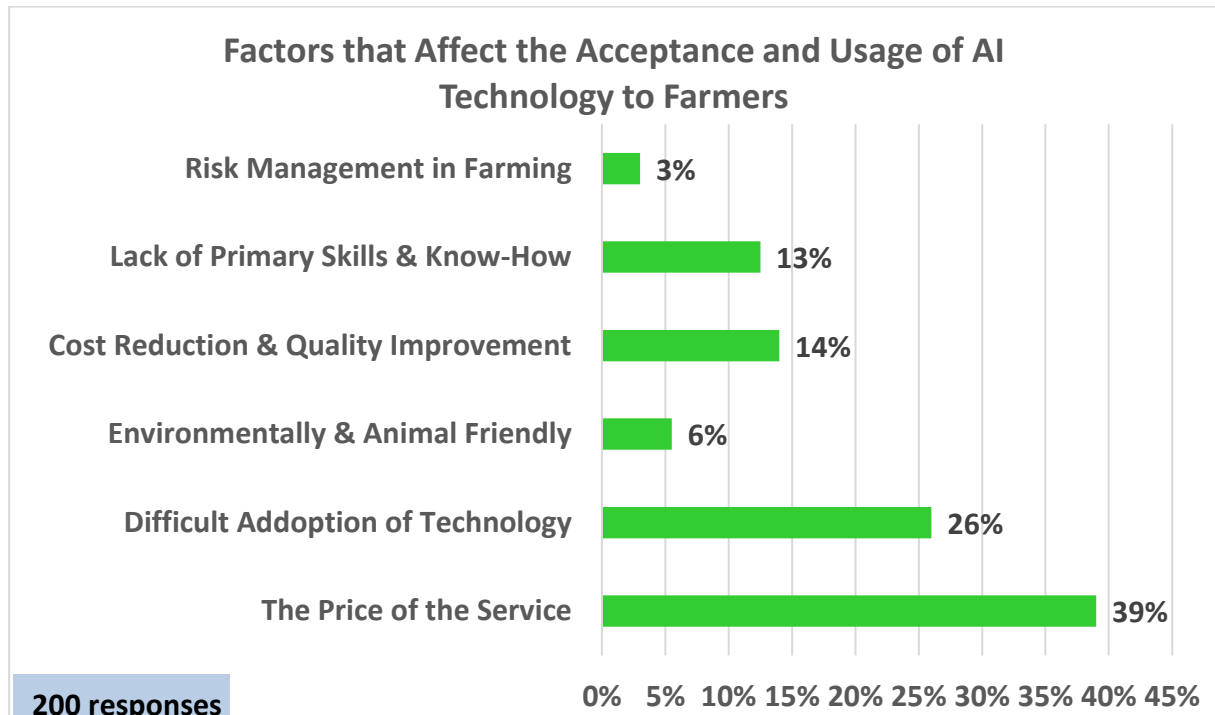


Figure 3

D) How ready do you feel to implement the usage of AI technology in your farm?

When it comes to the readiness of the farmers to implement the AI technology in their farms, surprisingly only 17% were fully ready and 26% were partially ready. The biggest number of farmers asked were neutral, a data representing 39% of the group and 19% were not ready at all, a figure higher than the fully ready group.

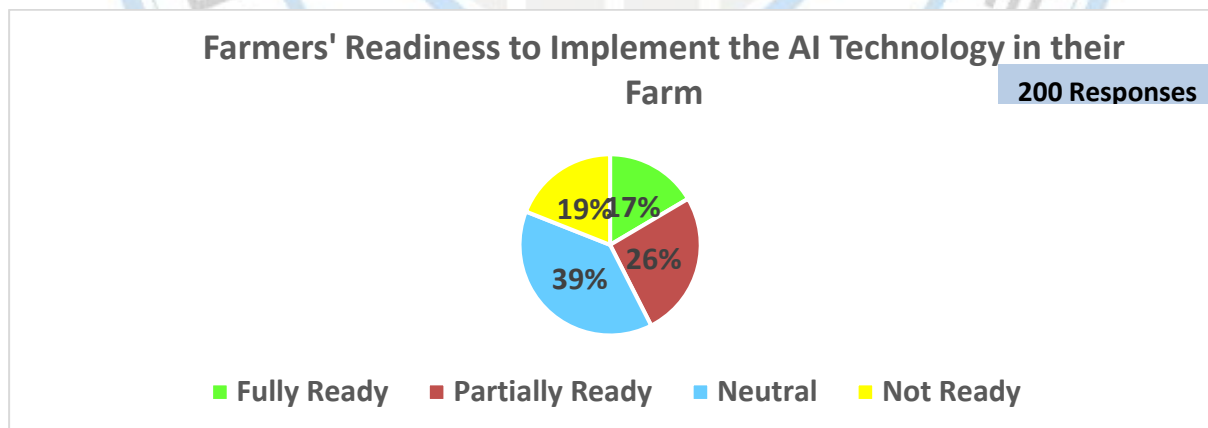


Figure 4

E) From the list given to you, can you please the top three AI solutions that you would use in your farm?

When asked that which AI applications they would consider to use in their farm, the following top three applications were more popular and prone to be used by the farmers. It is interesting to see that they want to use Real time monitoring for their soil health. This particular service application is the top picked service by the farmers with 25 %, followed by drone for monitoring with 24% and then drone



for spraying with 14%. The bottom services needed for them were drones for fires and chatbot farmer assistants with 10 and 4% respectively.

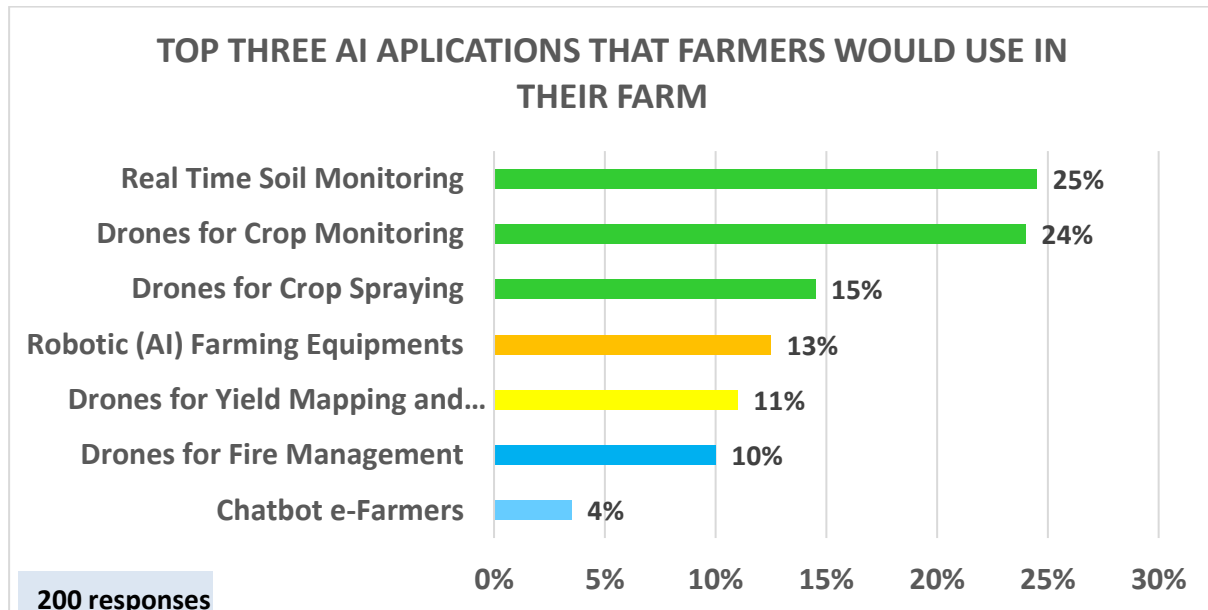


Figure 5

## 5. DISCUSSION & CONCLUSION

Agricultural production experienced a threefold increase between 1960 and 2015, coinciding with the global population's growth from 3 billion to 7 billion individuals. (FAO, 2022) While the utilization of technology, such as pesticides, fertilizers, and machinery, played a significant role in this achievement, a substantial portion of the progress can be attributed to the expansion of cultivated land through deforestation and the diversion of freshwater to fields, orchards, and rice paddies. As we move forward, it is imperative that we adopt a more resourceful approach. The advent of artificial intelligence (AI) is expected to revolutionize agriculture and the market in the coming years. This technology has proven beneficial for farmers as it enables them to comprehend various hybrid cultivation methods that can yield higher incomes within a limited timeframe. By effectively implementing AI in agriculture, the cultivation process can be enhanced, ultimately creating a favorable environment for the market. However, farmers must adapt to the changing landscape and embrace digital transformation in agriculture through the integration of AI. This is just one example of how AI is reshaping agriculture, an emerging trend that will undoubtedly catalyze an agricultural revolution. Thus, it is crucial that we approach this new era with increased resourcefulness.

Agriculture has encountered numerous challenges such as the lack of irrigation systems, fluctuations in temperature, limited groundwater resources, food scarcity, and wastage, among others. The future of farming heavily relies on the adoption of various cognitive solutions. Although extensive research is still ongoing and some applications are already accessible in the market, the agricultural industry remains largely underserved. Despite the potential of autonomous decision-making and predictive solutions to address practical challenges faced by farmers, the implementation of such technologies is still in its early stages. To fully explore the vast potential of artificial intelligence (AI) in agriculture, applications must be more robust. Only then can they effectively adapt to frequent changes in external conditions, enable real-time decision-making, and utilize an appropriate framework or platform to efficiently collect contextual data. Additionally, the high cost of existing cognitive solutions for farming poses a significant barrier. To ensure widespread adoption among farmers, these solutions need to

become more affordable. The availability of an open-source platform would enhance affordability, leading to rapid adoption and greater penetration in the farming community. Ultimately, this technology will prove invaluable in assisting farmers in achieving higher yields and cultivating better seasonal crops at regular intervals. (Bertoglio et al, 2021)

However, technology can enhance performance and effectively address these issues. Various AI-driven techniques, such as utilizing remote sensors to detect soil moisture content and implementing automated irrigation systems with GPS assistance, can significantly improve agricultural outcomes. (Maffezzoli et al, 2022) One of the challenges faced by farmers is the loss of a substantial amount of crops during the weeding process, which can be overcome by employing precision weeding techniques. These autonomous robots not only enhance efficiency but also minimize the reliance on unnecessary pesticides and herbicides. Additionally, farmers can efficiently spray pesticides and herbicides on their farms using drones, while plant monitoring is no longer a cumbersome task.

## 6. References

- FAO. The State of Food Security and Nutrition in the World 2022; FAO: Rome, Italy, 2022; ISBN 978-92-5-136499-4
- Alexandratos, N.; Bruinsma, J. World Agriculture Towards 2030/2050: The 2012 Revision 2012; FAO: Rome, Italy, 2012
- Javaid, M.; Haleem, A.; Khan, I.H.; Suman, R. Understanding the potential applications of artificial intelligence in agriculture sector. *Adv. Agrochem.* 2022, 2, S277323712200020X
- Maffezzoli, F.; Ardolino, M.; Bacchetti, A.; Perona, M.; Renga, F. Agriculture 4.0: A systematic literature review on the paradigm, technologies and benefits. *Futures* 2022, 142, 102998
- Hemathilake, D.M.K.S.; Gunathilake, D.M.C.C. High-Productive agricultural technologies to fulfill future food demands: Hydroponics, aquaponics, and precision/smart agriculture. In *Future Foods*; Elsevier: Amsterdam, The Netherlands, 2022; pp. 555–567. ISBN 978-0-323-91001-9
- Bertoglio, R.; Corbo, C.; Renga, F.M.; Matteucci, M. The digital agricultural revolution: A bibliometric analysis literature review. *IEEE Access* 2021, 9, 134762–134782
- Idoje, G.; Dagiuklas, T.; Iqbal, M. Survey for smart farming technologies: Challenges and issues. *Comput. Electr. Eng.* 2021, 92, 107104
- Bogomolov, A., Nevezhin, V., Larionova, M. and Piskun, E. (2021), “Review of digital technologies in agriculture as a factor that removes the growth limits to human civilization”, *E3S Web of Conferences*, Vol. 247, doi: 10.1051/e3sconf/202124701074.
- Kassanuk, T. and Phasinam, K. (2022), “Impact of internet of things and machine learning in smart agriculture”, *ECS Transactions*, Vol. 107 No. 1, p. 3215.
- Magasumovna, A.A., Anasovna, S.G. and Alfirovna, Z.Z. (2017), “Factors and reserves of increase of efficiency of agricultural production”, *International Journal of Applied Engineering Research*, Vol. 12 No. 24, pp. 15821-15829
- Musa, S.F.P.D. and Basir, K.H. (2021), “Smart farming: towards a sustainable agri-food system”, *British Food Journal*, Vol. 123 No. 9, pp. 3085-3099
- Oliveira, R.C.d.; Silva, R.D.d.S.e. Artificial Intelligence in Agriculture: Benefits, Challenges, and Trends. *Appl. Sci.* 2023, 13, 7405. <https://doi.org/10.3390/app13137405>

## Rize İlinde Çay Üretiminde Karşılaşılan Bitki Koruma Sorunlarının Belirlenmesi

İnci YÜKSEK<sup>1</sup>, Dürdane YANAR<sup>1\*</sup>, Esen ORUÇ<sup>2</sup>, Yalçın TAHTALI<sup>3</sup>, Yusuf YANAR<sup>1</sup>

<sup>1</sup>Tokat Gaziosmanpaşa Üniversitesi, Ziraat Fakültesi, Bitki Koruma Bölümü, 60240, Tokat, Türkiye

<sup>2</sup>Tokat Gaziosmanpaşa Üniversitesi, Ziraat Fakültesi, Tarım Ekonomisi Bölümü, 60240, Tokat, Türkiye

<sup>3</sup>Tokat Gaziosmanpaşa Üniversitesi, Ziraat Fakültesi, Zootekni Bölümü, 60240, Tokat, Türkiye

\*Sorumlu yazar e-mail: [durdane.yanar@gop.edu.tr](mailto:durdane.yanar@gop.edu.tr)

### Özet

*Bu araştırma çay üretiminin yoğun olarak gerçekleştirildiği Rize ilinin Merkez, Çayeli, Pazar, Ardeşen ilçelerinde çay üreticilerinin çaylıklarda karşılaştığı bitki koruma sorunlarının belirlenmesi, belirlenen bu sorunlara karşı üreticilerin uyguladıkları bitki koruma yöntemlerinin ortaya konması amacıyla gerçekleştirilmiştir. Çalışma anket çalışması verilerine dayalı bir alan araştırmasıdır. Araştırma alanı olarak belirlenen dört ilçede toplam 320 adet anket görüşmesi yapılmıştır. Araştırma sonuçlarına göre çay üreticilerinin genel olarak önemli düzeyde zarar oluşturan herhangi bir bitki koruma sorunu olmadığı ancak son yıllarda iki zararlının bölgede çay üretimini tehdit etmeye başladığı belirlenmiştir. Bu zararlılardan birisi Gürcistandan ülkemize girdiği belirlenen vampir kelebek (*Ricania simulans*), diğeri ise kahverengi kokarcadır (*Halyomorpha halys*). Elde edilen bulgular bölge üreticilerinin bilinçlendirilmelerinin önemini ortaya koymaktadır. Üreticilere yönelik toplantılar ve eğitimlerle üreticinin bilinçlendirilmesi sağlanmalıdır.*

**Keywords:** Bitki Koruma Sorunları, Anket, Çay, Rize, Organik tarım

### Abstract

*Survey was conducted to determine the plant protection problems encountered during tea production, plant protection practices used to deal with these problems and approach to organic production by tea producers in Central, Çayeli, Pazar, and Ardeşen districts of Rize. Total of 320 farmers participated to the survey. According to the results of the survey, it has been determined that the tea producers generally do not have an important plant protection problem, however two important pests threaten tea production in the region in recent years. One of these pests is the vampire butterfly (*Ricania simulans*), which was determined to have entered our country from Georgia. The other is the brown marmorated stink bug (*Halyomorpha halys*). The findings reveal the importance of raising the awareness of regional producers. The awareness of the producers should be raised through meetings and trainings for the producers.*

**Key words:** Plant Protection Issues, Questionnaire, Tea, Rize, Organic farming

### GİRİŞ

Çay, *Theacea* familyasının *Camellia* cinsine ait dört mevsim yeşil kalabilen, çok yıllık bir bitkidir. *Camellia sinensis* (L.) O. Kuntze 'nin; Çin çayı ve Assam çayı olmak üzere 2 varyetesi bulunmaktadır (Elmas ve Gezer, 2018). Türkiye'de yetiştirilip üretimi sağlanan çaylar genellikle saf olmayıp karışık melezler formundadır. Sovyetler Birliği'nden getirilip Türkiye'de halen tarımı yapılan çay bitkilerinin *Thea sinensis* var. *assamica* X *Thea sinensis* var. *sinensis* melezleri olduğu bildirilmiştir (Demir, 2002). Türkiye'de var olan çay üretim arazileri 764 bin dekar olarak hesaplanmıştır. Türkiye, dünya çay üretim arazilerinin % 2'sini oluşturduğu bildirilen Doğu Karadeniz Bölgesi'ndeki çaylıklarıyla dünya genelinde 8. sırada bulunmaktadır. Türkiye'de çay üretiminin % 68,6'sı (905,6 bin ton) Rize'de, % 19,1'i (271,6 bin ton) Trabzon'da, % 16,9'u (141,4 bin ton) Artvin'de ve % 3,8'i de (32,1 bin ton) Giresun'da gerçekleştirilmektedir (Dündar, 2016).



Çakır ve Ceylan (1987), Türkiye’de Doğu Karadeniz bölgesinde çaylıklarda hastalık meydana getiren etmenleri belirlemişlerdir. Çayın yaprak kısımlarında *Guignardia camelliae* (Cooke), *Colletotrichum camelliae* Masee, *Pestalotia theae*, *Phyllosticta* sp., *Cercoseptoria theae* Breda de Haan, dallarda *Pestalotia theae*, *Phoma* sp., dal ve yapraklarda siyah fumajin (*Capnodium* sp.), sarı fumajin, yıllık sürgün yapraklarında kloroz, yapraklarda ödem hastalıkları, dal ve gövdelerde ayrıca büyük ihtimalle *Hypodermopsis theae* olduğu düşünülen bir fungusun zarar meydana getirdiğini bildirmişlerdir. Bu funguslardan başka; *Monochaetia natrasii*, *Fusarium* spp. ve *Trichothecium* sp. fungus türlerinin de çalışma neticesinde tespit edildiği bildirilmektedir.

Bozan ve ark.(1972) Karadeniz Bölgesi’nde, Çay koşnilinin (*Pulvinaria floccifera* (Westw.)) büyük ölçüde zarara sebep olduğu bildirilmiştir. *Polyphagotarsonemus latus* (Banks) (Sarı çay akarı) zararlısı da çayda özellikle uç kısımlarda bulunan sürgün ve taze yapraklarda zarar oluşturmaktadır. Sözü edilen zararlının beslenmesi sonucunda çay yaprağı kimyasal bileşiminde değişiklikler meydana gelmesi nedeniyle oluşan zararlanma sonucu, çay yaprağında bulunan kalite bileşenlerinin miktarında ve verimde farklılıklar meydana geldiği gözlemlenmiştir (Çuhadar, 2015).

Göktürk ve Mıhlı (2015), *Ricania simulans* (Walker, 1851) (Hemiptera: Ricaniidae) , Doğu Karadeniz bölgesi kıyı hattı boyunca 2006 yılı itibariyle özellikle tarım alanlarında zarar verdiği bildirilmiştir. Vampir kelebek olarak da bilinen bu türle mücadele konusunda yoğun bir çalışma yapılmadığı için yayılışını devam ettirmekte olduğu bildirilmektedir. Bu çalışma da özellikle böceğin yoğun olarak görüldüğü Artvin ilinde bulunan tarım arazilerinde ışık ve yapışkan tuzaklar kullanılmak suretiyle böceğin erginlerinin yoğunlukları düşürülmeye çalışılmıştır. Kurulan tuzaklara çalışma sonucunda bakılıp yakalanan böcek sayıları baz alınarak bir analizleme işlemi yapılmıştır. Bu işlem sonucunda kurulan ışık tuzaklarında yapışkan tuzaklara göre çok daha fazla böcek sayısı tespit edilmiştir. Çalışma bize bu zararlı türe karşı mücadelede ışık tuzaklarının etkili olduğunu göstermiş ve bu sebeple alternatif olarak kullanılabileceğini bildirmişlerdir. Ak ve ark.(2015), tarafından 2009-2011 yıllarında Türkiye’de çay üretim alanlarında zararlı olan *Ricania simulans* (Walker) (Hemiptera: Ricaniidae)’ın yayılışını, konukçularını ve biyolojisini belirlemek amacıyla yürütülmüş olan bu çalışmada, zararlı türün özellikle çayın yoğun olarak üretildiği Rize ili ve çevresinde yayılım göstermeye devam ettiği tespit edilmiştir. Özellikle zararlının nimf ve erginlerinin çok sayıda kültür ve yabancı bitkide zarar meydana getirdiği ve yoğunluklarının da her geçen gün artış gösterdiği yapılan incelemeler sonucunda ortaya konmuştur. Bu çalışmanın neticesinde *R. simulans*’ın Doğu Karadeniz Bölgesi kıyı kuşağının neredeyse tamamına yakınında yayılma gösterdiği bildirilmiştir. Bu türün başlıca konukçuları arasında çay bitkisinin de olduğu bildirilmiştir.

*Halyomorpha halys* (Stål) (Kahverengi kokarca) ilk olarak 2017 yılında Doğu Karadeniz Bölgesi'nde (Artvin civarında) saptanmış olup daha sonraları Rize’de de görülmeye başlamıştır. Kahverengi kokarca (*Halyomorpha halys*), tarımsal üretimde önemli ölçüde kayıplara neden olan istilacı ve polifag bir zararlı olup çay üretim alanlarında da görülmektedir (Özdemir ve Tuncer,2021; Ak ve ark., 2023).

Bu çalışmada Rize ilinde çayın yoğun olarak yetiştirildiği Merkez, Ardeşen, Çayeli ve Pazar ilçelerinde bitki koruma sorunlarının ve üreticilerin söz konusu sorunlarla mücadele yöntemlerinin ortaya konması amaçlanmıştır.

## MATERYAL VE YÖNTEM

### Materyal

Bu çalışma 2020-2021 yıllarında yürütülmüştür. Bu çalışmanın ana materyalini, 320 üretici ile yüz yüze gerçekleştirilen anket çalışmasından elde edilen veriler oluşturmuştur. Araştırma materyali, bunlara ek olarak ikincil verilerle de desteklenmiştir. Çay Araştırma Enstitüsü ve Rize İl Tarım ve Orman Müdürlüğü kayıtlarından yararlanılmıştır.

## Yöntem

### Örnekleme ve Anketlerin Yapımı Kısımında Uygulanan Yöntem

Araştırma kapsamında yer alan Rize ilinin tamamında yoğun bir şekilde çay üretimi yapılmaktadır. Araştırmada anket çalışmasının gerçekleştirileceği araştırma alanı ve örnek hacminin belirlenmesi amacıyla, TÜİK verilerinden yararlanılmıştır. Bu aşamada Çaykur'la yapılan görüşmelerden de yola çıkılarak, üretilen çayın ve çay alanlarının yaklaşık üçte ikisinin gerçekleştirildiği dört ilçe (Merkez, Ardeşen, Çayeli ve Pazar) araştırma alanı olarak belirlenmiştir. Örnekleme çalışması kapsamında belirlenen araştırma alanındaki dört ilçeye bağlı köylerin%2'siyle çalışılması uygun bulunmuştur. Dört ilçedeki köy sayısının %2'si 10 köye tekabül etmektedir. Belirlenen köy sayısı (10 köy) dört ilçeye, köy sayısı yoğunluğuna göre 3-3-2-2 olarak dağıtıldı. Köylerin hangileri olacağı, köylerdeki çay üreticisi işletme sayısına göre belirlenmiştir. En fazla işletmenin yer aldığı köyler araştırma kapsamına alınmıştır. Her ilçede 80 üretici ile olmak üzere toplam 320 üretici ile görüşülmesinde karar verilmiş ve görüşülecek üreticiler on köye, her ilçeye 80 üretici denk gelecek şekilde, dağıtılmıştır.

Anket çalışması üreticilerle bizzat araştırmacı tarafından yüz yüze görüşülerek yapılmıştır. Anket soruları daha önce bu konuda yapılmış çalışmalardan faydalanılarak hazırlanmıştır. Anket formunda, "işletmedeki nüfus ve işgücü", "İl ve İlçelerdeki işletmelerin çay yetiştiriciliği bilgileri", "hastalık ve zararlılar hakkında bilgi düzeyi", "yabancı ot türleri hakkında bilgi düzeyi", kimyasal mücadele konusunda bilgi düzeyi ve tutumu" olmak üzere beş başlık altında sorular hazırlanmıştır.

Anketlerden elde edilen veriler, Excel programında dökülerek frekans ve yüzde hesaplamalar ile değerlendirilerek tablo ve grafikler halinde sunularak yorumlanmıştır.

## BULGULAR VE TARTIŞMA

### 1.Üreticilerin Demografik Özelliklerine Yönelik Bulgular

Araştırma bulgularına göre çay üreticilerinin % 70'i erkek, %30'u kadınlardan oluşmaktadır. Türkiye geneli kırsal alan çalışmalarında kadın üretici oranının genellikle daha düşük olduğu görülmektedir. Bu oran kadın üreticilerin çay üretim alanlarında diğer bölgelere ve üretim dallarına göre, daha fazla söz sahibi olduklarını göstermektedir. Belen ve ark. (2020), Sivas ilinde buğday üretim alanlarında bitki koruma sorunlarının belirlenmesi üzerine yapmış olduğu çalışmasında, ankete katılan buğday üreticilerin neredeyse tamamının (%96,4) erkek olduğunu belirlemiştir.

Çay üreticilerinin yaş kriterlerine ait değerler Çizelge 1' de verilmiştir. Bulgulara göre, çay üreticilerinin yaşları 25 ile 72 arasında değişmektedir. Yaş ortalaması ise 49,78 olarak hesaplanmıştır.

**Çizelge 1.** Çay üreticilerinin yaş gruplarına göre dağılımı

Yaş aralıkları	Frekans	Yüzde(%)
25-29 yaş grubu	7	2
31-39 yaş grubu	44	14
40-50 yaş grubu	113	35
51-60 yaş grubu	103	32
61-72 yaş grubu	53	17
<b>Toplam</b>	<b>320</b>	<b>100</b>

Üreticilerin eğitim düzeylerine ilişkin bulgular Çizelge 2' de gösterilmektedir. Bulgulara göre çay üreticilerinin %31,3 ilköğretim, %25 ortaokul ve ilköğretim ve %23,8 oranında lise öğrenimi düzeyinde yoğunlaştığı görülmektedir. Okuryazar olanlarının oranının (%5,6) bugün için önemli düzeyde olduğu söylenebilir. Buna karşın araştırma alanında önlisans ve lisans mezunu düzeyinde olup çiftçilik yapanlar da olduğu görülmektedir. Özgümüş (2019)'ün Rize ilinde yapmış olduğu çalışma sonuçlarına göre, bölgedeki çay üreticilerinin %39'u ilköğretim, %20'si ortaokul, %20'si lise ve %21'i üniversite mezunudur. Yapılan bu iki araştırma örneğinden de görüldüğü gibi değerler birbirine oldukça yakındır. İki

çalışmanın sonuçları çay üretimi yapan üreticilerin eğitim düzeylerinin çok düşük olmadığını ortaya koymaktadır. Buna karşın halen ilköğretim mezunlarının en yüksek oranı aldığı, okuryazarlık düzeyinde eğitimi olanların bulunduğu görülmektedir. Araştırma alanındaki üreticilerin eğitim düzeylerinin Türkiye geneli çiftçi eğitim düzeyi profiline paralellik gösterdiği söylenebilir.

**Çizelge 2.** Üreticilerin eğitim düzeylerine göre dağılımı

Eğitim düzeyleri	Frekans	Yüzde(%)
Okur- yazar değil	4	1,3
Okur-yazar	18	5,6
İlkokul	100	31,3
Ortaokul	80	25
Lise	76	23,8
Yüksekokul	24	7,5
Fakülte	18	5,6
<b>Toplam</b>	<b>320</b>	<b>100</b>

Araştırma bulgularına göre üreticilerin %28'i yalnızca çiftçilik yapmaktadır. Bu oranın dışındaki çiftçilerin tarım üreticiliğinin yanı sıra başka uğraşları da bulunmaktadır. %28'i çiftçiliğin yanı sıra esnaflık, %18'i işçilik yoluyla para kazanmaktadır. Kadın üreticiler de tarımsal üretim yapmanın yanı sıra, ev hanımlığı da yaptıklarını belirtmişlerdir. %10'luk payla son olarak memur olanlar bulunmaktadır (Çizelge 3). Özgümüş (2019)'ün Bölgede yapmış olduğu çalışmada, işletmecilerin %41,11'inin emekli, %18,89'unun işçi ve esnaf, %11,11'inin özel sektör çalışanı, %10'unun ise memur olduğu tespit edilmiştir. Bu iki çalışma kıyaslandığında çay üreticilerinin meslek gruplarının oranları birbirlerine oldukça yakın olduğu görülmektedir. Bu sonuçlara göre Çay üretimi yapan üreticilerin çoğunun ikincil faaliyet olarak çay üretimi yaptığını söylemek mümkündür.

**Çizelge 3.** Üreticilerin meslek gruplarına göre dağılımı

Meslek	Frekans	Yüzde(%)
Yalnızca Çiftçilik	90	28
İşçi	57	18
Esnaf	88	28
Memur	33	10
Ev hanımı	52	16
<b>Toplam</b>	<b>320</b>	<b>100</b>

Ankete katılan üreticilerin tamamının pazara yönelik olarak yalnızca çay üreticiliği yaptıkları, bu ürünün dışında herhangi bir tarımsal ürün çeşidinin üretimini gerçekleştirmedikleri belirlenmiştir.

## 2. Üreticilerin çay üretimi sırasında karşılaştıkları bitki koruma sorunları

### 2.1.Üreticilerin karşılaştıkları çay hastalıkları, konuyla ilgili bilgi düzeyleri ve uygulamaları

Çalışmanın literatür taraması sürecinde elde edilen bilgilere göre, çay üretim alanlarında sorun teşkil eden hastalıklar bugüne kadar ekonomik açıdan büyük zarar meydana getirmemiş olsa da, belli başlı hastalık etmenleri çay üretimi için sorun teşkil etmektedir. Çay üreticileri hastalıkları tanımadıkları için semptom olarak ifade etmektedirler. Büyük olasılıkla bu duruma bağlı olarak görüşmeler sırasında cevap verirken hastalık etmenlerini tarif etmede sıkıntı yaşamışlar ve bir hastalık adı belirtmekten çok hastalık semptomlarıyla cevap vermişlerdir. Bu konuya ilişkin bulgular, Çizelge 4'de detaylı olarak verilmektedir. Üreticiler özellikle çay yapraklarının uç kısımlarında kuruma ve sararmadan şikâyetçi olmuşlardır. Yapraklarda görülen bu hastalıklar özellikle fungal etmenlerden kaynaklanmakta olup, *Colletotrichum coccodes* ve *Pestalotiopsis theae*'nin (gri ve kahverengi yanıklık hastalıkları) neden olduğu hastalıkları göstermektedir. Diğer taraftan *Glomerella cingulata*'nın neden olduğu antraknoz hastalığı da olabilir. Çay üreticisinin hastalıklar konusunda sınırlı deneyimleri olduğu, buna karşın ürün kalitesini önemli düzeyde düşürebilecek bir hastalık problemi ile karşı karşıya oldukları anlaşılmaktadır. Çay kalitesini doğrudan etkileyen en önemli kısmı olan, bir başka deyişle çayı çay yapan 2,5 yaprak kısmında oluşan herhangi bir kuruma veya sararma çayın kalitesini düşürerek üretimi



olumsuz yönde etkileyecektir. Görüşülen 320 kişiden %12'si, herhangi bir hastalık etmeninin üretim alanında sorun yaratmadığını belirtmişlerdir.

**Çizelge 4.** Üreticilerin çaylıklarda karşılaştıkları hastalıklar

Hastalık semptomları	Frekans	Yüzde (%)
Yapraklarda sararma	76	23,7
Çayda kuruma	84	26,2
Her ikisi	121	37,8
Hastalık yok	39	12,1
<b>TOPLAM</b>	<b>320</b>	<b>100</b>

Bulgulara göre üreticilerin bahsettikleri hastalıklara karşı %78'lik bir payla herhangi bir mücadele yapılmadığı sonucu ortaya çıkmıştır. Hastalıklara karşı mücadele yaptıklarını beyan eden %22'lik kısım kültürel mücadele olarak elle yolma ve budama yoluyla sararmış veya kurumuş yaprakları temizlediklerini ifade etmişlerdir. Hastalıklara karşı herhangi bir fiziksel ve kimyasal mücadele yöntemi kullanılmamakta olduğu, üretici görüşmelerinden anlaşılmaktadır. Birçok ürün için hastalık ve zararlı mücadelesinde sentetik kimyasalların öne çıktığı günümüzde, Türkiye çay alanları için ortaya konmuş olan bu sonucun oldukça önemli olduğu düşünülmektedir. Bu sonuç, hastalık etmenlerinin kimyasal mücadeleye çok fazla ihtiyaç duyulmadan kontrol altına alınabilme olanağını sağlayacak zamanlamayla yapılmış bir durum tespiti olarak değerlendirilebilir.

“Hastalıklara karşı mücadele uyguluyor musunuz?” sorusuna üreticilerin % 22,2'si mücadele ettiğini, % 77,8'i ise mücadele etmediğini bildirmiştir. Hastalıklara karşı mücadelede hedefin ne olması gerektiği sorusuna üreticilerin verdikleri cevaplar Çizelge 5'de verilmiştir. Bu bulgulara göre üreticiler arasında hastalıkla mücadelede hedefinin hastalığı baskı altına almak olduğunu belirten çok az üretici olmuştur. Özellikle kimyasal mücadele alışkanlığının yerleşmemiş olduğu bu bölgede çay üreticilerine hastalık ve zararlılarla mücadelede hedefin bu etmenleri ekonomik zarar eşliğinin altında tutmak olduğu bilincini kazandırmak, ekolojik dengeyi bozmadan ve çevreyi kirletmeden ekonomik çay üretimi yapmayı mümkün kılabilir. Bu bilincin üreticilere kazandırılması önemli görünmektedir. Çünkü mevcut durumda üreticiler hastalıklı bitkileri ayırma yöntemini kullanıp ilaçlı mücadeleye başvurmayarak, çok farkında olmadan çevreci bir hastalık mücadelesi yapmaktadırlar. Hastalıklarla mücadelede üreticilerin belirttikleri hedefler, çevreci mücadeleyi amaç edinmekten çok farkına varmadan yaptıklarını işaret etmektedir. Hastalıklarla mücadele ifade edilen hedefler, üreticilerin herhangi bir hastalık belirtisini çay üretim alanlarında hiç görmek istemediklerini ortaya koymaktadır. Aydın (2019) Kahramanmaraş ili Elbistan ilçesinde yaptığı bir çalışmada üreticilerden 78 kişi “Hastalık, zararlı ve ya yabancı otu tamamen ortadan kaldırmak” 42 kişi “Hastalık, zararlı ve ya yabancı otu kontrol altında tutmak” 6 kişi ise “Hastalık, zararlı ve ya yabancı otun görülmesi dahi bunların görülmemesi için önleyici uygulamalar yapmak” gerektiğini ifade etmişlerdir. Bu oranlara bakıldığında baskı altına alınması gerektiğini düşünenlerin sayısı oldukça azdır. Oysaki bitki koruma yöntemleri uygulanırken hedef kesinlikle ekonomik zarar seviyesi altında tutmak olmalıdır. Maalesef ki sonuçlar üreticilerin bu kanıda olmadığını göstermiştir.

**Çizelge 5.** Üreticilerin hastalıklara karşı mücadelede hedefleri

Hastalıklara karşı hedef	Frekans	Yüzde (%)
Ortaya çıkmadan önleyici tedbirler almak	174	54,3
Çaylıklara bulaşmışsa baskı altına almak	35	10,9
Hastalık popülasyonunu tamamen yok etmek	111	34,6
<b>TOPLAM</b>	<b>320</b>	<b>100</b>

### 3.2. Üreticilerin karşılaştıkları çay zararlıları, konuyla ilgili bilgi düzeyleri ve uygulamaları

Çay üreticileriyle yapılan bu çalışma öncesi gerek yapılan literatür çalışmaları gerekse Rize ili Tarım Gıda ve Hayvancılık Müdürlüğü, Çaykur ve Çay Araştırmaları Enstitüsüyle yapılan görüşmelerden

edinilen bilgilere göre, bugüne kadar çay üretim alanlarında ekonomik zarar seviyesini aşacak düzeyde sorun teşkil eden bir zararlı tür söz konusu değildir. Fakat son yıllarda özellikle Gürcistan sınırından ülkeye girdiği tespit edilen ve üreticiler arasında vampir kelebek olarak adlandırılan *Ricania simulans* (Walker 1851) zararlısı tehdit oluşturmaktadır. Çalışma bulgularına göre üreticilerin % 85,6'sının bu türden şikayetçi oldukları Çizelge 6'da görülmektedir. Bu zararlıyı problem olarak belirten üreticilerin oranı oldukça yüksektir ve son zamanlardaki çalışmaların neredeyse tamamının bu zararlı üzerine yapıldığı görülmektedir. *Ricania simulans*'ın Doğu Karadeniz Bölgesi'nde dağılımını ve yoğunluğunu belirlemek üzere 2009-2011 yıllarında yürütülen çalışmada bu zararlının bölgede önemli düzeyde popülasyon oluşturduğu belirlenmiştir (Ak ve ark., 2015). Rize Tarım, Gıda ve Hayvancılık Müdürlüğü, Çaykur ve Çay Araştırma Enstitüsü yoğun bir şekilde bu tür üzerine çalışmalar yaptıklarını, çeşitli toplantılarla üreticileri de bilgilendirerek zararlı türü baskı altına tutmaya çalıştıklarını belirtmişlerdir. Yapılan araştırma polifag bir zararlı olan bu türün mutlaka baskı altında tutulması gerektiğini göstermiştir (Ak ve ark., 2015). Çay ekonomik açıdan Türkiye için oldukça önemli bir yere sahiptir. Çayın ana üretim merkezi olan Doğu Karadeniz bölgesinde bu türe ait çalışmaların daha da artması gerekmektedir.

**Çizelge 6.** Çaylıklarda sorun oluşturan zararlı türler

Çaylıklarda sorun olan zararlılar	Frekans	Yüzde (%)
<i>Ricania simulans</i>	169	52,8
<i>Halyomorpha halys</i>	18	5,6
Her iki tür	105	32,8
Zararlı yok	28	8,8
<b>TOPLAM</b>	<b>320</b>	<b>100</b>

Üreticiler tarafından çay üretim alanlarında son dönemde sorun olduğu bildirilen diğer bir zararlı tür ise kahverengi kokarca böceği olarak da bilinen *Halyomorpha halys* (Stal, 1855) 'tir. *Ricania simulans* kadar olmasa da bu türün varlığından da üreticilerin rahatsız olduğu görülmüştür. Özgümüş (2019) yapmış olduğu çalışmasında, çalışma kapsamındaki çaylıklarda vampir kelebek olarak adlandırılan *R. simulans* zararlısının çay yapraklarında bitki öz suyunu emerek zarar meydana getirip verimin düşmesine sebep olduğunu bildirmiştir. Görüşülen üreticilerin %33'lük kısmı her iki türünde çay üretim alanlarında zarar meydana getirdiğini ve bu durumun onları endişelendirdiğini dile getirmişlerdir (Çizelge 6). Herhangi bir kimyasal mücadele bu aşamada kullanılmamaktadır. Biyolojik ve kültürel önlemlerle baskı altına alınmaktadır. Bu araştırmayla kıyaslama yapıldığında bu türün her iki çalışmada da üreticiler tarafından öncelikli sorun olarak ifade edildiği görülmektedir.

Çizelge 7'de yer alan oranlarda görüldüğü gibi, zararlılara karşı uygulanabilecek kültürel önlemleri bilmeyenlerin oranı %33'tür. Bir diğer deyişle her üç üreticiden biri kültürel önlemleri bilmemektedir. Üreticilerin farklı bitki koruma yöntemlerini öğrenmeleri konusunda eğitim faaliyetlerinin yürütülmesi önemli görülmektedir.

**Çizelge 7.** Üreticilerin zararlılara karşı kültürel önlemleri uygulama oranı

Kültürel önlemleri kullanma	Frekans	Yüzde(%)
Kullanmıyor	215	67,2
Kültürel önlemleri bilmiyor	105	32,8
<b>TOPLAM</b>	<b>320</b>	<b>100</b>

Bir diğer mücadele yöntemi olan fiziksel mücadeleyi uygulayan üretici bulunmamakta, üreticilerin %27,5'i bu grup mücadeleyi bilmemektedir (Çizelge 8). Üreticilerin %72,5'lük kısmı fiziksel mücadele uygulamalarını kullanmadıklarını belirtmişlerdir. Burada zararlılara karşı kullanılan fiziksel mücadele yöntemlerinden olan ışık ve renk tuzakları ile zararlılarla mücadele edilebileceği üreticilere ifade edilmiştir.

**Çizelge 8.** Üreticilerin zararlılara fiziksel mücadele yöntemlerini uygulama oranı

Fiziksel mücadele uygulama	Frekans	Yüzde(%)
Uygulamıyor	232	72,5
Fiziksel önlemleri bilmiyorum	88	27,5
<b>TOPLAM</b>	<b>320</b>	<b>100</b>

Üreticilerle yapılan görüşmelerde zararlılara karşı biyolojik ve biyoteknik mücadele yöntemlerini de uygulamadıkları görülmektedir (Çizelge 9, 10). Bugün için bu yöntemlerin üretici düzeyinde kullanılmasının oldukça zor olduğu söylenebilir. Görüldüğü üzere özellikle biyoteknik mücadele yöntemini görüşülen üreticilerin yarısından fazlası bilmediğini söylemiştir. Bu konuda üreticilere ulaşılarak alternatif mücadele yöntemleri anlatılmalı ve tavsiyelerde bulunulmalıdır. Herhangi bir ilaçlama yapılmadan çay üretimi bugüne kadar devam etmiştir. Bugünden sonrası için de bu durumun muhafaza edilmesi önemlidir.

**Çizelge 9.** Üreticilerin zararlılara biyolojik önlem uygulama oranı

Biyolojik mücadele uygulama	Frekans	Yüzde(%)
Uygulamıyor		55
Biyolojik önlemleri bilmiyorum		45
<b>TOPLAM</b>	<b>320</b>	<b>100</b>

**Çizelge 10.** Üreticilerin zararlılara biyoteknik önlem uygulama oranı

Biyoteknik mücadele uygulama	Frekans	Yüzde(%)
Uygulamıyor		38
Biyoteknik mücadele yöntemini bilmiyor		62
<b>TOPLAM</b>	<b>320</b>	<b>100</b>

*Ricania simulans*'a karşı çay alanlarında henüz kimyasal mücadele yapılmadığı alternatif mücadele yöntemlerinden biyolojik ve biyoteknik mücadele yöntemlerine yönelik çalışmaların yapılmasının gerekli olduğu düşünülmektedir. Göktürk ve Mihli (2015), *R. simulans*'ın mücadelesine yönelik yapmış oldukları çalışmada asılan ışık ve yapışkan bant tuzaklarıyla belli oranlarda ergin yakalandığını bildirmişlerdir. Işık tuzakları kullanılarak yapılacak mücadele daha etkili olması açısından bireysel mücadele çalışmalarından ziyade geniş alanlarda yapılmasını tavsiye etmektedirler. Predatör bir tür olan *Formica rufa* L.(Kırmızı Orman Karıncası) 'nın bölgede yaygınlaştırılması bu etmenlerle mücadelede önemli bir rol oynayacaktır. Bu karınca türü et oburdur ve *Ricania japonica* 'da dahil tüm böcek türlerinin yumurta, larva ve pupalarıyla beslediği için popülasyonlarını baskı altında tutabilmektedir. Türkiye'de *F. rufa* OGM (Orman Genel Müdürlüğü) tarafından, ormanlarda ve orman fidanlıklarında zararlı tehdidi görülen tüm alanlarda yaygın olarak kullanılmaktadır. Çalışmadan elde edilen bulgular çay üretimi yapılan alanlarda henüz hiçbir zararlı türe karşı kimyasal mücadele yapılmadığını göstermiştir. Hali hazırda çaya ruhsatlı kimyasal bir bitki koruma ürünü bulunmamaktadır. Bu durumda üreticiler zararlılarla mücadele konusunda kültürel, fiziksel, biyoteknik ve biyolojik mücadele uygulamalarını tercih etmek zorundadır. Bulgular üreticilerin kimyasal mücadele konusundaki yasal engele riayet ettiklerini ortaya koymaktadır. Türkiye'de çay üretim alanlarının kar yağışına maruz kalması tarımsal mücadele için avantaj oluşturmada, bu durumun da kimyasal mücadeleye başvurmadan konusunda üreticiyi desteklediği anlaşılmaktadır. Bu şekilde Türkiye'de üretilen çayların kimyasal kalıntısı açısından oldukça güvenilir ve sağlıklı yetiştirildiği ortaya çıkmaktadır. Zararlı türlerin kimyasal kullanımı dışında çeşitli yöntemlerle baskı altında tutulması sağlanırsa, bugüne kadar olduğu gibi kimyasal mücadeleye başvurmadan zararlı yönetimi mümkün olabilir. Bu durum, Türkiye'de üretilen çay için önemli bir avantaj olarak değerlendirilebilir.

Bulgulara göre tespit edilen zararlı türlere karşı üretim alanlarında üreticilerin herhangi bir kimyasal mücadele yapmadığı anlaşılmaktadır. Devlet kimyasal mücadeleye çay üretim alanlarında müsaade etmemektedir. Bunun yanında zararlılarla mücadelede kültürel önlemleri bilmeyen üreticilerin sayısı



oldukça yüksektir. Araştırma bulguları, yapılan literatür çalışması ve araştırma süresince görüşülen kurumlardan alınan bilgilere göre Türkiye’de üretilen çaylarda kimyasal ilaçlama yapılmamaktadır.

**Çizelge 11.** Üreticilerin zararlılara karşı mücadelede hedefleri

Zararlılarla mücadelede hedef	Frekans	Yüzde(%)
Zararlı ortaya çıkmadan önleyici tedbirler almak	187	58,4
Zararlıları tamamen ortadan kaldırmak	28	8,8
Zararlı çay üretim alanına bulaşmışsa zararlıyı baskı altına almak	105	32,8
<b>TOPLAM</b>	<b>320</b>	<b>100</b>

Araştırma bulgularına göre üreticilerin zararlılara karşı mücadelede hedef olarak zararlı ortaya çıkmadan önleyici tedbirler almak gerektiğini düşünenlerin oranı %58,4 olarak hesaplanmıştır. Zararlı çay üretim alanına bulaşmışsa baskı altına almak gerektiğini düşünen üretici oranı ise %32,8 olarak belirlenmiştir (Çizelge 11).

### 3. Üreticilerin karşılaştıkları yabancı otlar, konuyla bilgi düzeyi ve uygulamaları

Araştırma bulguları çay yetiştiriciliği yapılan alanlarda bitki koruma sorunları içerisinde en fazla problem oluşturan grubun yabancı otlar olduğunu göstermiştir. Çizelge 12’de yer alan bulgulara göre bazı üreticilerin birden fazla yabancı ota karşılaştığı anlaşılmaktadır. Özellikle sarmaşık ve kokar ot yüksek oranlarıyla dikkat çekmektedir. Yabancı otların rekabet etme gücü kültür bitkilerine göre daha fazla olduğundan üreticiler çaylıklarda yabancı ot gördükleri zaman daha tedirgin olduklarını ifade etmişlerdir. Araştırma öncesi literatür taramalarında ve kurum görüşmelerinde, özellikle yabancı otlarla alakalı çalışmaların oldukça kısıtlı olduğu belirlenmiştir.

**Çizelge 12.** Üreticilerin şikayetçi oldukları yabancı ot türleri

Zarar yapan yabancı ot türleri	Frekans	Yüzde(%)
Yabani hardal	5	1,3
Kokar ot	106	30,9
Ballı baba	34	9,7
Pıtrak	23	6,3
Sarmaşık	291	88,8

\*Bazı üreticiler birden fazla seçenekle cevap verdikleri için toplamlar yüzü aşmaktadır.

Görüşme yapılan üreticilerin tamamı yabancı otlara karşı mücadele ettiklerini bildirmişlerdir. Bu mücadele yöntemleri el ile yolma %76, biçme ise %24’tür (Çizelge 12). Burada da görüldüğü gibi çay üreticilerinin büyük bir kısmı el ile yolma metoduyla yabancı otlarla mücadele etmektedir. Her yıl düzenli olarak yapmış oldukları çaylık bakımı ve budama da elbette yabancı ot seviyesini düşürmektedir. El ile yolma mücadele yöntemleri içerisinde zaman alan bir yöntem olsa da şimdilik çay alanlarında kimyasal ilaçlamaya gerek olmadığı, yabancı otların ekonomik zarar seviyesinin altında olduğu Çizelge 13’de yer alan verilerden anlaşılmaktadır.

**Çizelge 13.** Üreticilerin yabancı otlara karşı uyguladığı mücadele yöntemleri

Uygulanan yöntem	Frekans	Yüzde(%)
El ile yolma	244	76,3
Biçme	76	23,8
<b>TOPLAM</b>	<b>320</b>	<b>100</b>

Üreticilerin yabancı otlara karşı mücadelede hedef ne olmalı konusunda %70’i çaylıklarda yabancı otu gördükleri anda yok etmek gerektiğini düşünmektedirler. Bu da gösteriyor ki yabancı otların mücadelede diğer bitki koruma sorunları olan zararlılar ve hastalık etmenlerine göre daha inatçı ve ekonomik anlamda daha zarar vereceğini düşünmektedirler.

**Çizelge 14.** Üreticilerin yabancı otlara karşı mücadelede hedefi

Yabancı otlarla mücadelede hedef	Frekans	Yüzde(%)
Yabancı ot çay üretim alanlarında görüldüğü anda yok etmek	223	69,7
Yabancı ot yoğunluğunu belirli bir düzeyin altında tutmak	97	30,3
<b>TOPLAM</b>	<b>320</b>	<b>100</b>

Araştırma bulgularına göre üreticilerin hastalık, zararlı ve yabancı ot türlerinin hangi yollarla yayıldığı konusundaki bilgileri Çizelge 15’de verilmektedir. Üreticilerin yarısından fazlası tarımsal aletler, temiz olmayan fide, fidan, tohumlar yoluyla ve bitki artıklarıyla fazlaca bulaşma meydana geldiğini belirtmişlerdir. Çayda sulamaya gerek olmadığı için buradan bulaşmanın olmayacağını düşünenler sayıca fazladır. Rüzgar yoluyla da çaylıklara bulaşabileceğini beyan eden üretici oranı %21’lerdedir.

**Çizelge 15.** Üreticilerin hastalık, zararlı ve yabancı otların yayılma yolları hakkındaki düşünceleri

Bitki koruma sorunlarının yayılma yolları	Frekans	Yüzde(%)
Tarımsal aletler yoluyla	212	66,1
Temiz olmayan fide fidan ve tohumlarla	179	59,1
Sulama ve drenaj sularıyla	6	1,8
Bitki artıkları ve çiftlik gübresiyle	98	30,6
Rüzgar yoluyla	67	20,9

\*Bazı üreticiler birden fazla seçenekle cevap verdikleri için toplamlar yüzü aşmaktadır.

Üreticiler kimyasal ilaç kullanmadıkları için ilaçlama ile ilgili soruları cevaplamak istememişlerdir. Çaylıklarda üretilen çayları herhangi bir kimyasal ilaç kullanılmadan evlere girmektedir. Bu verilerden yola çıkılarak, çayın merkezi olan Doğu Karadeniz bölgesinden sofralara gelen çayların tamamen doğal, sağlıklı ve güvenilir olduğu sonucuna varılmaktadır.

#### 4. Üreticilerin çay üretiminin de tarımsal mücadele konusunda bilgi kaynakları ve bilgi edinme eğilimleri

Araştırma bulguları çay üreticisinin bitki koruma sorunları karşısında herhangi bir bilgiye ihtiyacı olup olmadığı Çizelge 16’da yer almaktadır. Ankete katılan üreticilerin yarısından fazlası bitki koruma sorunlarından olan zararlı, hastalık ve yabancı otlarla mücadele yönetimi konusunda bazen bilgiye ihtiyacı olduğunu belirtmiştir. Bu konuda çok fazla bilgiye ihtiyacı olduğunu düşünenlerin oranı %27’dir. Bu sonuçlar göstermektedir ki üreticilerin bitki koruma sorunlarına karşı bazen de olsa bilgi ihtiyaçları bulunmaktadır. İleride yapılan çalışmaların üreticilere bu konuda yardımcı olmak adına artırılması gerektiği görülmektedir.

**Çizelge 16.** Üreticinin bitki koruma sorunlarına karşı bilgiye ihtiyaç duyma düzeyi

Bilgi ihtiyacı düzeyi	Frekans	Yüzde(%)
Hiç duymuyor	12	3,8
Çok nadir	25	7,8
Bazen	173	54,1
Çok fazla	85	26,6
Sürekli/her zaman	25	7,8
<b>TOPLAM</b>	<b>320</b>	<b>100</b>

Hastalık, zararlı ve yabancı otlarla mücadele konusunda bilgiye ihtiyacı olduğunu düşünen üreticilerin çoğunlukta olması, üreticilerin gelişme kendilerini geliştirme eğilimine işaret ettiği için,

sevindirici bir durum olarak değerlendirilebilir. Bu çoğunluğun yararlanmış olduğu bilgi kaynakları ise Çizelge 17’de detaylı olarak verilmiştir. Üreticilerin bilgi kaynağı olarak görüp başvurduğu kaynaklar arasında sırasıyla, Çaykur eksperleri, Tarım İl Müdürlüğü elamanları, internet, Ziraat odası çalışanları, önder çiftçiler olarak görülmektedir. Bu bulgulara göre üreticilerin bilgi kaynağı olarak en fazla güvendiği ve başvurduğu kişiler Çaykur eksperleri ve Çaykur ziraat mühendisleridir (Çizelge 17). Bölgede Çaykur’un üretici açısından önemi bu bulgular sonucunda ortaya çıkmaktadır.

**Çizelge 17.** Üreticinin hastalık, zararlı ve yabancı otlarla mücadelede bilgi kaynakları

Bilgi kaynakları	Frekans	Yüzde(%)
Sadece kendi deneyimi	16	5
Tarım il/ilçe müdürlüğü	119	36
Serbest tarım danışmanları	62	19,2
Ziraat odası tarım danışmanları	103	32,1
TV	67	20,9
Radyo	41	12,7
İnternet	74	23,1
Önder çiftçi- diğer çiftçiler	100	32,4
Çaykur eksperleri	148	46,1
Çaykur ziraat mühendisleri	131	45,9

\*Bazı üreticiler birden fazla seçenekle cevap verdikleri için toplanlar yüzü aşmaktadır.

Üreticilerin çay üretiminde “Tarımsal mücadele konulu herhangi bir eğitim toplantısına katılıp katılmadığı” sorulduğunda görüşülen üreticilerin %86’sı herhangi bir toplantıya katılmadığını %14’ü ise bu tarz toplantılara katıldığını bildirmişlerdir. Bu oranlar üreticilerin kendileri açısından önemli olan çay üretiminde karşılarına çıkabilecek tarımsal sorunlar için, bu tür çabalara çok girmediği izlenimi oluşturmaktadır. Toplantılara katılanlar oldukça düşük bir orandadır. Çay gibi ekonomik anlamda önemli bir ürün için kendilerini geliştirme fırsatlarını çok fazla değerlendirmedikleri görülmektedir. Yanar ve ark. (2018), örtü altı yetiştiricilikte üreticilerin mücadele uygulamaları konusunda bilinç düzeyinin artırılması gerektiğini vurgulamışlardır. Belen ve ark., (2020) yapmış olduğu buğdayda bitki koruma sorunlarının belirlenmesi konulu çalışmasında üreticilerin %69.50’sinin buğdayda sorun olan hastalık ve zararlılarla ilgili toplantılara katıldığını bildirmiştir. Bu iki çalışma arasında bir karşılaştırma yapılacak olursa, buğday üreticilerinin bitki koruma sorunlarının belirlenmesi konusunda yapılacak toplantılara daha ilgili oldukları görülmüştür.

Tarımsal mücadele konulu eğitim toplantılarına katıldığını beyan eden üreticilerin katıldığı toplantıları düzenleyen kurumların hangileri olduğuna ilişkin sonuçlar Çizelge 18’de yer almaktadır. Bulgular, tarımsal mücadele konulu toplantıları düzenleyen kurumlar arasında Çaykur’un önde yer aldığını göstermektedir. Burada üretici yine diğer kurumlardan fazla Çaykur’un eğitim toplantılarına katılmış, bu kurumla daha fazla muhatap olmuştur.

**Çizelge 18.** Çayda mücadele konusunda katılım sağlanan kursları düzenleyen kurumlar

Kurum	Frekans	Yüzde(%)
Çaykur	30	66,7
Tarım İl Müdürlüğü	4	8,9
Ziraat odası	11	24,4
<b>TOPLAM</b>	<b>45</b>	<b>100</b>

Araştırmada üreticilere bu tarz toplantıların bundan sonrasında da düzenlenmesi durumunda katılım gösterip göstermeyeceği sorusunun cevapları Çizelge 19’da yer almaktadır. Bu bulgulara bakıldığında üreticilerin %62’si bu tür toplantıların gerekli olduğunu düşündüğünü ve olduğunda katılabileceğini beyan etmiştir.



**Çizelge 19.** Üreticilerin tarımsal mücadele konulu toplantılara katılım düzeyi

Gelecek tarımsal mücadele konulu toplantılarla ilgili tutum	Frekans	Yüzde(%)
Bu tür toplantıların gerekli olduğunu düşünüyor, olsa katılabilir	198	61,9
Bu tür toplantıların çok gerekli olduğunu düşünüyor, olsa mutlaka katılır	66	20,6
Bu tür bir toplantının gerekli olduğunu düşünmüyor, olsa katılmaz	32	10
Bu tür bir toplantının gerekli olduğunu düşünmüyorum ama katılabilirim	15	4,7
Bu tür toplantıların gerekli olduğunu düşünüyor, ama olsa katılmam	9	2,8
<b>TOPLAM</b>	<b>320</b>	<b>100</b>

## SONUÇ

Bu çalışmada, Rize ilinde çay üretim alanlarında görülen hastalıklar, zararlılar ve yabancı otlar konusunda üreticilerin bilinç düzeyleri yüz yüze yürütülen anket çalışmaları ışığında ortaya konulmuştur. Elde edilen bulgular bölge üreticilerine yönelik, hastalıklar, zararlılar ve yabancı otlarla mücadele yöntemleri konusunda bilgilendirme ve eğitim programlarının düzenlenmesi gerektiğini ortaya koymaktadır. Üreticilere özel yapılabilecek toplantılar, eğitimlerle mücadele yöntemleri detaylı olarak anlatılmalı, üreticinin bilinçlendirilmesi sağlanmalıdır. Kimyasal mücadele konusu üreticilere soru olarak yönlendirildiğinde hepsi kimyasal mücadele çay üretim alanlarında yasak olduğundan dolayı kullanmadıklarını ifade etmişlerdir. Dünyada üretilen çaylar arasında üzerine kar yağın tek çay Türkiye'nin Karadeniz bölgesinde yeşeren Türk çayı olması avantajı ile bugüne kadar herhangi bir kimyasal mücadeleye gerek kalmadan doğal ve güvenilir çay üretimi yapılmakta olduğu, araştırmalar sonucunda ortaya konmuştur. Kimyasal mücadeleye başvurulmaması çok önemli bir avantaj olmakla birlikte, üreticilere hastalık - zararlılar ve diğer mücadele yöntemleri konusunda daha bilinçli bir noktaya taşınması gerektiği de açıktır. Hastalık-zararlı etmenlerinin tanınması, ortaya çıkabilecek potansiyel zararlılar konusunda farkındalık oluşturulması, bunların kontrolünde bilgi ve becerinin artırılması önemlidir. Kimyasal mücadele dışında zararlıları kontrol altına alabilecek mücadele yöntemleri farkındalık ve beceri gerektirmektedir. Bunların üreticilere kazandırılması amacıyla Bakanlık, Bakanlık'ın il teşkilatları, üniversitelerin ilgili bölümleri işbirliği ile yapılacak çalışmalar büyük önem taşımaktadır.

## KAYNAKÇA

- Ak, K., Güçlü, Ş., Eken C., Sekban, R.,2015. Türkiye için yeni bir zararlı *Ricania simulans* (Walker, 1851),Türkiye entomoloji. dergisi39 (2): 179-186.
- Ak, K., Mansur,U.,Tunçer, C., 2023. Distribution and population density of *Halyomorpha halys* (Stål, 1855) (Hemiptera: Pentatomidae) in Black Sea Region of T omidae) in Black Sea Region of Türkiye,Turkish Journal of Zoology,47(120-129).
- Aydın, Ö., 2019. Kahramanmaraş İli Elbistan İlçesinde Nohut Üretimi Yapan Çiftçilerin Bitki Koruma Sorunlarının ve Zirai Mücadele Konusundaki Bilgi Düzeylerinin Belirlenmesi.(Y.Lisans Tezi), Kırşehir Ahi Evran Üniversitesi,Tarımsal Biyoteknoloji, Kırşehir.
- Belen, M., Yanar, D., Erdal, G., 2020. Sivas İlinde Buğday Üretiminde Karşılaşılan Bitki Koruma Sorunlarının Belirlenmesi. Turkish Journal of Agriculture - Food Science and Technology, 8(sp1): 208-214.
- Bozan, İ., Zoral, A., ve Aslıtürk, H.,1972. Doğu Karadeniz Bölgesinde Çay Koşnili ( *Pulvinaria floccifera* Westw. ) ' ne Karşı İlâç Denemeleri, Cilt no:12.
- Çakır, O., Ceylan S., 1987. Doğu Karadeniz Bölgesi çay (*Camellia sinensis* L.) üretim alanlarında hastalık oluşturan etmenlerin tespiti üzerinde ön çalışmalar. Bitki Koruma Bülteni, 27 (1-2): 87-99.
- Çuhadar, B., 2015. Yaş ve Kuru çayda, verim ve önemli kalite parametrelerine sarı çay akarı (*Polyphagotarsonemus latus* (Banks, 1904)) (Prostigmata: Tarsonemidae)'nın etkisi, Ordu Üniversitesi, Fen Bilimleri Enstitüsü,Ordu.
- Demir, A., 2002. Çay, T.E.A.E.-Bakış, Tarımsal Ekonomi Araştırma Enstitüsü, (1/10) 1-4, <http://www.gdf.org.tr/tr/rapor/TEAE/2002/cay2002.pdf>.

- Dündar, A., (2016) Karadeniz İncelemeleri Dergisi, (21): 269-280.
- Göktürk T., ve Mihli, A., 2015. Doğu Karadeniz sahil şeridinin önemli zararlısı *Ricania simulans* (Walker,1851) (Hemiptera: Ricaniidae)'ın mücadelesi üzerine araştırmalar, Artvin Çoruh Üniversitesi Orman Fakültesi Dergisi, Yıl: 2015, Cilt: 16, Sayı:1, Sayfa: 89-93.
- Özdemir, İ., Tuncer, C., 2021. Türkiye'de yeni bir istilacı polifag, kahverengi kokarca [*Halyomorpha halys* (Stål, 1855) (Hemiptera: Pentatomidae)]: tanımı, benzer türler ve mevcut durum, Black Sea Journal of Engineering and Science, Cilt 4, s58-67.
- Özgümüş, İ., 2019. Rize ilinde Çay İşletmelerinin Sosyo-ekonomik Yapısı ve Pazarlama Sorunları Yüksek lisans tezi, Isparta Uygulamalı Bilimler Üniversitesi, 56s.
- Yanar, D., Yanar, Y., Erdal, H., Erdal, G., 2018. Antalya ilinde örtü altı yetiştiriciliğinde karşılaşılan bitki koruma sorunları ve üretici bilinç düzeyi, S:38-48, Tokat.



## Basit Regresyon Modelinin Farklı Paket Programlar Uygulamaları

**İbrahim CATIR**<sup>1\*</sup>

<sup>1</sup>Trakya Üniversitesi, Veri Bilimi ve Analitiği Bölümü, 22020, Edirne, Türkiye

\*Sorumlu yazar e-mail: ibrahimcatir@gmail.com

### Özet

*Bu çalışmada, uygulamalı istatistik alanında son zamanlarda geliştirilen yeni yöntemler ve yaklaşımlar incelenmiştir. Daha önce kullanılan istatistiksel yöntemlerin yanı sıra araştırmacıların ve akademisyenlerin Python ve R gibi yazılım dillerinin de analizlerinde uyguladıkları ilham alınarak ortaya çıkan yeni teknikler ele alınmıştır. Özellikle, bu çalışmada aşağıdaki programlar ile basit regresyon modeli uygulamaları ve adımları gösterilecektir.*

*Basit regresyon modelini Excell, Eviews, Stata, R, SPSS, Python ile uygulama ve adımlarını gerçekleştirilecektir. Amacımız regresyon modelini kullanacak yeni araştırmacılara kılavuz olması amaçlanmaktadır.*

**Anahtar Kelimeler:** Basit Regresyon Analizi, Eviews, Stata, Spss, Python

### Abstract

*In this study, new methods and approaches recently developed in the field of applied statistics are examined. Alongside the previously used statistical methods, new techniques inspired by the software languages such as Python and R, which are also applied in the analyses of researchers and academics, are discussed. Specifically, this study will demonstrate simple regression model applications and steps using the following programs. The simple regression model will be applied and the steps will be carried out using Excel, Eviews, Stata, R, SPSS, and Python. Our goal is to provide a guide for new researchers who will use the regression model.*

**Keywords:** Simple Regression Analysis, Eviews, Stata, SPSS, Python

### Veri Seti

Kullanılan veri seti Selahattin Gürüş ve Ebru Çağlayan AKAY tarafından yazılan ‘‘EKONOMETRİ TEMEL KAVRAMLARI’’ Adlı kitabın 3.1. örneğini kullanılmıştır. Bir bağımlı ve bir bağımsız değişkenden oluşan veri seti 12 aileden oluşmaktadır. Bağımlı değişken (y): Gıda Harcamaları, Bağımsız değişken (x): Aylık gelir oluşturmaktadır (GÜRÜŞ & AKAY, 2018, s. 99).

Aile	Gıda Harcamaları	Aylık Gelir(x)
1	2,2	2,8
2	3	3,5
3	4,1	12,5
4	4,7	6,4
5	4,2	5,9
6	6,3	8
7	4,6	9,7
8	8,8	20,6
9	7,3	15,9
10	4,4	6,7
11	6,9	11,3
12	3,5	4,7



## Excel Uygulaması

Microsoft Excel, tüm temel tablo oluşturma işlemlerini barındırır. Numaralandırılmış satırlar ve harflerle adlandırılmış sütunlardan oluşan bir ızgara kullanarak aritmetik işlemler gibi veri manipülasyonlarını düzenler. İstatistik, mühendislik ve finansal ihtiyaçları karşılayan çeşitli fonksiyonlar içerir. Ayrıca, çizgi grafikleri, histogramlar ve tabloların yanı sıra sınırlı sayıda 3 boyutlu grafikler de gösterebilir. Microsoft, 1982 yılında ilk olarak 'Multiplan' adlı bir elektronik tablo programını piyasaya sürmüştü. Bu program, CP/M sistemi kullanıcıları için oldukça uygunken, MS-DOS sistemi için Lotus 1-2-3 daha popülerdi. ([https://tr.wikipedia.org/wiki/Microsoft\\_Excel](https://tr.wikipedia.org/wiki/Microsoft_Excel), 2024).

Excel uygulamasını öncelikle el ile hesaplayıp uygulamalar ile aynı sonuçları elde edeceğimizi ispatlamak adına çözeceğiz.

### Normal Denklemler ile çözümü

Y	X	YX	X <sup>2</sup>
2,2	2,8	6,16	7,84
3	3,5	10,5	12,25
4,1	12,5	51,25	156,25
4,7	6,4	30,08	40,96
4,2	5,9	24,78	34,81
6,3	8	50,4	64
4,6	9,7	44,62	94,09
8,8	20,6	181,28	424,36
7,3	15,9	116,07	252,81
4,4	6,7	29,48	44,89
6,9	11,3	77,97	127,69
3,5	4,7	16,45	22,09
<b>60</b>	<b>108</b>	<b>639,04</b>	<b>1282,04</b>

n= 12

### Normal denklemler Formülü;

$$\sum Y_i = n \cdot \beta_0 + \beta_1 \cdot \sum X_i$$

$$\sum X_i \cdot Y_i = \sum X_i \cdot \beta_0 + \beta_1 \cdot \sum X_i^2$$

$$60 = 12 \cdot \beta_0 + 108 \cdot \beta_1$$

$$639,04 = 108 \cdot \beta_0 + 1282,04 \cdot \beta_1$$

$$\beta_0 = 2,1254$$

$$\beta_1 = 0,3194$$

### Gerçek değerler Formülü;

$$\beta_1 = \frac{\sum X_i \cdot Y_i - n \cdot \bar{X} \cdot \bar{Y}}{\sum X_i^2 - n \cdot \bar{X}^2}$$

$$\beta_0 = \bar{Y} - \bar{X} \cdot \beta_1$$

$$\bar{X} = 108/12 = 9$$

$$\bar{Y} = 60/12 = 5$$

$$\beta_1 = \frac{639,04 - 12 \cdot (9) \cdot (5)}{1282,04 - 12 \cdot 81} = \frac{99,04}{310,04} = 0,3194$$

$$\beta_0 = 5 - 9 \cdot 0,3194$$

$$\beta_0 = 2,1254$$

**Ortalamadan Farklar Formülü;**

$$\beta_1 = \frac{\sum(X_i - \bar{X})(Y_i - \bar{Y})}{\sum(X_i - \bar{X})^2}$$

$$\beta_0 = \bar{Y} - \bar{X} * \beta_1$$

Y	X	y- $\bar{y}$	x- $\bar{x}$		
2,2	2,8	-2,8	-6,2	17,36	38,44
3	3,5	-2	-5,5	11	30,25
4,1	12,5	-0,9	3,5	-3,15	12,25
4,7	6,4	-0,3	-2,6	0,78	6,76
4,2	5,9	-0,8	-3,1	2,48	9,61
6,3	8	1,3	-1	-1,3	1
4,6	9,7	-0,4	0,7	-0,28	0,49
8,8	20,6	3,8	11,6	44,08	134,56
7,3	15,9	2,3	6,9	15,87	47,61
4,4	6,7	-0,6	-2,3	1,38	5,29
6,9	11,3	1,9	2,3	4,37	5,29
3,5	4,7	-1,5	-4,3	6,45	18,49
60	108			99,04	310,04

5  
12

$$\beta_1 = \frac{99,04}{310,04} = 0,3194$$

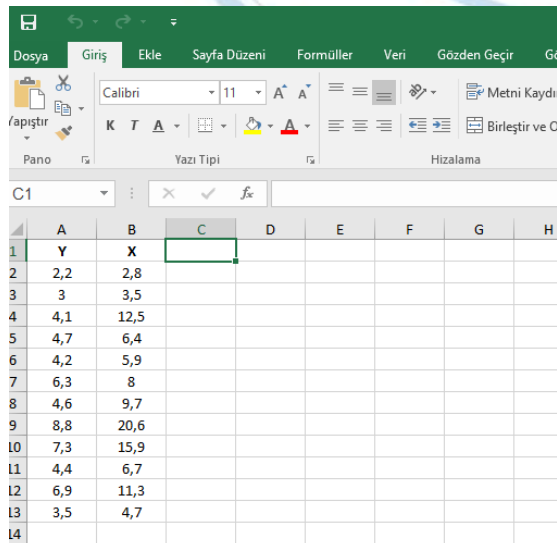
$$\beta_0 = 5 - 9 * 0,3194 = 2,1254$$

Basit regresyon modelini Normal dağılım, Gerçek değerler ve ortalama farklar yöntemi kullanarak çözdük ve model;

$$Y_i = 2,1254 + 0,3194 * X$$

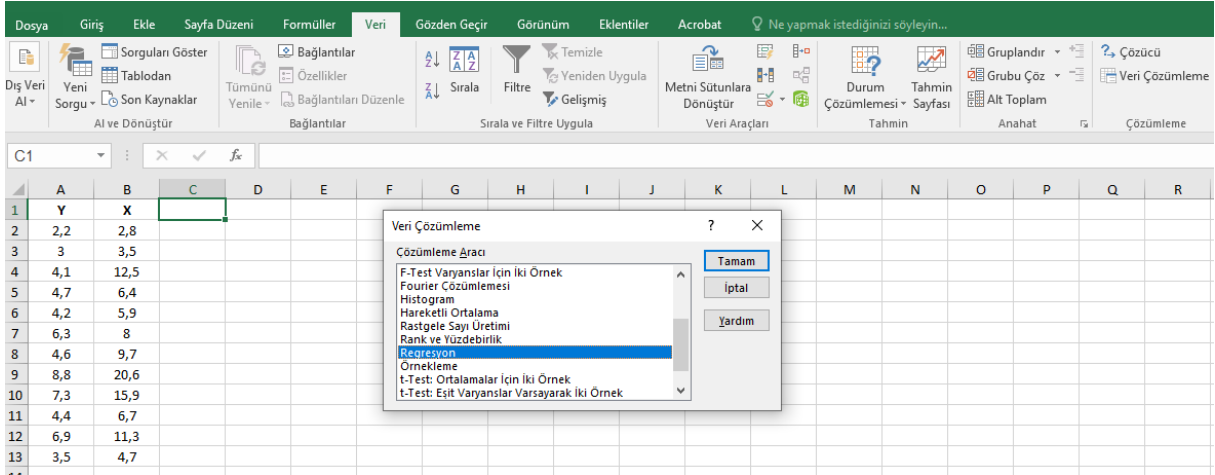
Excel de öncelikle veri çözümlene aktif hale getirilmelidir. Excel de eklentilerden veri çözümlene eklenmelidir ve şu adımlar izlenmelidir;

**1. Adımda:** Bağımlı ve bağımsız değişkenler excele girilir.



The screenshot shows the Microsoft Excel interface. The 'Giriş' (Home) tab is active. The ribbon includes options for font, paragraph, and styles. The formula bar is empty. The worksheet grid shows columns A through H and rows 1 through 14. Column A is labeled 'Y' and column B is labeled 'X'. The data points from the table above are entered into these columns: (2,2), (3), (4,1), (4,7), (4,2), (6,3), (4,6), (8,8), (7,3), (4,4), (6,9), (3,5).

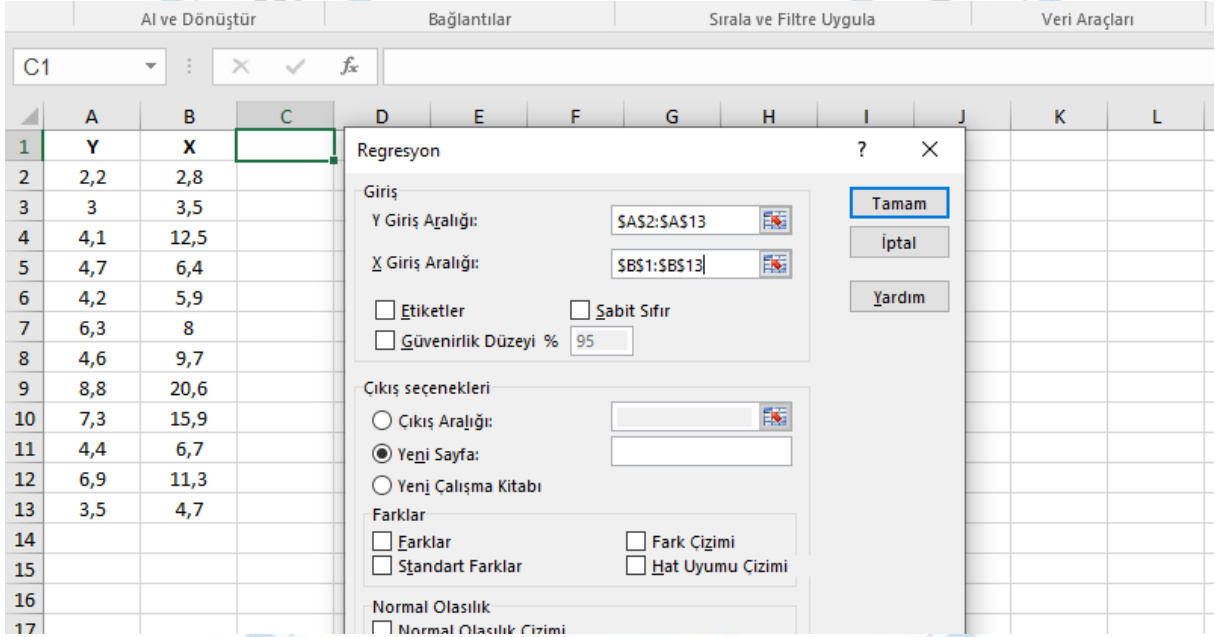
2. Adımda: Veri -> Veri çözümlene -> regresyon seçilir.



The screenshot shows the Excel 'Veri Çözümleme' (Data Analysis) dialog box. The 'Regresyon' (Regression) option is selected in the list. The background shows a data table with columns Y and X.

	Y	X
2	2,2	2,8
3	3	3,5
4	4,1	12,5
5	4,7	6,4
6	4,2	5,9
7	6,3	8
8	4,6	9,7
9	8,8	20,6
10	7,3	15,9
11	4,4	6,7
12	6,9	11,3
13	3,5	4,7

3. Adımda: Giriş başlığı altında y giriş aralığı ve x giriş aralığı sütünde taranarak seçilir. Tamam tıklanır ve aşağıdaki özet çıkışı penceresi açılır.



The screenshot shows the Excel 'Regresyon' (Regression) dialog box. The 'Y Giriş Aralığı' is set to '\$A\$2:\$A\$13' and the 'X Giriş Aralığı' is set to '\$B\$1:\$B\$13'. The 'Güvenirlilik Düzeyi' is set to 95%.

	Y	X
2	2,2	2,8
3	3	3,5
4	4,1	12,5
5	4,7	6,4
6	4,2	5,9
7	6,3	8
8	4,6	9,7
9	8,8	20,6
10	7,3	15,9
11	4,4	6,7
12	6,9	11,3
13	3,5	4,7

ÖZET ÇIKIŞI

Regresyon İstatistikleri	
Çoklu R	0,876513
R Kare	0,768276
Ayarlı R Kare	0,745103
Standart Hata	0,976852
Gözlem	12



ANOVA

	df	SS	MS	F	Anlamlılık F
Regresyon	1	31,6376	31,6376	33,15476	0,00018315
Fark	10	9,5424	0,95424		
Toplam	11	41,18			

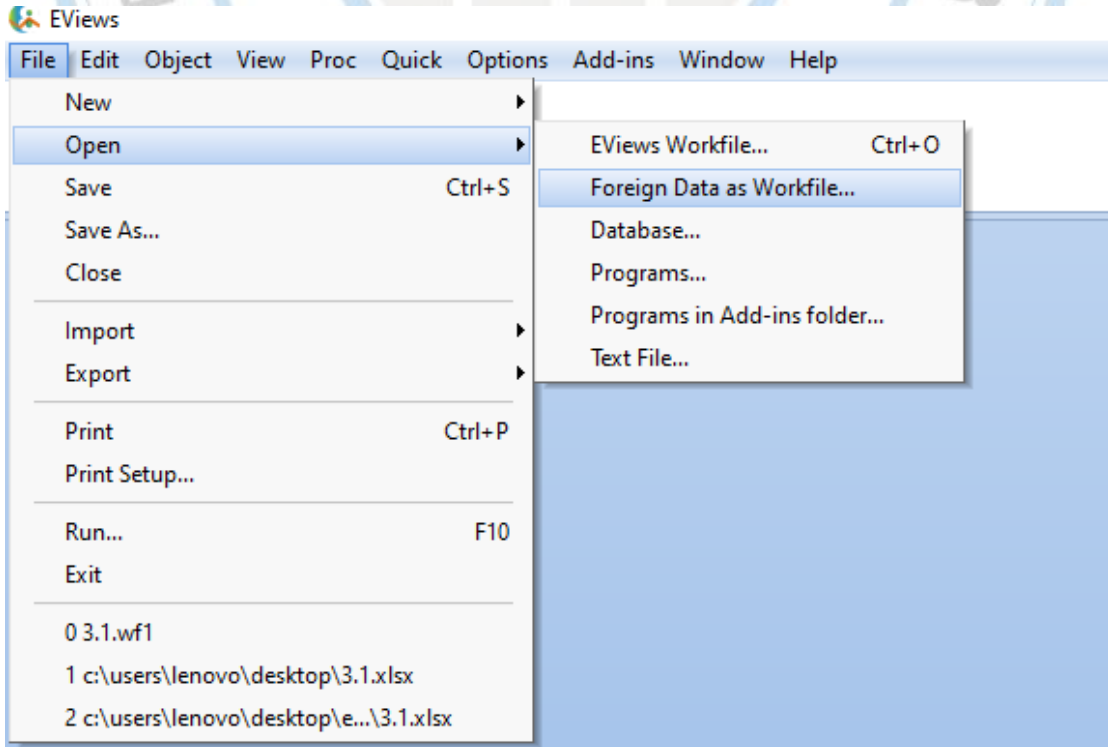
	Kesişim	X Değişkeni 1
Katsayılar	2,125016	0,319443
Standart Hata	0,57343	0,055478
t Stat	3,705801	5,758017
P-değeri	0,004069	0,000183
Düşük %95	0,84733537	0,19583021
Yüksek %95	3,402697	0,443055
Düşük 95,0%	0,847335	0,19583
Yüksek 95,0%	3,402697	0,443055

**Eviews ile Uygulama**

Views, Windows işletim sistemi için geliştirilmiş bir istatistik paket programıdır ve özellikle ekonometrik analizlerde yaygın olarak kullanılır. Quantitative Micro Software (QMS) firması tarafından geliştirilmiştir. İlk sürümü (1.0) 1994 yılında piyasaya sürülmüş olup, MicroTSP programının yerini almıştır. 2014 yılı itibariyle en son sürümü 8.0'dir. ( <https://tr.wikipedia.org/wiki/EViews>, 2024).

Eviews ile çözmeden önce 2 şekilde veriyi evIEWS dosyasına aktarılmaktadır. Örneğimizdeki gibi az gözlem sayısı ile yapılacak tahmin öncesi veriyi elle girilebilir. Şu adımlar ile giriş yapılabilir.

- 1. Adımda:** Önce gözlem sayısı belirlenir. Workfile structure type-> Unstructured/undated ve date range başlığı altında observations değerini gözlem değeriniz girilir. Excelden dosya çekilecekse open-> Foreign date as workfile den dosya seçilir.

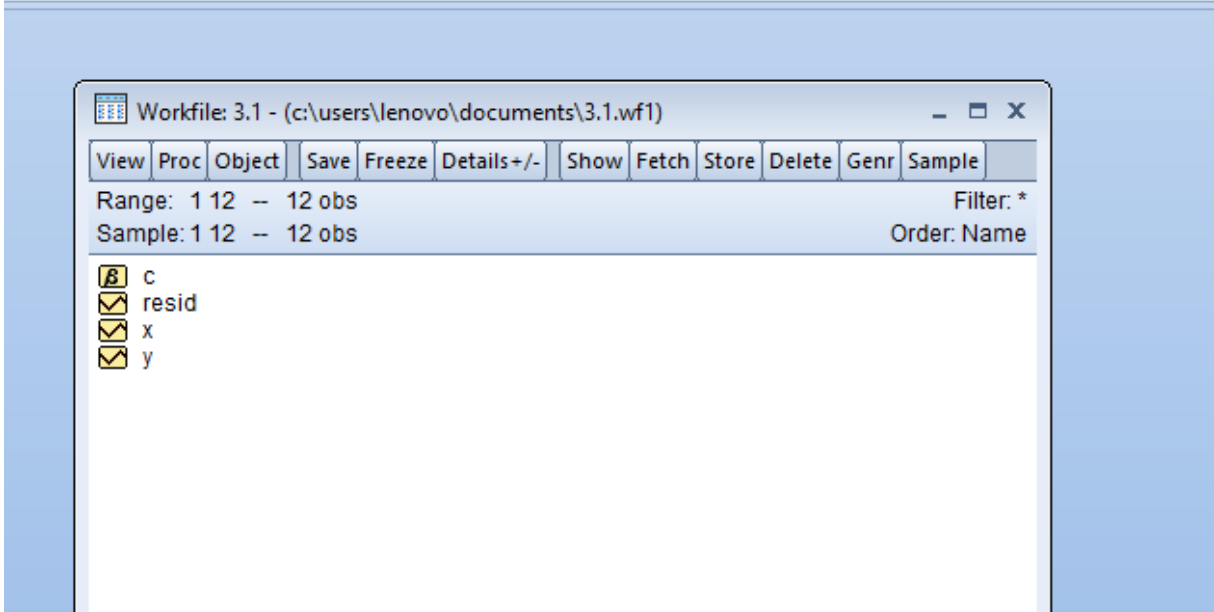


2. **Adımda:** Açılan pencerede sağa tıklayıp, New object-> Tybe of object altındaki Series -> name for object penceri altında bağımlı değişken için y yazılır. Aynı işlem adımları bağımsız değişken için de girilir ve bağımsız değişken yerine x yazılması tavsiye edilir.

EViews

File Edit Object View Proc Quick Options Add-ins Window Help

ls y c x



3. **Adımda:** Komut satırına

ls y c x kodu yazılır ve enter tuşuna basılır ve aşağıdaki sonuç penceresi açılır.

EViews - [Equation: UNTITLED Workfile: 3.1::Untitled\]

File Edit Object View Proc Quick Options Add-ins Window Help

View Proc Object Print Name Freeze Estimate Forecast Stats Resids

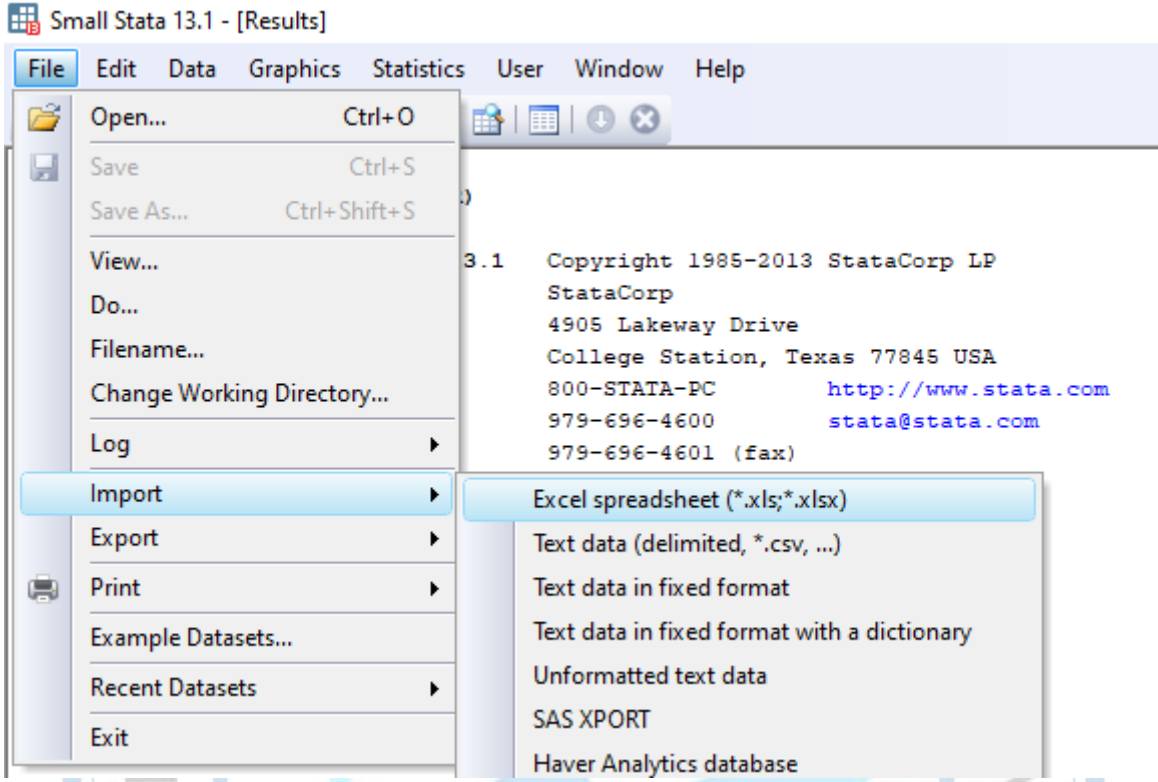
Dependent Variable: Y  
Method: Least Squares  
Date: 04/15/24 Time: 23:24  
Sample: 1 12  
Included observations: 12

Variable	Coefficient	Std. Error	t-Statistic	Prob.
C	2.125016	0.573430	3.705801	0.0041
X	0.319443	0.055478	5.758017	0.0002
R-squared	0.768276	Mean dependent var		5.000000
Adjusted R-squared	0.745103	S.D. dependent var		1.934848
S.E. of regression	0.976852	Akaike info criterion		2.942049
Sum squared resid	9.542400	Schwarz criterion		3.022867
Log likelihood	-15.65229	Hannan-Quinn criter.		2.912127
F-statistic	33.15476	Durbin-Watson stat		2.139441
Prob(F-statistic)	0.000183			

## STATA İle Uygulaması

Stata paket programı adımları ise;

1. **Adımda:** File -> İmport -> Excell spreadsheet -> Excel file -> Browse den dosya seçilir.

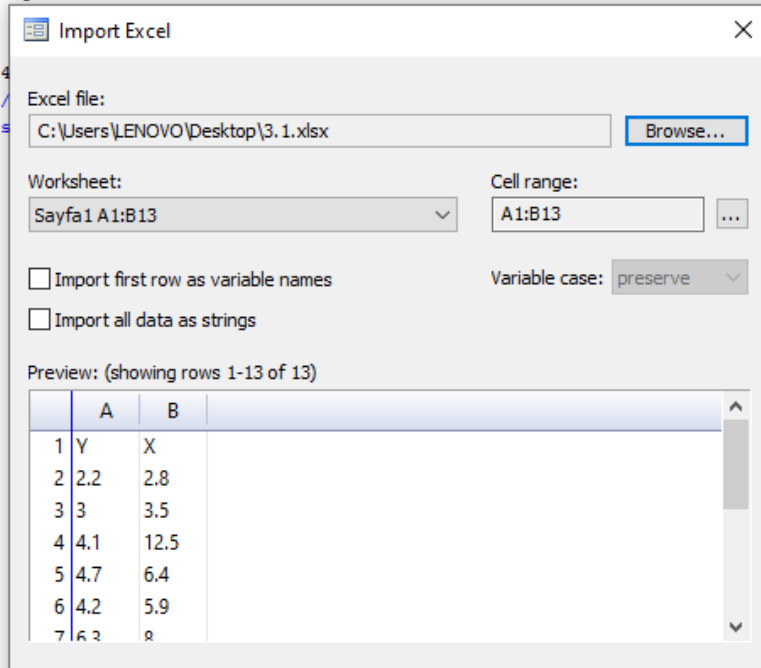


2. **Adımda:** Bağımlı ve bağımsız değişkenler seçilir.

```
1 Copyright 1985-2013 StataCorp LP  
StataCorp  
4905 Lakeway Drive  
College Station, Texas 77845 USA  
800-STATA-PC http://www.stata.com  
979-696-4600 stata@stata.com  
979-696-4601 (fax)
```

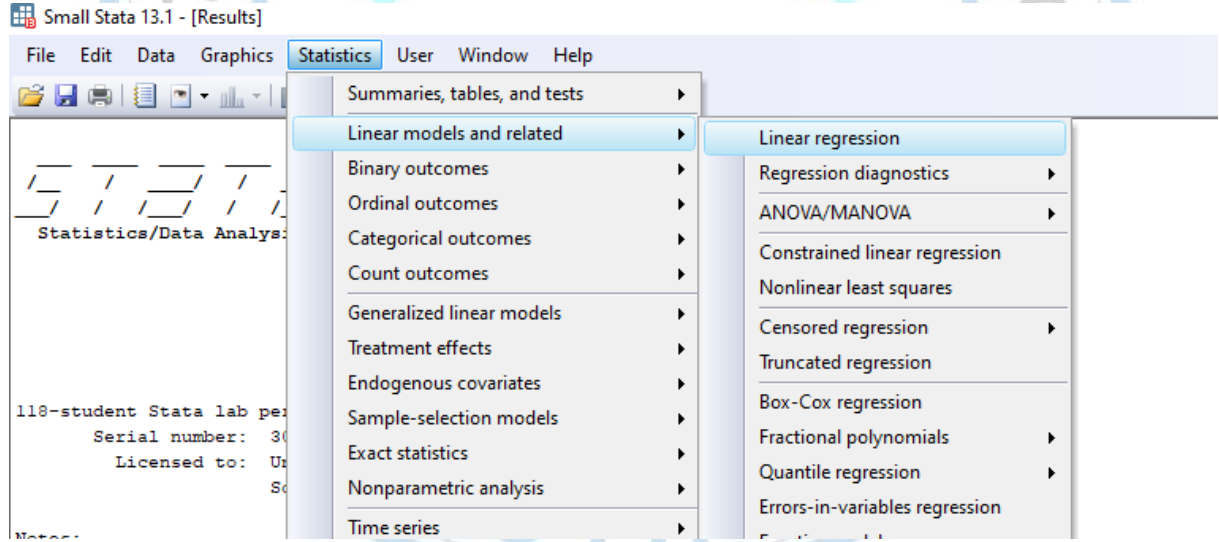
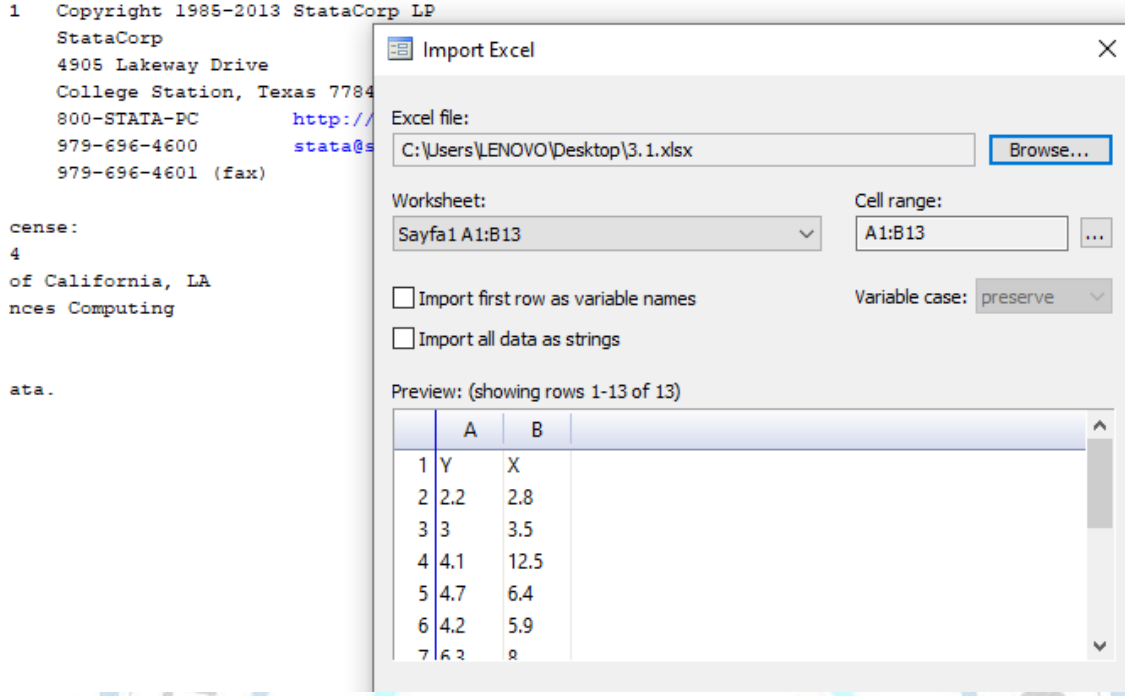
```
cense:  
4  
of California, LA  
nces Computing
```

```
ata.
```





3. **Adımda:** Statistics -> Linear models and related -> Linear regression -> Dependent variable ve Independent variables seçilir ve ok basılır. Aşağıdaki sonuç penceresi açılır.



Sonuç olarak aşağıdaki sonuç penceresi açılır.

```
. import excel "C:\Users\LENOVO\Desktop\STATA.xlsx", sheet("Sayfa1")  
. regress A B
```

Source	SS	df	MS	Number of obs =	12
Model	31.6376003	1	31.6376003	F( 1, 10) =	33.15
Residual	9.54239969	10	.954239969	Prob > F =	0.0002
Total	41.18	11	3.74363636	R-squared =	0.7683
				Adj R-squared =	0.7451
				Root MSE =	.97685

A	Coef.	Std. Err.	t	P> t	[95% Conf. Interval]
B	.3194427	.0554779	5.76	0.000	.1958302 .4430551
_cons	2.125016	.5734296	3.71	0.004	.8473354 3.402697

### SPSS Uygulaması

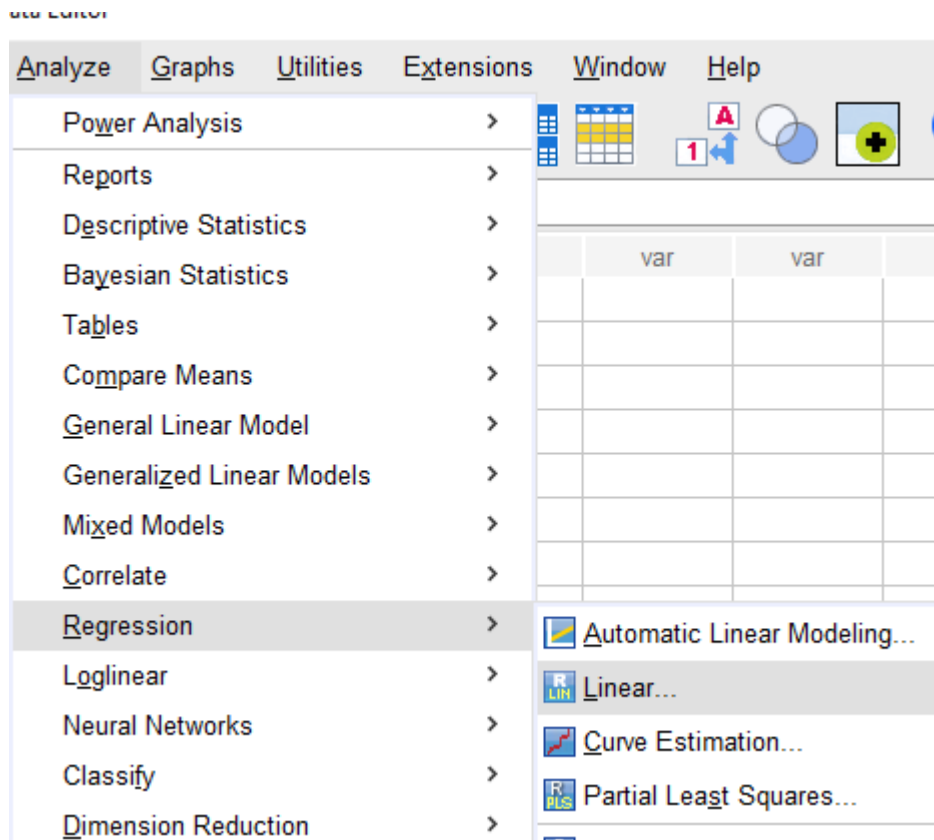
SPSS (Statistical Package for the Social Sciences), istatistiksel analiz için geliştirilmiş bir bilgisayar programıdır ve ilk sürümü 1968 yılında piyasaya sürülmüştür. 1968'den Mart 2009'a kadar bu program, ABD merkezli SPSS Inc. adlı bir şirket tarafından geliştirilip satılmıştır (<https://tr.wikipedia.org/wiki/SPSS>, 2024).

SPSS ile çözümüne baktığımızda;

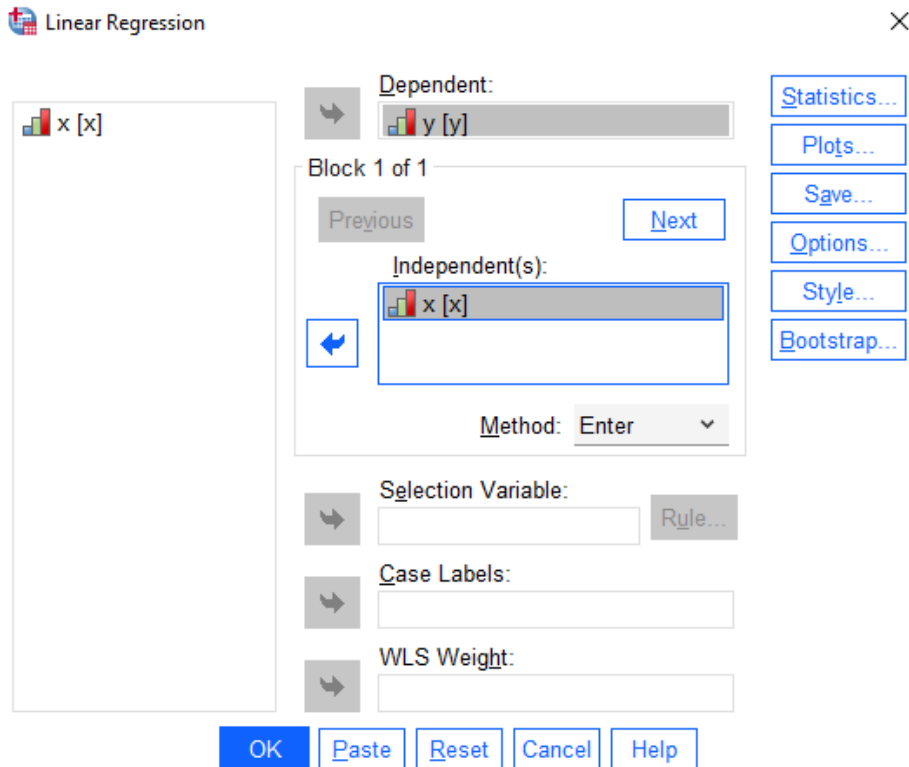
- 1. Adımda:** Data view sayfasından veri girişi yapılır.

	y	x	var
1	2	3	
2	3	4	
3	4	13	
4	5	6	
5	4	6	
6	6	8	
7	5	10	
8	9	21	
9	7	16	
10	4	7	
11	7	11	
12	4	5	

2. Adımda: Analyze -> Regression -> Linear



3. Adımda: Dependent : Bağımlı değişken, Independent:bağımsız değişken gönderilir.





Aşağıdaki sonuç penceresi açılır.

#### Coefficients<sup>a</sup>

Model	Unstandardized Coefficients		Standardized Coefficients	t	Sig.	
	B	Std. Error	Beta			
1	(Constant)	2,125	,573		3,706	,004
	x	,319	,055	,877	5,758	,000

a. Dependent Variable: y

#### ANOVA<sup>a</sup>

Model		Sum of Squares	df	Mean Square	F	Sig.
1	Regression	31,638	1	31,638	33,155	,000 <sup>b</sup>
	Residual	9,542	10	,954		
	Total	41,180	11			

a. Dependent Variable: y

b. Predictors: (Constant), x

#### Model Summary

Model	R	R Square	Adjusted R Square	Std. Error of the Estimate
1	,877 <sup>a</sup>	,768	,745	,97685

a. Predictors: (Constant), x

#### R İle Uygulaması

R, istatistiksel hesaplama ve grafikler için kullanılan bir yazılım ortamı ve programlama dilidir. R Foundation tarafından desteklenen ve GNU Projesi'nin bir parçası olan bu özgür yazılım, Yeni Zelanda'daki Auckland Üniversitesi'nden Ross Ihaka ve Robert Gentleman tarafından geliştirilmiştir. Şu anda R Geliştirme Çekirdek Ekibi tarafından geliştirilmeye devam edilmektedir. S programlama diline benzer olan R, S'nin bir uyarlaması olarak kabul edilir ve ilk olarak 1993 yılında piyasaya çıkmıştır ([https://tr.wikipedia.org/wiki/R\\_\(programlama\\_dili\)](https://tr.wikipedia.org/wiki/R_(programlama_dili)), 2024).

R ile çözüm adımlarına baktığımızda;

- 1. Adımda:** Bağımlı ve bağımsız veriler girilir.
- 2. Adımda:** `Veri <- data.frame ( bagimli, bagimsiz)`
- 3. Adımda:** `Model <- lm ( bagimli ~bagimsiz, data = veri)`
- 4. Adımda:** `Summary(model)` kodu girilir ve aşağıdaki sonuç penceresi açılır.

```
> # Verileri oluşturun
> bagimli <- c(2.2, 3, 4.1, 4.7, 4.2, 6.3, 4.6, 8.8, 7.3, 4.4, 6.9, 3.5)
> bagimsiz <- c(2.8, 3.5, 12.5, 6.4, 5.9, 8, 9.7, 20.6, 15.9, 6.7, 11.3, 4.7)
>
> # Verileri bir veri çerçevesinde birleştirin
> veri <- data.frame(bagimli, bagimsiz)
>
> # Basit doğrusal regresyon modelini oluşturun
> model <- lm(bagimli ~ bagimsiz, data = veri)
>
> # Model özetini görüntüleyin
> summary(model)

Call:
lm(formula = bagimli ~ bagimsiz, data = veri)

Residuals:
    Min       1Q   Median       3Q      Max
-2.01805 -0.33820  0.09516  0.27534  1.61944

Coefficients:
            Estimate Std. Error t value Pr(>|t|)
(Intercept)  2.12502    0.57343   3.706 0.004069 **
bagimsiz      0.31944    0.05548   5.758 0.000183 ***
---
Signif. codes:  0 '***' 0.001 '**' 0.01 '*' 0.05 '.' 0.1 ' ' 1

Residual standard error: 0.9769 on 10 degrees of freedom
Multiple R-squared:  0.7683,    Adjusted R-squared:  0.7451
F-statistic: 33.15 on 1 and 10 DF,  p-value: 0.0001831
```

## Python İle Uygulama

Python, nesne yönelimli, yorumlamalı, modüler ve etkileşimli bir yüksek seviyeli programlama dilidir.

1980'lerin sonunda ABC programlama diline alternatif olarak tasarlanan Python'un ilk sürümü 2000 yılında Python 2.0 olarak yayınlanmıştır. 2008'de piyasaya sürülen Python 3.0, önceki sürümle tam uyumlu değildir, bu nedenle Python 2.x ile yazılan kodların Python 3.x'te çalışabilmesi için değiştirilmesi gerekmektedir. Python 2.7.x serisi sürümlerinin ardından, Python 2'nin resmi geliştirilme süreci 1 Ocak 2020'de sona ermiştir. Python 2.x desteğinin bitmesinin ardından, Python 3.7.x ve sonraki sürümlerin geliştirilmesine devam edilmektedir.

(<https://tr.wikipedia.org/wiki/Python>, 2024)

**Adımda:** import numpy as np

from sklearn.linear\_model import LinearRegression kütüphanesi yüklenir.

**1. Adımda:** Bağımlı ve bağımsız değişkenler girilir.

```
x = np.array(["2.8", "3.5", "12.5", "6.4", "5.9", "8", "9.7", "20.6", "15.9", "6.7", "11.3", "4.7"]).reshape(-1, 1)
```

```
y = np.array(["2.2", "3", "4.1", "4.7", "4.2", "6.3", "4.6", "8.8", "7.3", "4.4", "6.9", "3.5"])
```

**2. Adımda:** Lineer Regresyon Modeli Oluşturma ve Eğitime için aşağıdaki kod yazılır.

```
model = LinearRegression()
```

```
model.fit(x, y)
```

**3. Adımda:** Eğim (slope) ve Kesme Noktası (intercept) Değerlerini Alın

```
slope = model.coef_[0] intercept = model.intercept_
```

```
print("Eğim (slope):", slope)
```

```
print("Kesen Nokta (intercept):", intercept) girilir ve aşağıdaki sonuç penceresi açılır.
```

```
import numpy as np
from sklearn.linear_model import LinearRegression

# Verileri düzeltme
x_str = np.array(["2,8", "3,5", "12,5", "6,4", "5,9", "8", "9,7", "20,6", "15,9", "6,7", "11,3", "4,7"])
y_str = np.array(["2,2", "3", "4,1", "4,7", "4,2", "6,3", "4,6", "8,8", "7,3", "4,4", "6,9", "3,5"])

x = np.array([float(value.replace(',','.')) for value in x_str]).reshape(-1, 1)
y = np.array([float(value.replace(',','.')) for value in y_str])

# Linear Regresyon
model = LinearRegression()
model.fit(x, y)

slope = model.coef_[0]
intercept = model.intercept_

print("Eğim (slope):", slope)
print("Kesen nokta (intercept):", intercept)
```

```
Eğim (slope): 0.31944265256095977
Kesen nokta (intercept): 2.1250161269513606
```

## Sonuç

Bilimsel açıdan beklentinin farklı paket programıyla çözümü olsa da aynı sonuçlara ulaşılabileceği beklenir. Baktığımız da farklı paket programların dan aynı sonuçlara ulaşılmıştır. Algoritmalarında az bir farklılık olduğu görülmektedir. Farkın sonuç pencerelerinde veya virgülden sonra basamak sayıları ve zaman karmaşıklığı altında incelerse hangi program ile daha hızlı çözüme ulaşılabileceği tartışılabilir.

## Kaynakça

- Güriş, S., & Akay, E. Ç. (2018). Ekonometri :Temel Kavramlar. İstanbul: Der Kitabevi Yayınevi Ve Dağıtım Pazarlama Ve Limited Şirketi.
- <https://Tr.Wikipedia.Org/Wiki/Eviews>. (2024, 4 18). Wikipedia: <https://Tr.Wikipedia.Org/Wiki/Eviews> Adresinden Alındı
- [https://Tr.Wikipedia.Org/Wiki/Microsoft\\_Excel](https://Tr.Wikipedia.Org/Wiki/Microsoft_Excel). (2024, Nisan 18). Wikipedia: [https://Tr.Wikipedia.Org/Wiki/Microsoft\\_Excel](https://Tr.Wikipedia.Org/Wiki/Microsoft_Excel) Adresinden Alındı
- <https://Tr.Wikipedia.Org/Wiki/Python>. (2024, 4 18). Wikipedia: <https://Tr.Wikipedia.Org/Wiki/Python> Adresinden Alındı
- [https://Tr.Wikipedia.Org/Wiki/R\\_\(Programlama\\_Dili\)](https://Tr.Wikipedia.Org/Wiki/R_(Programlama_Dili)). (2024, 04 19). Wikipedia: [https://Tr.Wikipedia.Org/Wiki/R\\_\(Programlama\\_Dili\)](https://Tr.Wikipedia.Org/Wiki/R_(Programlama_Dili)) Adresinden Alındı
- <https://Tr.Wikipedia.Org/Wiki/Spss>. (2024, 04 19). Wikipedia: <https://Tr.Wikipedia.Org/Wiki/Spss> Adresinden Alındı



## Investigation of Flowcharts and Decision Trees for Classification of Statistical Techniques

**Muharrem SENGÜL<sup>1</sup>, Ergül Demir<sup>1\*</sup>**

<sup>1</sup> Ankara University, Faculty of Educational Sciences, Educational Measurement and Evaluation, 06590, Ankara, Türkiye

\*Corresponding author e-mail: erguldemir@ankara.edu.tr

### ***Abstract***

*The aim of this study is to describe and discuss the unique aspects, limitations, similarities and differences of different flow charts and decision trees available to researchers for the classification of statistical techniques in basic sources, in terms of classification approach and format, scope and general systematics. In this descriptive research, flow charts and decision trees in five primary sources, written by field experts, internationally qualified, with a high number of citations and academic impact size, containing flow charts or decision trees for the classification of statistical techniques, were examined. In this review, first of all, the determined flow charts and decision trees are described in terms of their general structures, classification approaches and scopes. Afterwards, theoretical discussions were conducted in line with the research objectives and questions, creating a logical integrity. As a result of this review and discussions, it has been seen that there are two distinct approaches to the classification of statistical techniques; (1) classification approach focused on the characteristics of variables and relationships between variables and (2) classification approach focused on the research question. The classifications produced according to both approaches can also help researchers. However, it is seen that focused on the research question classifications can provide a stronger classification of statistical techniques and, accordingly, include a greater number of techniques. In addition, these classifications provide the opportunity to integrate the methodological infrastructure of the research with the data structure and statistical infrastructure. It seems that in order to benefit from such classifications effectively and efficiently, it is necessary to have at least a level of statistical competence that can define the variable structure and characteristics and a methodology competence that can define the form of the research question.*

**Keywords:** Variable type, Research question, Statistical tests, Inferential statistics, Hypothesis tests.

### **INTRODUCTION**

It is important for researchers to decide on the statistical analysis technique they will use in a research in the expected time and correctly in terms of rapid conclusion of the research. Researchers make efforts to decide on the appropriate analysis technique in their research (Murray and Knowles, 2014). In order for the process of deciding on the appropriate statistical analysis technique to proceed quickly with this effort, it is necessary to first have sufficient knowledge about the type of variable(s) (quantitative / qualitative), scale structure (continuous / discrete) and causality situations (independent / dependent). For relatively more complex and advanced analyses, it is also necessary to consider whether the independent variable is a selected (chosen), manipulated, moderator or mediator variable. In this context, the structure of the variable(s) is among the primary and fundamental determinants in determining appropriate statistical techniques.

Although determining the statistical technique to be used by researchers depends on the research question in general and the variable in particular, many statistical analysis techniques must be mentally

filtered at once in order to select the appropriate type of statistical analysis. Simultaneous evaluation of statistical techniques is a field of expertise. However, for researchers who do not have a field of expertise, carrying out this process in a healthy and effective way is possible with familiarity and applying relatively more statistical analysis, that is, with a certain amount of experience (Field, 2019). It is clear that determining the correct statistical technique by the researcher requires field expertise or knowledge. However, determining the appropriate statistical analysis technique can be time-consuming for researchers who are not experts in the field or who do not have a certain background, and this time spent may not guarantee the determination of the appropriate statistical technique. In this case, there are some guides in the literature in the form of different classifications and flow charts that can help researchers regarding which statistical analysis technique to use. Although each flow chart has its own unique aspects, it also has some limitations. In this context, discussing the advantages and disadvantages of the use of such flow charts and examining these charts in detail for researchers who do not have expertise or sufficient experience in statistical analysis techniques reveal the problem situation of this research.

The purpose of this research is to describe and discuss the unique aspects, limitations, similarities and differences of different flow charts and decision trees available to researchers for the classification of statistical techniques, in terms of classification approach and format, scope and general systematics. In line with these discussions, it is also aimed to provide a general perspective on the integration of these different classifications. In this context, the research questions to be answered are as follows:

- What are the classification approaches, systematic structures, scope and limitations of different flow charts and decision trees for the classification of statistical techniques?
- What are the basic indicators taken into account as a basis for classification? What is the flow order of these indicators?
- What are the similarities and differences between these classifications?

## **MATERIAL AND METHODS**

The analysis unit of this research is books that are widely used and recognized and are basic and primary sources. The flow charts and decision trees in these specially defined books were systematically examined and discussions were conducted in line with the determined research questions. In this context, it is considered that this research can be defined as a descriptive research. Descriptive research is defined as a type of research in which a certain situation is described as carefully and fully as possible (Fraenkel et al., 2023).

### *The Collection of the Data*

As the data source in this research, the books that are well-known and widely used and are basic and primary sources, containing flow charts and decision trees for the classification of statistical analysis techniques, were used. Although there are many basic reference books in the relevant literature, resources containing flow charts and decision trees for the classification of statistical techniques are limited. For this reason, primary sources that (i) contain a flow chart or decision tree for the classification of statistical techniques, (ii) prepared by field experts, (iii) are of international quality, (iv) have a high number of citations and academic impact size were taken into consideration as data sources. In this context, “Discovering statistics using IBM SPSS statistics” (Field, 2018), “Multivariate data analysis (Hair et al., 2019), “Advanced and multivariate statistical methods” (Mertler et al., 2019), “Fundamentals of Biostatistics” Flowcharts and decision trees in (Rosner, 2016) and “Using Multivariate Statistics” (Tabachnick and Fidell, 2019) were examined.

### *Statistical Analysis*

In the data analysis processes, first of all, the determined flowcharts and decision trees were described in terms of their general structures, classification approaches and scopes. Afterwards, theoretical discussions were conducted in line with the research objectives and questions, creating a logical integrity.

### **RESULTS**

Field (2018) generally envisages an inductive classification approach within a structured flow, with variables and variable structures as the starting point. Accordingly, based on the variables in the research, respectively (i) the number of dependent variables, (ii) the type of dependent variable, (iii) the number of independent variables, (iv) the type of independent variable, (v) the number of categories if the independent variable is categorical and (vi) the related variables of the samples. It proposes a flowchart indicating the statistical analysis technique (parametric and non-parametric) to be used after questioning whether or not there is a correlation. This proposed flowchart includes multivariate as well as univariate techniques. However, the scope is limited to general linear models and some of their nonparametric equivalents. In addition, many powerful techniques such as discriminant function analysis, cluster analysis, exploratory and confirmatory factor analyses, multidimensional scaling, (multiple) correspondence analysis, structural equation models are not included.

Hair et al. (2018) generally adopted a classification approach according to a flow chart focusing on the dependency situations between variables before the structure of the variables. When the dependency between variables is taken as a starting point, a classification into subgroups for statistical techniques can also be provided. The main limitation of this flowchart, which can also be considered as a decision tree, in terms of scope is that it is aimed at multivariate statistical techniques. Accordingly, in determining the appropriate multivariate statistical technique; The appropriate multivariate statistical analysis technique can be achieved by answering three questions: i) separating variables into dependent and independent based on a theory, ii) how many variables can be considered as dependent variables in the analysis, iii) whether dependent and independent variables are continuous or discrete.

The first question in this flow is whether to use dependency or interdependence techniques. Dependency techniques are techniques in which some variable(s) are described as dependent variables and others as independent variables (for example, MANOVA). Addition techniques; (i) simple equality models as linear models (classical general linear models such as regression, ANOVA, discriminant function analysis, hierarchical models and other generalized linear models) and (ii) equation systems (SEM [structural equation models] and PLS [partial least squares]). Interdependence techniques are defined as techniques in which no distinction is made between dependent and independent variables (for example, EFA).

Dependency techniques are categorized in two ways, according to the number of dependent variables (1 or  $\pm 2$ ) and whether the dependent variable is continuous or categorical. Dependency techniques are directed to statistical techniques within the given framework. Since interdependence techniques analyze all variables simultaneously without distinguishing between dependent and independent, the distinction of these techniques is classified in terms of variable, individual and object. For example, while EFA and CFA techniques are used to classify variables, cluster analysis is also used to classify individuals along with the variable. Details of multivariate analysis of variance techniques are not provided.

Mertler et al. (2022) presents two separate classifications that focus on both the variable structure/characteristics and the research problem/question. As a basic principle, it is evaluated that if a correct and appropriate research question is determined, it can be easily decided which statistical



technique to use, and a flow chart is suggested for this purpose. On the other hand, a table classifying statistical techniques depending on the dependent-independent variable structure is also given for descriptive purposes.

1. Variable-oriented classification is limited to general linear models (GLM) only. The term “general” in GLM refers to its ability to accommodate quantitative distinctions representing continuous measures in regression analysis and categorical variables representing experimental conditions in ANOVA (Rutherford, 2001). According to this classification, the flow consists of the following stages:
  - Determining the variables in the research question
  - Definition of dependent, independent and covariate variables
  - Determining the scale level of all variables and determining the number of categories if there is a categorical variable.
  - Using the statistical test table to determine the analysis of interest.
2. The classification focused on the research problem is more comprehensive than the previous classification. However, it does not include many techniques such as cluster analysis, multidimensional scaling, (multiple) correspondence analysis and SEM. In this classification, they state that the appropriate statistical technique can be determined depending on the type of research question (relationship between variables, significant group differences, predicting group membership, and revealing the structure). They proposed a decision tree for this and the stages are determined as follows:
  - Determining the variables in the research question
  - Defining variables as dependent, independent and covariate variables
  - Determining the scale level of all variables and determining the number of categories if there is a categorical variable.
  - Determining the purpose of the research. Researchers have given some tips to determine the purpose of the research:
    - If all dependent and independent variables are continuous, the aim is to determine the relationship.
    - If the dependent variable is continuous and the independent variable is categorical, the aim is to determine the difference between groups.
    - If the dependent variable is categorical, the goal is to estimate group membership.
  - Deciding on the statistical analysis technique using the decision tree.

Rosner (2016) also proposes a classification generally focused on variable structure and category. Accordingly, researchers can follow a flow according to (i) number of variables, (ii) distribution type of data (normal, binomial and poisson) and (iii) variable type (number of categories if categorical). The decision tree for this classification was created comprehensively, starting with a single variable and classifying it to include all variance models in multivariate statistics. It reveals appropriate statistical analyzes in detail, taking into account the relationship between variables and the difference between groups. However, no recommendations are given for predicting group membership (except for logistic regression), exploring structure, and longitudinal studies.

Tabachnick and Fidell (2019) propose a classification that is clearly and emphatically focused on the research problem and question. Accordingly, they state that the most important criterion when deciding on the appropriate statistical analysis technique is the main research question to be answered. They grouped research questions under five headings: Relationship(s) between variables, difference(s) between groups, estimation of group membership, exploratory/confirmatory of structure, and examination of time-dependent variability (longitudinal/time series). After determining the research question, respectively; They present a flowchart indicating the number and type of dependent variables, the number and type of independent variables, the appropriate statistical analysis technique and the purpose of using this technique. This flowchart provides a comprehensive classification of multivariate techniques. However, some powerful techniques such as cluster analysis, multidimensional scaling and (multiple) correspondence analysis are not included.

### **Basic Indicators and Flow Systematics Considered in Classification**

The general structure and characteristics of the flow charts / decision trees examined show that basically two classification approaches are adopted. These are (i) classification approach focused on variable structure and characteristics and (ii) classification approach focused on the research problem and question.

The classifications in the first group focus directly on the structure of variables and the relationships between variables. In these classifications variable types, scale levels, dependent-independent relationship status of variables, as well as sample structure and distribution patterns of measurements, are the variables taken into account in the classification. These classifications include a limited number of techniques due to the abundance of possible combinations. Generally, powerful techniques such as cluster analysis, discriminant function analysis, and structural equation models may remain excluded from classification.

Since the second group of classifications focuses on the initial research problem and question, it can classify statistical techniques into subgroups more clearly and powerfully. In these classifications, the purposes for which statistical techniques are used and the situations in which they can be used can also be described. A broad scope can be defined to include both univariate and multivariate techniques. These classifications also take into account the variable structure and characteristics, although not in the initial stages, but in the advanced stages. In this context, first the research question, then the structure of the variables and indicators of the characteristics of the relationships between the variables are taken into consideration.

In general, a flow structuring can be seen in these classification models, taking into account (i) the research question, (ii) the dependent variable structure, (iii) the independent variable structure and (iv) the sample and distribution structure, respectively.

### **Similarities and Differences**

It can be seen that similar indicators regarding the variable structure are taken into account in the classification of statistical techniques in different flow charts and decision trees. In this context, dependent-independent variable definitions, the number, type and scale levels of these variables are included step by step. Some flow charts and decision trees may include additional stages and details depending on the dependency relationships between variables or the distribution structure of measurements for the variables. In classifications focused on the research question, the research question classifications are generally similar. Depending on the differences in scope, flowcharts and decision trees that take into account a greater number of research questions and situations can be seen.

## DISCUSSION AND CONCLUSION

In this study, flow charts and decision trees for the classification of statistical techniques in a total of five books, which are basic and primary sources and are well-known and widely used in the relevant literature, were examined. The general approaches, scope and content of these classifications, as well as their descriptions according to the indicators taken into account, are given in Table 1.

**Table 1.** Different flowcharts for classification of statistical techniques and general structure of decision trees

Books	General approach	Coverage	Indicators taken into account in the classification					
			Research question	Number of variables	Variable type	Covariate variable	Assumption	Nonparametric technique
Field	Focused on variable structure	General linear models	-	+	+	+	+	+
Hair et al.	Focused on the research question	Multivariate models (Dependent and inter-dependent)	-	+	+	-	-	-
Mertler et al.	Focused on the research question	General linear models	+	+	+	+	-	-
Rosner	Focused on variable structure	General linear models (Mostly univariate models)	-	+	+	-	+	+
Tabachnick and Field	Focused on the research question	Multivariate statistics	+	+	+	+	-	-

As seen in Table 1, there are two distinct approaches to the classification of statistical techniques. These are (1) the classification approach focusing on the characteristics of variables and the relationships between variables and (2) the classification approach focusing on the research question. Despite some differences in scope, both approaches consider variable types, scale levels and dependence-independence relationships between variables as the main indicators for classification. Within the research question-oriented classifications, the research questions considered are also similar.

These classifications, which include both univariate and multivariate techniques, generally cover techniques that are widely recognized and used. However, some powerful and specialized techniques such as cluster analysis, discriminant function analysis, correspondence analysis, structural equation models are not included in some classifications. Accordingly, such flowcharts and decision trees are limited in scope and content. As expected, these flowcharts and decision trees can only cover a certain number of techniques. Potentially, focused on the research question classifications can provide a more robust classification of statistical techniques and therefore include a larger number of techniques.

Both focused on variable structure classifications and focused on research question classifications can help researchers to determine the appropriate statistical technique. However, focused on research question classifications provide the opportunity to integrate the methodological infrastructure of the research with the data structure and statistical infrastructure. In this respect, it may provide an advantage. In terms of research systematics, it is expected to pay attention not only to the variable structure but also to the methodological background of the research in deciding on the appropriate statistical technique.



The flowcharts and decision trees analyzed in this study illustrate typical forms of classification. These and similar classifications can help researchers to identify appropriate statistical techniques. On the other hand, these classifications only cover a limited number of techniques according to a limited number of indicators and flow stages. Therefore, the main purpose is to identify the structural and characteristic differences of certain statistical techniques rather than their use in determining the appropriate statistical technique. The use of such flowcharts and decision trees needs to be mindful of this limitation.

Whether flowcharts for the classification of statistical techniques are used to determine the appropriate statistical technique or to examine the general characteristics and differences of these techniques from others, this utilization depends on a certain level of statistical and methodological competence. The effective use of such flowcharts and decision trees depends on the basic competence of researchers to describe the structure and characteristics of their variables. The use of research question-oriented classifications, on the other hand, requires this statistical competence as well as a methodological competence to define the general form of their problem situations and research questions.

### References

- Field, A. (2019). *Discovering statistics using IBM SPSS statistics* (5th ed.). SAGE Publications.
- Fraenkel, J., Wallen, N., & Hyun, H. (2023). *How to design and evaluate research in education* (11th ed.). McGraw-Hill Education.
- Hair, J. F., Black, W. C., Babin, B. J., & Anderson, R. E. (2019). *Multivariate data analysis* (8th ed.). Cengage Learning.
- Mertler, C. A., Vannatta, R. A., & Lavenia, K. N. (2019). *Advanced and multivariate statistical methods* (7th ed.). Routledge.
- Murray, J. & Knowles, E. (2014). Developing students' thought processes for choosing appropriate statistical methods. *Journal of Education for Business*, 89(8), 389-395. <https://doi.org/10.1080/08832323.2014.919896>
- Rosner, B. (2016). *Fundamentals of biostatistics* (8th ed.). Cengage Learning.
- Rutherford, A. (2001). *Introducing ANOVA and ANCOVA: A GLM approach*. Sage Publications.
- Tabachnick, B. G. & Fidell, L. S. (2019). *Using multivariate statistics* (7th ed.). Pearson Education.

### Acknowledgment

This research was carried out within the scope of the project numbered 223K382 supported by TUBITAK.

### Conflict of Interest

The authors have declared that there is no conflict of interest.

### Author Contributions

this study was conducted and written together by both writers collaboratively.

**Marka Tercihini Etkileyen Faktörler: Ankara Hacı Bayram Veli Üniversitesi  
Ekonometri ve İktisat Bölümü Lisans Programı Öğrencileri Üzerine Bir Uygulama**

**Muhammed İkbal YILMAZ<sup>1\*</sup>, Özge YILDIZ<sup>1</sup>, Şahika GÖKMEN<sup>2,3</sup>**

<sup>1</sup>Lisans Öğrencisi, Ekonometri Bölümü, İktisadi ve İdari Bilimler Fakültesi, Hacı Bayram Veli Üniversitesi, 06500, Ankara, Türkiye.

<sup>2</sup>Doç. Dr., Ekonometri Bölümü, İktisadi ve İdari Bilimler Fakültesi, Hacı Bayram Veli Üniversitesi, 06500, Ankara Türkiye.

<sup>3</sup>Researcher, Statistics Department, Uppsala University, Uppsala, Sweden.

\*\*Sorumlu yazar e-mail: muhammed.yilmaz@hbv.edu.tr

**Özet**

21. yüzyılda üniversite öğrencileri, özellikle giyim ve tekstil sektörlerinde önemli bir tüketici grubu haline gelmiştir. Bu değişim, işletmelerin pazarlama stratejilerini öğrenci odaklı hale getirmektedir. Literatürde, genç tüketicilerin tercihlerini anlamak için Marka Tercihi (MT), Marka Sadakati (MS) ve Marka Güveni (MG) kavramları üzerine birçok çalışma yapılmış olup, pazarlama camiasında bu konulara ilişkin çeşitli araştırmaların olduğu görülmektedir. Türkiye'nin başkentindeki sosyal bilimler üniversitelerinde bu konuda yapılan çalışmaların azlığı dikkate alınarak, bu çalışma Ankara Hacı Bayram Veli Üniversitesi öğrencilerinin Marka Tercihlerini araştırmayı amaçlamıştır. Ekonometri ve İktisat bölümü öğrencilerinden çevrimiçi ve yüz yüze anketlerle veri toplanmış ve elde edilen veriler tanımlayıcı istatistikler, bağımsızlık analizleri ile değerlendirilmiştir. Öğrencilerin hesaplanan ortalama tercih, sadakat ve güven puanları, her iki bölüm üzerinden davranışların benzerlikleri ve farklılıkları gözlemlenerek korelasyonları incelenmiştir.

**Anahtar Kelimeler:** Marka Tercihi, Marka Sadakati, Marka Güveni, Snob Davranış, Saha Araştırması.

**1. GİRİŞ**

Üniversite öğrencileri, teknolojiyi ve sosyal medyayı takip ederek markaları tercih eden bir tüketici grubudur. Çevrimiçi alışveriş platformları, güven inşa ederek markaların tanınırlığını ve öğrencilerin kararlarını şekillendirmektedir. Türkiye'de tekstil ve hazır giyim sektöründe ithalatın payının artması, uluslararası rekabetin yükselmesi bu sektörlerin dış pazarlarda başarılı olmasını sağlayarak üniversite öğrencilerini de içine alan önemli bir sektörü temsil etmektedir (Seock & Norton, 2007:571-586; Elena, vd., 2008:81-113; Muniady, vd., 2014:18; Sarkar, vd., 2015; Godey, vd., 2016: 5833-5841; Ahmed, vd., 2021:31-43; Bozkurt, 2021:567-579; T.C. Sanayi ve Teknoloji Bakanlığı, 2021:6-43; T.C. Sanayi ve Teknoloji Bakanlığı, 2023; Mayasari, vd., 2023:147-165). Bu bakımdan üniversite öğrencilerinin marka tercihlerinin birçok faktörden etkilendiği literatürde yer alan pek çok çalışmaya bağlı olarak da söylenebilir. Bu çalışmalar incelendiğinde, herhangi bir markanın tercihi aşamasında öğrencilerin maddi durumlarını, üründe aranan kriterleri, tercih aşamasını etkileyen benzer diğer faktörlerin etkisini göz önünde bulundurduğu belirtilmiştir (Yayla, vd., 2018; Anafi, 2021; Durmuş & Battal, 2018; Kahraman & Dağlı, 2019:381-398).

Marka üzerine gelişen kavramsal literatür ele alındığında; Aaker (1996:42-51-408)'ın marka değerini marka bilinirliği, sadakati ve algılanan kalite gibi dört başlık altında incelerken; Stern (2006:216-223)'in ise marka terimini denotatif olarak incelediği, buna karşın Oliver (2010)'ın marka sadakatini duygusal açıdan proaktif ve durumsal sadakat olarak ikiye ayırdığı görülmektedir. Tüm bu yaklaşımlar, marka tercihi, marka sadakati ve marka güveni kavramlarının birbirleriyle ilişkili olduğunu, marka sadakati ile marka bağlılığı arasında marka güveninden etkilenen güçlü bir ilişki olduğunu vurgulamaktadır (Keller,

1956; Elena & Jose, 2001: 1238-1258; Romano, 2003). Demografik özelliklerin önemi tartışılmazken, öğrencilerin alışkanlık ve kolaylık faktörleriyle belli markalara sadakat göstererek alışveriş tercihlerini yönlendirdiği de çeşitli çalışmalarda ele alınmıştır (Guest, 1944:16; Alimen & Cerit, 2010:538-558; Ebrahim, 2013; Sharp, 2017:76-389; Nistor, 2019:41-59).

Tüm bu durumların yanı sıra, öğrencilerin giyim alışverişinde farklı kriterleri olsa da etik tüketim anlayışıyla bütçelerini dikkatlice yönlendirmeleri beklenmektedir. Bu beklenti, özellikle üniversite öğrencileri dikkate alındığında İktisat, Ekonometri gibi bölüm öğrencilerinin iktisadi beklentilere de daha uygun davrandığı düşüncesini ortaya çıkarmaktadır. Bu bağlamda bu çalışmada, Ankara Hacı Bayram Veli Üniversitesi'nin İktisat ve Ekonometri bölümlerinde eğitim gören öğrencilerin Marka Tercihleri (MT), Marka Sadakatleri (MS) ve Marka Güvenleri (MG) arasındaki ilişki yapıları, benzerlikleri ve farklılıkları incelenmiştir. Bu alanda üniversite öğrencilerini odağa alarak yapılan çalışmalar, uygulanabilecek politikaların tanımlanması açısından yol gösterici olabilmektedir. Dolayısıyla bu çalışmayla da Türkiye'deki üniversite öğrencilerinin marka tercihi, marka sadakati ve marka güveni kavramlarına yaklaşımlarının analitik bir yaklaşımla ele alınarak marka temsilcilerine ve politika üreticilerine yol gösterebileceği düşünülmektedir. Literatürden farklı olarak söz konusu çalışmanın İktisat ve Ekonometri Bölüm öğrencilerine uygulanıyor olmasının bir sonucu olarak, üniversite gençliğinin bu alandaki iktisadi davranışlarının arasındaki farklarının da görülebilecek olması çalışmanın özgünlüğünü vurgulamaktadır.

Çalışma, Giriş bölümü ile birlikte toplam dört bölümden oluşmaktadır. Giriş bölümünü takiben ikinci bölümde Veri Toplama Süreci ve Anket Kapsamı ele alınmış olup; üçüncü bölümde Bulgular ve son olarak dördüncü bölümde ise bulguların değerlendirildiği Sonuç bölümü yer almaktadır. Araştırmanın ilerleyen bölümlerinde ölçüklerin kısaltmaları kullanılmıştır.

## 2. VERİ TOPLAMA SÜRECİ VE ANKET KAPSAMI

### 2.1. Veri Toplama Süreci

Araştırmada veri toplama yöntemi olarak anketler kullanılmıştır. Ankara Hacı Bayram Veli Üniversitesi İktisadi ve İdari Bilimler Fakültesi'nde, 2023-2024 bahar döneminde Ekonometri ve İktisat lisans programlarını takip eden öğrencilerden oluşan bir örneklem üzerinde çalışılmıştır. Anketler, öğrencilere online ve yüz yüze olacak şekilde, QR kodlu broşürler ve doğrudan anket formları aracılığıyla uygulanmıştır. Örneklem grupları en az, %95 güven düzeyinde orantılı kotalarla belirlenen örnek büyüklüklerini sağlayacak şekilde rastgele seçim süreciyle seçilmiştir. Veri seti, söz konusu koşulları sağlamak koşuluyla, Ekonometri bölümünden 164 ve İktisat bölümünden 243 öğrenci olmak üzere toplam 407 katılımcıdan oluşmaktadır. Öğrencilerin giyim alışkanlıkları, satın alma davranışları, MT, MS, MG yaklaşımlarını anlamak için oluşturulan anket formundan elde edilen veriler SPSS ve STATA programları kullanılarak incelenmiştir.

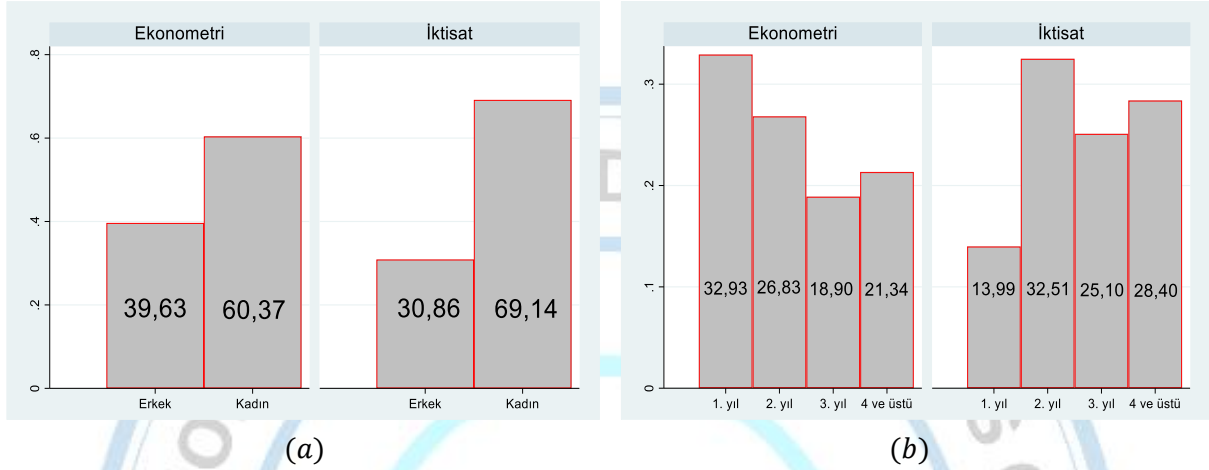
Anket formu, üç bölüm ve 28 sorudan oluşacak şekilde tasarlanmıştır. Birinci bölüm öğrencilerin sosyodemografik özellikleri, sosyal medya platformlarına ayırdıkları süreler, internet üzerinden giyim alışverişi sıklıkları ve belirli markaları takip etme nedenlerini içermektedir. İkinci bölümde, Ek-1'de verilen Tablo 1'de alışveriş yollarının önce tercih sırasına göre sıralanmaları, ardından sundukları hizmet kalitesi bakımından puanlanmaları ve öğrencilerin giyim alışverişi kriterleri bulunmaktadır. Anketin son bölümünde ise araştırmanın ölçükleri yer almaktadır. Bu bölümde ilk 7 soru MT, sonraki 4 soru MS, son 3 soru MG'ne odaklanmıştır. Bu soru grupları 5'li Likert ölçeğinde ve alan çalışmalarından yardım alınarak oluşturulmuştur. Ölçekler oluşturulurken, ilgili tabloların alt kısmında belirtilen kaynaklardan yararlanılmıştır.



### 3. BULGULAR

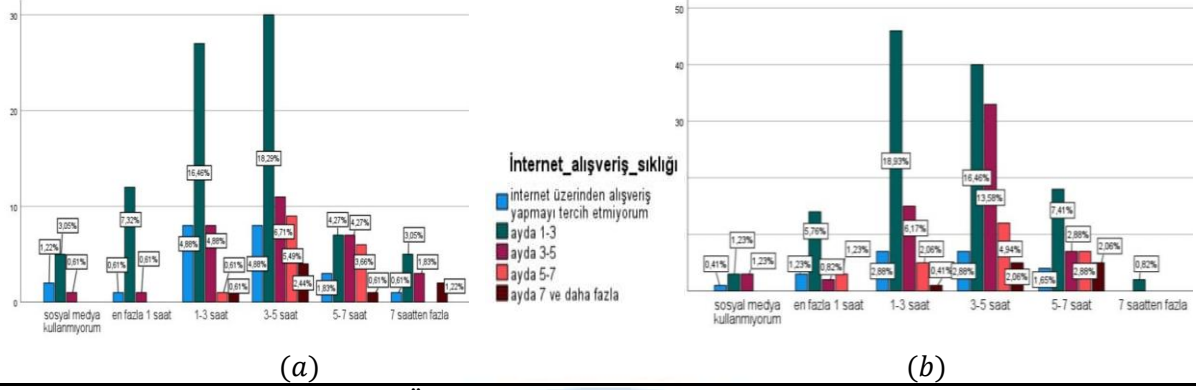
#### 3.1. Tanımlayıcı İstatistikler

Veri toplama süreci sonrasında elde edilen veriler uygun analiz ortamına aktarılmış, öncelikle oluşturulan anket sorularındaki ölçeklerin iç tutarlılıkları Cronbach'ın alfa ( $\alpha$ ) katsayısı ile kontrol edilmiştir. Bu katsayı söz konusu anket çalışması için 0.8399 olarak elde edilmiş olup; söz konusu değer, anketin kabul edilebilir iç tutarlıkta ve ölçeklerin her birinin öğrencilerin görüşlerini gereğince ölçtüğünü göstermektedir.



**Şekil 1.** (a) Katılımcıların Okudukları Bölümlere Göre Cinsiyet Dağılımı (%) ve (b) Katılımcıların Okudukları Bölümlere Göre Eğitim Yılları Dağılımı (%)

Katılımcıların genel demografik özellikleri incelendiğinde, örneklemin çoğunluğunu kadın öğrencilerin (%65,60) oluşturduğu ve erkek katılımcıların ise azınlıkta olduğu görülmektedir. Cinsiyetin bölümlere göre dağılımı ise Şekil 1(a)'da paylaşılmıştır. Öğrencilerin okudukları bölümlere ilişkin lisans eğitiminde geçirdikleri süre ise Şekil 1(b)'de paylaşılmış olup, Ekonometri bölümünde %32,93 düzeyinde bir oranla 1.sınıf, İktisat bölümünde ise %32,51 düzeyinde bir oranla 2.sınıf öğrencileri örneklemin çoğunluğunu oluşturmaktadır. Şekil 2'de öğrencilerin internet üzerinden alışveriş yapma sıklıkları bölümler üzerinden sosyal medya platformlarına ayırdıkları sürelere göre gözlemlenmektedir. Tanımlayıcı istatistikler, Ekonometri bölümü öğrencilerinin en çok 3-5 saat (%18,29) sosyal medyada vakit harcadıkları, İktisat bölümü öğrencilerinin ise 1-3 saat (%18,93) ayırdığını göstermiştir. Ekonometri bölümü öğrencilerinin çoğunun sosyal medya platformlarına 7 saatten fazla vakit ayırdığı, ancak ayda 5-7 defa internet üzerinden alışveriş yapmadığı gözlemlenmiştir. İktisat bölümü öğrencileri arasında ise, sosyal medya platformlarına 7 saatten fazla vakit ayıranların çoğunluğunun ayda 1-3 defa internet üzerinden alışveriş yaptığı belirlenmiştir. Ekonometri öğrencileri, sosyal medyada daha fazla vakit geçirseler de ürünler hakkında yapılan yorumlardan etkilenme eğilimindedir.



**Şekil 2.** (a) Ekonometri Bölümü Öğrencilerinin Sosyal Medya Platformlarına Ayırdıkları Süreler ve Alışveriş Sıklıkları (%) ve (b) İktisat bölümü Öğrencilerinin Sosyal Medya Platformlarına Ayırdıkları Süreler ve Alışveriş Sıklıkları (%)

Tablo 4 ve devamındaki frekans tablosuna göre, genel olarak ürün yorumlarının influencer'ların etkisinden daha fazla ön plana çıktığı görülmektedir. Ayrıca, kadın öğrencilerin ürün yorumlarından erkek öğrencilere göre daha fazla etkilendiği dikkat çekmektedir. Erkek öğrencilerde yorumlardan etkilenme konusunda kararsızlık ve etkileşim benzerlik gösterirken, influencer tavsiyelerinde farklılık bulunmaktadır.

**Tablo 4.** Bazı Temel Göstergelere İlişkin Frekans Tabloları (%)

**Influencer Tavsiyelerinin ve Ürün Hakkında Yapılan Yorumların Bir Ürünü Almanın Üzerindeki Etkileri**

		Kesinlikle katılmıyorum	Katılmıyorum	Kararsızım	Katılıyorum	Kesinlikle katılıyorum
Ekonometri	Yorum Etkisi	7,90	5,50	12,80	38,40	35,40
	Influencer Etkisi	23,20	16,50	19,50	25,60	15,20
İktisat	Yorum Etkisi	4,90	7,80	25,50	31,30	30,50
	Influencer Etkisi	23,00	15,20	21,00	23,00	17,70

**Ürün Hakkında Yapılan Yorumların Cinsiyete Göre Bir Ürünü Almanın Üzerindeki Etkileri**

		Kesinlikle katılmıyorum	Katılmıyorum	Kararsızım	Katılıyorum	Kesinlikle katılıyorum
Ekonometri	Erkek	17,20	11,10	26,30	26,30	19,20
	Kadın	32,30	24,60	9,20	24,60	9,20
İktisat	Erkek	15,50	16,10	22,60	25,60	20,20
	Kadın	40,00	13,30	17,30	17,30	12,00

**Influencer Tavsiyelerinin Cinsiyete Göre Bir Ürünü Almanın Üzerindeki Etkileri**

		Kesinlikle katılmıyorum	Katılmıyorum	Kararsızım	Katılıyorum	Kesinlikle katılıyorum
Ekonometri	Erkek	6,10	2,00	13,10	38,40	40,40
	Kadın	10,80	10,80	12,30	38,50	27,70
İktisat	Erkek	3,00	5,40	26,20	32,10	33,30
	Kadın	9,30	13,30	24,00	29,30	24,00

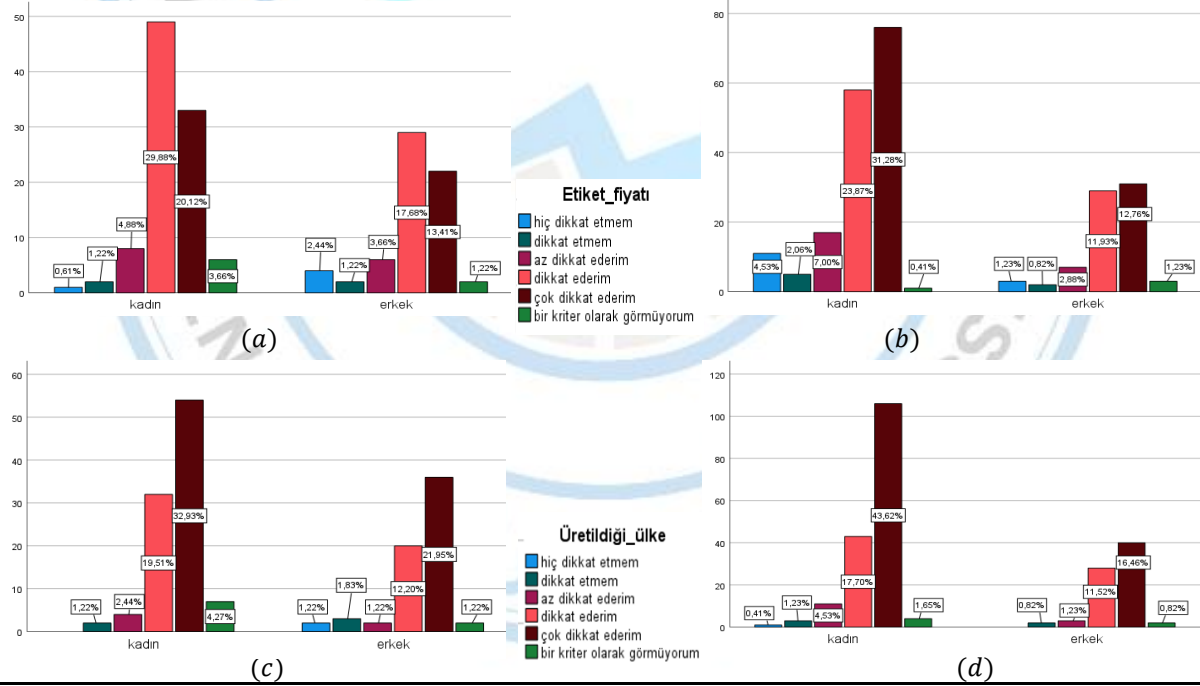
Tablo 4. devamı

Ürünün Markasının Öneminin Cinsiyete Göre Bir Ürünü Almanın Üzerindeki Etkileri						
		Kesinlikle katılmıyorum	Katılmıyorum m	Kararsız m	Katılıyorum m	Kesinlikle katılıyorum
Ekonometri	Erkek	16,90	9,20	10,80	41,50	21,50
	Kadın	4,00	9,10	25,30	35,40	26,30
İktisat	Erkek	5,30	12,00	14,70	45,30	22,70
	Kadın	12,50	6,00	16,70	31,50	33,30

Markanın Uzun Yıllar Piyasada Bulunmasının Verdiği Güvenin Cinsiyete Göre Bir Ürünü Almanın Üzerindeki Etkisi						
		Kesinlikle katılmıyorum	Katılmıyorum m	Kararsız m	Katılıyorum m	Kesinlikle katılıyorum
Ekonometri	Erkek	4,60	7,70	12,30	36,90	38,50
	Kadın	3,00	1,00	15,20	40,40	40,40
İktisat	Erkek	1,30	14,70	12,00	29,30	42,70
	Kadın	4,80	5,40	18,50	27,40	44,00

Ekonometri bölümündeki erkek öğrenciler, influencer tavsiyelerinden İktisat bölümündeki erkek öğrencilere göre daha fazla etkilenmektedir. Benzer şekilde, kadın Ekonometri öğrencileri, İktisat öğrencilerine kıyasla influencer tavsiyelerinden daha fazla etkilenmektedir. Erkek öğrencilerde markanın satın alma üzerindeki etkisi daha belirginken, kadın İktisat öğrencileri markanın etkisini daha fazla hissetmektedir. Genel anlamda ürün markasının satın alma üzerinde olumlu bir etkisi olduğu belirtilmiştir.



Şekil 3. (a) Ekonometri Bölümü Öğrencilerinin Cinsiyete Göre Ürünün Etiket Fiyatına Yaklaşımları (%), (b) İktisat Bölümü Öğrencilerinin Cinsiyete Göre Ürünün Etiket Fiyatına Yaklaşımları (%), (c) Ekonometri Bölümü Öğrencilerinin Cinsiyete Göre Ürünün Üretildiği Ülkeye Olan Yaklaşımları (%), (d) İktisat Bölümü Öğrencilerinin Cinsiyete Göre Ürünün Üretildiği Ülkeye Olan Yaklaşımları (%)

Şekil 3, İktisat ve Ekonometri bölümü öğrencilerinin cinsiyete bağlı olarak ürün tercihlerinin görsel olarak incelenmesini ortaya koymaktadır. Buna göre, İktisat öğrencilerinin, Ekonometri öğrencilerine göre markaların güven yaratmasını daha fazla önemseydiği söylenebilir. Söz konusu grafikler daha detaylı incelendiğinde, kadın Ekonometri öğrencileri (%29,88), etiket fiyatına erkeklerden (%17,68)



daha fazla dikkat ederken, etiket fiyatını kriter olarak görmeyen kadınların (%3,66) oranı da erkeklerden (%1,22) daha fazladır. *Şekil 3(a)* ve *Şekil 3(b)*, kadınların etiket fiyatına erkeklerden daha fazla dikkat ettiğini ve hiç dikkat etmeyenlerin İktisat bölümünde yoğunlaştığını göstermektedir. İktisat öğrencileri arasında, kadınlar (%31,28) ürünü üretildiği ülkeye erkeklere (%12,76) göre daha fazla dikkat etmektedir. Ekonometri öğrencilerinde ise cinsiyet farkları daha az belirgindir. Her iki bölümde de kadın öğrenciler, ürünün üretildiği ülkeye erkek öğrencilerden daha fazla dikkat etmektedir. *Şekil 3(c)* ve *Şekil 3(d)*, Ekonometri kadın öğrencilerinin ve İktisat erkek öğrencilerinin ürünün üretildiği ülkeye önem verdiğini göstermektedir.

#### 4. ARAŞTIRMANIN ODAK SORULARINA İLİŞKİN BULGULAR

Çalışmanın ileri analizlerinde öncelikle, alışveriş kriterleri ile öğrencilerin MT, MS ve MG puanları arasındaki ilişki yapıları  $\chi^2$  Bağımsızlık analizleri ile incelenmiş ve sonuçları *Tablo 5*'te sunulmuştur. *Tablo 5*'te verilen sonuçlara göre, MT'de her iki bölüm için etiket fiyatının belirleyici olmadığını, ancak Ekonometri bölümü öğrencilerinin MG yaklaşımı ile fiyatlar arasında %90 güven düzeyinde anlamlı bir etkileşim olduğunu söylenebilmektedir. Bu, Ekonometri öğrencilerinin fiyat kriterinin MT'den çok MG ile ilişkili olduğunu göstermektedir. İktisat bölümü öğrencilerinin MG yaklaşımının ise ürünün indirimde olması ile ilişkili olduğu bulgusuna ulaşılmıştır.

**Tablo 5. Kıyafet Alışverişi Kriterleri ve Tercih, Sadakat, Güveni Dikkate Alan Ölçeklerin Bağımsızlık Analizi**

		Ekonometri			İktisat		
		MT	MS	MG	MT	MS	MG
<b>Fiyat</b>	$\chi^2$	99,8866	66,593	61,1392	84,9308	49,6883	46,6747
	<i>p</i> -değeri	(0,484)	(0,388)	<b>(0,096)*</b>	(0,914)	(0,826)	(0,527)
<b>Kalite</b>	$\chi^2$	73,4880	53,7774	43,8044	158,5467	64,5595	55,1949
	<i>p</i> -değeri	(0,978)	(0,815)	(0,645)	<b>(0,045)**</b>	(0,800)	(0,652)
<b>Kullanım Süresi</b>	$\chi^2$	93,5721	81,6559	62,9248	120,4509	106,0574	65,6877
	<i>p</i> -değeri	(0,984)	(0,428)	(0,373)	(0,714)	<b>(0,011)**</b>	(0,286)
<b>Üretim Tarihi</b>	$\chi^2$	121,0242	95,503	57,9224	138,9589	69,2717	46,0481
	<i>p</i> -değeri	(0,584)	(0,114)	(0,552)	(0,279)	(0,665)	(0,908)
<b>Mevsime Uygunluk</b>	$\chi^2$	106,4189	91,2471	73,4892	132,0131	82,2305	65,4666
	<i>p</i> -değeri	(0,884)	(0,183)	(0,113)	(0,434)	(0,266)	(0,293)
<b>Materyal</b>	$\chi^2$	75,2548	100,6011	60,3738	120,6205	107,0572	58,8736
	<i>p</i> -değeri	(1,000)	<b>(0,060)*</b>	(0,462)	(0,710)	<b>(0,009)***</b>	(0,517)
<b>İndirim</b>	$\chi^2$	112,0632	75,5121	56,5178	118,5961	76,2177	75,3082
	<i>p</i> -değeri	(0,790)	(0,621)	(0,604)	(0,754)	(0,439)	<b>(0,088)*</b>
<b>Moda</b>	$\chi^2$	127,8296	73,6128	54,9456	14,6374	89,211	53,0452
	<i>p</i> -değeri	(0,413)	(0,679)	(0,660)	(0,229)	(0,126)	(0,726)
<b>Çekicilik</b>	$\chi^2$	129,5176	76,5019	51,9678	99,3423	81,9331	54,6073
	<i>p</i> -değeri	(0,373)	(0,590)	(0,760)	(0,979)	(0,273)	(0,672)
<b>Psikolojik Dürtü</b>	$\chi^2$	105,6179	104,8692	70,1721	195,2121	70,4561	50,3249
	<i>p</i> -değeri	(0,895)	<b>(0,033)**</b>	(0,173)	<b>(0,000)***</b>	(0,627)	(0,809)
<b>Ülke</b>	$\chi^2$	124,5746	87,9614	67,5622	177,2103	113,0218	59,0258
	<i>p</i> -değeri	(0,494)	(0,254)	(0,235)	<b>(0,004)***</b>	<b>(0,003)***</b>	(0,511)
<b>Bilinirlik</b>	$\chi^2$	100,4831	74,0618	66,2816	148,6655	93,7991	56,0046
	<i>p</i> -değeri	(0,948)	(0,666)	(0,269)	(0,126)	<b>(0,070)*</b>	(0,622)

\*\*\*, \*\* ve \* sırasıyla %1, %5 ve %10 seviyelerinde istatistiksel önemi ( $\alpha$ ) temsil eder. Hesaplanan *p*-değerleri parantez içinde belirtilmiştir.

Bu durum *Tablo 4*'de ürünün markasının önemini ele alan bulgular incelenirken, İktisat bölümü öğrencileri için markanın öneminin bir ürünü almanın üzerindeki gözlemlenen etkisiyle uyumludur. *Tablo 5*, İktisat bölümü öğrencileri için markanın öneminin, ürünün fiyatından daha büyük bir etkiye sahip olduğunu göstermektedir. *Tablo 5* incelenmeye devam edildiğinde, ürünün kalitesi, İktisat öğrencileri için MT ile etkileşim halinde iken, Ekonometri öğrencileri için bu etkileşim bulunmamıştır. Ürünün mevsime uygunluğu ile öğrencilerin MS'leri arasında anlamlı bir etkileşim olmamakla birlikte, İktisat öğrencilerinin MS'leri ile ürünün üretildiği ülke ve ürünün bilinirliği belirleyici kriterlerdir. Ekonometri öğrencilerinin MS'leri daha çok psikolojik dürtülerden etkilenirken, İktisat öğrencilerinin MT'leri büyük ölçüde psikolojik dürtülerden etkilenmektedir. Ürünün materyalinin her iki bölümde de MS üzerinde etkili olduğu görülmüştür. Öğrenciler, ürün satın alırken materyal içeriğini diğer kriterlerin ötesinde tutmakta, fiyatı ise daha az önemli görmektedir. Ürünün üretildiği ülke, Ekonometri öğrencilerinin her üç ölçek puanları ile anlamlı bir etkileşim göstermezken, İktisat öğrencilerinin MT ve MS puanları ile anlamlı bir etkileşim sergilemektedir. Bu durum, *Şekil 3(c)* ve *Şekil 3(d)* ile uyumludur. Son olarak, markanın bilinirliği, İktisat öğrencilerinin MS'leri ile anlamlı bir etkileşim gösterirken, Ekonometri öğrencilerinde bu etkileşim görülmemiştir.

Çalışmanın sonraki kısmında literatüre dayalı olarak oluşturulan ortalama MT, MS ve MG ölçeklerinin öğrencilerin okudukları bölümler arasındaki benzerlik ve farklılıkları gözlemlemek amacıyla hipotezler oluşturulmuş ve incelenmiştir. Bu hipotezler, *t*-testine tabi tutulan ortalamaların anlamlı bir farklılık içerip içermediğini test etmek üzere değerlendirilmiştir ve İki Örneklem *t*-Testi, değişkenler arasında istatistiksel olarak anlamlı bir farklılık olup olmadığını belirlemek için kullanılmıştır<sup>1</sup>.

- i.  $H_0: \mu_{MT_{Ekonometri}} - \mu_{MT_{İktisat}} = 0$
- ii.  $H_0: \mu_{MS_{Ekonometri}} - \mu_{MS_{İktisat}} = 0$
- iii.  $H_0: \mu_{MG_{Ekonometri}} - \mu_{MG_{İktisat}} = 0$

**Tablo 6. Ortalama Marka Algısı Puanı *t* Tablosu**

	$\bar{x}$	<i>t</i>	<i>p</i> -değeri	$H_0$
<b>MT</b>				
<b>Ekonometri</b>	3,409,408	0,1044	(0,9169)	Reddedilemedi.
<b>İktisat</b>	3,400,941			
<b>MS</b>				
<b>Ekonometri</b>	3,315,549	-21,068	<b>(0,0357)**</b>	Reddedildi.
<b>İktisat</b>	3,531,893			
<b>MG</b>				
<b>Ekonometri</b>	3,703,252	-0,4255	(0,6707)	Reddedilemedi.
<b>İktisat</b>	3,746,228			

\*\*\*, \*\* ve \* sırasıyla %1, %5 ve %10 seviyelerinde istatistiksel önemi ( $\alpha$ ) temsil eder. Hesaplanan *p*-değerleri parantez içinde belirtilmiştir.

*Tablo 6*'da söz konusu istatistiksel testlerin sonuçları verilmiştir. Bu tabloda yer alan sonuçlara göre, ortalama marka algısı puanı birinci ve üçüncü hipotezler için reddedilemezken, ikinci hipotez için reddedilmiştir. Buna göre iki bölümün ortalama puanlarını incelendiğinde, özellikle MS ölçeğinde Ekonometri ve İktisat öğrencilerinin ortalama puanlarının anlamlı bir şekilde farklı olduğu, ancak MT ve MG ölçeklerinde aynı farklılığın gözlemlenmediği %95 güven düzeyinde tespit edilmiştir. Öğrencilerin ortalama marka algısı puanları, *Tablo 5*'deki bağımsızlık analizleri ve *Tablo 6*'daki *t*-testleri sonuçları ile uyumlu bulunmuştur.

<sup>1</sup> Bu aşamada oluşturulan ölçeklerin Normal dağılıma uygunluğu tespit edilmiştir.

Tablo 7, MT, MS ve MG ölçekleri arasındaki doğrusal ilişkinin bölümler arası karşılaştırmasını sunmaktadır. Pearson korelasyon katsayısından yararlanılarak ölçülen değerler incelendiğinde ölçeklerin birbirleriyle pozitif yönde ve orta düzeyin üstünde denebilecek bir ilişki içinde olduğunu ve bu ilişkilerin istatistiksel olarak anlamlı olduğunu göstermektedir. Literatürde bu ölçekler arasındaki ilişkinin varlığı yaygın olarak bilindiğinden Tablo 7 bu ilişkiyi desteklemektedir. Bu ilişkiler bölümler üzerinden incelendiğinde, Ekonometri bölümü öğrencileri için MT ile MS ve MG arasındaki ilişkiler daha güçlü bir ilişki yapısı sergilerken, İktisat bölümü öğrencilerinde bu durum MS ile MG arasında ortaya çıkmaktadır. Bu durum, ele alınan kavramların farklı bölümlerde okuyan öğrenciler bakımından farklı algılandıkları şeklinde yorumlanabilir.

**Tablo 7: Tercih, Sadakat ve Güveni Dikkate Alan Ölçeklerin Pearson Korelasyon Matrisi**

	Ekonometri			İktisat		
	MT	MS	MG	MT	MS	MG
MT	1			1		
MS	0.7317	1		0.686	1	
<i>p</i> -değeri	(0.0000)***			(0.0000)***		
MG	0.7221	0.684	1	0.6804	0.7665	1
<i>p</i> -değeri	(0.0000)***	(0.0000)***		(0.0000)***	(0.0000)***	

\*\*\*, \*\* ve \* sırasıyla %1, %5 ve %10 seviyelerinde istatistiksel önemi ( $\alpha$ ) temsil eder. Hesaplanan *p*-değerleri parantez içinde belirtilmiştir.

## 5. TARTIŞMA VE ÖNERİLER

Bu araştırmada, Ankara Hacı Bayram Veli Üniversitesi'nde 2023-2024 bahar döneminde eğitim gören İktisat ve Ekonometri bölümü lisans öğrencilerinin marka tercihini etkileyen faktörler üzerine Marka Tercihi (MT), Marka Sadakati (MS) ve Marka Güveni (MG) yaklaşımları incelenmiştir. Çalışma, öğrencilerin giyim alışverişi kriterlerini ve bu kriterlerin ölçekler bazındaki etkileşimlerini analiz ederek benzerlikler ve farklılıkları ortaya koymayı amaçlamıştır. Araştırma, 407 kişilik bir örnekleme gerçekleştirilmiş olup, katılımcıların çoğunluğunu kadınlar oluşturmaktadır ve %50,61'ini 19-21 yaş aralığındaki öğrenciler oluşturmaktadır.

Araştırma bulgularına göre, güvenilen markaların yüksek fiyatlarına rağmen, bu fiyatların kabul edilme eğilimi yüksektir. Özellikle, sadakat düzeyi yüksek olan markaların tercih edilmesinde fiyat algısının daha az etkili olduğu görülmektedir. Bu bulgu, Aaker (1996)'ın marka sadakati ve marka güveni üzerine yaptığı çalışmalarla uyumludur. Kadınların sosyal medya platformlarını daha fazla kullanmaları nedeniyle bu tür etkilenmelere daha açık oldukları, daha detaylı araştırmalarla incelenebilir. Öğrencilerin kendi gelirlerini henüz kazanmamaları, marka tercihlerini finansal kısıtlamalar nedeniyle gerçekleştirememeleri ile ilişkilendirilebilir. Öğrencilerin bir markayı arzulamalarına karşın finansal özgürlüklerinin olmaması, tercihlerin gerçekleşmemesine neden olabilmektedir. Sosyal medya kullanımının alışveriş alışkanlıkları üzerindeki etkileri de dikkat çekicidir. Bu platformlarda geçirilen sürenin artması, influencer tavsiyeleri ve ürün yorumlarının alışveriş kararları üzerinde önemli bir rol oynadığı görülmektedir. Bu etkilerin kadın öğrenciler arasında daha belirgin olması, sosyal medya kullanımının cinsiyet bazında farklılıklar yarattığını göstermektedir. Bu bulgu, Bozkurt (2021:567-579) ve Godey vd. (2016:5833-5841)'nin sosyal medyanın tüketici davranışları üzerindeki etkilerini inceleyen çalışmalarıyla uyumludur. Uzun yıllar piyasada bulunan ürünlerin güven yarattığını düşünen öğrenciler, aynı zamanda ürünün markasına da dikkat etmektedir.

Markaların, sadakat düzeyi yüksek olan müşteriler için özel stratejiler geliştirmeleri, fiyat algısının ön plana çıkmadığı bu gruba yönelik kampanyalar düzenlemeleri önerilmektedir. Bu stratejiler, Aaker (1996) ve Oliver (2010)'ın marka sadakati üzerine çalışmalarında vurguladıkları gibi duygusal bağ kurmaya yönelik olmalıdır. Bu bağlamda özellikle sosyal medya platformları ve influencer'lar üzerinden



yürütülen pazarlama stratejilerinin, özellikle kadın tüketiciler üzerinde etkili olduğu bu çalışmada gözlenmiştir. Dolayısıyla Seock ve Norton (2007:571-586)'ın bulgularına da paralel olarak, sosyal medyada geçirilen süre ve etkileşimlerin satın alma kararlarını nasıl etkilediğine dair daha detaylı araştırmalar yapılabilir. Öte yandan söz konusu araştırmaya konu olan öğrencilerin büyük çoğunluğunun finansal bağımsızlıkları olmadığı için, markalar uygun fiyatlı ürünler ve öğrenciye özel kampanyalar düzenleyebilirler. Pazarlama stratejileri bakımından burada derlenen cinsiyet bazındaki faktörler incelendiğinde ise kadın tüketiciler için sosyal medya ve influencer'ların daha etkin kullanımı, erkek tüketiciler için ise güvenilir ve bilinirliği yüksek markaların ön planda tutulması önerilebilir.

Çalışma her ne kadar Türkiye'nin başkentinde ve merkezi konuma sahip bir devlet üniversitesinde uygulansa da farklı illerde yer alan öğrencilerin de dikkate alındığı büyük ölçekli bir çalışmanın üniversite öğrencilerinin genel yaklaşımlarının anlaşılması için gelecek çalışmaların planlanması bakımından düşünülebilir.

### **Teşekkür**

Bu araştırma, merhum Alev Alatlı anısına 21 Mayıs 2024'te UYIK tarafından İstanbul Marmara Üniversitesi ev sahipliğinde gerçekleştirilen Uluslararası Kongre'de yüz yüze sunulmuştur. Araştırma halihazırda devam eden TÜBİTAK 2209-A Üniversite Öğrencileri Destekleme Projesi kapsamında da desteklenmektedir. Araştırmaya yol gösteren danışman hocamız Sayın Doç. Dr. Şahika Gökmen'e ve araştırma süresince katkılarından dolayı Sezin Yılmaz'a teşekkür ederiz. İlgili kurum, kuruluş ve üniversitelere destekleri için minnettarız.

### **REFERANSLAR**

- Ahmed, M. E., Samad, N., & Khan, A. G. (2021). Factors influencing online purchase intention: a case of University students in Pakistan. *Eurasian Journal of Social Sciences*, 9(1), 31-43.
- Alimen, N., & Guldem Cerit, A. (2010). Dimensions of brand knowledge: Turkish university students' consumption of international fashion brands. *Journal of Enterprise Information Management*, 23(4), 538-558.
- Anafi, O. I. (2021). Impact of Electronic Marketing Strategies on Consumer Buying Behaviour Among Kwara State Polytechnic Students, Ilorin. Kwara State University (Nigeria).
- Aaker, D. A. (1996). *Managing Brand Equity*. The Free Press, a division of Simon & Schuster Inc. 42-51-408.
- Bozkurt, G. Ş. (2021). Pazarlamanın yeni silahı sosyal medya fenomenleri: fenomen pazarlamanın marka algısına etkisinin değerlendirilmesi. 25. Pazarlama Kongresi, 567-579.
- Çakır, İ., & Dedeoğlu, A. Ö. (2020). İkinci El Giyim Sitelerinde Algılanan Risklerin Satın Alma Niyeti Üzerine Etkisi.
- Durmuş, İ., & Battal, F. (2018). Üniversite Öğrencilerinin Hazır Giyim Satın Alma Kararlarında Reklamlara Yönelik Tutumları ve Marka Tercihleri. *Gümüşhane Üniversitesi Sosyal Bilimler Enstitüsü Elektronik Dergisi*, 9(24).
- Ebrahim, R. S. (2013). A study of brand preference: an experiential view (Doctoral dissertation, Brunel University Brunel Business School PhD Theses).
- Elena, D. B., & Jose, L. M. A. (2001). Brand trust in the context of consumer loyalty. *European journal of Marketing*, 35(11-12), 1238-1258.
- Elena, D. B., E., & Hernández-Espallardo, M. (2008). Effect of brand associations on consumer reactions to unknown on-line brands. *International Journal of Electronic Commerce*, 12(3), 81-113.
- Guest, L. (1944). A study of brand loyalty. *Journal of Applied Psychology*, 28(1), 16.
- Godey, B., Manthiou, A., Pederzoli, D., Rokka, J., Aiello, G., Donvito, R., & Singh, R. (2016). Social media marketing efforts of luxury brands: Influence on brand equity and consumer behavior. *Journal of business research*, 69(12), 5833-5841.
- Halaweh, J., Al-Haddad, S., Al-Khasawneh, M., Sharabati, A., Haddad, H., (2023). The effect of Instagram on millennials consumer's purchase intentions in the fashion industry. *International Journal of Data and Network Science*, 7(4), 1885-1900.

- Kıran, Ö. (2021). Türkiye’de sosyal medya konulu doktora tezlerinin incelenmesi. Afyon Kocatepe Üniversitesi Sosyal Bilimler Dergisi, 23(3), 1066-1085.
- Keller, K. L. (1956). Strategic Brand Management: Building, Measuring, and Managing Brand Equity (4th ed.). San Francisco, CA: Pearson: FIDM Library.
- Kahraman, M. A., & Dağlı, S. (2019). Marka Algısı, Müşteri Memnuniyeti ve Marka Tercih İlişkisinin X ve Y Kuşağına Göre İncelenmesi. Uluslararası Ekonomi İşletme ve Politika Dergisi, 3(2), 381-398.
- Mayasari, I., Haryanto, H. C., Hutagaol, O. D., Ramadhan, A. R., & Amir, I. (2023). Examining the Role of Social Media Marketing on Brand Love and Its Impact on Brand Centrality: The Study of Local Fashion Brands for the Millennials. Journal of Indonesian Economy and Business, 38(2), 147-165.
- McClure, C. S. (2017). Fashion boutiques and social media: a uses and gratification approach to convergent analysis from small business and customer perspectives (Doctoral dissertation, University of Georgia).
- Muniady, R., Al-Mamun, A., Permarupan, P. Y., & Zainol, N. R. B. (2014). Factors influencing consumer behavior: A study among university students in Malaysia. Asian Social Science, 10(9), 18.
- Nistor, L. (2019). Young consumers’ fashion brand preferences. An investigation among students in Romania. Acta Universitatis Sapientiae, Communicatio, (6), 41-59.
- Oliver, R. L. (2010). Consumer brand loyalty. Wiley International Encyclopedia of Marketing.
- Romano, D. M. (2003). The nature of trust: conceptual and operational clarification. Louisiana State University and Agricultural & Mechanical College.
- T.C. Sanayi ve Teknoloji Bakanlığı. (2021). Kaynak: <https://www.sanayi.gov.tr/plan-program-raporlar-ve-yayinlar/sektor-raporlari>.
- T.C. Sanayi ve Teknoloji Bakanlığı. (2023). Kaynak: <https://www.sanayi.gov.tr/plan-program-raporlar-ve-yayinlar/faaliyet-raporlari>
- Sarkar, J. G., Sarkar, A., & Ponnampalnam, A. (2015). Exploration of brand sacralization among the young adult consumers in the context of emerging Asian market. Young Consumers.
- Seock, Y. K., & Norton, M. (2007). Attitude toward internet web sites, online information search, and channel choices for purchasing. Journal of fashion marketing and management: an international journal, 11(4), 571-586.
- Stern, B. B. (2006). What does brand mean? Historical-analysis method and construct definition. Journal of the academy of marketing science, 34(2), 216-223.
- Sharp, B. (2017). Marketing: Theory, Evidence, Practice (2nd edition). Oxford University Press. 76-389.
- Şekerkeya, A., & Cengiz, E. (2010). Kadın Tüketicilerin Alışveriş Merkezi Tercihlerinin Belirlenmesi ve Bir Pilot Araştırma. Öneri Dergisi, 9(34), 41-55.
- Yayla, A. G. A., Tektaş, N., Ceviz, Ö. G. N. Ö., Sarıkış, A. G. A., Polat, A. G. Z., & Tektaş, M. (2018). Önlisans Öğrencilerinin Sosyo-Demografik-Ekonomik Statülerinin Alışveriş Davranış Biçimlerine Etkileri.

## EKLER

### Ek-1

İsim	Etiket	Değer
Sosyal medya butikleri	<b>q11a, q12a</b>	tercih1, puan1
Mağaza& AVM	<b>q11b, q12b</b>	tercih2, puan2
Butik Mağazalar	<b>q11c, q12c</b>	tercih3, puan3
Online Alışveriş	<b>q11d, q12d</b>	tercih4, puan4
İkinci el ürün mağazaları	<b>q11e, q12e</b>	tercih5, puan5
Etiket fiyatı	<b>q13Fiyat</b>	faktor1
Ürünün kalitesi	<b>q13Kalite</b>	faktor2
Kullanım süresi	<b>q13Kullanımsür</b>	faktor3
Üretim tarihi	<b>esi</b>	faktor4
Mevsime uygunluk	<b>q13Uretimtarihi</b>	faktor4
Ürünün içerdiği materyal	<b>q13Mevsimeuyg</b>	faktor5
Ürünün indirimde olması	<b>unluk</b>	faktor5
Modayı takip etmesi	<b>q13Urunmatery</b>	faktor6
Tasarım ve estetiklik	<b>ali</b>	faktor6
Psikolojik dürtüler	<b>q13Indirim</b>	faktor7
Üretildiği ülke	<b>q13Moda</b>	faktor8
Bilinirlik	<b>q13Gorselcekicil</b>	faktor9
	<b>ik</b>	faktor9
	<b>q13Psikolojikdu</b>	faktor10
	<b>rtu</b>	faktor10
	<b>q13Ulke</b>	faktor11
	<b>q13Bilinirlik</b>	faktor12

Etiket	Ölçek	Soru
<b>q14.1.1</b>	Marka Tercihi	Kullandığım ürünlerin markaları benim için önemlidir.
<b>q14.2.1</b>	(MT)	Farklı markaların ürünlerini araştırırım.
<b>q14.3.1</b>		Kıyafet alırken markasının ne olduğuna dikkat etmem.
<b>q14.4.1</b>		Marka tercihimde okuduğum yorumların etkisi olur.
<b>q14.5.1</b>		Marka tercihimde influencer'ların etkisi olur.
<b>q14.6.1</b>		Marka tercihimde sosyal çevrem yapmış yorumların etkisi olur.
<b>q14.7.1</b>		Kıyafet alırken markanın popülerliğine dikkat ederim.
<b>q14.8.2</b>	Marka Sadakati	Popüler markalı kıyafetler giyince kendimi iyi hissedirim.
<b>q14.9.2</b>	(MS)	Popüler markalı kıyafetler prestij bir göstergesidir.
<b>q14.10.2</b>		Kıyafetlerimi her zaman tercih ettiğim markalardan almaya özen gösteririm.
<b>q14.11.2</b>		Farklı markanın ürünü ilgimi çekerse düzenli olarak kullandığım markadan vazgeçebilirim.
<b>q14.12.3</b>	Marka Güveni	Çoğu insan tarafından tercih edilen marka bende satın alma isteği uyandırır.
<b>q14.13.3</b>	(MG)	Markanın yarattığı kalite benim için önemlidir.
<b>q14.14.3</b>		Uzun yıllar piyasada bulunan markalar güven hissi verir.

**Kaynak:** Şekerkeya& Cengiz, 2010:41-55; McClure, 2017; Çakır& Dedeoğlu, 2020; Kıran, 2021: 1066-1085; Halaweh, vd., 2023:1885-1990.



## İnsani Gelişme ve Ekonomik Büyüme: Gelişmekte Olan Ülkeler İçin Ampirik Bir Analiz

Kurtuluş Bozkurt<sup>1</sup>, Aytaç Pekmezci<sup>2</sup>, Özge Taş<sup>3\*</sup>

<sup>1</sup>Aydın Adnan Menderes Üniversitesi, Söke İşletme Fakültesi, Ekonomi Bölümü,09200, Aydın, Türkiye

<sup>2</sup>Muğla Sıtkı Koçman Üniversitesi, Fen Fakültesi, İstatistik Bölümü,48000,Muğla,Türkiye

<sup>3</sup>Kapadokya Üniversitesi, Kapadokya Meslek Yüksek Okulu, Bilgisayar Teknolojileri Bölümü, Bilgisayar Programcılığı Pr, 50400, Nevşehir, Türkiye

\*Sorumlu yazar e-mail: ozge.tas@kapadokya.edu.tr

### Özet

Ülkelerin bir arada iktisadi, kültürel, sosyal ve politik anlamda ilerleme sürecinde olması gelişmenin göstergesi olarak kabul edilmektedir. Bu yüzden gelişmenin merkezinde yer alan insanın yaşam kalitesini belirlemek için literatürde genel geçerliliği olan eğitim, sağlık ve gelir göstergelerinin bir araya gelmesiyle insani gelişme endeksi elde edilir. Ekonomik büyüme için önemli bir girdi kabul edilen bu endeks yardımıyla ülkelerin birbirleri ile gelişme seviyeleri karşılaştırılır ve bilimsel açıdan tarafsız bilgiler elde edilir. Buradan yola çıkarak çalışmanın amacı, 1990-2021 zaman aralığında dünya bankası veri tabanlarından temin edilen 32 gelişmekte olan ülke için insani gelişme ile ekonomik büyüme arasındaki uzun ve kısa dönemli ilişkiyi panel veri analiz yöntemini kullanarak incelenmiştir. Yapılan analizler sonucunda ise incelenen değişkenler arasında uzun dönemde bir eşbütünleşme ilişkisinin olduğu ve kısa dönemde nedensellik analizi ile çift taraflı bir ilişki olduğu tespit edilmiştir.

**Anahtar Kelimeler:** İnsani Gelişme, Ekonomik Büyüme, Panel Veri Analizi

### GİRİŞ

İktisat literatüründe kalkınmanın nihai hedefi olarak değerlendirilen insani gelişme kavramı, ekonomi politikalarının ve politika yapıcılarının başarılarını da gösteren önemli bir kavramdır. Zira tüm iktisadi faaliyetlerin ve iktisat politikalarının temelinde insani gelişimini tamamlayan, gelir seviyesi ve refah düzeyi yüksek bir toplum inşa etme ideali yatmaktadır. Özellikle refah iktisadi alanında çalışan araştırmacılar, ekonomik büyüme kavramının yetersizliğine de vurgu yaparak kalkınma sürecinin nihai hedefi olarak gördükleri insani gelişme kavramına büyük önem atfederek, ekonomik büyüme ile insani gelişme arasındaki ilişkiyi incelemişlerdir. Özellikle küreselleşme süreci ile birlikte neo-liberal politikaların gelişmekte olan ülke ekonomileri üzerinde yaratmış olduğu gelir ve refah kayıpları insani gelişmişlik düzeyi üzerinde de olumsuz etkiler yaratmıştır.

Diğer taraftan ekonomik büyümenin doğrudan olmasa da dolaylı olarak insani gelişmeyi olumlu etkileyeceği, buna karşın insani gelişmişliğin ise doğrudan ekonomik büyüme üzerinde olumlu bir etkisinin olacağını söylemek yanlış olmayacaktır. Bu noktada özellikle ekonomik büyümenin ülke zenginliğini artırırken adil bir gelir dağılımını garanti altına alma imkanını sağlamayacağı yaklaşımı ile gelişmekte olan ülkeler için ekonomik büyümeden insani gelişmeye doğru bir etkileşimin sınırlı olabileceğini söylemek daha doğru bir yaklaşım tarzı olacaktır.

Çalışmada ise insani gelişmişliğin göstergesi olarak Dünya Bankası tarafında hesaplanan İnsani Gelişme İndeksi kullanılmıştır. İnsani gelişme endeksi ise beklenen yaşam süresi, öğrenim görülen ortalama yıl sayısı, kişi başına düşen gelir vb. gibi göstergeler ile hesaplanan bileşik bir indekstir ve insan kaynaklarının gelişimini ölçmektedir (Bozkurt & Yanardağ, 2020). Bu noktada söz konusu endekse göre ülkeler yüksek ve orta-düşük insani gelişmeye sahip ülkeler olarak iki farklı kategoriye

ayrılmaktadır. Diğer taraftan insan faktörü bir ülkenin ve ekonominin en önemli zenginliğidir ve bu noktada insani gelişme, insanların sağlıklı ve verimli olarak uzun bir yaşam sağlayabileceği koşulları sağlamayı amaçlamaktadır. Bu noktada yaşam kalitesinin iyileştirilmesi; eğitim, ifade özgürlüğü, kültürel ve manevi zenginlik, konut kalitesi gibi unsurların da iyileştirilmesi ve bunun için altyapının düzenlenmesini kapsamaktadır (Bozkurt & Yanardağ, 2020). Ayrıca sürdürülebilir kalkınma ve büyüme hedefleri kapsamında insani gelişmede son derece büyük önem arz etmektedir.

Bu bağlamda ekonomik büyüme ve insani gelişme arasındaki kısa ve uzun dönemli ilişkilerin incelenmesi son derece önem arz etmektedir. Bu çalışmada ise tamda bu kapsamda gelişmekte olan ülkeler için her iki değişken arasındaki kısa ve uzun dönemli ilişkiler panel veri analiz yöntemi ile incelenmiş, iki değişken arasında çift taraflı bir nedensellik ilişkisinin olup olmadığı test edilmiştir.

Yukarıda da ifade edildiği üzere iktisat literatüründe, insani gelişme endeksi ve ekonomik büyüme arasındaki ilişki araştırmacıların üzerinde durduğu önemli çalışma alanlarından birini oluşturmaktadır. Literatüre bakıldığında konuyla ilgili çok sayıda çalışmanın yapıldığı görülmektedir. Bu çalışmada; söz konusu çalışmalardan, ekonometrik analiz yöntemlerini kullanarak iki değişken arasındaki ilişkiyi analiz etmeye çalışan çalışmaların bazıları aşağıda kısaca özetlenmiştir.

**Tablo 1.** Değişkenlerle İlgili Yapılan Akademik Çalışmalar

Yazar/lar	Örneklem / Dönem	Değişkenler	Yöntem	Sonuç	
Birdsall (1995)	Doğu Asya Ülkeleri / 1980 - 1990	GSYİH ve İGE	Panel Analizi	Veri	Değişkenler arasında uzun dönemli ilişki ve İGE'nin GSYİH üzerinde tek yönlü pozitif etki yarattığı tespit edilmiştir.
Ramirez (1997)	Gelişmekte olan Ülkeler / 1970 - 1992	GSYİH ve İGE	EKK		Değişkenler arasında önemli bir ilişki olduğu tespit edilmiştir.
Ramirez (1998)	Gelişmekte olan Ülkeler / 1960 - 1992	GSYİH ve İGE	Panel Analizi	Veri	Değişkenler arasında uzun dönemli ve çift yönlü nedensellik ilişkisi tespit edilmiştir.
Dufflo (2001)	Endonezya / 1974 - 1978	GSYİH ve İGE	Panel Analizi	Veri	Değişkenler arasında uzun dönemli ilişki ve GSYİH'nın İGE üzerinde tek yönlü pozitif etki yarattığı tespit edilmiştir.
Rannis Stewart (2002)	Latin Amerika Ülkeleri / 1960 - 2000	GSYİH ve İGE	EKK		Değişkenler arasında pozitif anlamlı bir ilişki tespit edilmiştir.
Case Deaton (2003)	Gelişmiş ve Gelişmekte olan Ülkeler / 1986 - 2001	GSYİH ve İGE	Panel Analizi	Veri	Değişkenler arasında uzun dönemli ve çift yönlü nedensellik ilişkisi tespit edilmiştir.
Hurt (2004)	Bangladeş / 1982 - 1998	GSYİH ve İGE	Panel Analizi	Veri	Değişkenler arasında uzun dönemli ve çift yönlü nedensellik ilişkisi tespit edilmiştir.
Ranis (2004)	Gelişmiş ve Gelişmekte olan Ülkeler / 1960 - 1990	GSYİH ve İGE	Panel Analizi	Veri	Değişkenler arasında uzun dönemli ilişki ve GSYİH'nın İGE üzerinde tek yönlü pozitif etki yarattığı tespit edilmiştir.
Suri (2011)	Gelişmekte olan Ülkeler / 1960 - 2001	GSYİH ve İGE	EKK		Değişkenler arasında pozitif anlamlı bir ilişki tespit edilmiştir.
Abraham and Ahmed (2011)	Nijerya / 1975 - 2008	GSYİH ve İGE	Hata Düzeltme Modeli		Değişkenler arasında uzun dönemli ilişki ve GSYİH'nın İGE üzerinde tek yönlü negatif etki yarattığı tespit edilmiştir.

**V. International Applied Statistics Congress (UYİK - 2024)**  
**Istanbul / Turkey, May 21-23, 2024**

Shahbaz vd. (2011)	Asya Ülkeleri / 1971 - 2000	GSYİH ve İGE	Panel Analizi	Veri	Değişkenler arasında uzun dönemli ilişki ve İGE'nin GSYİH üzerinde tek yönlü pozitif etki yarattığı tespit edilmiştir.
Marmot (2012)	Gelişmiş ve Gelişmekte olan Ülkeler / 1970 - 2005	GSYİH ve İGE	Panel Analizi	Veri	Değişkenler arasında uzun dönemli ilişki ve GSYİH'nin İGE üzerinde tek yönlü pozitif etki yarattığı tespit edilmiştir.
Grubaugh (2015)	Gelişmekte olan Ülkeler / 1980 - 2010	GSYİH ve İGE	Panel Analizi	Veri	Değişkenler arasında pozitif anlamlı bir ilişki tespit edilmiştir.
Güney (2017)	OECD Ülkeleri / 1990 - 2014	GSYİH ve İGE	EKK		Değişkenler arasında pozitif anlamlı bir ilişki tespit edilmiştir.
Uçan ve Koçak (2018)	Türkiye, İtalya, ABD, Almanya, Norveç / 1990 - 2015	GSYİH ve İGE	Pedroni Eşbütünleşme		Değişkenler arasında uzun dönemli bir ilişki tespit edilmiştir.
Bhowmik (2018)	Hindistan / 1990 - 2016	GSYİH ve İGE	Johansen Eşbütünleşme, Granger Nedensellik		Değişkenler arasında uzun dönemli ilişki ve İGE'nin GSYİH üzerinde tek yönlü pozitif etki yarattığı tespit edilmiştir.
Appiah vd. (2019)	Afrika Ülkeleri / 1990 - 2015	GSYİH ve İGE	Panel Analizi	Veri	Değişkenler arasında uzun dönemli ilişki ve GSYİH'nin İGE üzerinde tek yönlü pozitif etki yarattığı tespit edilmiştir.
Balcı Özcan (2019)	İslam İşbirliği Teşkilatı Ülkeleri / 2005 - 2017	GSYİH ve İGE	Pedroni Eşbütünleşme, Granger Nedensellik		Değişkenler arasında uzun dönemli bir ilişki tespit edilmiştir.
Erdem ve Çelik (2019)	Afrika Ülkeleri / 1995 - 2015	GSYİH, Eğitim, Sağlık, İGE	ARDL		İGE ile GSYİH arasında negatif, İGE ile eğitim ve İGE ile sağlık arasında pozitif anlamlı ilişkiler tespit edilmiştir.
Aydın (2019)	Türkiye / 1990 - 2017	GSYİH ve İGE	ARDL, Hatemi Nedensellik		Değişkenler arasında uzun dönemli ve çift yönlü nedensellik ilişkisi tespit edilmiştir.
Bozkurt Yanardağ (2020)	OECD Ülkeleri / 1990-2018	GSYİH ve İGE	Panel Eşbütünleşme ve Panel Nedensellik		Değişkenler arasında uzun dönemli ve kısa dönemlide çift taraflı bir nedensellik ilişkisi tespit edilmiştir.
Öztürk ve Suluk (2020)	Norveç / 1990 - 2017	GSYİH ve İGE	Granger Nedensellik		İGE'nin GSYİH üzerinde tek yönlü nedensellik ilişkisi tespit edilmiştir.

### METERYAL VE METOD

Araştırmanın uygulama bölümünde analiz edilen seriler Dünya Bankası istatistiki veri tabanlarından temin edilmiştir. Bu bağlamda veri temin edilebilen 32 adet orta üst gelir grubunda yer alan gelişmekte olan ülke kapsamında bir panel veri seti oluşturulmuştur. Çalışmanın analiz dönemi ise 1990-2021 dönemi olarak belirlenmiştir. Çalışmada analiz edilen 32 adet orta üst gelir grubunda yer alan gelişmekte olan ülke ise Şekil 1 ve 2'de ifade edildiği gibidir. Analizlerde serilerin logaritmik formları kullanılmıştır. Tablo 2'de söz konusu değişkenlere ilişkin açıklamalar verilmiştir.

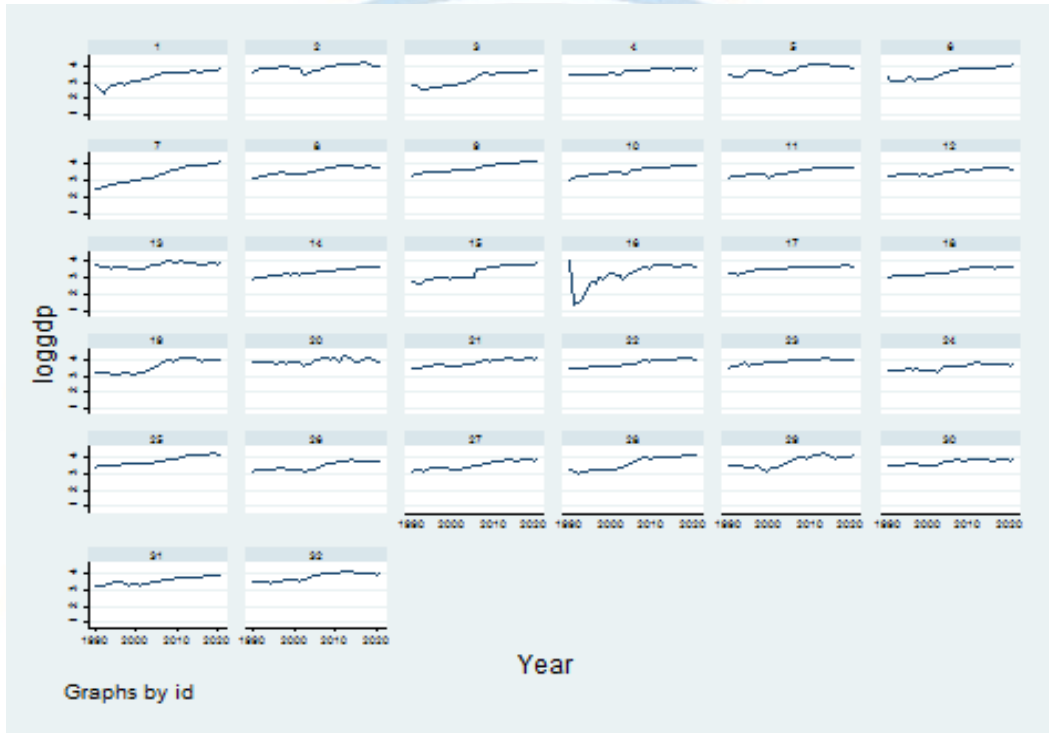


**Tablo 2.** Değişkenlere İlişkin Tanımlamalar

Kategori	Değişkenler	Kısaltma	Kaynak
Ekonomik Büyüme	Kişi Başına GSYİH	gdp	Dünya Bankası
İnsani Gelişme	İnsani Gelişme Endeksi	hdi	Dünya Bankası

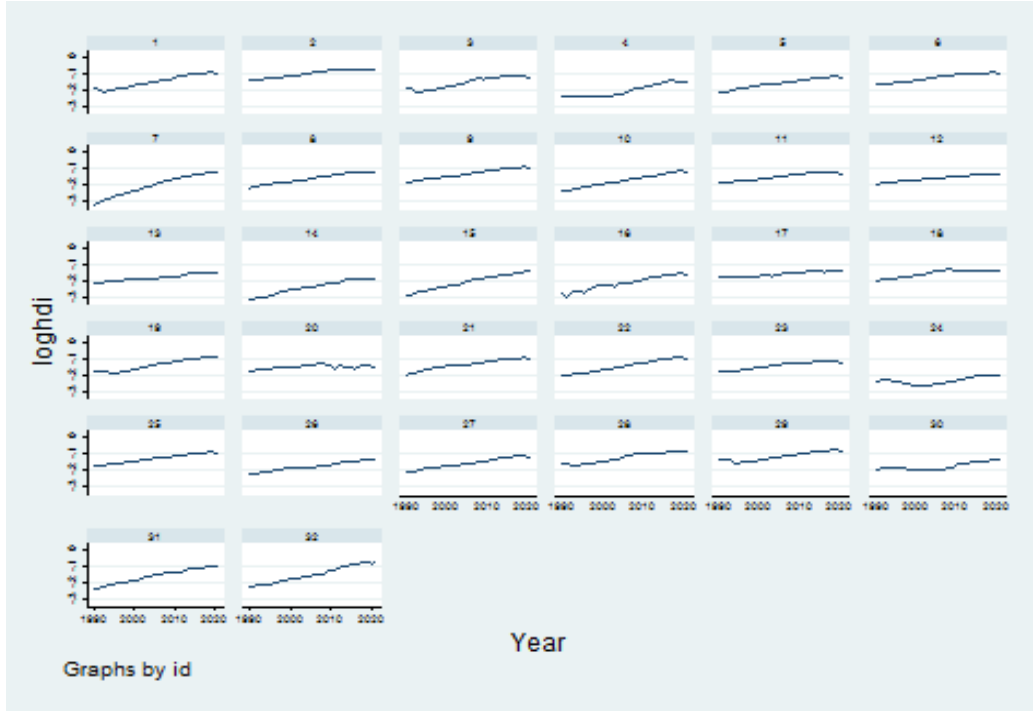
İnsani gelişmenin ekonomik büyüme ile ilişkisini analiz etmeyi amaçlayan bu çalışmada, araştırma kapsamına alınan 32 ülke için panel eşbütünleşme ve panel nedensellik testleri yapılmış ve iki değişken arasındaki kısa ve uzun dönemli ilişkiler incelenmiştir.

**Şekil 1.** Kişi Başına GSYİH (gdp) Serisine Ait Grafikler (1990-2021)



**Not:** 1; Arnavutluk, 2; Arjantin, 3; Ermenistan, 4; Botswana, 5; Brezilya, 6; Bulgaristan, 7; Çin, 8; Kolombiya, 9; Kosta Rika, 10; Dominik Cumhuriyeti, 11; Ekvador, 12; Fiji, 13; Gabon, 14; Guatemala, 15; Guyana, 16; Irak, 17; Jamaika, 18; Ürdün, 19; Kazakistan, 20; Libya, 21; Malezya, 22; Mauritius, 23; Meksika, 24; Namibya, 25; Panama, 26; Paraguay, 27; Peru, 28; Romanya, 29; Rusya, 30; Güney Afrika, 31; Tayland, 32; Türkiye.

Şekil 2. İnsani Gelişme Endeksi (hdi) Serisine Ait Grafikler (1990-2021)



**Not:** 1; Arnavutluk, 2; Arjantin, 3; Ermenistan, 4; Botsvana, 5; Brezilya, 6; Bulgaristan, 7; Çin, 8; Kolombiya, 9; Kosta Rika, 10; Dominik Cumhuriyeti, 11; Ekvador, 12; Fiji, 13; Gabon, 14; Guatemala, 15; Guyana, 16; Irak, 17; Jamaika, 18; Ürdün, 19; Kazakistan, 20; Libya, 21; Malezya, 22; Mauritius, 23; Meksika, 24; Namibya, 25; Panama, 26; Paraguay, 27; Peru, 28; Romanya, 29; Rusya, 30; Güney Afrika, 31; Tayland, 32; Türkiye.

Analiz kapsamında ilk olarak yatay kesit bağımlılığı sınaması yapılmıştır bunun için Breusch ve Pagan LM (1980) testinden yararlanılmıştır. İkinci aşamada ise homojenlik sınaması yapılmıştır ve bunun için Pesaran ve Yamagata (2008) tarafından geliştirilen test istatistiğinden yararlanılmıştır.

Üçüncü aşamada Pesaran (2007) tarafından geliştirilen CADF testi sonuçlarına bakılmıştır (Bozkurt, 2012; Balmumcu ve Bozkurt, 2020; Bozkurt ve Balmumcu, 2018; Bozkurt ve Yanardağ, 2017; Gökteş vd., 2018, Gökteş vd., 2019).

Son olarak seriler arasında kısa dönemli bir ilişkinin varlığını tespit edebilmek için Dumitrescu ve Hurlin (2012) tarafından geliştirilen Panel Granger Nedensellik Testi sonuçlarına, uzun dönemli bir ilişkinin tespiti içinde Westerlund (2007) Panel Eşbütünleşme Testi sonuçlarına bakılmıştır. Dumitrescu ve Hurlin (2012) tarafından geliştirilen Panel Granger Nedensellik Testinin boş hipotezi nedensellik ilişkisinin olmaması, alternatif hipotezi de en az bir yatay kesitte nedensellik ilişkisinin olması üzerine kurulmaktadır (Bozkurt vd., 2021).

## SONUÇ

Araştırmanın uygulama kısmında öncelikle tanımlayıcı istatistiklere bakılmıştır. Araştırmada kullanılan her bir seriye için tanımlayıcı istatistikler 3 numaralı tabloda verilmiştir.

**Tablo 3.** Serilere İlişkin Tanımlayıcı İstatistikler

Değişkenler	Gözlem Sayısı	Ortalama	Standart Hata	Minimum	Maksimum
loggdp	1024	3.588	0.353	-0.315	-0.069
loghdi	1024	-0.159	0.046	1.358	4.203

Uygulamanın ikinci aşamasında söz konusu seriler için yatay kesit bağımlılığı sınaması yapılmıştır ve bunun için de Breusch ve Pagan LM (1980) Testi sonuçlarına bakılmıştır. Testin sonuçları Tablo 4'te verilmiştir.

**Tablo 4.** Yatay Kesit Bağımlılığı Test Sonuçları

Değişkenler	Breusch Pagan LM Test İstatistiği	Olasılık Değeri
loggdp	4946.60	0,0000
loghdi	11572.04	0,0000

Tablo 4 incelendiğinde, Breusch ve Pagan LM (1980) Test İstatistiğine göre söz konusu seri grubunun yatay kesit bağımlılığı içerdiği sonucu tespit edilmiştir.

Uygulamanın bir diğer aşamasında ise eğim heterojenliğinin varlığı araştırılmıştır bunun içinde Pesaran ve Yamagata (2008) eğim heterojenliği testi sonuçlarına bakılmıştır ve 5 numaralı tabloda da görüldüğü üzere, kurulan modelin eğiminin heterojen olduğu tespit edilmiştir.

**Tablo 5.** Eğim Heterojenliği Test Sonuçları

	Değer
$\hat{\Delta}$	3.078*
$\tilde{\Delta}_{adj}$	3.315*

Not: \* %1 anlamlılık düzeyini ifade etmektedir.

Uygulamanın dördüncü aşamasında ise serilerin durağanlığı sınanmıştır ve her iki serinin yatay kesit bağımlılığı içermesi sebebiyle bu noktada Pesaran (2007) tarafından geliştirilen CADF Panel Birim Kök Testi sonuçlarına bakılmıştır. 6 numaralı tablo bu sonuçlar verilmiştir. Sonuçla her iki serisinde düzeyde durağan olduğunu göstermiştir.

**Tablo 6.** Panel Birim Kök (CADF) Test Sonuçları

Değişkenler		Z[t-bar]	Olasılık Değeri
loggdp	Düzeyde	-6.889	0.000
loghdi	Düzeyde	-4.065	0.000

Uygulamanın beşinci aşamasında ise iki değişken arasında bir nedensellik ilişkisinin kısa dönem için var olup olmadığı tespit etmek için Dumitrescu ve Hurlin (2012) tarafından geliştirilen nedensellik testinin sonuçlarına bakılmıştır. Bu sonuçlar ise 7 numaralı tabloda verilmiştir.

**Tablo 7.** Granger Panel Nedensellik Test Sonuçları

	1 Gecikme Uzunluğu			2 Gecikme Uzunluğu			3 Gecikme Uzunluğu		
	$W_{N,T}^{Hnc}$	$Z_{N,T}^{Hnc}$	$Z_N^{Hnc}$	$W_{N,T}^{Hnc}$	$Z_{N,T}^{Hnc}$	$Z_N^{Hnc}$	$W_{N,T}^{Hnc}$	$Z_{N,T}^{Hnc}$	$Z_N^{Hnc}$
logdp → loghdi	4.818	15.271*	13.100*	4.224	6.291*	4.889*	5.397	5.537*	3.895*
loghdi → loggdp	3.610	10.440*	8.871*	4.058	5.823*	4.495*	5.361	5.454*	3.829*

Not: \* %1 düzeyinde istatistiksel anlamlılığı göstermektedir.



7 numaralı tablo incelendiğinde kişi başına GSYİH'nın göstergesi olan gdp değişkeni ile insani gelişme endeksini gösteren hdi değişkeni arasında kısa dönemde çift taraflı bir nedensellik ilişkisinin olduğu sonucuna ulaşıldığı görülmektedir.

Son olarak iki değişken arasında bir eşbütünlük ilişkisinin uzun dönem için var olup olmadığı tespit etmek için Westerlund (2007) tarafından geliştirilen eşbütünlük testinin sonuçlarına bakılmıştır. Bu sonuçlar ise 8 numaralı tabloda verilmiştir.

**Tablo 8.** Westerlund (2007) Panel Eşbütünlük Test İstatistiği Sonuçları

Test	Değer	Z-Değeri	Olasılık Değeri
$G_t$	-2.580	-5.006	0.000
$G_a$	-9.427	-2.323	0.010
$P_t$	-14.012	-5.598	0.000
$P_a$	-11.005	-8.197	0.000

Tablo 8'e bakıldığında kişi başına GSYİH serisi ile insani gelişme endeksi serisi arasında uzun dönemli bir eşbütünlük ilişkisinin olduğu görülmektedir.

## TARTIŞMA VE SONUÇ

Sürdürülebilir kalkınma hedefleri kapsamında insani gelişme kavramı ve insani gelişmişliğin nasıl sağlanacağı konuları literatürde önemli tartışma alanlarından birini oluşturmaktadır. Özellikle küreselleşme süreci ile birlikte orta ve düşük gelir seviyesine sahip gelişmekte olan ülkeler için insani gelişme kavramı son derece önemlidir. Literatüre bakıldığında özellikle 80'li yıllara kadar olan süreçte ülke ekonomilerinin sadece gelir eksenli bir bakış açısı ile ekonomik büyümeyi sağlama hedefine odaklandıkları görülmektedir. Ancak ekonomik büyüme kavramına, gelirin dağılımı ve toplumsal refahın artırılması noktasında yapılan ciddi eleştiriler, iktisadi kalkınma kavramının öne çıkmasına neden olmuştur. Yine söz konusu bu iktisadi kalkınma odaklı yaklaşım, insani gelişme kavramının da önemini arttırmıştır. Tabii ki bu yaklaşım iktisadi büyüme kavramını önemsiz hale getirmek bir yana, özellikle sürdürülebilir bir büyüme hedefi doğrultusunda, üretim artışının sağlanması yanında sağlanan bu gelir artışının toplumun insani gelişimini de arttıracak şekilde adil bir şekilde dağıtılmasına vurgu yapmaktadır. Dolayısıyla politika yapıcıların temel hedefi, bir toplumu sadece ekonomik değil aynı zamanda sosyal olarak ta ileri bir seviyeye ulaştırmak olmalıdır.

Diğer taraftan gerek insani gelişmenin ekonomik büyüme ve kalkınma üzerinde, gerekse ekonomik büyümenin insani gelişmişlik üzerinde karşılıklı bir etkisi söz konusudur. Bu bağlamda insani gelişme sürdürülebilir kalkınmanın da en önemli unsurlarından birisi olmuştur. Burada en önemli husus gerek mikro düzeyde gerekse makro düzeyde adil bir gelir dağılımının sağlanmasıdır. Diğer bir ifadeyle makro düzeyde ekonomik büyüme sonucu ortaya çıkan gelir artışının bireyler arasında adil dağılımı ile mikro düzeyde hane halkları arasında söz konusu gelirin adil dağılımı büyük önem arz etmektedir.

Ayrıca hükümet politikalarının, toplumun gerçek ihtiyaçlarını karşılayacak ve insani bir yaşam standardını sunacak şekilde programlanması son derece önemlidir. Bu noktada başta beslenme ve barınma olmak üzere, sağlık ve eğitim alanında uygulanan politikalar insani gelişme düzeyi üzerinde de son derece önemli bir etkiye sahiptir. Yine uygulanan teşvik ve vergi politikaları da gelirin yeniden dağılımı üzerinde büyük önem arz etmektedir. Özellikle eğitim ve sağlık alanında yapılan hükümet harcamaları sosyal refahı da etkilemesi noktasında son derece etkili hükümet politikası enstrümanlarıdır. Dolayısıyla hiçbir ekonomik büyüme ve kalkınma stratejisi sosyal faydayı ve refahı artırma hedefini ez geçemez ve sosyal faydayı ez geçen her ekonomik büyüme stratejisi başarısız olmaya mahkumdur.

Bu kapsamda bu çalışmada insani gelişme ile ekonomik büyüme arasında literatürde de bahsedilen pozitif yönlü ilişkinin varlığı gelişmekte olan ülkeler için test edilmeye çalışılmıştır. Yapılan analizler sonucunda ise uzun dönemde insani gelişme ile ekonomik büyüme arasında bir eşbütünleşme ilişkisinin olduğu tespit edilmiştir. Ayrıca kısa dönem için yapılan nedensellik analizi sonucunda da her iki değişken arasında çift taraflı bir nedensellik ilişkisi vardır.

## References

- Abraham, T. W. and Ahmed, U. A. (2011). Economic Growth and Human Development Index in Nigeria: An Error Correction Model Approach. *International Journal of Administration and Development Studies*, 2(1), 239-254.
- Appiah, M., Amoasi, R. and Frowne, D. I. (2019). Human Development and Its Effects on Economic Growth and Development. *International Research Journal of Business Studies*, 12(2), 101-109.
- Aydın, M. (2019). İnsani Gelişme ve Ekonomik Büyüme İlişkisi: Türkiye Üzerine Ampirik Bir Çalışma. *Siyaset, Ekonomi ve Yönetim Araştırmaları Dergisi*, 7(4), 33-42.
- Balcı, E. ve Özcan, S. (2019). İnsani Gelişmişlik ve Büyüme Arasındaki İlişki: OIC Ülkeleri Üzerinde Bir Analiz. *Sakarya İktisat Dergisi*, 8(3), 222-235
- Balmumcu, Ö. ve Bozkurt, K. (2020). Gelişmekte Olan Ülkelerde Ekonomik Büyüme ve Cari İşlemler Dengesi Üzerine Bir Panel Veri Analizi. *Ekonomi Politika ve Finans Araştırmaları Dergisi*, 5(2), 292-307.
- Bhowmik, D. (2018). Nexus Between Growth and Human Development Index: Evidence from India and Indian States. *Assumption University-eJournal of Interdisciplinary Research (AUeJIR)*, 3(2), 96-118.
- Birdsall, N., Ross, D. and Sabot, R. (1995). Inequality and Growth Reconsidered: Lessons from East Asia. *World Bank Economic Review*, 9.
- Bozkurt, K. (2012). Dışsal Teknolojik Şokların Gelişmekte Olan Ülkelerin Büyüme Sürecine Etkileri. Yayınlanmamış Doktora Tezi, Muğla Sıtkı Koçman Üniversitesi Sosyal Bilimler Enstitüsü, Muğla.
- Bozkurt, K. ve Balmumcu, Ö. (2018). Beşeri Sermaye ve Ekonomik Büyüme: Gelişmekte Olan Ülkeler İçin Bir Panel Veri Analizi. *Uluslararası İktisadi ve İdari İncelemeler Dergisi*, Prof. Dr. Harun Terzi Özel Sayısı, 391-405.
- Bozkurt, K. ve Yanardağ, M. Ö. (2017). Enerji Tüketimi ve Ekonomik Büyüme: Gelişmekte Olan Ülkeler İçin Bir Panel Eşbütünleşme Analizi. *Yönetim ve Ekonomi Araştırmaları Dergisi*, 15(1), 194-213.
- Bozkurt, K. ve Yanardağ, M. Ö. (2020). *Ekonomik Büyüme ve İnsani Gelişim İndeksi Arasındaki İlişki: OECD Ülkeleri Üzerine Bir Analiz*. Sosyal, Beşeri ve İdari Bilimler Alanında Akademik Araştırmalar İçerisinde, Platanus Publishing, Ankara. 201-214.
- Bozkurt, K., Armurçuoğlu Tekin, H. ve Can Ergün, Z. (2021). An Investigation of Demand and eExchange Rate Shocks in the Tourism Sector. *Applied Economic Analysis*, 29(86), 171-188.
- Breusch, T. S. and Pagan, A. R. (1980). The Lagrange Multiplier Test and Its Applications to Model Specification Tests in Econometrics. *The Review of Economic Studies*, 47(1), 239-253.
- Case, A. and Deaton, A. (2003). *Broken Down by Age and Sex: How Our Health Declines*. Cambridge, MA: National Bureau of Economic Research.
- Duflo, E. (2001). *The Medium Run Effects of Educational Expansion: Evidence from a Large School Construction Program in Indonesia*. Massachusetts Institute of Technology, Department of Economics Working Paper, 01-46.
- Dumitrescu, E. I. and Hurlin, C. (2012). Testing for Granger Non-Causality in Heterogeneous Panels. *Economic Modelling*, 29(4), 1450-1460.
- Erdem, E. ve Çelik, B. (2019). İnsani Gelişme ve Ekonomik Büyüme İlişkisi: Bazı Afrika Ülkeleri Üzerine Bir Uygulama. *Bingöl Ün. Sosyal Bilimler Enstitüsü Dergisi*, 9(9), 13-36.
- Göktaş, P., Pekmezci, A. ve Bozkurt, K. (2018). *Ekonometrik Serilerde Uzun Dönem Eşbütünleşme ve Kısa Dönem Nedensellik İlişkileri*. Ankara: Gazi Kitabevi.
- Göktaş, P., Pekmezci, A. ve Bozkurt, K. (2019). *Ekonometrik Serilerde Uzun Dönem Eşbütünleşme ve Kısa Dönem Nedensellik-Makroekonomik Verilerle Eviews ve Stata Uygulamaları*. Ankara: Gazi Kitabevi.

- Grubaugh, S. G. (2015). Economic Growth and Growth in Human Development. *Applied Econometrics and International Development*, 15(2), 5-16.
- Güney, T. (2017). Ekonomik Özgürlük ve İnsani Gelişmişlik. *Hitit Üniversitesi Sosyal Bilimler Enstitüsü Dergisi*, 10(2), 1109-1120.  
<https://data.worldbank.org/indicator>
- Hurt, L.S., Ronsmans, C. and Saha, S. (2004). Effects of Education and Other Socioeconomic Factors on Middle Age Mortality in Rural Bangladesh. *Journal of Epidemiology and Community Health*, 58, 315-320.
- Marmot, M. (2012). Social Determinant of Health Inequality. *Lancet*, 365,1099-1104.
- Öztürk, S., ve Suluk, S. (2020). The Granger Causality Relationship Between Human Development and Economic Growth. *International Journal of Research in Business and Social Science*, 9(6), 143-153
- Pesaran, M. H. (2007). A Simple Panel Unit Root Test in the Presence of Cross-Section Dependence. *Journal of Applied Econometrics*, 22(2), 265-312.
- Pesaran, M. H. and Yamagata, T. (2008). Testing Slope Homogeneity in Large Panels. *Journal of Econometrics*, 142(1), 50-93.
- Ramirez, A., Ranis, G. and Stewart, F. (1997). *Economic Growth and Human Development*. Center Discussion Paper 787. New Haven: Yale University Economic Growth Center.
- Ramirez, A., Ranis, G. and Stewart, F. (1998). *Economic Growth and Human Development*. Working Paper Yale University. 18.
- Ranis, G. (2004). Human Development and Economic Growth. Yale University Center Discussion Paper No.887.
- Shahbaz, M. Iqbal, A. and Butt, M. S. (2011). Testing Causality Between Human Development and Economic Growth: a Panel Data Approach. *International Journal of Education Economics and Development*, 2(1), 90-102.
- Suri, T. Boozer, M. A. Ranis, G. and Stewart, F. (2011). Paths to Success: The Relationship Between Human Development and Economic Growth. *World Development*, 39(4), 506-522.
- Uçan, O. ve Koçak, E. (2018). İnsani Gelişme Endeksi ile Büyüme İlişkisi: Pedroni Eşbütünleşme Örneği. *Journal of Politics, Economy and Management*, 1(2), 55-61.
- Westerlund, J. (2007). Testing for Error Correction in Panel Data. *Oxford Bulletin of Economics and Statistics*, 69 (6), 709-748.

#### **Teşekkür**

Çalışmada emeği geçen Kurtuluş Bozkurt ve Aytaç Pekmezci hocama katkılarından dolayı teşekkür ederim.

#### **Çıkar Çatışması**

Yazarlar çıkar çatışması olmadığını beyan etmişlerdir.



## Kadınların İş Hayatlarından Memnuniyetlerinin Karşılaştırılması: İki Devlet Kurumu Örneği

**H. Eda Ustaibrahimoğlu<sup>1\*</sup>, Oğulcan Kaya<sup>1</sup>, İsmail Soner Güngör<sup>1</sup>, Şahika Gökmen<sup>1,2</sup>**

<sup>1</sup> Ankara Hacı Bayram Veli Üniversitesi, İktisadi ve İdari Bilimler Fakültesi, Ekonometri Bölümü

<sup>2</sup>Uppsala University, Statistics Department

\*Sorumlu yazar e-mail: ustaibrahimoğlu.hanifeeda@hbv.edu.tr

### Özet

Kadınların iş hayatına katılımı, tarih boyunca pek çok zorlukla dolu olmuş ve karşılaştıkları engelleri aşabilmek için büyük mücadeleler vermiştir. Örneğin, 1919 yılında "Yamanlar" adlı tiyatro oyununda rol alan Jale Hanım, tutuklanma riskiyle karşı karşıya kalmıştır; ancak Cumhuriyet'in ilanından sonra aldığı destekle işini daha rahat yapabirmiştir. Tarihte yer alan benzer örnekler, kadınların iş hayatında hak mücadelesi verirken karşılaştığı zorlukları açıkça ortaya koymaktadır. Bu gibi zorlukların tanımlanabilmesi ve iyileştirme adımlarının atılması için literatürde pek çok çalışma yapıldığı ve bu çalışmaların özellikle son yıllarda toplumsal cinsiyet eşitliği konusunun da popülerlik kazanmasıyla birlikte arttığı görülmektedir. Bu bağlamda literatürdeki çalışmaların çoğunluğunun, özel sektörde çalışan kadınların iş hayatlarındaki memnuniyetine odaklandığı dikkati çekmekte ve kamu sektöründe çalışan kadınların deneyimlerinin bu alanda incelendiğine rastlanılmamaktadır. Oysa kamu kurumunda çalışan kadınların da benzer zorluklarla karşılaşması olası görülmektedir. Diğer yandan genel olarak kadınların iş hayatındaki başarılarının ve memnuniyetlerinin sadece bireysel düzeyde değil, aynı zamanda toplumsal ve ekonomik düzeyde de önemli etkileri vardır. Kadınların iş gücüne katılımı, ekonomik büyümeyi ve kalkınmayı desteklerken, toplumda cinsiyet eşitliği ve adalet için de bir ölçüt oluşturur. Dolayısıyla, kadınların iş hayatındaki deneyimleri ve memnuniyetleri, sadece bireysel refahları değil, aynı zamanda toplumsal ve ekonomik açıdan da büyük bir öneme sahiptir. Bu bağlamda literatürde dikkati çeken boşluk ele alınarak bu çalışmada, Ankara'da seçilen iki önemli devlet kurumunda çalışan kadınların iş memnuniyetlerinin araştırılması ve karşılaştırılması amaçlanmıştır. Dolayısıyla, söz konusu çalışmanın, kadınların iş hayatındaki deneyimlerini anlamak ve onların karşılaştığı zorlukları belirlemek için politika yapıcılara ve ilgili alanda çalışanlara bir bakış açısı sunacağı düşünülmektedir. Ayrıca kadınların iş yaşamındaki deneyimlerini ve memnuniyetlerini anlamanın, iş ortamlarını daha kapsayıcı ve destekleyici hale getirmek için önemli bir adım olma potansiyeline sahiptir. Çalışmada, ele alınan iki devlet kurumundaki kadın çalışanlardan çevirim içi anket yoluyla derlenen verilerden yola çıkarak bu kurumlarda çalışan kadınların memnuniyetlerine ilişkin istatistiksel analizlerin yapılması ve verilerin görselleştirme teknikleriyle sunulması planlanmaktadır.

**Anahtar Kelimeler:** Toplumsal Cinsiyet Eşitliği, Kadınların İş Hayatına Bakışı, Anket Çalışması

### GİRİŞ

Kadınların iş hayatına katılımı, tarih boyunca pek çok zorlukla dolu olmuş ve karşılaştıkları engelleri aşabilmek için büyük mücadeleler vermiştir. Bu zorlukların tanımlanabilmesi ve iyileştirme adımlarının atılması için literatürde pek çok çalışma yapıldığı ve bu çalışmaların özellikle son yıllarda toplumsal cinsiyet eşitliği konusunun da popülerlik kazanmasıyla birlikte arttığı görülmektedir. 'Takım ve Timuroğlu (2006) Çalışan Memnuniyeti ve Algının Örgütsel Desteğin Kadın Çalışanların İş-Yaşam Dengesi ve Örgütsel Vatandaşlık Davranışı ile İlişkisi: Tekstil Sektöründe Bir Uygulama' ve 'Yılmaz (2019) Kadınların İş Hayatlarında Karşılaştığı Cam Tavan Sendromu' gibi özel sektörde çalışan kadınların iş hayatlarındaki memnuniyetine odaklandığı dikkati çekmekte ve kamu sektöründe çalışan

kadınların deneyimlerinin bu alanda incelendiğine rastlanılmamaktadır. Oysa kamu kurumunda çalışan kadınların da benzer ve daha farklı zorluklarla karşılaşması son derece normaldir. Bu düşünceden yola çıkarak, bu çalışmada iki kamu kurumunda çalışan kadınların iş hayatındaki deneyimleri, memnuniyetleri ve karşılaştıkları zorlukların incelenmesi amaçlanmaktadır.

Çalışma konumuz genel hatlarıyla çalışan kadınların aile yapısını, aile bütçesine katkı sağlama durumunu, çalışma ortamlarına bakışlarını ve karşılaştıkları zorlukları anket çalışmasıyla ele almaya çalışmaktadır. Bu bağlamda;

Çalışan kadınların genel aile yapısı dikkate alınır; Türkiye’de ailelerin genellikle geniş ve katmanlı bir yapıya sahip olduğu dikkat çekmektedir. Kadınlar ise bu yapı içerisinde genellikle önemli roller üstlenirler ve geleneksel olarak ev işleri ve çocuk bakımı gibi rollerde daha fazla sorumluluk almaktadırlar. Ancak, son yıllarda Türkiye’de kadınların iş gücüne katılımının artması ve modernleşen toplumun getirileriyle birlikte aile dinamiklerinin değiştirmeye başladığı görülmektedir. Bu durum toplum ve aile içerisindeki rollerin ve sorumlulukların yeniden tanımlanmasına neden olmaktadır.

Kadınların aile bütçesine katkı sağlama durumu ele alındığında bu durumun genellikle; ekonomik faktörlere, eğitim düzeyine, coğrafi konuma ve kültürel faktörlere bağlı olduğu görülmektedir. Kadınların aile bütçesine katkıda bulunmak için çalışmaları ise günümüzde ailenin yaşam standartlarını yükseltebilir ve bu sayede çocukların eğitimine daha fazla kaynak ayırmayı mümkün kılması aile üyelerinin genel refahını yükseltmesi gibi olumlu gelişmelere yol açabilmektedir.

Diğer yandan çalışma ortamı ve bu ortamda karşılaştıkları zorluklar farklı alt başlıklarla karşımıza çıkabilmektedir. ‘Parmelee (2023) İş Hayatında Kadının Yeri’ isimli kitabında aşağıdaki özetlediğimiz başlıklardan bahsetmiştir;

i. İş Yeri Kültürü ve Aile Desteği: Kadınların iş ortamına olan bakışı, çalıştıkları iş yerinin kültürüne ve yönetim politikalarına bağlı olarak değişebilmektedir. Kadın dostu çalışma ortamları, kadınların iş hayatına katılımını teşvik edebilmekle birlikte bu aşamada aile desteği de önemli bir yer tutmaktadır.

ii. Eğitim ve Kariyer Fırsatları: Kadınların eğitim düzeyi ve kariyer fırsatlarına erişimi, iş ortamına olan bakışlarını belirleyebilmektedir.

iii. Cinsiyet Ayrımcılığı ve İş Yeri Zorlukları: Cinsiyet ayrımcılığı bazı iş ortamlarında var olabilir ve bu durum kadınların iş hayatlarında karşılaştıkları zorluklara olan bakışlarını etkileyebilmektedir. Buna ilave olarak, ücret eşitsizliği, terfi fırsatlarında ayrımcılık ve cinsiyete dayalı taciz gibi sorunlar, kadınların iş ortamına olan güvenini ve motivasyonunu azaltan faktörler olarak görülebilmektedir.

iv. Kadınların Güçlenmesi ve Toplumsal Değişim: Son yıllarda Türkiye’de kadın haklarına ve cinsiyet eşitliğine yönelik farkındalık artmıştır. Bu da kadınların iş ortamına olan bakışını olumlu yönde etkileyebilir. Kadınların güçlenmesi, toplumsal cinsiyet normlarının değişmesine ve iş ortamlarında daha adil bir atmosferin oluşmasına katkı sağlayabilir.

## LİTERATÜR

Kadınların iş hayatına girmesi çok sancılı ve kaos dolu bir süreç olmuştur. Tarihte bilinen ilk olarak 1923 yılında Dersaadet Telefon Anonim Şirket-i ilan vererek kadın memurlar aradığını bildirmiştir. Ancak kadınlardan yeterli atak göremeyen Emine Seher Ali Hanım (1913) “Kadınlar Dünyası” adlı dergide bu durumu eleştirmiş ve bunun sonucu olarak kadınlar harekete geçmeye başlamıştır. Yine başka bir örnek olarak, 1919 yılında ‘Yamanlar’ adlı tiyatro oyununda rol alan Jale Hanım tutuklanma tehlikesiyle karşılaşmış ancak Cumhuriyet’in ilanından sonra gördüğü destekle rahatça işini yapabirmiştir. Bilimde, sanatta ve medeniyette en önde geldiğini iddia eden toplumlarda dahi kadınlar iş hayatında benzer sorunlarla karşılaşabilmektedir. Londra merkezli eğitim yayınları grubu ‘Pearson’

(2019) farklı ülkelerden çalışma çağındaki 6 bin kadın üzerinde yaptığı anket çalışmasında kadınların ırk, yaş ve cinsiyetlerinin iş bulmada engel teşkil ettiği görülmektedir. Bu çalışma ayrıca, finansal kaygılar yaşayan kadınların akılsal sağlıklarını ve stres seviyelerini de korumakta zorlandıklarını göstermiştir. Bu alanda yapılan güncel literatür incelendiğinde;

Takım ve Timuroğlu (2006) '*Çalışan Memnuniyeti ve Algının Örgütsel Desteğin Kadın Çalışanların İş-Yaşam Dengesi ve Örgütsel Vatandaşlık Davranışı ile İlişkisi: Tekstil Sektöründe Bir Uygulama*' başlıklı çalışmaları ilk olarak dikkati çekmektedir. Araştırmacılar söz konusu çalışmada tekstil sektörüne odaklanarak, bu sektörde çalışan kadınlar üzerinde bir saha araştırması yapmıştır. Bu alanda dikkat çeken bir diğer çalışma ise,

Bebekoğlu ve Wasti (2002) '*Çalışan Kadınlara Yönelik Cinsiyet Temelli Düşmanca Davranışların Sebepleri ve Sonuçları Üzerine Bir Araştırma*' başlıklı çalışmasında çalışan kadınlara yönelik cinsiyet jeneratörlerinin arızaları ve sonuçları üzerine bir araştırmadır,

Kaplan, M. (2011) '*Kaplumbağanın Özgürlüğü: Kadınlar ve Ev İçi Emek*' ev kadınlarının görünmez emeği üzerine bir araştırma gerçekleştirmiştir;

Arslan ve Güngör (2020) '*Kadının İş Hayatındaki Yeri ve Karşılaştığı Sorunlar Üzerine Nitel Bir Araştırma Kadınlar*' ekonomik ve toplumsal yaşamın önemli bir parçasını oluşturmakla birlikte aynı zamanda bu yaşamın gerisinde kalmalarını konu alan bir araştırmadır.

Yılmaz (2019) '*Kadınların iş hayatlarında karşılaştığı cam tavan sendromuna odaklandığı tez çalışmasıdır*'. Yılmaz (2019) bu çalışmada Türkiye'deki hizmet örgütlerinde kadınların karşılaştıkları engelleri ve cam tavan sendromunu incelemek ve orta ve üst yönetimde yer alan kadın yöneticilerin deneyimlerini ve başa çıkma stratejilerini analiz etmektedir. Bu çalışmada İstanbul'da çalışan 15 kadın yönetici ile yarı yapılandırılmış görüşmeler yapılmıştır. Sonuçlar, kadın yöneticilerin çoğunluğunun daha üst kademelere geçememe nedenini ataerkil toplum yapısına bağladığını göstermektedir'. Türkiye'de kadınların iş hayatlarında yaşadıkları zorlukları ve memnuniyeti dikkate alan çalışmalar bunlarla sınırlı kalmakla birlikte özellikle güncel uluslararası literatürde;

Parmelee ve Emma (2023) '*İş Hayatında Kadının Yeri*' isimli yayınlanan bu konuyu dahada gündeme getirmiştir.

Kadınların iş memnuniyeti ile ilgili literatür genel çerçevesiyle incelendiğinde genel olarak, kadınların hem aile yaşamlarında hem de iş ortamlarındaki verimlerini etkileyen en önemli faktörlerden birinin, kadınların iş ortamlarından memnuniyetleri olduğu görülmektedir. Bu bağlamda bu çalışma ile Ankara'daki iki devlet kurumunda çalışan kadınların iş memnuniyetlerinin araştırılması amaçlanmaktadır. Bu sayede iki önemli devlet kurumunun yaklaşımları ve olanakları bakımından bir farklılığa yol açıp açmayacaklarının araştırılması hedeflenmiştir. Çalışmanın literatürden farklı olarak devlet kurumunda yürütülüyor olması çalışmanın özgünlüğünü oluşturmaktadır.

Bu bağlamda kadınların iş memnuniyetlerinin incelenmesi için söz konusu devlet kurumlarından anket yoluyla derlenen verilerden yola çıkarak kadınların memnuniyetlerine ilişkin istatistiksel analizlerin yapılması ve verilerin veri görselleştirme teknikleriyle sunulması planlanmıştır. Söz konusu çerçevede çalışma ele alındığında, çeşitlilik ve kapsayıcılık girişimleri de dahil olmak üzere kurumsal politika ve uygulamaların toplumsal cinsiyet eşitliğini teşvik etme ve iş dünyasındaki kadınlar için destekleyici bir ortam yaratmadaki rolünü keşfetmesi bakımından çalışmanın literatüre katkı sağlayabileceği ve gelecek çalışmalara ilham olabileceği düşünülmektedir.



## VERİ GÖRSELLEŞTİRME

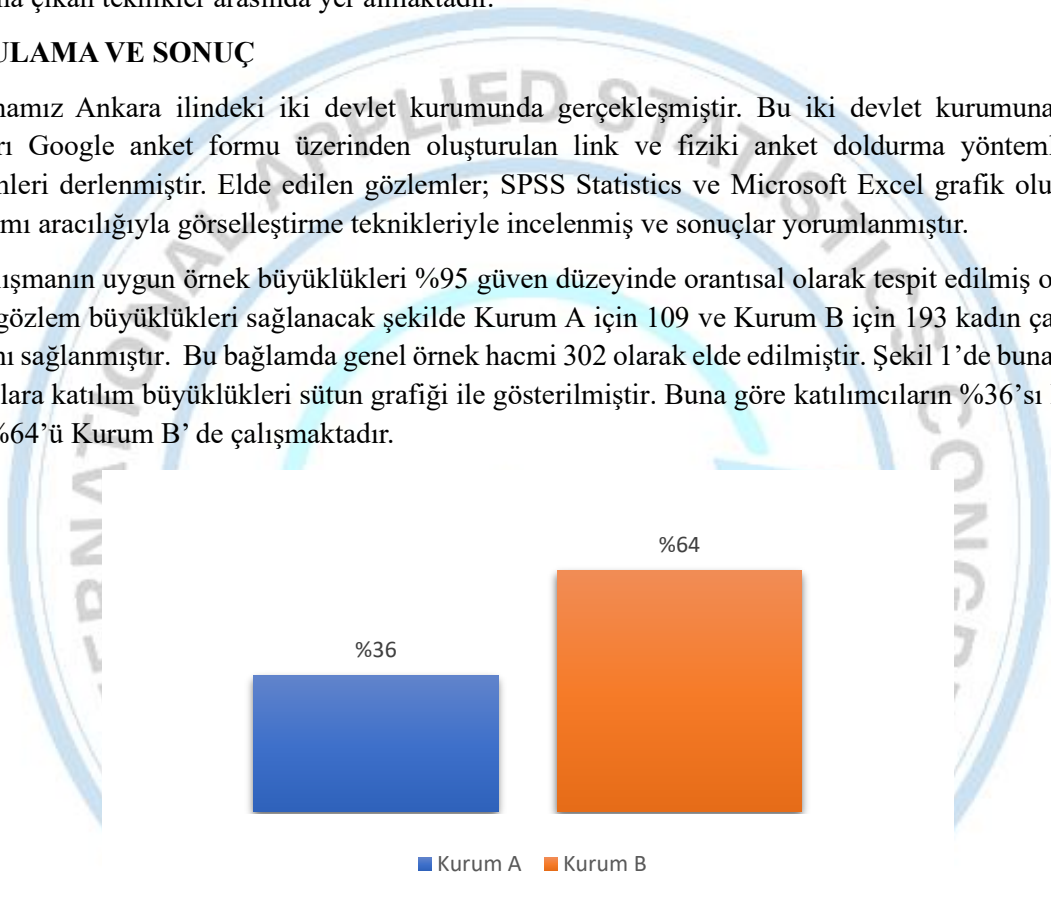
Veri görselleştirme; verileri insan beyninin anlaması ve içgörü alması için, daha kolay hale getirmek üzere grafik gibi görsel bir bağlama çevirme uygulamasıdır. Grafiklerde bulunan verileri, görsel nesnelere (noktalar, çizgiler veya çubuklar) olarak kodlayarak anlaşılır kılmak için kullanılan teknikleri ifade eder.

Veri görselleştirmenin önemi; çeşitli veri kaynaklarından gelen büyük miktardaki verinin işlenerek, ham verilerin anlaşılması ve kullanılmasının zor olduğu durumlarda görsel olarak anlaşılması daha kolay bir çıkarım yapma fırsatı sağlamasıdır. Bu bağlamda özellikle son yıllarda büyük veri çalışmalarının ve kodlama programlarına olan ilginin de artmasıyla birlikte veri görselleştirme teknikleri ön plana çıkan teknikler arasında yer almaktadır.

## UYGULAMA VE SONUÇ

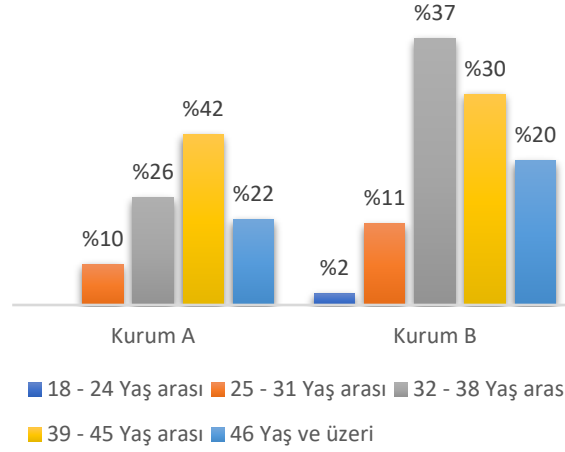
Çalışmamız Ankara ilindeki iki devlet kurumunda gerçekleştirilmiştir. Bu iki devlet kurumuna anket soruları Google anket formu üzerinden oluşturulan link ve fiziki anket doldurma yöntemleri ile gözlemleri derlenmiştir. Elde edilen gözlemler; SPSS Statistics ve Microsoft Excel grafik oluşturma programı aracılığıyla görselleştirme teknikleriyle incelenmiş ve sonuçlar yorumlanmıştır.

Çalışmanın uygun örnek büyüklükleri %95 güven düzeyinde orantısal olarak tespit edilmiş olup, en az bu gözlem büyüklükleri sağlanacak şekilde Kurum A için 109 ve Kurum B için 193 kadın çalışanın katılımı sağlanmıştır. Bu bağlamda genel örnek hacmi 302 olarak elde edilmiştir. Şekil 1’de buna ilişkin kurumlara katılım büyüklükleri sütun grafiği ile gösterilmiştir. Buna göre katılımcıların %36’sı Kurum A ve %64’ü Kurum B’de çalışmaktadır.



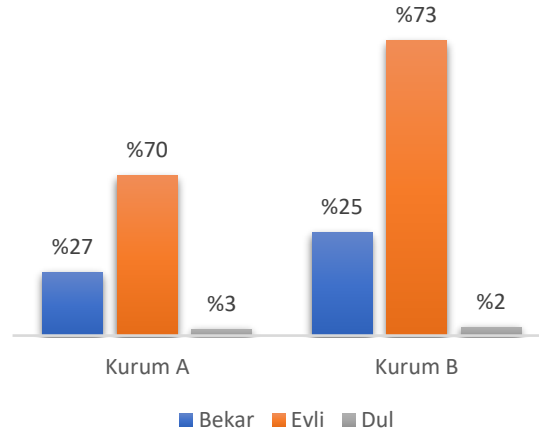
Şekil 6. Kurumlara göre anket çalışmasına katılanların dağılımı.

Şekil 2’de ankete katılan kadınların kurumlara göre yaş dağılımları çubuk grafiğiyle gösterilmektedir. Bu grafiğe göre Kurum A’da çalışanlar için 39-45 yaş arası seçeneği yoğunlukta olsa da Kurum B’de bu seçenek 32-38 yaş arası seçeneğindedir. Buna göre Kurum B’nin daha genç bir kadın çalışan grubu olduğu söylenebilir.



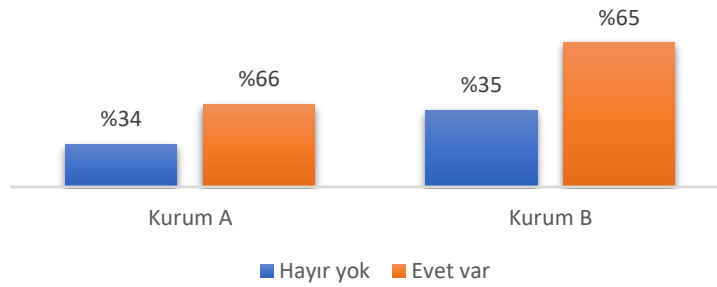
Şekil 7. Kurumlara göre katılımcıların yaş dağılımlarına ilişkin çubuk grafiği.

Şekil 3 iki kurumdan ankete katılan kadınların medeni durumlarına ilişkin bilgileri göstermektedir. Bu bağlamda Şekil 3'e göre iki kurumda çalışan kadınlar, medeni durumları açısından benzer özellik göstermiştir.



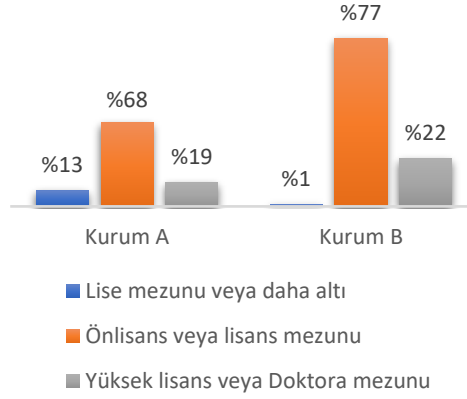
Şekil 8 Kurumların medeni durum dağılımına ilişkin çubuk grafiği

İki kurumda da 'Çocuğunuz var mı?' sorusuna verilen cevaplar Şekil 4'te grafik ile gösterilmiştir. Buna göre iki kurumda da çocuk sahibi olan kadınların dağılımı benzerlik göstermektedir.



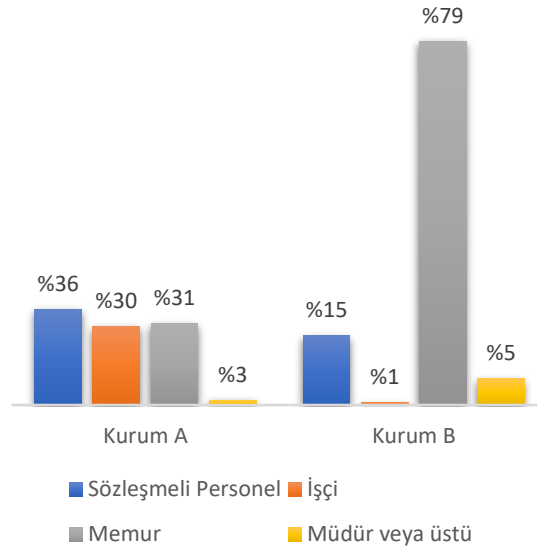
Şekil 9 "Çocuğunuz var mı?" sorusuna verilen cevapların dağılımına ilişkin çubuk grafiği.

İki kurumda da son bitirilen eğitim düzeyini Kurum A da katılımcılarımızın %13 oranında lise mezunu ve daha altı cevabı alırken Kurum B de bu oran %1'dir. Önlisans ve daha üzeri eğitim durumlarında ise iki kurumda da benzer gözlemler görülmektedir. Kurum B daha yüksek eğitim seviyesi kaydetmiştir.



Şekil 10 Son Bitirdiğiniz Okul Nedir? sorusuna verilen cevapların dağılımına ilişkin çubuk grafiği.

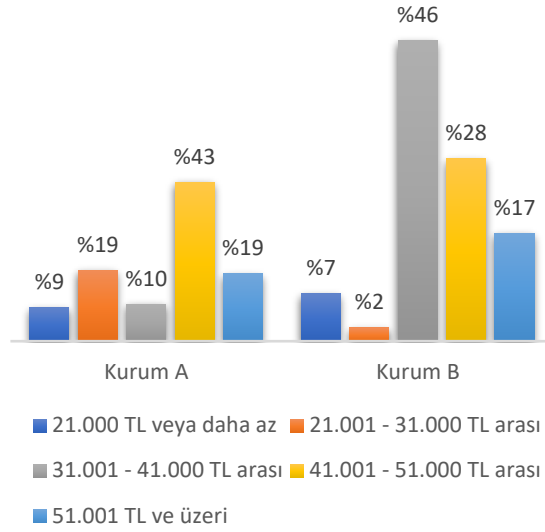
Şekil 6 ise kurumda çalışılan pozisyonlara göre kadınların dağılımlarını göstermektedir. Buna göre, Kurum A da kadın katılımcılarımızın işçi, sözleşmeli personel ve memur oranları benzerlik gösterirken Kurum B' de %79 oranında memur mevki gözlenmiştir, %1 oranında İşçi katılımcı gözlenmiştir.



Şekil 11 “Kurumdaki mevkiniz nedir?” sorusuna verilen cevapların dağılımına ilişkin çubuk grafiği

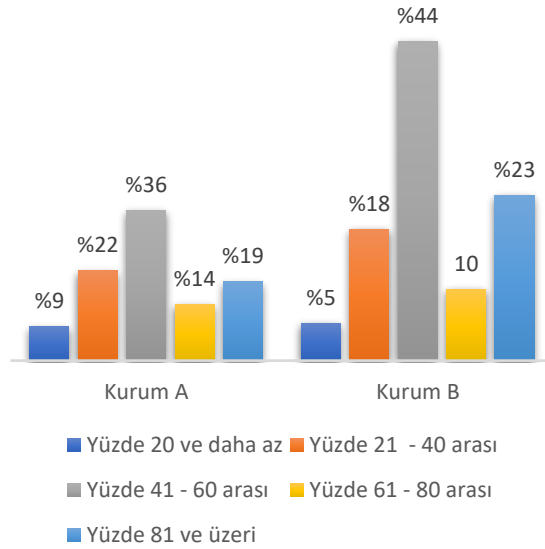
Şekil 7 ise, söz konusu kurumlarda çalışan kadınların gelir dağılımlarını göstermektedir. Bu grafiğe göre, Kurum A katılımcılarının maaş aralığı %46 oranında 31.000-41.000 aralığında %2 oranında ise 21.000-31.000 bin aralığındadır. Diğer yandan Kurum B için bakıldığında ise %43 oranında 41.000-51.000 aralığında, %9 oranında ise 21.000 ve daha az seçeneği gelirinin olduğu dikkati çekmektedir.





Şekil 12 “Aylık geliriniz nedir?” sorusuna verilen cevapların dağılımına ilişkin çubuk grafiği.

Şekil 8, yukarıda paylaşılan bütçelerin de dikkate alınmasıyla, kadınların ailelerinin bütçelerine sağladığı katkıyı göstermektedir. Bu şekilde yer alan grafiğe göre; Kurum A da aylık gelirin hane bütçesini oluşturma oranı %41-60 arasında yer alan kadınların çoğunlukta olduğu ve bu kadınların kurum içerisinde %36 oranına sahip olduğu görülmektedir. Aynı aralık Kurum B için de öne çıkmış ve bu sınıfa katılan kadınların oranı %44 oranı ile daha yüksek bir paya sahip olmaktadır.



Şekil 13 “Aylık geliriniz hane bütçenin ne kadarını oluşturuyor?” sorusuna verilen cevapların dağılımına ilişkin çubuk grafiği.

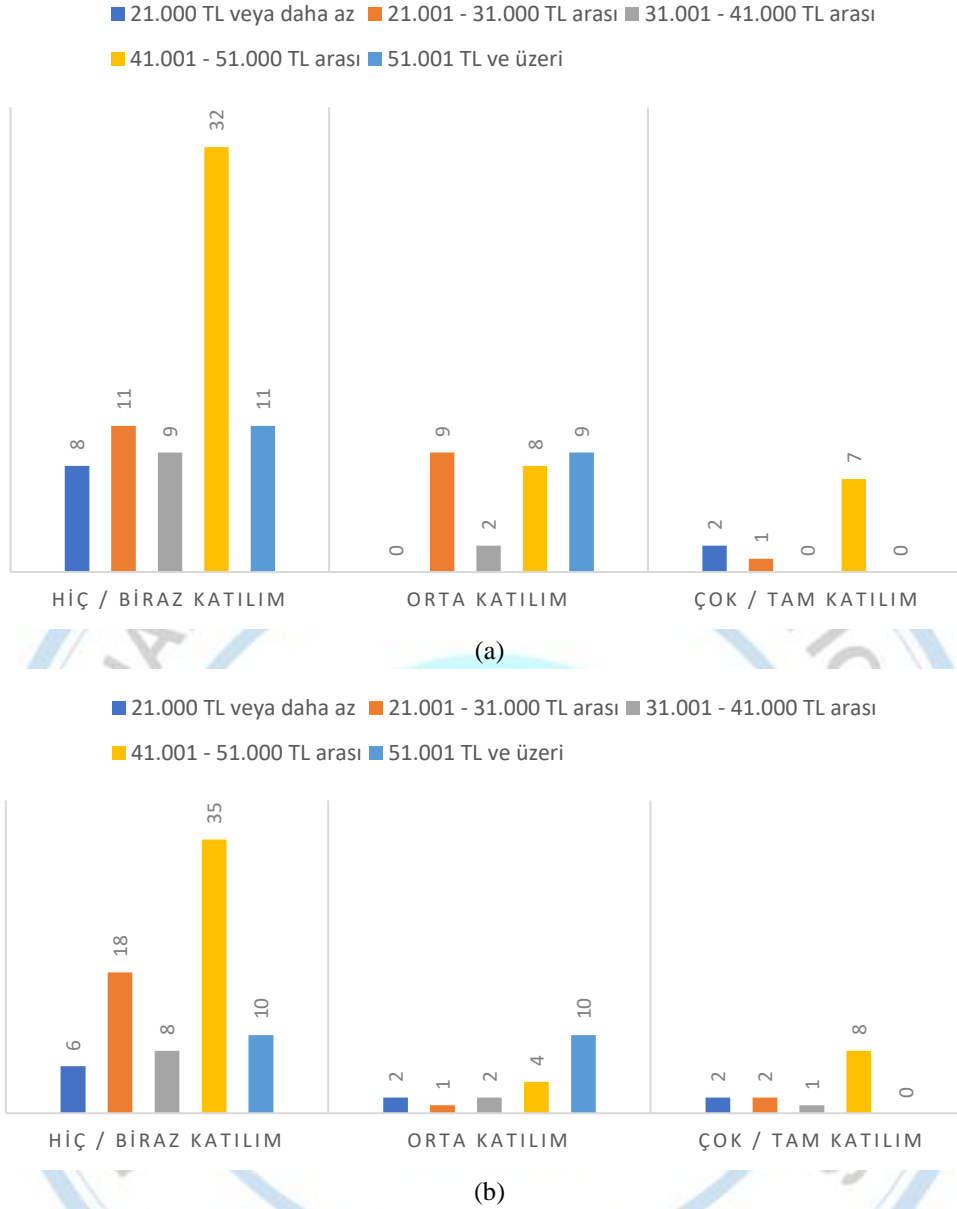
Tablo 1, anket çalışmasında yer alan bazı temel göstergelere ilişkin karşılaştırmalı grafikleri göstermektedir. Bu grafikler incelendiğinde her iki kurumda çalışan kadınların da çoğunluğunun erkek iş arkadaşlarıyla eşit derecede dikkate alındıklarını düşündükleri görülmektedir. Bu durum, devlet kurumlarında çalışan kadınların yaşadıkları iş ortamlarında genel olarak cinsiyetçi bir ortama maruz kalmadıklarının bir göstergesi olarak ele alınabilmektedir. Diğer yandan son iki kriter incelendiğinde, kadınların bu alanda daha çok eğitime ihtiyaç duyduklarını belirtmişlerdir. Bu durumun, “cinsiyet eşitsizliği” kavramı hakkında bir farkındalık ve merak oluşturduğu düşüncesini ortaya çıkarmaktadır.

V. International Applied Statistics Congress (UYİK - 2024)  
Istanbul / Turkey, May 21-23, 2024

Tablo 1. Bazı temel göstergelerin görsel olarak karşılaştırmalı bulguları.

Gösterge	Katılım Durumu			
	Hiç / Biraz Katılım	Orta Katılım	Çok / Tam Katılım	
Fikirlerim erkek iş arkadaşlarımla eşit derecede dikkate alınmıyor	KURUM B	%19	%9	%72
	KURUM A	%30	%14	%56
İşe başlama tarihinden günümüze maaş artışımı yeterli buluyorum	KURUM B	%77	%9	%14
	KURUM A	%64	%16	%20
Yaşadığım sağlık sorunlarında ihtiyaç halinde çekinmeden izin alabileceğimi düşünüyorum	KURUM B	%24	%13	%63
	KURUM A	%22	%12	%66
Çalıştığım kurumun cinsiyet eşitliği ile ilgili farkındalık artırıcı eğitimler almamı sağladığını düşünüyorum	KURUM B	%50	%29	%21
	KURUM A	%65	%25	%10
Çalıştığım kurumda kadınlar için erkek çalışanlar ile eşit fırsatlar sağladığını düşünüyorum	KURUM B	%34	%17	%49
	KURUM A	%45	%17	%38

Aynı zamanda Tablo 1 incelendiğinde hem daha genç hem de daha yüksek maaş ve genel olarak memur mevkinde bulunan ortalamasına sahip Kurum B de Kurum A 'ya göre daha yüksek bir maaş memnuniyetsizliği bulunmaktadır. Bu durum bize memurların maaş memnuniyetsizliği üzerine çalışmalar yapılabilceğini gösterir.



Şekil 14 Kurum A (a) ve Kurum B’de (b) çalışan kadınların cinsiyet eşitliği ile ilgili farkındalık artırıcı eğitimler almasına ilişkin görüşlerinin gelir dağılımları

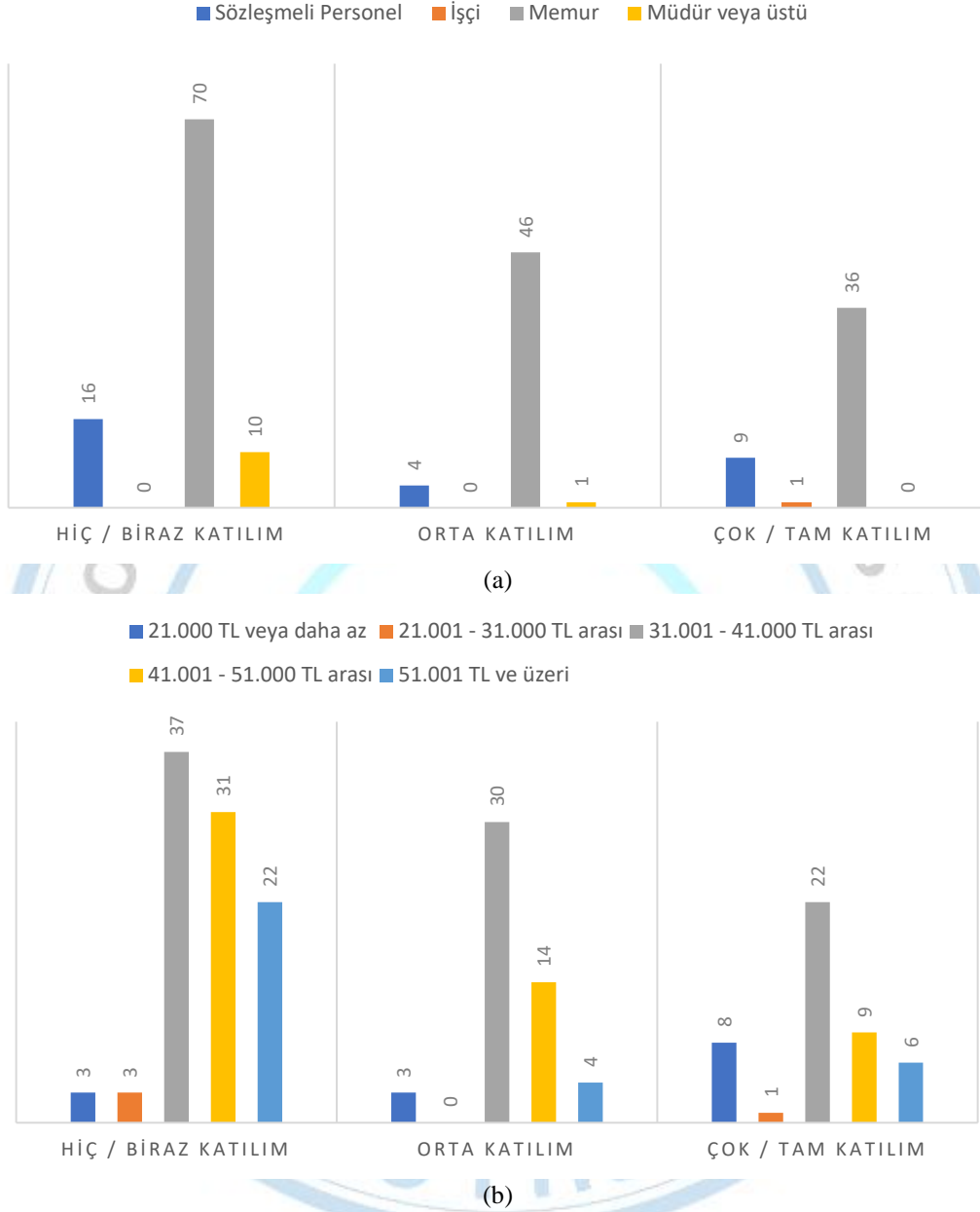
Diğer yandan Tablo 1’de dikkati çeken eğitim alma isteğinin gelir durumuna göre incelenmesi gerektiği düşünülmüştür. Bu bağlamda Şekil 9’da kurumlarda çalışan bu görüşe sahip kadınların gelir dağılımlarına göre karşılaştırılması sunulmuş ve Tablo 2’de bu değişkenler arasındaki ilişkinin varlığı ki-kare ilişki analizi ile incelenmiştir. Buradan elde edilen sonuçlar, kişinin farkındalık artırıcı eğitim alma isteğinin gelir dağılımına göre istatistiksel olarak 0,95 güven düzeyinde anlamlı farklılık gösterdiği görülmektedir.

Tablo 2. Çalışan kadınların farkındalık artırıcı eğitim alma isteği ile gelir dağılımları arasındaki ilişkinin Ki-kare analizi

	Ki-kare değeri	<i>p</i> -değeri
Kurum A	17,453	0,026
Kurum B	22,568	0,004



Benzer şekilde kadınların karşılaşılan zorluklara karşı destek sağlayan kaynaklardan haberdar olması durumu ile çalıştıkları mevkiler arasındaki yapının incelenmesi için ise Şekil 10'da grafik, Tablo 3'te ki-kare analiz sonuçları paylaşılmıştır.



Şekil 10. Kurum A (a) ve Kurum B'de (b) çalışan kadınların karşılaşılan zorluklara karşı destek sağlayan kaynaklardan haberdar olmalarının çalıştıkları mevkiye göre dağılımları.

Şekil 10 ve Tablo 3'teki sonuçlara göre çalışan kadınların karşılaşılan zorluklara karşı destek sağlayan kaynaklardan haberdar olmalarıyla ilişkili görüşlerinin çalıştıkları mevki ile 0,95 güven düzeyinde istatistiksel olarak anlamlı bir ilişkiye sahip olduğu görülmektedir.

Tablo 3. Çalışan kadınların karşılaştıkları zorluklara karşı destek sağlayan kaynaklardan haberdar olmalarının çalıştıkları mevki ile aralarındaki ilişkinin Ki-kare analizi

	Ki-kare değeri	$p$ -değeri
Kurum A	14,635	0,023
Kurum B	20,314	0,009

## SONUÇLAR

Bu çalışmada iki devlet kurumunda çalışan kadınların iş ortamlarından memnuniyetleri anket çalışmasıyla incelenmiş ve karşılaştırılmıştır. Elde edilen sonuçlar incelendiğinde, iki kurum genelinde çalışanların medeni durumu ve çocuk sahibi olma durumları benzerlik göstermektedir. Dikkat çeken farklılıklardan biri; Kurum A’da lise ve daha altı eğitim kurumunda çalışan insan sayısının %13 gibi bir değerle diğer kurumdan epey bir fazla çıkmasıdır. İki kurumdaki maaş ve düzeyleri benzerlik gösterse de Kurum B’deki memur çalışan yüzdesinin %79 çıkması ve Kurum A’da bu gözlemin (müdür veya üstü hariç) yakın dağılması iki kurum arasındaki farkındalığı göstermektedir.

Çalışma bulgularında dikkatimizi çeken bulgulardan bir diğeri ise, kadın çalışanların erkek çalışanlarla eşit fırsatlar sağlanması konusundaki görüşlerin iki tarafta toplanmış olması durumudur. Bu durum kurumların bu konularda farkındalık çalışmaları yapabileceği fikrini güçlendirmektedir. Gelirle ilgili bulgular dikkate alındığında yapılan ki-kare analizleriyle de özellikle gelirle ilgili alanların anlamlı çıkması kişilerin gelir memnuniyeti ile ilgili daha detaylı çalışmalar yapılması ile ilgili ipucu vermektedir. Bu aşamada her ne kadar ülkenin genel ekonomik koşulları belirleyici olsa da bu konunun kadınların çalışma ortamlarından memnuniyet özelinde incelenmesinin kamu politikaları belirleme sürecinde katkı sağlayacağı düşünülmektedir.

## AÇIKLAMA

Çalışmamız 2023 yılı TÜBİTAK–2209-A Üniversite öğrencileri araştırma projeleri desteği programı kapsamında başlamış olup, projemiz hali hazırda devam etmektedir. Aynı zaman da UYİK 5. Uluslararası İstatistik Kongresi 21-23 Mayıs 2024 tarihinde katılım gerçekleştirilip burada sunum yapılmıştır.

## KAYNAKÇA

- Arslan, Y. N. H. ve Güngör, S (2020) ‘Kadının İş Hayatındaki Yeri ve Karşılaştığı Sorunlar Üzerine Nitel Bir Araştırma’ Dergi Park, Cilt 6, Sayı 2
- Bebekoğlu, G. ve Wasti, A. S. (2002). Çalışan Kadınlara Yönelik Cinsiyet Temelli Düşmanca Davranışların Sebepleri ve Sonuçları Üzerine Bir Araştırma, Sabancı Üniversitesi Yönetim Bilimleri Fakültesi. Yönetim Araştırmaları Dergisi, Cilt 2, Sayı 2, Sayfa 215-238
- Kaplan, M. (2011). “Kaplumbağanın Özgürlüğü”: Kadınlar ve Ev İçi Emek, Dergi Park, Cilt 17, Sayı 65, Sayfa 163-172
- Parmelee M. ve Emma C. (2023) Kitap: ‘Kadının İş Hayatındaki Yeri’ yayın tarihi 2023, yayın evi Deloitte
- Takım, G. ve Timuroğlu, K. M. (2006) “Çalışan Memnuyeti ve Algılanan Örgütsel Desteğin Kadın Çalışanların İş-Yaşam Dengesi ve Örgütsel Vatandaşlık Davranışı ile İlişkisi: Tekstil Sektöründe Bir Uygulama” Erzurum Atatürk Üniversitesi Sosyal Bilimler Enstitüsü İşletme Anabilim Dalı Yönetim ve Organizasyon Bilim Dalı Bölümü. İşletme araştırmaları dergisi, Cilt 14, Sayı 4, Sayfa 2956-2971
- Yılmaz, S. (2019). Kadınların iş hayatında karşılaştıkları “Cam Tavan Sendromu” Üzerine Nitel Bir Araştırma (Yüksek Lisans Tezi). İstanbul Sabahattin Zaim Üniversitesi Sosyal Bilimler Enstitüsü. İstanbul, Türkiye.

## EKLER

Anket soruları tablosu;

1)Hangi kurumda çalışmaktasınız?
2)Kaç yaşındasınız?
3)Medeni durumunuz nedir?
4)Çocuğunuz var mı?
5)Herhangi bir kronik rahatsızlığınız var mı?
6)Fiziksel kısıtınız var mı?
7)Son bitirdiğiniz okul nedir?
8)İş yerine giderken hangi ulaşım araçlarını kullanıyorsunuz?
9)Öğlen mesai saatleri içerisinde yemek ihtiyacınızı nasıl karşılıyorsunuz?
10)Gün içinde kaç saat verimli çalıştığınızı düşünüyorsunuz?
11)Kurumdaki mevkiniz nedir?
12)Aylık geliriniz ne kadar?
13)Aylık geliriniz hane bütçesinin ne kadarını oluşturuyor?
14)Aylık kazancınızın yüzde kaçını kişisel harcamalarınıza ayırıyorsunuz?
15)Bakmakla yükümlü olduğunuz insanlar var mı?
15-1) Sorunun cevabı evet var ise; Kaç kişiye bakmakla yükümlüsünüz?

Likert Sorular Tablosu;

16)Fikirlerim erkek iş arkadaşlarımla eşit derecede dikkate alınıyor.
17)İşe başlama tarihinden günümüze maaş artışımı yeterli buluyorum.
18)Kadınların iş hayatında karşılaştığı zorluklara karşı destek sağlayan kaynaklardan haberdarım.
19)Yaşadığım sağlık sorunlarında ihtiyaç halinde çekinmeden izin alabileceğimi düşünüyorum.
20)Çalıştığım kurum cinsiyet eşitliği ile ilgili farkındalık artırıcı eğitimler almamı sağladığını düşünüyorum.
21)İş arkadaşlarınızla veya yöneticilerinizle iş dışı sosyal yaşamımda görüşmekten keyif alırım.
22)Çalıştığım kurum kişisel gelişimimi destekleyecek eğitimler verdiğini düşünüyorum.
23)İş yerimde görevim dışında benden istenen işler olduğunu düşünüyorum.
23-1) Örneğin; çay, içecek istemek, kapıyı kapattırmak gibi.
24)Kadın yöneticiyle çalışmayı tercih ettiğim durumlar oluyor.
25)Çalıştığım kurumda kadınlar için erkek çalışanlar ile eşit fırsatlar sağladığını düşünüyorum.



## Derivation of Linear and Non-linear Models for Estimating the Natural Gas Consumption

**Busra Demir Avci<sup>1\*</sup>, Izzet Karakurt<sup>1</sup>, Gokhan Aydin<sup>1</sup>**

<sup>1</sup>Karadeniz Technical University, Engineering Faculty, Mining Engineering Department,  
Mining&Energy Research Group, 61080, Trabzon, Türkiye

\*Corresponding and presenting author: busrademiravci@ktu.edu.tr

### *Abstract*

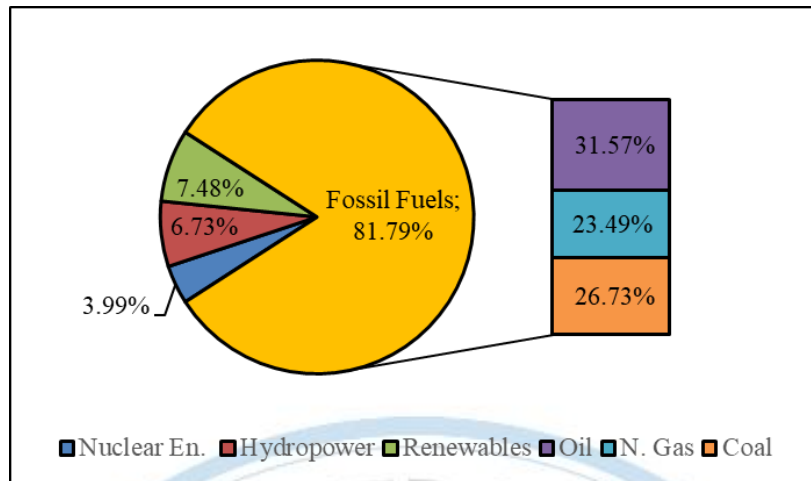
*This paper makes an attempt to demonstrate the usability of trend analysis (TA), for the first time, in order to estimate the natural gas consumption (NGC) of Türkiye and the World. In this framework, NGC and total population (TP) were selected as the dependent and independent variables, respectively. Based on the variables, linear and non-linear predictive models were derived through TA. The derived models were then verified and tested by various statistical indices including the determination coefficient ( $R^2$ ),  $F$  – and  $t$  tests, mean absolute percentage error (MAPE) and relative root mean square error (RRMSE). Accordingly, the future NGC of Türkiye and the World were estimated by the derived models until 2035. The results show that the TA can be effectively applied as a tool for estimating the NGC in both Türkiye and the World.*

**Keywords:** Natural gas consumption, Trend analysis, Estimation, World, Türkiye

### **INTRODUCTION**

Natural gas (NG) is a flexible and plentiful fossil fuel that is essential for supplying energy to a number of industries, including transportation, industrial processes, power generation, and heating. Among the fossil fuels, it is a vital source of energy for lowering pollution and preserving a clean and healthy environment (Aras, 2008; Ma et al., 2023). As reported by EI (2023), in 2022, the NG accounted for roughly 24% of world's energy consumption, just behind the oil and coal, which were responsible for almost 32% and 27% of the world's total energy consumption respectively (Fig.1). The share of the NG in world energy consumption is expected to remain constant in the foreseeable future (Alsobhi, 2015). Despite this projection, it can be argued that there may be fluctuations in NG demand as countries turn to cleaner energy alternatives in order to reduce their dependence on fossil fuels due to their harmful effects on the environment.

NGC can be impacted by a number of factors such as trade agreements or regional conflicts, by altering supply routes and pricing (Ma et al., 2023). Thus, the decision-makers must have accurate NGC forecasts in order to design successful energy policies and make well-informed choices concerning energy infrastructure, environmental laws, and energy security. Additionally, artificial intelligence (AI) forecasting models such as machine learning and grey system, face challenges since they have complex structures especially during the development of the models and applied in real-world scenarios. Simpler and less accurate modeling techniques may, therefore, be more suitable to overcome the relevant challenges. In this regards, this study employs trend analysis (TA) for deriving linear and non-linear population-based predictive models for NGC of both Türkiye and the World total. The TA is less complex than other methods that require more parameters and are significantly more complex. It puts out the notion that readers may predict what's going to occur in the future by examining prior events that have already occurred. In other words; the TA is a branch of study that uses historical data to attempt to forecast future movements (Celiker et al., 2021). The primary focus is on identifying and quantifying patterns that can be represented by lines or surfaces (Kone and Buke, 2010).



**Figure.1.** World primary energy consumption by fuel type in 2022 (EI, 2023)

The rest of the paper is organized as follows. Section 2 presents the data and methodology. Section 3 reveals the results and discussion. And the paper concludes with a synopsis of the key findings and suggestions for additional studies in Section 4, which is titled as conclusions.

## DATA and METHODOLOGY

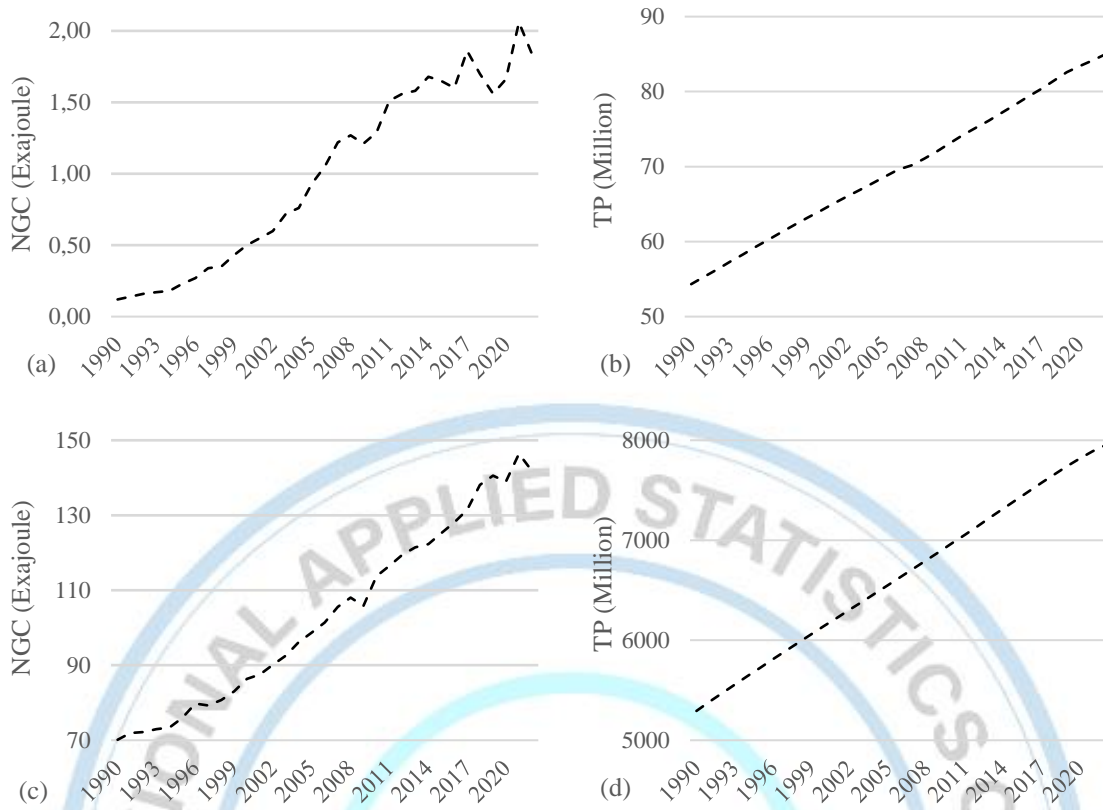
### Data and variable description

This paper uses the data for the NGC and TP from 1990 to 2022 for both Türkiye and the World. The data was gathered from publicly accessible and officially recognized online sources (EI, 2023; WBI, 2024). The TP was chosen as the independent variable because of the strong correlation between it and energy requirements, as well as the ease with which their time series can be found in numerous statistical databases. Additionally, this study's variable selection methodology was based on earlier research investigations of Kavaklıoğlu et al. (2009) and Kankal et al. (2011) since they claim that a range of human activities, including population growth, increase the need for energy resources. Table 1 presents a summary of the variables' descriptive statistics together with the results of the correlation analysis.

**Table 1.** Descriptive statistics and correlation analysis of the variables for both Türkiye and the World

Cases	Variables	Descriptive statistics						Correlations	
		Min	Max	Mean	STD	Skewness	Kurtosis	NGC	TP
Türkiye	NGC	0.12	2.06	0.99	0.63	-0.01	-1.50	1	0.98
	TP	54.320	84.980	69.680	9.23	0.03	-1.15	0.98	1
World	NGC	70.13	146.410	103.52	24.33	0.08	-1.28	1	0.99
	TP	5293.395	7950.940	6642.330	808.94	-0.01	-1.20	0.99	1

Moreover, Figure 2 displays historical Turkish and global NGC and TP trends. It is clearly seen from the Fig.2 that the NGC and TP of Türkiye and the World have been trending increasing over the period from 1990 to 2022.



**Figure.2.** Historical trends for the NGC and TP [(a) the NGC for Türkiye, (b) the TP for Türkiye, (c) the NGC for the World, (d) the TP for the World] (EI, 2023; WBI, 2024)

Furthermore; it is descriptively revealed from Table 1 that the NGC (exajoule) on average are 0.99 and 103.52, while the TP (million) are 69.680 and 6642,330 for Türkiye and the World respectively. As it is clearly seen, the SD of the TP for the World shows the largest deviation. It reflects as 808.94 exhibiting variance. In the same way, the largest average value of the NGC is 103.520 exajoule, belonging to the World again. On the other hand; for an observed series to be considered symmetric or normally distributed, the normal values for kurtosis and skewness must be zero (the ideal one). Nonetheless, some academics contend that the observed series is also comparable to a normal distribution if both values fall within  $\pm 1.5$  (Tabachnick and Fidell, 2013; Erbay and Beydoğlan, 2017). It is evident from Table 1 that every observed series has a normal distribution since their skewness and kurtosis are between  $\pm 1.5$ . Additionally, Table 1 reports that the independent variable (TP) shows a very strong relationship (over 0.95) for the dependent variables (NGC) for both Türkiye and the World. Because of this, it may be concluded that the data mainly supports linearity, one of the core tenets of the regression model put forward by Ostrom (1978).

### Methodology

To estimate the NGCs of Türkiye and the World, the TA was employed in this work to derive and propose estimating models. The research makes the premise that the NGC and TP in the future will follow historical patterns. The main advantage of this strategy is its simplicity, as was also previously noted, and projections are created utilizing the available data. The mathematical illustrations of the equations derived by the TA, are given subsequently.



$$\text{Linear regression model} \quad : y = a + b_t + \varepsilon_t \quad (1)$$

$$\text{Logarithmic regression model} \quad : y = a + \ln(t) + \varepsilon_t \quad (2)$$

$$\text{Power regression model} \quad : y = at^b + \varepsilon_t \quad (3)$$

$$\text{Exponential regression model} \quad : y = ae^{bt} + \varepsilon_t \quad (4)$$

$$\text{Inverse regression model} \quad : y = a + b \left( \frac{1}{t} \right) + \varepsilon_t \quad (5)$$

$$\text{Growth regression model} \quad : y = e^{(a+bt)} + \varepsilon_t \quad (6)$$

$$\text{S regression model} \quad : y = e^{\left[ a + b \left( \frac{1}{t} \right) \right]} + \varepsilon_t \quad (7)$$

where; y is NGC (Exajoule), a is the intercept or the constant, b is the slope, t is the TP (million), and  $\varepsilon_t$  is the difference between actual and predicted values.

A split set of NGC data was used for training and testing purposes. Approximately 85% of the total data was used for training between 1990 and 2017, while the remaining 15% was used for testing between 2018 and 2022. The estimating models were derived using the statistical software SPSS, which has a regression function. The generality, plausibility, and statistical significance of the estimated variables were verified using a range of statistical tests, including the adjusted coefficient of determination ( $\text{adj. } R^2$ ) assessing how well a model fits actual data points, F- and t-tests to verify the existence of significant correlations between the independent and dependent variables and assess the strength of each model coefficient separately, and compare the estimated and actual trends, once the model was derived.

In addition to deriving and validating the models, estimating accuracies of the proposed models were also measured in order to choose the most effective forecasting model. Two statistical indicators as mean absolute percentage error (MAPE) and relative root mean square error (RRMSE) were employed for the estimating accuracies of the proposed models. In general, the fitted curve more closely matches the real data the lower the criteria's value (Paiya et al., 2021). Put otherwise, a falling value of the statistical indices leads to an increase in the accuracy of the forecasting model. The mathematical equations of these two indicators are as follows.

$$MAPE = \frac{1}{n} \sum_{i=1}^n \left( \frac{|EC_{i(\text{predicted})} - EC_{i(\text{actual})}|}{EC_{i(\text{actual})}} \right) \times (100) \quad (8)$$

$$RRMSE = \frac{RMSE}{\bar{o}} \times (100) \quad (9)$$

where; n is the total data points,  $NGC_{i(\text{predicted})}$  is the predicted NGC,  $NGC_{i(\text{actual})}$  is the actual NGC,  $\bar{o}$  is the mean value of actual data.

## RESULTS and DISCUSSION

### Derivation, performance accuracies and verification of the models

Table 2 shows the models that were derived using the TP together with their estimating performance accuracies results. First, models in all equation forms (Eqs. 1-7) were derived for Türkiye and the World. Then, the models with the lowest MAPE and RRMSE values were chosen as the best models.

**Table 2.** Derived models for the NGC of Türkiye and the World

	Equations	MAPE(%)	RRMSE(%)
Türkiye	Linear $y = (-4.107) + (0.073)x$	13.11	11.12
	Logarithmic $y = (-19.667) + \ln(4.884)$	11.80	9.72
	Power $y = (1.04x10^{-14}). (x)^{(7.549)}$	87.67	66.91
	Exponential $= (0.0003). e^{(0.112)x}$	63.67	72.11
	Inverse* $y = (5.655) - (318.634)/x$	8.18	6.95
	Growth $y = e^{[(-8.025)+(0.112)x]}$	111.21	85.31
	S $y = e^{[(7.064) - \frac{500.378}{x}]}$	64.24	48.95
the World	Linear $y = (-86.102) + (0.028)x$	6.04	0.53
	Logarithmic $y = (-1484.378) + \ln(180.424)$	5.91	0.51
	Power* $y = (6.66x10^{-6}). (x)^{(1.879)}$	2.70	0.27
	Exponential $= (14.217). e^{(0.0003)x}$	4.97	0.47
	Inverse $y = (274.685) - (1131646.208)/x$	8.04	0.69
	Growth $y = e^{[(2.654)+(0.0003)x]}$	4.92	0.46
	S $y = e^{[(6.413) - \frac{11832.790}{x}]}$	5.04	0.45

\* indicates the best models since their MAPE and RRMSE indicators are the lowest

In addition, the classification table of the MAPE and RRMSE levels is provided in Table 3. Based on the classification, only one model, inverse function, has the excellent accuracy for Türkiye, while all models have the excellence accuracies for the World. As it is evident from the related Tables that, however, the best model for the world is explained by power function.

**Table 3.** Reference table of the MAPE and RRMSE for the model accuracies (Lewis, 1982; Li et al. 2013)

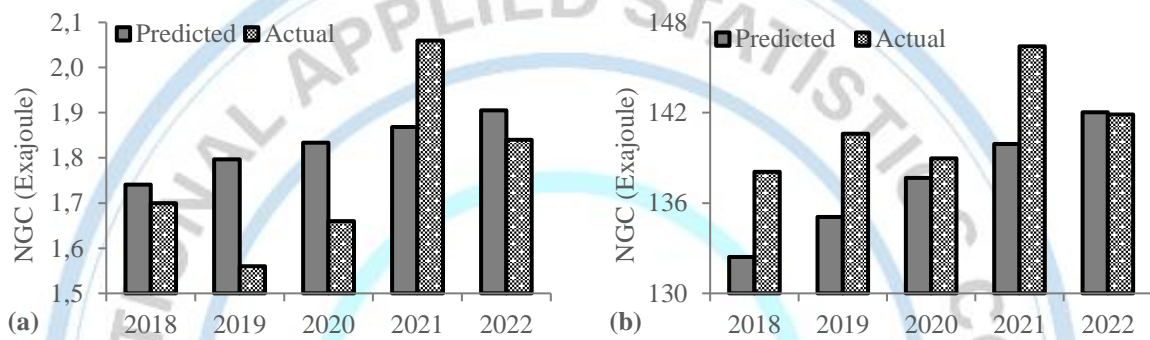
MAPE (%)	RRMSE (%)	Model accuracy
$MAPE \leq 10$	$RRMSE < 10$	Excellent
$11 \leq MAPE \leq 20$	$10 < RRMSE < 20$	Good
$21 \leq MAPE \leq 51$	$20 < RRMSE < 30$	Qualified
$MAPE > 51$	$RRMSE \geq 30$	Unqualified

Based on the verification results in Table 4, the proposed models' adj. R<sup>2</sup> values, which are 0.93 and 0.99 for Türkiye and the World, respectively, show that there is a substantial degree of relationships between the TP and the NGC. Additionally, tabular F – and – t values are significantly smaller than the computed F – and – t values for both models, as Table 4 shows. These results support the statistical significance of the variables and models at a 95% confidence level.

**Table 4.** Verification results of the derived models

	Independent variables	Std. error of est.	$t_{\text{calculated}}$	$t_{\text{table}}$	$F_{\text{calculated}}$	$F_{\text{table}}$	Adj.R <sup>2</sup>
<b>Türkiye</b>	Constant	0.156	21.911	1.690	350.530	4.125	0.93
	TP (million)		-18.722				
<b>the World</b>	Constant	0.097	2.697	1.690	1974.095	4.125	0.99
	TP (million)		44.431				

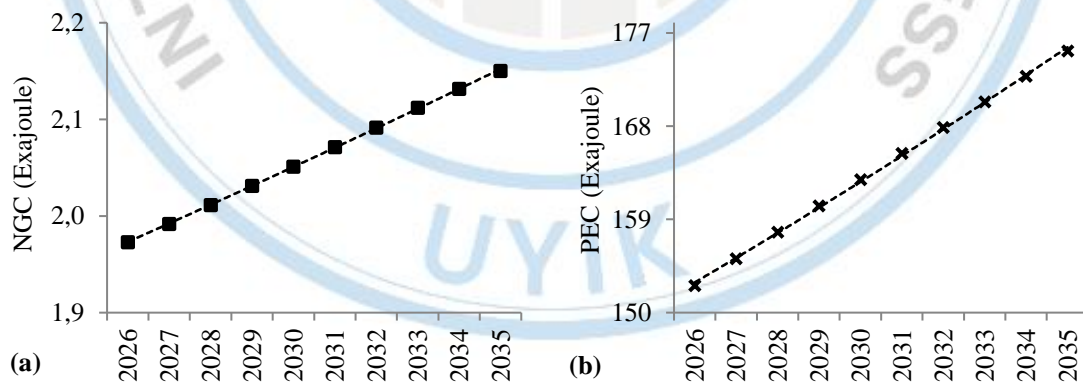
Moreover, if we look at the predicted versus the actual trends of the NGC, as shown in Fig.3, one may argue that there is a significant correlation between the predicted and actual NGCs. In other words; the related Figure proves that the derived models are capable of producing accurate NGC estimates. The verification results, in the end, show that two models have statistical significance.



**Figure 3.** Predicted vs actual NGC [(a) : Türkiye, (b) the World]

#### A ten-year estimation of the NGCs

Figure 4 illustrates the estimating results of the future NGCs for Turkey and the World between 2026 and 2035 using the United Nations' projected data on the TP (UN, 2018).



**Figure 4.** Estimating results for the NGCs [(a) : Türkiye, (b) the World]

In comparison to data in 2022, Fig. 4 makes it clear that Turkish and the World's NGCs will climb to 2.15 and 175.27 exajoules in 2035, representing a total 16.86% and 23.53% increase rates respectively. In other words; an average annual growth of 1.07% and 1.78% is expected for the NGCs of Türkiye and the World respectively.



## CONCLUSIONS

The following summarizes the main findings of this paper, which employed the TA to derive estimating models for the NGCs of Türkiye and the World using the TP as the independent variable.

- It was discovered that the models, derived for Türkiye were defined by linear, logarithmic and inverse functions, while those derived for the World were explained by all types of the functions.
- It was seen that only one model, inverse function, gives the excellent estimating accuracy for Türkiye, whereas all models show the excellent estimating accuracies for the World on the basis of their statistical error indicators. It was also determined that linear and logarithmic models for Türkiye have good estimating accuracies.
- It was projected that the NGCs of Türkiye and the World will increase over ten years at the rates of almost 17% and 24% respectively, annually 1.07% and 1.78%.
- It was revealed that the TA can be effectively used to derive models for the estimation of the NGC. In order to generalize the results, therefore, it is highly recommended that estimating models may be derived by the TA, taking into account a variety of variables, such as gross domestic products (GDP) and urban population (UP) for various countries and regions, in addition to Türkiye and the World total.

## References

- Alsobhi S, 2015. Modeling and optimization of natural gas processing and production networks. PhD. Thesis, Chemical Engineering, Waterloo, Ontario, Canada.
- Aras N, 2008. Forecasting residential consumption of natural gas using genetic algorithms. *Energy Exploration & Exploitation*, 26(4): 241-266. <https://doi.org/10.1260/014459808787548705>
- Celiker M, Yukseler U, Dursun OF, 2021. Trend analyses for discharge-recharge of Tacin karstic spring (Kayseri, Turkey). *Journal of African Earth Sciences* 184: 104344. <https://doi.org/10.1016/j.jafrearsci.2021.104344>
- EI, 2023. Statistical review of world energy 2022, published by Energy Institute. <https://www.bp.com/en/global/corporate/energy-economics/statistical-review-of-world-energy.html>; Date of access: 20.12.2023.
- Erbay S, Beydoğan HO, 2017. Attitudes of educators towards educational research. *Ahi Evran University, Kırşehir Journal of the Faculty of Education*, 18(3):246-260.
- Kankal M, Akpınar A, Komurcu IM, Ozsahin ST, 2011. Modeling and forecasting of Turkey's energy consumption using socio-economic and demographic variables. *Applied Energy*, 88(5):1927-1939. <https://doi.org/10.1016/j.apenergy.2010.12.005>
- Kavaklıoğlu K, Ceylan H, Ozturk KH, Canyurt EO, 2009. Modeling and prediction of Turkey's electricity consumption using artificial neural networks. *Energy Conversion and Management*, 50(11):2719-2727. <https://doi.org/10.1016/j.enconman.2009.06.016>
- Kone AC, Buke T, 2010. Forecasting of CO<sub>2</sub> emissions from fuel combustion using trend analysis. *Renewable and Sustainable Energy Reviews* 14(9):2906-2915. <https://doi.org/10.1016/j.rser.2010.06.006>
- Lewis CD, 1982. *International and business forecasting methods*. Butterworth-Heinemann, 143 pages, London.
- Li MF, Tang XP, Wu W, Liu HB, 2013. General models for estimating daily global solar radiation for different solar radiation zones in mainland China. *Energy Conversion and Management*, 70:139-48. <http://dx.doi.org/10.1016/j.enconman.2013.03.004>.
- Ma X, Deng Y, Yuan H, 2023. Forecasting the natural gas supply and consumption in China using a novel grey wavelet support vector regressor. *Systems*, 11(8):428. <https://doi.org/10.3390/systems11080428>
- Ostrom CW, 1978. *Time series analysis (Sage University papers series on quantitative applications in the social sciences, series no. 07-009)*. Thousand Oaks, CA: Sage.

- Paiva H, Afonso RJM, Caldeira FMSLA, Velasquez EA, 2021. A computational tool for trend analysis and forecast of the COVID-19 pandemic. *Applied Soft Computing*, 105:107289. <https://doi.org/10.1016/j.asoc.2021.107289>
- Tabachnick BG, Fidell LS, 2013. Using multivariate statistics. Half-Price Hank's Books Fulfilled by Amazon, 7th. Edition, Boston, the USA.
- UN, 2018. United Nations, Department of Economic and Social Affairs, Population Division, World Urbanization Prospects: The 2018 Revision, Online Edition. <https://population.un.org/wup/Download/>; Date of access: 20.04.2024
- WBI, 2024. Worldbank indicators on urban population, <https://data.worldbank.org/indicator/SP.URB.TOTL.IN.ZS>; Date of access: 05.05.2024

#### **Acknowledgment**

The authors declare that the study received no support.

#### **Conflict of Interest**

The authors have declared that there is no conflict of interest.

#### **Author Contributions**

**Busra Demir Avci:** Investigation, Data curation, Software, Validation. **Izzet Karakurt:** Conceptualization, Methodology, Writing Original-draft preparation. **Gokhan Aydin:** Visualization, Reviewing and Editing.



## Regression Analysis as a Simple Approach for Developing Models to Forecast the Coal Consumption

**Busra Demir Avcı<sup>1\*</sup>, Izzet Karakurt<sup>1</sup>, Gokhan Aydin<sup>1</sup>**

<sup>1</sup> Karadeniz Technical University, Engineering Faculty, Mining Engineering Department,  
Mining&Energy Research Group, 61080, Trabzon, Türkiye

\*Corresponding and presenting author: busrademiravci@ktu.edu.tr

### *Abstract*

*It is fact that the majority of artificial intelligence-based computing techniques have the benefits of precisely representing long-term trends phenomenon. However, they have certain drawbacks (e.g. black box in it) in the development of the models and applied in real-world scenarios due to their complex structures. Simpler and less accurate modeling strategies may be, therefore, more suitable to overcome the relevant challenges. Regression analysis (RA) is less complex than other methods that require more parameters and are significantly more complex. Hence, the RA was used as a tool to forecast the coal consumption (CC) of both Türkiye and world in this study. While total population (TP), urban population (UP) and gross domestic product (GDP) were selected as independent variables in the study, CC was selected as the dependent variable. Additionally, the developed models were statistically validated and the forecasting performances were measured using several metrics. Moreover, the most significant variables affecting the CC were statistically determined. Furthermore, the future CC of Türkiye and world were forecasted by the proposed models from the period of 2025 – 2030.*

**Keywords:** Coal consumption, Regression analysis, Forecast, World, Türkiye

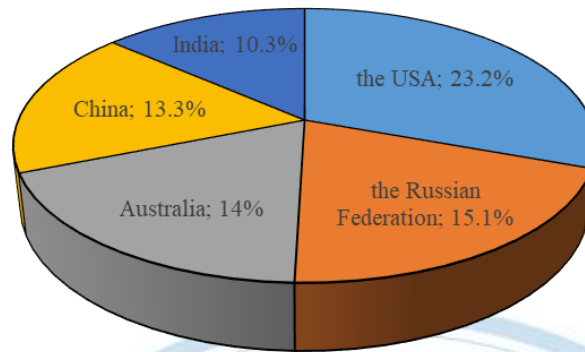
### **INTRODUCTION**

Energy has become essential for both the development of the global economy and our civilization in the twenty-first century. Even though there have been enormous technological developments worldwide, the primary energy source in the world is still fossil fuels (FFs), which include coal, natural gas, and oil (Benalcazar et., 2017). As reported by IEA (2021), more than 75% of the world's energy consumption will still come from the FFs in the foreseeable future.

Coal's abundance, affordability and reliability have made it an important part of the world energy mix among the FFs. With the five largest countries holding 76% of the world's coal reserves as shown in Fig.1., economically producible coal reserves are projected to last around 130 years at the current production level. This is a significantly longer period of time than the projected 53 and 51 years for the natural gas oil respectively (IEA, 2021; EI, 2023). Despite the major benefits such as the primary source of raw materials for thermal power plants, coal contributes also significantly health issues and environmental pollution since the process of conversion and utilization results in the large-scale emission of harmful air pollutants, primarily CO<sub>2</sub> and SO<sub>2</sub> (Irfan et al., 2020). Therefore, a number of comprehensive energy-saving and emission-reduction programs, increased attempts to control coal demands and consumption, and more stringent carbon dioxide emission reduction objectives is required for countries that heavily rely on the coal. Given these facts, it is crucial to establish and carry out appropriate development strategies and plans that align with the overall and long term balance of coal supply and demand or coal production/consumption. Actually, the primese for developing development strategies and plans is to produce an as accurate a forecast as possible for the future trend of coal. In this way, the coal market may be stabilized, the coal industry's efficiency may be raised, the financial



performance of coal-related businesses may be guaranteed, and precautions against potential environmental effects may be taken



**Figure 1.** The five largest countries holding 76% of the world's coal reserves (EI, 2023)

In addition to other energy sources, many scholars have been developing and utilizing a variety of techniques or approaches, ranging from econometric to artificial intelligence (AI)-based methods, in terms of forecasting coal consumption (CC) in recent years. Unfortunately, because each model has advantages and disadvantages of its own, it is challenging for one model to provide best performance in every situation. Additionally, owing to their complex structures, artificial intelligence-based forecasting models such as machine learning and grey systems also present some challenges in both the development process and real-world implementation. In such cases, less sophisticated and more straightforward modeling/forecasting methods might be more appropriate for resolving the issues at hand as reported by Bianco et al. (2014). Regression analysis (RA) is a commonly employed statistical technique in numerous study fields for forecasting the correlations between distinct sets of variables among the forecasting techniques in the existing literature (Aydin et al., 2013; Yazar et al., 2017). It has the following advantages over other forecasting techniques, but is not limited to. First, regression toolboxes are included in practically almost all statistical software packages, making model deriving simple. Second, the derived model is more comprehensible and straightforward because the dependent variable is expressed as a function of the independent variables. Third, unlike the AI-based techniques, it doesn't have any black box features that would obscure the structure of the function being approximated while deriving a model. Fourth, once the final formula has been determined, it can be employed for any forecast or scenario (Sen et al., 2016).

Based on the explanations above, this paper employs the RA as a simple approach for developing models to forecast the (CC). In the study, the total population (TP), urban population (UP) and gross domestic products (GDP) are used as the independent variables, while the CC is the dependent variable. In addition, Türkiye and World total are selected as the cases for the study. And, the rest of the paper is organized around four sections. Just behind the Section 1, which includes the introduction, Section 2 presents the data and methodology. Results of the study is reported and discussed in Section 3. The paper is finalized with the section 4, summarizing the key findings of the paper together with the recommendations for future studies.

## DATA and METHODOLOGY

### Data description and descriptive statistics

As was previously stated, in the current study, the CC was selected as the dependent variable and the TP, UP, and GDP were selected as the independent variables. This was done since the time series for these variables are readily available in numerous statistical databases and they have a strong link with

**V. International Applied Statistics Congress (UYIK - 2024)**  
**Istanbul / Turkey, May 21-23, 2024**

energy demands. Additionally, previous research studies of Kavaklıoğlu et al. (2009) and Kankal et al. (2011) served as the foundation for the variable selection process in this study. The data spanning from 1980 to 2022, was obtained from officially recognized and publically available web sources for both Türkiye and the World (EI, 2023; WBI, 2024). Table 1 and Table 2 display the results for the descriptive statistics and correlation analysis of the variables respectively.

**Table 1.** Descriptive statistics of the variables for both Türkiye and the World

Cases	Variables	Descriptive statistics					
		Min	Max	Mean	STD	Skewness	Kurtosis
Türkiye	CC	0.290	1.650	0.893	0.390	0.394	-0.866
	TP	44.089	80.312	62.349	10.738	-0.049	-1.149
	UP	19.302	59.948	40.034	11.745	-0.061	-1.035
	GDP	59.937	957.799	373.402	317.476	0.714	-1.158
the World	CC	75.090	161.490	112.584	29.655	0.547	-1.361
	TP	4442.348	7576.441	6007.345	940.433	-0.015	-1.185
	UP	1746.581	4146.102	2839.832	720.085	0.212	-1.146
	GDP	11495.788	81484.101	39683.364	23327.966	0.545	-1.099

**Table 2.** Results for the correlation analysis of the variables for both Türkiye and the World

Cases	Variables	CC	TP	UP	GDP
Türkiye	CC	1	0.97	0.97	0.96
	TP	0.97	1	0.99	0.92
	UP	0.97	0.99	1	0.92
	GDP	0.96	0.92	0.92	1
the World	CC	1	0.94	0.96	0.98
	TP	0.94	1	0.99	0.98
	UP	0.96	0.99	1	0.98
	GDP	0.98	0.97	0.98	1

Table 1 indicates that the average GDP (current US dollars) for Türkiye and the World are 373.402 and 39683.364, respectively. These values are fairly large, with standard deviations of 317.476 and 23327.966 showing the most associated variation. The GDP are followed by the UP, TP and CC for Türkiye and the TP, UP and CC for the World. An observed series is considered normally distributed or symmetric when its skewness and kurtosis normal values are zero, which is the ideal value. Nonetheless, some academics contend that the observed series is also comparable to a normal distribution if both values fall within  $\pm 1.5$  (Tabachnick and Fidell, 2013; Erbay et al., 2017). In light of the skewness and kurtosis of Table 1's results, it may be concluded that every observed series flows normally. As a result, it can be said that the data largely supports linearity, which is one of the fundamental presumptions made by Ostrom (1978) for the regression analysis. In addition, in the correlation matrix, a bivariate correlation technique was applied to the original data set as well. According to the bivariate correlation analysis in Table 2, it can be disclosed that the independent variables have higher correlations with the dependent variable (CC).

## Methodology

Two categories were created out of the annual data for the variables: one for training the model between 1980 and 2017 and another for testing the model between 2018 and 2022. The models were derived using the SPSS statistics package program's multiple regression (MLR) module. To find the optimal model, the backward MLR analysis method was applied. This approach includes all independent variables in the model deriving process from the beginning. Subsequently, the process of deriving the model proceeds step-by-step, with each variable being eliminated based on its partial F value. When a discarded variable has a strong statistical contribution, the process is terminated and the model is built.

A variety of statistical tests were used to confirm the models' goodness-of-fit and the statistical significance of the estimated variables once they had been established. One measure of how well a curve or model fits the data is the adjusted coefficient of determination (adj.  $R^2$ ). Second is the F-test, confirming the meaningful relationships between the independent and dependent variables. Third is the t-test, which evaluates the power of each of the model's individual coefficients. To assess the significance of the model, the plots of the actual and predicted data were also examined. In addition to confirmation tests, in order to show the forecasting accuracies and effectiveness of the proposed models, the mean absolute percentage error (MAPE), whose mathematical expression is described below, was adopted in the study as well.

$$MAPE (\%) = \frac{1}{n} \sum_{i=1}^n \left( \frac{|e_i|}{y_i} \right) \cdot 100 \quad [1]$$

where,  $n$  is the total number of measurements,  $e_i$  is the differences between actual and predicted value and  $y_i$  is the actual value.

Because of its benefits of scale independence and interpretability, Kim and Kim (2016) describes the MAPE as one of the most commonly used metrics of forecast accuracy. The MAPE is well-liked by industry practitioners due to its scale independence and ease of interpretation (Azadeh et al., 2010). Because it presents the error as a percentage, this measure is simple to interpret. Thus, in the paper, the MAPE was employed for measuring the forecastin accuracies of the derived models.

## RESULTS and DISCUSSION

### Development of the models

The following are the developed regression models that may be used to forecast the CCs of Türkiye and the World after the determining the adequacies of the data for the modeling was determined. It may be inferred that Türkiye's and the World's CC is represented as a linear function of multiple independent variables. Because it offers an assessment of the variables' relative importance in predicting the dependent variable (Aydin et al., 2013; Karakurt et al., 2013), the contribution rates for the independent variables in the regression models were also statistically determined in this stage. With statistical determinations of 51.56% and 82.31%, respectively, the UP was found to be the most significant independent variable for Türkiye, while the GDP was the most significant independent variable for the world.

$$CC_T = (2.049) - (0.082).TP + (0.095).UP + (0.001).GDP \quad [2]$$

$$CC_W = (81.031) - (0.011).UP + (0.002).GDP \quad [3]$$



where;  $CC$  is the coal consumption (Exajoule),  $TP$  is the total population (Million),  $UP$  is the urban population (Million) and  $GDP$  is the gross domestic product (current US\$),  $T$  and  $W$  are Türkiye and the World respectively.

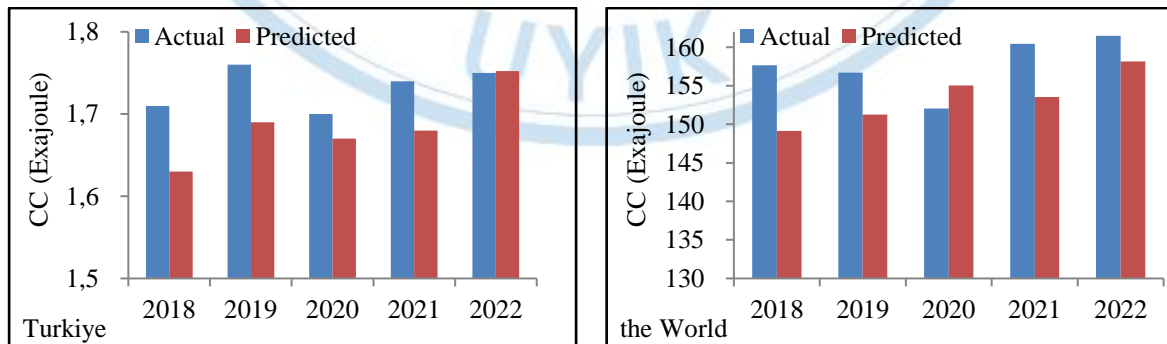
### Verification of the developed models

The statistical results of the RA overall are shown in Table 3. As can be observed, the developed models' adj.  $R^2$  values are 0.97. This indicates that the equations account for at least 97% of the variation in the real data. In other words; the adj.  $R^2$  values show a strong correlation between the  $TP$ ,  $UP$ ,  $GDP$ , and  $CC$ s. It is important to remember that greater  $R^2$  values do not imply that the models are true, as the  $R^2$  only indicates how strongly actual and predicted values are linearly related. As a result, in order for the verification to be approved, further testing must be done as follows.

**Table 3.** Statistical results of the developed models for both Türkiye and the World

Cases	Variable	Coefficients	$t_{computed}$	$t_{table}$	$F_{computed}$	$F_{table}$	$R^2$
Türkiye	Constant	2.049	2.878	1.677	443.466	2.855	0.97
	TP (million)	-0.082	-3.015				
	UP (million)	0.095	3.796				
	GDP (current US\$)	0.001	5.967				
the World	Constant	81.031	7.789	1.677	568.737	2.855	0.97
	UP (million)	-0.011	-1.760				
	GDP (current US\$)	0.002	8.191				

If the computed t-and F-values are greater than those in tabulated, the variables and whole models are respectively considered to be significant. It is evident from Table 3, one can understand that the calculated t-values of all variables involved in the models and the computed F-ratios of all models are greater than the tabulated t-value and F-ratio, confirming the correctness of the models. On the other hand, the generality and plausibility of the models were further studied by examining the predicted trends with respect to the actual trends as shown in Fig.2. It can be generally concluded from the figures that there is a high degree of relationship between the predicted and actual  $CC$ s. As a whole, the figures indicate that the developed models can give adequate predictions for the  $CC$ s for the conditions considered in the study. In other words, these results show that the related models are statistically significant and that the  $CC$ s of Türkiye and the World may be modelled in this way.



**Figure 2.** Predicted vs actual  $CC$ s for Türkiye and the World

### Forecasting performances of the proposed models

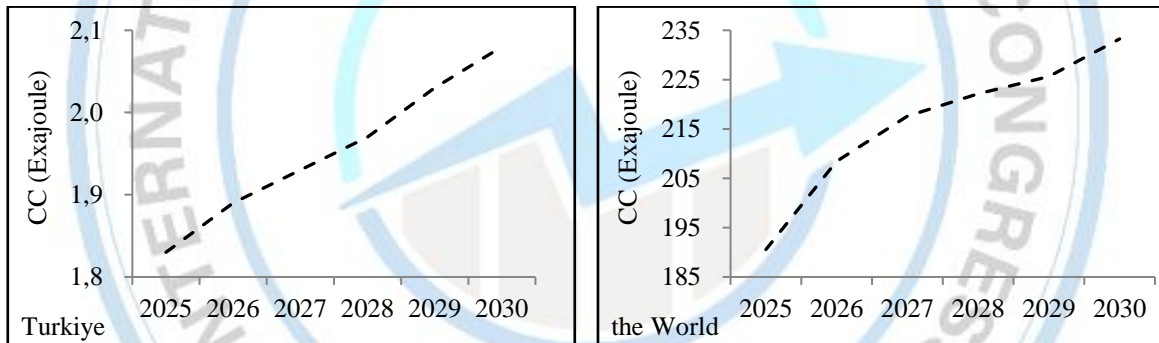
As previously mentioned, the forecasting performances of the suggested models were evaluated using the equation [1]. The MAPE values of Türkiye and the World were found as 2.80% and 3.44% respectively. That means, the suggested models give the excellent accuracies for forecasting the CCs since their MAPE values are less than 10% as indicated by the criteria, which is presented in Table 4.

**Table 4.** Reference table of the MAPE for the model accuracies (Lewis, 1982)

MAPE (%)	Model accuracy
$MAPE \leq 10$	Excellent
$11 \leq MAPE \leq 20$	Good
$21 \leq MAPE \leq 51$	Qualified
$MAPE > 51$	Unqualified

### Forecasting the future CCs through the proposed models

Based on the projected data on the independent variables by UN (2018) and OECD (2024), the CCs of Türkiye and the World are forecasted for the period of 2025-2030 with the proposed models. The results show obviously that significant increases are expected for the CCs of Türkiye and the World for the foreseeable future (Fig.3).



**Figure 3.** Projections for the CCs in Türkiye and the World

In other words; the total CCs of Türkiye will reach to a level from 1.75 exajoule in 2022 to 2.08 exajoule in 2030, a total increase of 18.86%. In case of the World, it is projected that the CC of the World will rise from 161.47 exajoule in 2022 to 233.25 exajoule in 2030, an increase rate of almost 45%.

### CONCLUDING REMARKS

This study used RA as a simple approach among many forecasting tools to estimate the CCs of Turkey and the World, taking into account independent variables such as TP, UP and GDP. It was determined that the CC of Türkiye can be forecasted by the model which includes the TP, UP and GDP, while the CC of the World can be forecasted by the model that the UP and GDP involve. It was also statistically found that both developed models have passed the verification tests successfully. Additionally, the UP and GDP were found to be the most significant independent variables for Türkiye and the World respectively. Moreover, it was revealed that the developed models will be able to forecast the CCs of Türkiye and the World up to 97% accurate, based on their error indicators. Furthermore, it was recorded that an increase rate of almost 19% and 45% is projected for the CCs of Türkiye and the World in the near future. Finally, the current paper concluded that the RA is capable of developing predictive models

for the CCs effectively. In conclusion, in order to generalize the results, more studies required in the relevant area. In these studies, thus, different indicators and/or variables could be taken into consideration and the models should be developed by the RA, in addition to Türkiye and other countries that heavily rely on coal for their energy needs.

## References

- Aydin G, Karakurt I, Aydiner K. 2013. Investigation of the surface roughness of rocks sawn by diamond sawblades. *International Journal of Rock Mechanics and Mining Sciences*, 61:171-182. <https://doi.org/10.1016/j.ijrmms.2013.03.002>
- Azadeh A, Saberi M, Ghorbani S. 2010. An ANFIS algorithm for improved forecasting of oil consumption: A case study of USA, Russia, India and Brazil. *Journal of Scientific & Industrial Research*, 69(3):194-203.
- Benalcazar P, Krawczyk M, Kaminski J. 2017. Forecasting global coal consumption: An artificial neural network approach. *Mineral Resources Management*, 33(4):29-44. <https://doi.org/10.1515/gospo-2017-0042>
- Bianco V, Scarpa F, Tagliafico LA. 2014 Analysis and future outlook of natural gas consumption in the Italian residential sector. *Energy Conversion and Management*, 87:754-764. <https://doi.org/10.1016/j.enconman.2014.07.081>
- EI, 2023. Statistical review of world energy 2022, published by Energy Institute. <https://www.bp.com/en/global/corporate/energy-economics/statistical-review-of-world-energy.html>; Date of access: 20.12.2023.
- Erbay S, Beydoğan HO. 2017. Attitudes of educators towards educational research. *Ahi Evran University, Kirsehir Journal of the Faculty of Education*, 18(3):246-260.
- IEA, 2021. World energy outlook 2021. <https://www.iea.org/reports/world-energy-outlook-2021>; Accessed on 20th. April 2023.
- Irfan M, Hao Y, Panjwani MK, Khan D, Chandio AA, Li H. 2020. Competitive assessment of south asia's wind power industry: SWOT analysis and value chain combined model. *Energy Strategy Reviews*, 32:100540. <https://doi.org/10.1016/j.esr.2020.100540>
- Kankal M, Akpınar A, Komurcu IM, Ozsahin ST, 2011. Modeling and forecasting of Turkey's energy consumption using socio-economic and demographic variables. *Applied Energy*, 88(5):1927-1939. <https://doi.org/10.1016/j.apenergy.2010.12.005>
- Karakurt I, Aydin G, Aydiner K. 2013. Experimental and statistical analysis of cutting force acting on diamond sawblade in sawing of granitic rocks. *Proceedings of The Institution of Mechanical Engineers Part B-Journal of Engineering Manufacture*, 2013:227(2):286-300. <https://doi.org/10.1177/0954405412460971>
- Kavaklıoğlu K, Ceylan H, Ozturk KH, Canyurt EO, 2009. Modeling and prediction of Turkey's electricity consumption using artificial neural networks. *Energy Conversion and Management*, 50(11):2719-2727. <https://doi.org/10.1016/j.enconman.2009.06.016>
- Kim S, Kim H. 2016. A new metric of absolute percentage error for intermittent demand forecasts. *International Journal of Forecasting*, 32:669-679. <https://doi.org/10.1016/j.ijforecast.2015.12.003>
- Lewis CD, 1982. *International and business forecasting methods*. Butterworth-Heinemann, 143 pages, London.
- OECD, 2024. OECD Data. <https://data.oecd.org>; Accessed on 12 May 2024.
- Ostrom CW, 1978. *Time series analysis (Sage University papers series on quantitative applications in the social sciences, series no. 07-009)*. Thousand Oaks, CA: Sage.
- Sen P, Roy M, Pal P. 2016. Application of ARIMA for forecasting energy consumption and GHG emission: A case study of an Indian pig iron manufacturing organization. *Energy*, 116(Part 1):1031-1038. <https://doi.org/10.1016/j.energy.2016.10.068>
- Tabachnick B, G, Fidell LS. 2013. *Using multivariate statistics*. Boston, Pearson
- UN, 2018. United Nations, Department of Economic and Social Affairs, Population Division 2018. *World Urbanization Prospects: The 2018 Revision, Online Edition*.



WBI, 2024. Worldbank indicators on urban population, <https://data.worldbank.org/indicator/SP.URB.TOTL.IN.ZS>; Date of access: 05.05.2024  
Yazar I, Yavuz HS, Yavuz AA. 2017. Comparison of various regression models for predicting compressor and turbine performance parameters. Energy, 140:1398-1406. <https://doi.org/10.1016/j.energy.2017.05.061>

#### **Acknowledgment**

The authors declare that the study received no support.

#### **Conflict of Interest**

The authors have declared that there is no conflict of interest.

#### **Author Contributions**

**Busra Demir Avci:** Investigation, Data curation, Software, Validation. **Izzet Karakurt:** Conceptualization, Methodology, Writing Original-draft preparation. **Gokhan Aydin:** Visualization, Reviewing and Editing.



## Evaluating the Effectiveness of Occupational Safety and Ergonomics Inspections in Türkiye's Mining, Construction, and Metal Industries with an Integrated MCDM Model

Sura Toptancı<sup>1\*</sup>, Çağlar Karamaşa<sup>2</sup>

<sup>1</sup> Eskişehir Technical University, Faculty of Engineering, Department of Industrial Engineering, 26555, Eskişehir, Türkiye

<sup>2</sup> Anadolu University, Faculty of Business, Department of Business Administration, 26470, Eskişehir, Türkiye

\*Corresponding author e-mail: sani@eskisehir.edu.tr

### Abstract

*Occupational safety and ergonomics (OSE) inspections are of critical importance as they contribute to many issues such as preventing the occurrence of undesired events, protecting the health and safety of workers, ensuring that workplaces operate in accordance with legal regulations, raising awareness and training employers and workers, improving the work environment, and ensuring the sustainability of OSE. In Türkiye, these inspections are conducted by the Ministry of Labour and Social Security's Labor Inspection Board in the types of " scheduled" and " unscheduled" inspections. However, the regularity and effectiveness of these inspections are a matter of ongoing debate in Türkiye, particularly due to major occupational accidents in the mining, construction, and metal industries. Therefore, identifying the annual course of inspections by industry and establishing their regularity and effectiveness will contribute to the correct formulation of OSE targets and associated strategies, and to making the right decisions in this regard. This study aims to evaluate the effectiveness of OSE inspections in the mining, construction, and metal industries, which have the highest number of fatal occupational accidents, with an integrated Multi-Criteria Decision-Making (MCDM) model yearly. Accordingly, the year-based OSE inspection performances of each industry were determined by considering the rate of non-fatal occupational accidents, the rate of occupational diseases, the rate of fatal occupational accidents, the rate of inspections by the number of workers, the number of scheduled inspections and the number of unscheduled inspections. In the study, labour statistics published by the Ministry of Labor and Social Security and occupational accidents and workplace statistics published by the Social Security Institution were used for the years 2013-2022. The LOPCOW and WENSLO methods were used to determine the weights of the evaluation criteria and the ERUNS method was used to rank the OSE performance levels of the concerned industries yearly. The results obtained are not subjective and more precise since all three MCDM methods are objective approaches that are applied without the influence of the decision-maker. The results revealed the need to plan more effective and comprehensive OSE inspection programs. This is the first study to examine the effectiveness of OSE inspections using innovative analytical decision tools.*

**Keywords:** Ergonomics, Occupational safety, Multi-Criteria Decision-Making (MCDM), Inspections.

### INTRODUCTION

Occupational safety and ergonomics (OSE) inspections play a significant role in preventing the occurrence of undesired events, protecting the health and safety of workers, ensuring that workplaces operate under legal regulations, raising awareness and training employers and workers, improving the work environment, and ensuring the sustainability of OSE. In Türkiye, the OSE inspections are conducted by the Ministry of Labour and Social Security's Labor Inspection Board in the types of

"scheduled" and "unscheduled" inspections. However, the regularity and effectiveness of these inspections have been a matter of debate for a long time in Türkiye (Yılmaz, 2015).

In the world and in general, the relationship between OSE inspections and the number of occupational accidents has been the subject of many studies. According to the results of these studies, it has been concluded that safety-related inspections reduce injuries in the long term. On the other hand, in Türkiye, few studies examine the legal aspects of labor inspections. Yılmaz (2015) evaluated the number and rates of inspections based on the number of employees and insured persons in some sectors using data from 2012-2013. Çalış and Çalış (2022) examined the number of inspections by group presidencies, administrative fines, number of occupational accidents, and number of fatal accidents. In their study, Dinkçi and Akpınar (2023) evaluated the number of workplaces inspected, administrative fine amount, number of workers inspected, and number of employers imposed administrative fines using data for 2021. These studies have only used descriptive statistical approaches and they do not measure the OSE inspection performance and effectiveness for different industries considering the annual trend. However, determining the annual inspection pattern of the industries and demonstrating their regularity and effectiveness with analytical and systematic tools is so important since they contribute to many issues such as ensuring OSE targets and related strategies are formulated correctly and that the right decisions are taken in this regard.

The assessment of OSE inspection performances is essentially a decision-making problem that involves evaluating and ranking alternatives based on predefined criteria. To solve such decision problems, the literature often employs Multiple-Criteria Decision-Making (MCDM) methods. However, to the best of our knowledge, there are no other studies that have examined the effectiveness of OSE inspections in industries using MCDM methods in the literature.

This study aims to annually evaluate the performances of OSE inspections in the construction, mining, and metal sectors, which are very hazardous industries, with an integrated MCDM model. Accordingly, the OSE inspection performances of each industry are determined yearly by taking into account many different evaluation criteria. In the integrated model, the LOGarithmic Percentage Change-driven Objective Weighting (LOPCOW) and Weights by ENvelope and SLOpe (WENSLO) methods are used to determine the weights of the evaluation criteria and the Evaluation based on Relative Utility and Nonlinear Standardization (ERUNS) method is used to rank the OSE inspection performance levels of the concerned industries yearly. The results obtained are not subjective and more precise since the proposed MCDM approaches are objective techniques applied without the effect of the decision-makers. This study makes a significant contribution to the literature on ergonomics and occupational safety, taking into account the gaps in the literature and the deficiencies identified in the studies conducted on OSE inspections.

## **MATERIAL AND METHODS**

### **Material**

The data used in this study are obtained by compiling the statistical information provided in the "Labour Statistics" for the years 2013-2022 published by the Ministry of Labour and Social Security and the "Work Accidents and Occupational Diseases Statistics" and "Insured and Workplace Statistics" of the Social Security Institution for the years 2013-2022. The evaluation criteria for assessing the adequacy and effectiveness of OSE inspections are determined based on a literature review. Table 1 shows the evaluation criteria and alternatives considered in this study. The evaluation criteria are categorized as cost and benefit criteria depending on the optimization direction. Besides, the years 2013 to 2022 are defined as alternatives to be ranked in the study.



**V. International Applied Statistics Congress (UYIK - 2024)**  
**Istanbul / Turkey, May 21-23, 2024**

**Table 1.** Evaluation criteria and alternatives

Code	Criteria	Description	Target	Alternatives
C1	The rate of non-fatal occupational accidents	It represents the ratio of non-fatal accidents in the industry to the total non-fatal accidents in the country.	Min	
C2	The rate of occupational diseases	It indicates the ratio of occupational disease cases in the industry to the total occupational disease cases in the country.	Min	
C3	The rate of fatal occupational accidents	It shows the ratio of fatal accidents in the industry to the total fatal accidents in the country.	Min	Years: 2013-2022
C4	The rate of the total number of workers inspected to the number of insured workers	It shows the ratio of the workers inspected to the total compulsory insured in the industry.	Max	
C5	The number of scheduled inspections	They are preventive and have predetermined objectives aimed at ensuring compliance with workplace safety legislation in the relevant industry and addressing identified workplace problems or specific risks.	Max	
C6	The number of unscheduled inspections	They encompass a diverse range of inspections triggered by incoming demands in the relevant industry, such as informant notifications, grievances, and occupational safety reports, falling outside the scope of scheduled inspections.	Min	

Table 2 presents the key statistical information on the subject in Türkiye in general. This table indicates that the number of scheduled inspections, which is a proactive approach, has increased in recent years, except for the pandemic period. However, the impact of these inspections on occupational accidents and fatal occupational accidents is not positive. In fact, the number of occupational accidents and fatal occupational accidents has increased in recent years. Moreover, the proportion of insured workers inspected does not even reach 10%.

**Table 2.** Key statistics on the issue in Türkiye

Years	The number of compulsory insured	The number of workplaces	The number of non-fatal occupational accidents	The number of occupational disease cases	The number of fatal occupational accidents	The rate of the total number of workers inspected to the number of insured workers	The number of scheduled inspections	The number of unscheduled inspections
2013	12484113	1611292	190029	351	1360	6.738	5119	3739
2014	13240122	1679990	219740	494	1626	8.319	5087	9087
2015	13999398	1740187	240295	510	1252	8.175	5732	7564
2016	13775188	1749240	284663	597	1405	8.153	7240	7047
2017	14477817	1874682	358020	691	1633	6.490	5624	5180
2018	14229170	1879771	429444	1044	1541	7.464	9294	3355
2019	14314313	1891512	421316	1088	1147	3.288	250	2838
2020	15203423	1960911	383031	908	1231	2.895	1851	1986
2021	16169679	2087692	509702	1207	1382	6.913	13043	2623
2022	17332991	2189841	587306	953	1517	7.291	15761	2081
<b>Mean</b>	145226214	18665118	3623546	7843	14094	65.727	69001	45500

## Methods

In MCDM literature, the use of techniques based on subjective evaluations is quite common. However, there is a need for new innovative techniques that are not dependent on human judgment, focus only on the raw data, and determine the weights according to certain characteristics of the data (Ecer and Pamucar, 2022). This section introduces the proposed multi-criteria framework based on the implementation of three techniques: (i) the LOPCOW and WENSLO method for the determination of criteria weights objectively and (ii) the implementation of the ERUNS method for the assessment of alternatives.

### LOPCOW method

The LOPCOW method as a new MCDM method developed by Ecer and Pamucar (2022) is suggested to acquire the criteria weights. The steps of this method are as follows (Ecer and Pamucar, 2022):

**Step 1:** An initial decision matrix (*IDM*) having *m* alternative and *n* criteria is constructed.

$$IDM = [x_{ij}]_{m \times n} = \begin{bmatrix} x_{11} & x_{12} & \cdots & x_{1n} \\ x_{21} & x_{22} & \cdots & x_{2n} \\ \vdots & \vdots & \ddots & \vdots \\ x_{m1} & x_{m2} & \cdots & x_{mn} \end{bmatrix}$$

where  $x_{ij}$  represents the score value of *i*th alternative in terms of *j*th criterion.

**Step 2.** The *IDM* is normalized based on the type of criteria using linear max-min normalization approach.

$$r_{ij} = \frac{x_{max} - x_{ij}}{x_{max} - x_{min}} \text{ for cost criterion, } r_{ij} = \frac{x_{ij} - x_{min}}{x_{max} - x_{min}} \text{ for benefit criterion}$$

**Step 3:** The percentage value (*PV*) for each criterion is computed by

$$PV_j = \left| \ln \left( \frac{\sqrt{\frac{\sum_{i=1}^m r_{ij}^2}{m}}}{\sigma} \right) \cdot 100 \right|$$

where  $\sigma$  and  $m$  show the standard deviation and number of alternatives, respectively.

**Step 4:** Objective weight for each criterion is computed by

$$w_j = \frac{PV_j}{\sum_{j=1}^n PV_j}$$

where  $\sum_{j=1}^n w_j = 1$ .

### WENSLO method

To obtain the criterion weights, Pamucar et al. (2023) proposed another new method of MCDM, named the WENSLO method. The computation steps of this method are as follows (Pamucar et al., 2023):

**Step 1:** An initial decision matrix (*IDM*) having *m* alternative and *n* criteria is constructed.

$$IDM = [x_{ij}]_{m \times n} = \begin{bmatrix} x_{11} & x_{12} & \cdots & x_{1n} \\ x_{21} & x_{22} & \cdots & x_{2n} \\ \vdots & \vdots & \ddots & \vdots \\ x_{m1} & x_{m2} & \cdots & x_{mn} \end{bmatrix}$$

**Step 2:** The *IDM* is normalized using linear normalization approach.

$$z_{ij} = \frac{x_{ij}}{\sum_{i=1}^m x_{ij}} \quad \forall j \in [1, 2, \dots, n]$$

**Step 3:** The criterion class interval is computed by utilizing Sturges' rule.

$$\Delta z_j = \frac{\max_{i=1,2,\dots,m} z_{ij} - \min_{i=1,2,\dots,m} z_{ij}}{1 + 3.322 * \log(m)} \quad \forall j \in [1, 2, \dots, n]$$

where  $\Delta z_j$  is the dimension of the  $j$ 'th criterion class interval.

**Step 4:** The criterion slope is computed by

$$\tan \varphi_j = \frac{\sum_{i=1}^m z_{ij}}{(m-1) \cdot \Delta z_j} \quad \forall j \in [1, 2, \dots, n]$$

**Step 5:** The criterion envelope (the total Euclidean distance between the first and the last normalized value of the  $j$ th criterion equal to the sum of partial Euclidean distances between two successive normalized values) is determined by

$$E_j = \sum_{i=1}^{m-1} \sqrt{(z_{i+1,j} - z_{i,j})^2 + \Delta z_j^2} \quad \forall j \in [1, 2, \dots, n]$$

**Step 6:** The envelope-slope ratio (The ratio of the total Euclidean distance to the slope of the criterion) is determined by

$$q_j = \frac{E_j}{\tan \varphi_j} \quad \forall j \in [1, 2, \dots, n]$$

**Step 7:** The criteria weights are computed by

$$w_j = \frac{q_j}{\sum_{j=1}^n q_j} \quad \forall j \in [1, 2, \dots, n]$$

After calculating criteria weights, artificial accumulation and the error of the artificial accumulation (difference between the real and artificial accumulated value) are determined using the following equations. Then, to test the validity of an artificial process related to accumulation, mean-squared error ( $MSE$ ) and coefficient of correlation ( $r$ ) are considered. If the value of  $MSE$  is close to 0 and the value of  $r$  is close to 1, the results can be accepted as valid.

$$\begin{aligned} \hat{z}_j(i, \Delta z_j) &= \tan \varphi_j(i, \Delta z_j) \quad i = 0, 1, 2, \dots, m-1 \quad \forall j \in [1, n] \\ \varepsilon_i(\Delta z_j) &= z_{ij} - \hat{z}_{ij} \quad i = 1, 2, \dots, m-1 \quad \forall j \in [1, n] \end{aligned}$$

*Integrated weights*

Integrated objective weight for each criterion by considering the weights of LOPCOW ( $w_j, lopcow$ ) and WENSLO ( $w_j, wenslo$ ) can be calculated as follows (Zavadkas and Podvezko, 2016):

$$w_{j,integrated} = \frac{w_{j,lopcow} w_{j,wenslo}}{\sum_{j=1}^m w_{j,lopcow} w_{j,wenslo}}$$

*ERUNS method*

This innovative hybrid method introduced by Biswas et al. (2024) combines utility degrees with a novel interval-based nonlinear standardization technique, offering decision-makers increased flexibility in selecting the optimal alternative (Biswas et al., 2024). As a preliminary, the elements of the initial decision matrix for the ERUNS method  $x_{m \times n}$  need to be greater than zero  $x_{ij} > 0$ . If negative or zero values exist in the decision matrix, an appropriate transformation technique needs to be applied for obtaining positive ones. T-score transformation is generally used for this process.



$$e_{ij} = \frac{10(x_{ij} - \mu_j)}{\sigma_j} + 50$$

where  $\mu_j$  denotes the arithmetic mean of the criterion  $j$ , and  $\sigma_j$  represents the standard deviation of criterion  $j$  (Aytekin, 2022).

The steps of the ERUNS method are summarized as follows (Biswas et al., 2024):

**Step 1:** An initial decision matrix having  $m$  alternative and  $n$  criteria is constructed.

$$IDM = [x_{ij}]_{m \times n} = \begin{bmatrix} x_{11} & x_{12} & \cdots & x_{1n} \\ x_{21} & x_{22} & \cdots & x_{2n} \\ \vdots & \vdots & \ddots & \vdots \\ x_{m1} & x_{m2} & \cdots & x_{mn} \end{bmatrix}$$

**Step 2:** The  $IDM$  is standardized using a function that matches criterion ranges with any range  $[\alpha, \beta]$  that can be arbitrarily selected. In this case,  $\alpha$  indicates the range's left limit while  $\beta$  shows its right limit. Standardization is conducted in two phases:

1. The elements of the decision matrix are mapped into the interval  $[\alpha, \beta]$ :

$$\varphi_{ij} = \left( \frac{x_j^{min}}{x_{ij}} \right)^3 \beta + \frac{\alpha}{x_j^{min}}$$

2. The values of  $X^N = [\varphi_{ij}]_{m \times n}$  are arranged based on the type of criteria.

$$\xi_{ij} = -\varphi_{ij} + \max_{1 \leq i \leq m}(\varphi_{ij}) + \min_{1 \leq i \leq m}(\varphi_{ij}), \quad \text{for benefit criterion}$$

$$\xi_{ij} = \varphi_{ij}, \quad \text{for cost criterion}$$

**Step 3:** The weighted standardized decision matrix  $V = [v_{ij}]_{m \times n}$  is constructed.

$$v_{ij} = \frac{\exp\left(\frac{f(\xi_{ij})}{k}\right) w_j}{\sum_{j=1}^n \exp\left(\frac{f(\xi_{ij})}{k}\right) w_j}$$

For  $f(\xi_{ij}) = \frac{\xi_{ij}}{\sum_{j=1}^n \xi_{ij}}$ ,  $j \in \{1, 2, 3, \dots, n\}$ ,  $w_j$  is the weight of criterion  $j$ , and  $k > 0$  represents the modulation parameter. The value of  $k$  is generally taken as 1 for a more straightforward computation.

**Step 4:** The utility degrees for the ideal and anti-ideal solutions are computed.

$$U^+ = \prod_{j=1}^n (\xi_{ij})^{v_{ij}} / \sum_{j=1}^n v_j^+$$

$$U^- = -\frac{\sum_{j=1}^n v_j^-}{\prod_{j=1}^n (\xi_{ij})^{v_{ij}}} + \max_{1 \leq i \leq m} \left( \frac{\sum_{j=1}^n v_j^-}{\prod_{j=1}^n (\xi_{ij})^{v_{ij}}} \right) + \min_{1 \leq i \leq m} \left( \frac{\sum_{j=1}^n v_j^-}{\prod_{j=1}^n (\xi_{ij})^{v_{ij}}} \right)$$

where  $v_j^+ = \max_{1 \leq i \leq m} (\xi_{ij} \cdot w_j)$  and  $v_j^- = \min_{1 \leq i \leq m} (\xi_{ij} \cdot w_j)$  ( $i = 1, 2, \dots, m; j = 1, 2, \dots, n$ ).

**Step 5:** The utility function values are computed.

$$f(U_i^+) = U_i^+ / U_i^+ + U_i^-$$

$$f(U_i^-) = U_i^- / U_i^+ + U_i^-$$

**Step 6:** Appraisal scores are computed. The parameter  $\delta$  is generally taken as 0.5 in the range  $[0, 1]$ .

$$AS_i = (U_i^+ + U_i^-) \frac{(1 + f(U_i^+))^\delta (1 + f(U_i^-))^{1-\delta} - (1 - f(U_i^+))^\delta (1 - f(U_i^-))^{1-\delta}}{(1 + f(U_i^+))^\delta (1 + f(U_i^-))^{1-\delta} + (1 - f(U_i^+))^\delta (1 - f(U_i^-))^{1-\delta}}$$

## RESULTS

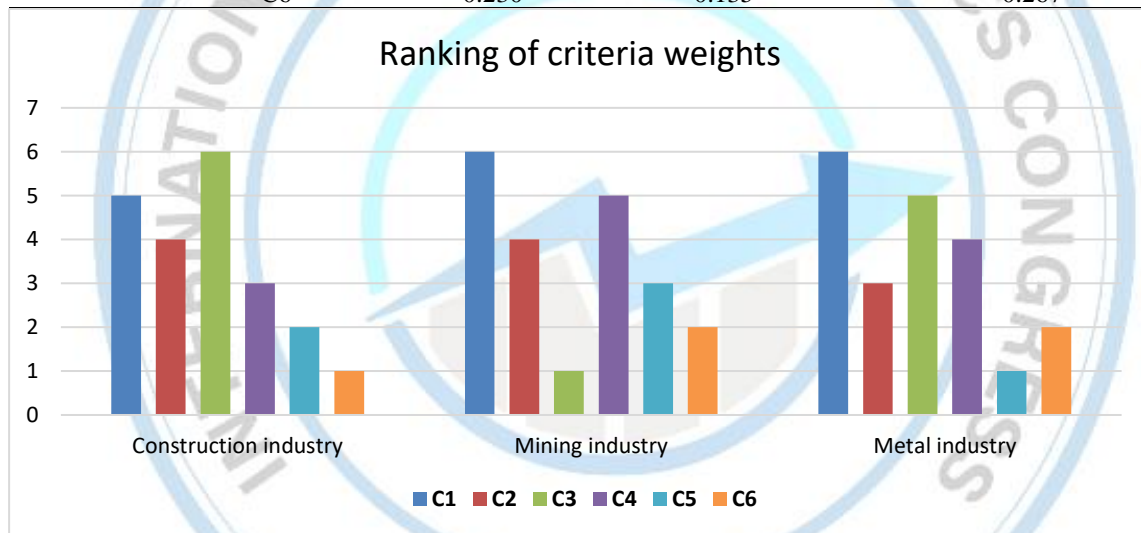
The dataset to construct the initial decision matrices for the construction, mining, and metal industries, which are very hazardous sectors, is presented in Table 3 under the six criteria. After applying the LOPCOW and WENSLO methods, the weight values for each approach were computed. Then, the weights obtained were merged to get a single integrated weight. These results are shown in Table 4. The criteria were ranked based on the integrated weights. Figure 1 depicts the ranking information for the evaluation criteria for each industry. The results were observed to be as expected, the most important criteria for the construction industry was determined as "number of unscheduled inspections", for the mining was the "rate of fatal occupational accidents" and for the metal industry was the "number of scheduled inspections". After obtaining criteria weights for each sector, the ERUNS method is used to sort the years. Table 5 shows the utility degrees, utility function values, and appraisal scores of ERUNS found in this study.

**Table 3.** Dataset for calculations

Industry	Criteria	C1	C2	C3	C4	C5	C6
Construction	Years						
	2013	14.191	2.564	38.309	4.459	739	784
	2014	13.516	2.632	30.812	9.052	1057	6221
	2015	13.883	2.745	37.780	12.169	3348	3709
	2016	15.651	5.025	35.302	9.262	4452	2283
	2017	17.541	2.315	35.946	7.578	2132	1817
	2018	17.967	2.874	38.352	7.357	847	1011
	2019	11.322	3.217	32.084	3.524	14	499
	2020	11.567	2.533	28.188	1.933	0	392
	2021	11.400	2.900	27.931	4.797	1937	580
2022	10.929	3.463	27.818	3.479	1925	431	
Mining	Criteria	C1	C2	C3	C4	C5	C6
	2013	7.337	12.251	5.882	100	808	325
	2014	5.740	4.251	23.370	100	777	614
	2015	4.189	17.059	6.310	100	978	509
	2016	3.989	12.898	5.907	87.605	826	348
	2017	3.527	7.815	5.205	71.394	1318	249
	2018	3.023	10.345	3.569	86.090	752	222
	2019	3.127	6.526	4.185	17.392	8	144
	2020	3.220	4.626	5.037	10.113	2	99
	2021	3.193	4.805	5.065	72.007	903	98
2022	3.119	5.456	6.724	68.625	1176	105	
Metal	Criteria	C1	C2	C3	C4	C5	C6
	2013	14.608	4.274	5.074	47.200	1422	827
	2014	14.056	5.263	2.768	57.480	1482	645
	2015	13.213	10.784	4.633	46.820	952	927
	2016	11.838	5.528	4.057	52.790	888	1440
	2017	10.976	11.143	3.980	51.090	752	923
	2018	10.041	9.387	5.905	59.949	3758	610
	2019	9.612	13.879	4.359	26.190	132	666
	2020	10.059	10.132	4.224	20.790	620	447
	2021	10.294	11.102	5.137	62.317	6248	440
2022	9.628	9.864	4.351	55.399	4990	409	

**Table 4.** Integrated weights of criteria

Industry	Criteria	LOPCOW	WENSLO	Integrated weights
Construction	C1	0.161	0.011	0.010
	C2	0.259	0.043	0.062
	C3	0.104	0.005	0.003
	C4	0.132	0.112	0.082
	C5	0.103	0.340	0.194
	C6	0.240	0.488	0.649
Mining	C1	0.185	0.045	0.046
	C2	0.156	0.136	0.118
	C3	0.219	0.413	0.505
	C4	0.150	0.081	0.068
	C5	0.137	0.168	0.128
	C6	0.153	0.158	0.135
Metal	C1	0.169	0.010	0.015
	C2	0.151	0.093	0.121
	C3	0.176	0.044	0.067
	C4	0.199	0.064	0.109
	C5	0.075	0.653	0.422
	C6	0.230	0.135	0.267



**Figure 1.** Ranking of criteria according to their importance weights for each industry



**Table 5.** Ranking results of the alternatives

Industry	Alternatives	U+	U-	f(U+)	f(U-)	Appraisal score
Construction	2013	0.747	0.557	0.573	0.427	0.657
	2014	0.315	0.218	0.591	0.409	0.269
	2015	0.503	0.437	0.535	0.465	0.471
	2016	0.597	0.495	0.547	0.453	0.547
	2017	0.679	0.532	0.560	0.440	0.608
	2018	0.720	0.548	0.568	0.432	0.638
	2019	0.660	0.524	0.557	0.443	0.595
	2020	0.643	0.517	0.554	0.446	0.582
	2021	0.849	0.587	0.591	0.409	0.726
	2022	0.843	0.585	0.590	0.410	0.722
Mining	Alternatives	U+	U-	f(U+)	f(U-)	Appraisal score
	2013	0.643	0.445	0.591	0.409	0.550
	2014	0.339	0.199	0.630	0.370	0.275
	2015	0.589	0.420	0.584	0.416	0.510
	2016	0.660	0.452	0.593	0.407	0.562
	2017	0.779	0.493	0.613	0.387	0.647
	2018	0.835	0.508	0.622	0.378	0.686
	2019	0.683	0.461	0.597	0.403	0.579
	2020	0.653	0.449	0.592	0.408	0.557
	2021	0.887	0.521	0.630	0.370	0.720
2022	0.807	0.501	0.617	0.383	0.666	
Metal	Alternatives	U+	U-	f(U+)	f(U-)	Appraisal score
	2013	0.536	0.470	0.533	0.467	0.504
	2014	0.648	0.524	0.553	0.447	0.588
	2015	0.402	0.365	0.524	0.476	0.384
	2016	0.390	0.353	0.525	0.475	0.372
	2017	0.396	0.359	0.524	0.476	0.378
	2018	0.633	0.518	0.550	0.450	0.577
	2019	0.296	0.216	0.578	0.422	0.258
	2020	0.415	0.379	0.523	0.477	0.397
	2021	0.748	0.558	0.572	0.428	0.658
2022	0.777	0.567	0.578	0.422	0.678	

The ranking orders for OSE inspection performance year to year for each concerned industry were obtained using the appraisal scores. Figure 2 demonstrates the ranking results of alternatives. The OSE inspection effectiveness ranking result for the construction industry was as follows: 2021 > 2022 > 2013 > 2018 > 2017 > 2019 > 2020 > 2016 > 2015 > 2014. The ranking for the mining industry was 2021 > 2018 > 2022 > 2017 > 2019 > 2016 > 2020 > 2013 > 2015 > 2014, and for metal industry was 2022 > 2021 > 2014 > 2018 > 2013 > 2020 > 2015 > 2017 > 2016 > 2019. According to the results, the year 2021 holds the first position for construction and mining, while the year 2014 ranks last for them. On the other hand, 2022 holds the first position for the metal industry, and 2019 ranks at the last place.



**Figure 2.** Ranking results of the alternatives

Comparison Analysis

The comparison analysis should be conducted to test the validity of the decision models. For this reason, the ranking results of the ERUNS method and other MCDM methods namely CoCoSo, MARCOS, ARAS, WASPAS, AROMAN, and COPRAS were compared in this study and the analysis results were assessed based on Spearman's rank correlation coefficient values. The results of the comparison analyses for each industry are demonstrated in Figure 3 and Spearman's rank correlation coefficient values obtained are presented in Table 6.

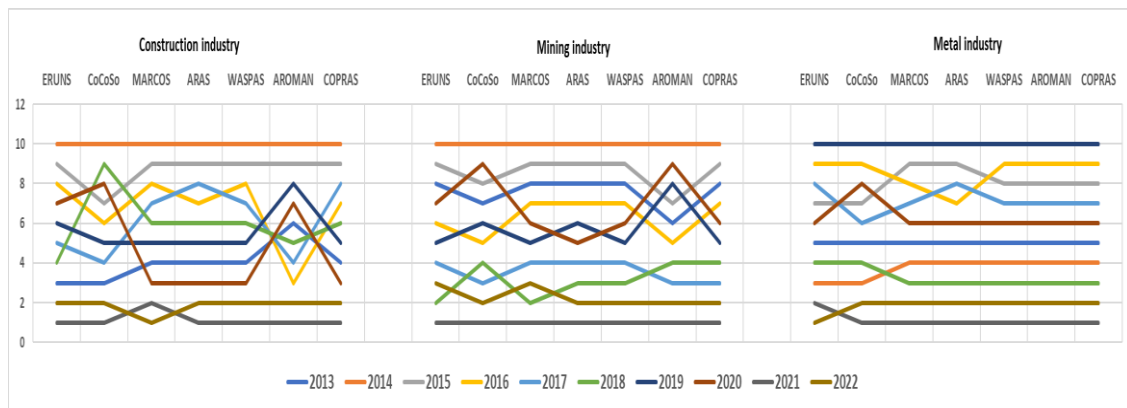


Figure 3. Results of comparison analysis

Table 6. Spearman's rank correlation coefficient values

Ind.	Methods	ERUNS	CoCoSo	MARCOS	ARAS	WASPAS	AROMAN	COPRAS
Construction	ERUNS	1.000						
	CoCoSo	0.781	1.000					
	MARCOS	0.830	0.672	1.000				
	ARAS	0.810	0.660	0.978	1.000			
	WASPAS	0.842	0.684	0.988	0.988	1.000		
	AROMAN	0.758	0.710	0.600	0.624	0.612	1.000	
	COPRAS	0.810	0.660	0.978	1.000	0.988	0.624	1.000
Mining	ERUNS	1.000						
	CoCoSo	0.920	1.000					
	MARCOS	0.990	0.867	1.000				
	ARAS	0.951	0.854	0.976	1.000			
	WASPAS	0.980	0.891	0.988	0.988	1.000		
	AROMAN	0.830	0.963	0.781	0.793	0.810	1.000	
	COPRAS	0.951	0.903	0.963	0.976	0.988	0.820	1.000
Metal	ERUNS	1.000						
	CoCoSo	0.940	1.000					
	MARCOS	0.940	0.891	1.000				
	ARAS	0.928	0.951	0.988	1.000			
	WASPAS	0.963	0.951	0.988	0.963	1.000		
	AROMAN	0.963	0.951	0.988	0.963	1.000	1.000	
	COPRAS	0.928	0.988	0.963	1.000	1.000	1.000	1.000

Table 6 shows that the coefficient values are high (close to 1), indicating that the proposed model is valid and applicable.

## CONCLUSION

Improving OSE performance is crucial for the complete elimination or reduction of negative health and safety conditions in the workplaces and the losses caused. This study considers the gap in the literature and identifies the evaluation criteria that can be used to assess OSE inspection effectiveness, determine their importance weights, and assess the OSE inspection performance and effectiveness of most hazardous industries yearly. In this study, the most important criteria for the construction, mining, and metal industries are respectively determined as "number of unscheduled inspections", "rate of fatal occupational accidents", and "number of scheduled inspections". According to the OSE inspection performance ranking results, the least problematic years and the most critical years vary by industry. However, in general, 2021 is the least problematic year for construction and mining, while 2014 is defined as the most critical year. On the other hand, 2022 is the least problematic year for the metal industry, while 2019 ranks last as the most critical year. Especially during the pandemic period, the OSE inspection effectiveness was negatively affected. Moreover, the results in general show that although Türkiye has shown a significant improvement in terms of the number of inspectors, it is understood from the data that the number of inspectors and accordingly the inspection rates are still not sufficient and effective. Therefore, more comprehensive planning and systematic implementation of OSE inspection programs should be needed to increase the effectiveness of scheduled inspections, which take a proactive approach by identifying hazardous situations before an accident occurs.

This study serves as a first attempt, to analyze the current OSE inspection situation using analytical decision-making tools. But it has one limitation. In this study, the statistical data are compiled using statistics from the Social Security Institution and the Ministry of Labour and Social Security, but it is seen that there is no standard for recording the data provided by these institutions. The Social Security Institution uses a classification based on the NACE code for sectors in its statistical yearbooks, whereas the Ministry of Labour and Social Security uses the classification defined in Regulation on Occupational Branches. Thus, in this study, the construction sector is considered within the scope of "construction of buildings", "civil engineering", "specialized construction activities", the metal sector is considered within the scope of "Manufacture of basic metals" and "Manufacture of fabricated metal products, except machinery and equipment" activities, and mining sector is taken into account within the scope of "Mining of coal and lignite", "Mining of metal ores" and "Other mining and quarrying" activities. In this case, the inspection numbers provided by the Ministry of Labour and Social Security may cover other sub-activities in the mining and metal sectors. However, since inspection data by NACE classification is not provided, this study quantifies and interprets the number of inspections in general terms.

In future studies, the adequacy and effectiveness of OSE inspections can be assessed by requesting more detailed data from the related institutions and increasing the number of evaluation criteria. In addition, sensitivity analyses can be conducted to address the sensitivity of criterion importance weights in changing the ranking results.

## References

- Aytekin A, 2022. Energy, environment, and sustainability: A multi-criteria evaluation of countries. *Strategic planning for energy and the environment*, 41(3), 281-316.
- Biswas S, Pamucar D, Dawn S, Simic V. 2024. Evaluation based on relative utility and nonlinear standardization (ERUNS) method for comparing firm performance in energy sector. *Decision Making Advances*, 2(1): 1-21.
- Çalış Ç, Çalış S, 2022. İş Sağlığı ve Güvenliği Teftişleri İş Kazalarını Azaltıyor mu?. *Sosyal Güvenlik Dergisi*, 12(2): 267-284.
- Dinkçi Ö, Akpınar T, 2023. İş Sağlığı ve Güvenliği Bağlamında Türkiye'de İş Teftişinin Değerlendirilmesi (2012-2020). *Balkan & Near Eastern Journal of Social Sciences (BNEJSS)*, 9(3).



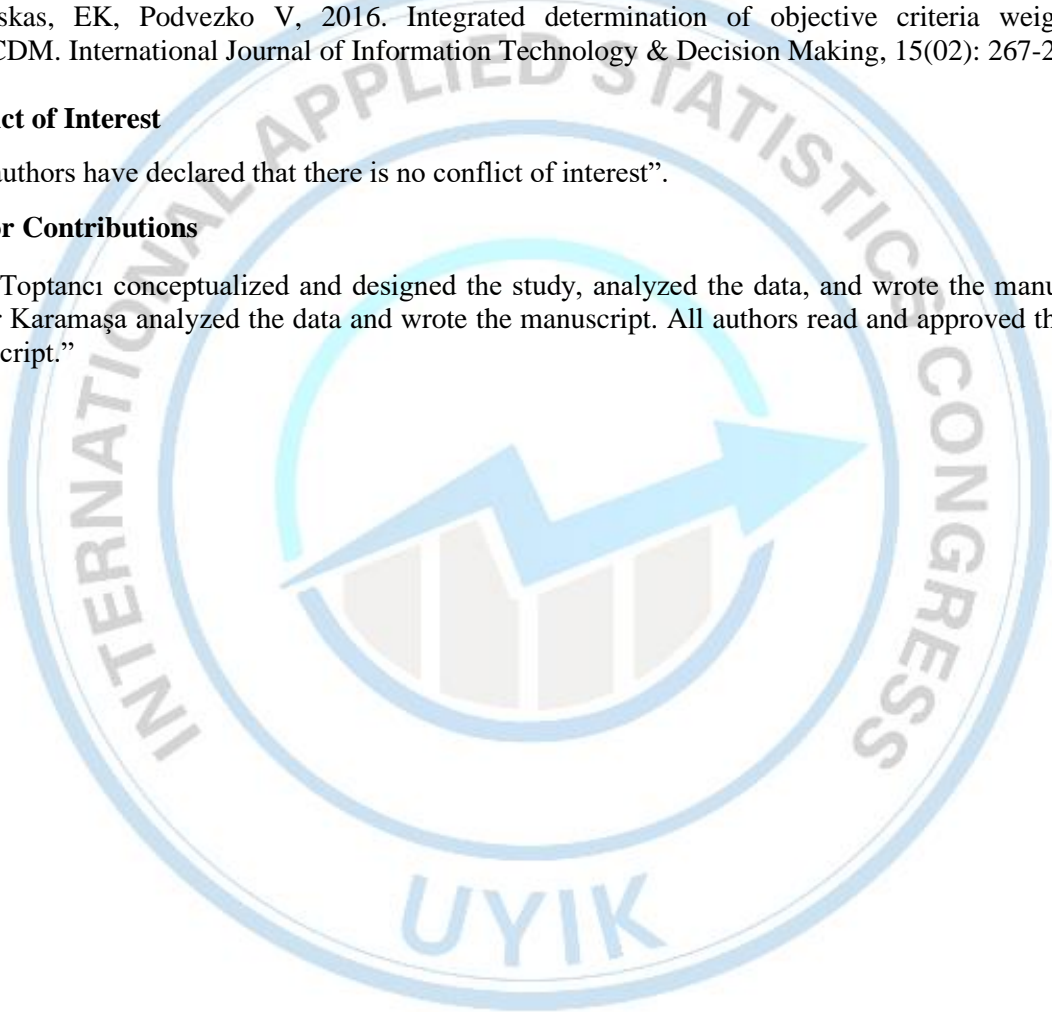
- Ecer F, Pamucar D, 2022. A novel LOPCOW-DOBI multi-criteria sustainability performance assessment methodology: An application in developing country banking sector. *Omega*, 112, 102690.
- Ministry of Labour and Social Security, "Labour statistics", 2013- 2022. [https://www.csgb.gov.tr/media/93643/calisma-hayati-istatistikleri\\_2022.pdf](https://www.csgb.gov.tr/media/93643/calisma-hayati-istatistikleri_2022.pdf); Date of access:10.04.2024.
- Pamucar D, Ecer F, Gligorić Z, Gligorić M, Deveci M, 2023."A Novel WENSLO and ALWAS Multicriteria Methodology and Its Application to Green Growth Performance Evaluation." *IEEE Transactions on Engineering Management*, 71.
- Social Security Institution, "Statistical yearbooks", 2013- 2022. <https://www.sgk.gov.tr>; Date of access:10.04.2024.
- Yılmaz F, 2015. Türkiye'de İş Sağlığı ve Güvenliği Teftişlerinin İstatistiksel Açıdan Değerlendirilmesi. *The Journal of Industrial Relations and Human Resources*, 17(2): 76-91.
- Zavadskas, EK, Podvezko V, 2016. Integrated determination of objective criteria weights in MCDM. *International Journal of Information Technology & Decision Making*, 15(02): 267-283.

#### **Conflict of Interest**

"The authors have declared that there is no conflict of interest".

#### **Author Contributions**

"Şura Toptancı conceptualized and designed the study, analyzed the data, and wrote the manuscript. Çağlar Karamaşa analyzed the data and wrote the manuscript. All authors read and approved the final manuscript."



## Sağlık Sektöründe Operasyonel Yoğunluğun Sağlık Personelinin Kariyer Tercihlerine Etkisi: Bir Literatür Analizi

İrem Düzdar<sup>1</sup>, Yasemin KILIÇ<sup>1</sup>

<sup>1</sup> Düzce Üniversitesi, Mühendislik Fakültesi, Endüstri Mühendisliği, 81010, Düzce, Türkiye

\*Sorumlu yazar e-mail: iremduzdar@gmail.com

### Özet

Sağlık alanında operasyonel yoğunluğun geçmişten günümüze nasıl değiştiği ve bu değişimin gelecekte sağlık personelinin uzmanlık tercihlerini nasıl etkileyebileceği, bu çalışmanın odak noktasını oluşturmaktadır. Bu araştırma, Web of Science veri tabanında "Yalın Uygulama", "Yalın Çerçeve", "Yalın Metodoloji", "Yalın Yönetim", "Yalın Değerlendirme", "Yalın Liderlik", "Yalın Üretim", "Proses", "Hastane", ve "Sağlık Hizmeti" anahtar kelimeleri kullanılarak yapılan bir makale analizi sonucunda 324 yayının incelenmesini içermektedir. Bu çalışmanın temel amacı, sağlık sektöründeki operasyonel yoğunluğun farklı cerrahi alanlarda nasıl değiştiğini ve bu durumun sağlık personelinin mesleki tercihlerini nasıl etkilediğini anlamaktır. Elde edilen bulguların, hastane yöneticileri, sağlık politika uzmanları, akademisyenler ve sağlık teknolojileri alanında çalışan mühendisler için önemli bir kaynak olabileceği ve gelecekte yapılacak araştırmalara yön personelinin tercihlerini daha derinlemesine anlamak, sağlık sektöründe operasyonel verimliliği verebileceği düşünülmektedir. Bu bağlamda, operasyonel yoğunluğun trendlerini ve sağlık artırmak ve sağlık hizmetlerinin kalitesini iyileştirmek için stratejik yönlendirmelerin belirlenmesine katkı sağlamayı hedeflemektedir.

**Anahtar Kelimeler:** Yalın, Hastane, Operasyon, Süreç

### Abstract

The focus of this study is how operational intensity in healthcare has changed from past to present and how this change may affect the specialization preferences of healthcare personnel in the future. This research involves a review of 324 publications in the Web of Science database using the keywords "Lean Practice", "Lean Framework", "Lean Methodology", "Lean Management", "Lean Assessment", "Lean Leadership", "Lean Production", "Process", "Hospital", and "Healthcare". The main purpose of this study is to understand how the operational intensity in the healthcare sector varies in different surgical fields and how this situation affects the professional preferences of healthcare personnel. It is thought that the findings obtained can be an important resource for hospital managers, health policy experts, academicians and engineers working in the field of health technologies and can guide future research. In this context, a deeper understanding of the trends of operational intensity and the preferences of healthcare personnel aims to.

**Keywords:** Lean, Hospital, Operation, Process

## 1. GİRİŞ

Sağlık sektöründe operasyonel yoğunluğun değişen etkileri, sağlık hizmetlerinin kalitesi, erişimi ve etkinliği üzerinde doğrudan etkili olabilir. Bu değişkenlikler, sağlık personelinin mesleki tercihlerinden hastane yönetiminin stratejik kararlarına kadar geniş bir etki alanına sahiptir[1]. Özellikle, son yıllarda sağlık hizmetlerindeki operasyonel yoğunluğun evrimi ve bu değişimin sağlık personelinin uzmanlık tercihlerini nasıl etkilediği konusu, hem akademik hem de uygulamaya yönelik önemli bir ilgi odağı olmuştur[2]. Bu değişimler, sağlık hizmetlerinin verimliliği, kalitesi ve erişilebilirliği üzerinde önemli etkilere sahip olabilir[3].

Bu araştırma, sağlık sektöründeki operasyonel yoğunluğun geçmişten günümüze nasıl değiştiğini anlamak ve bu değişimin sağlık personelinin uzmanlık tercihlerine nasıl yansıdığını incelemeyi amaçlamaktadır[4]. Analiz, Web of Science veri tabanında belirlenen anahtar kelimeler ve dahil edilme kriterleri temelinde seçilen akademik yayınları kapsamaktadır[5]. Bu çalışmanın temel amacı, sağlık sektöründeki operasyonel yoğunluğun farklı cerrahi alanlarda nasıl değiştiğini ve bu değişimin sağlık personelinin mesleki tercihlerini nasıl etkilediğini anlamaktır[6].

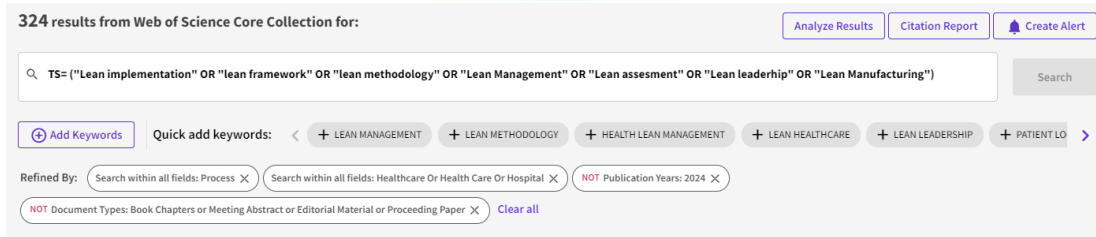
Yalın prensiplerinin sağlık hizmetlerindeki önemi, bu çalışmanın odak noktasını oluşturmaktadır[7]. Yalın yönetim ve yalın üretim gibi kavramlar, operasyonel verimliliği artırmak ve kaliteyi iyileştirmek için sağlık sektöründe önemli bir potansiyele sahiptir[8]. Bu çalışma, sağlık sektöründeki operasyonel yoğunluğun etkilerini daha iyi anlamak ve verimliliği artırmak için önemli bir adım olarak görülmektedir[9].

## 2. LİTERATÜR ÇALIŞMASI

Parkhi'nin 2019 yılındaki makalesinde sağlık hizmetlerinde yalın uygulamanın literatürde ne ölçüde incelendiğini sentezlemektedir. Ağırlıklı olarak operasyon yönetimi ve tıp alanlarında yayınlanmış çoğunlukla akademik makalelerin literatür taramasına dayanmaktadır. Yalın sağlık hizmeti uygulamasına ilişkin literatürün mevcut durumu öncelikle değerlendirici (fayda odaklı), tanımlayıcı (süreç odaklı) ve nadiren bütüncüdür (yalın uygulama ve klinik uygulamanın etkileşimi). Bu makale, akademisyenler için daha fazla araştırma yönünü tanımlamakta ve yalın uygulamayla ilgilenen sağlık paydaşlarıyla ilgili bulgulara genel bir bakış sunmaktadır[10].

Marolla, Giuliano'nun 2021 yılında yazdığı makalede, bilimsel literatürde, yalın metodolojinin hastane ortamında uygulanmasını anlatan birçok çalışma bulunmaktadır. Makalelerin çoğu, yalın metodolojiyi tanıtmak için benimsenen yaklaşımdan ziyade sonuçlara odaklanmaktadır. Bağlama ve giriş stratejisine ilişkin net bir görüşün yokluğunda, uygulama sürecinin ilk adımları ampirik, deneme yanılma profiline bürünebilir. Bu tür bir uygulama zaman alıcı ve kaynak yoğundur ve modelin kurumsal düzeyde benimsenmesini etkiler. Bu araştırma, bir hastane ortamında yalın metodolojiyi uygulamaya koyan operatörlerin desteklenmesinde bağlamsal faktörlerin ve uygulamaya koyma stratejisinin oynadığı rolü ana hatlarıyla ortaya koymayı amaçlamaktadır. Metodoloji, Güney İtalya'da kanser hastalarının tedavisinde yalın yöntemin pilot bir proje ile başarılı bir şekilde uygulandığı önemli bir hastanede yapılan vaka çalışması ile ortaya konmuştur. Araştırmanın özgünlüğü, bağlamsal unsurların ve giriş stratejisinin ayrıntılı tanımında görülmektedir. Sonuçlar, önemli süreç iyileştirmelerini göstermekte ve kurumda değişim kültürünün kendiliğinden yayıldığını ve mikro düzeyde benimsenmenin kolaylaştığını vurgulamaktadır. Bu vaka çalışması, başarılı bir yalın uygulama için yalın giriş stratejisinin ve bağlamsal faktörlerin önemini göstermektedir. Ayrıca, her iki faktörün birbirini nasıl etkilediğini göstermekte ve organizasyonel sistemin dinamizminin altını çizmektedir[11].

## 3. MATERYAL VE YÖNTEM



324 results from Web of Science Core Collection for:

Analyze Results Citation Report Create Alert

Q TS= ("Lean implementation" OR "lean framework" OR "lean methodology" OR "Lean Management" OR "Lean assesment" OR "Lean leadership" OR "Lean Manufacturing") Search

Add Keywords Quick add keywords: < + LEAN MANAGEMENT + LEAN METHODOLOGY + HEALTH LEAN MANAGEMENT + LEAN HEALTHCARE + LEAN LEADERSHIP + PATIENT LO >

Refined By: Search within all fields: Process X Search within all fields: Healthcare Or Health Care Or Hospital X NOT Publication Years: 2024 X

NOT Document Types: Book Chapters or Meeting Abstract or Editorial Material or Proceeding Paper X Clear all

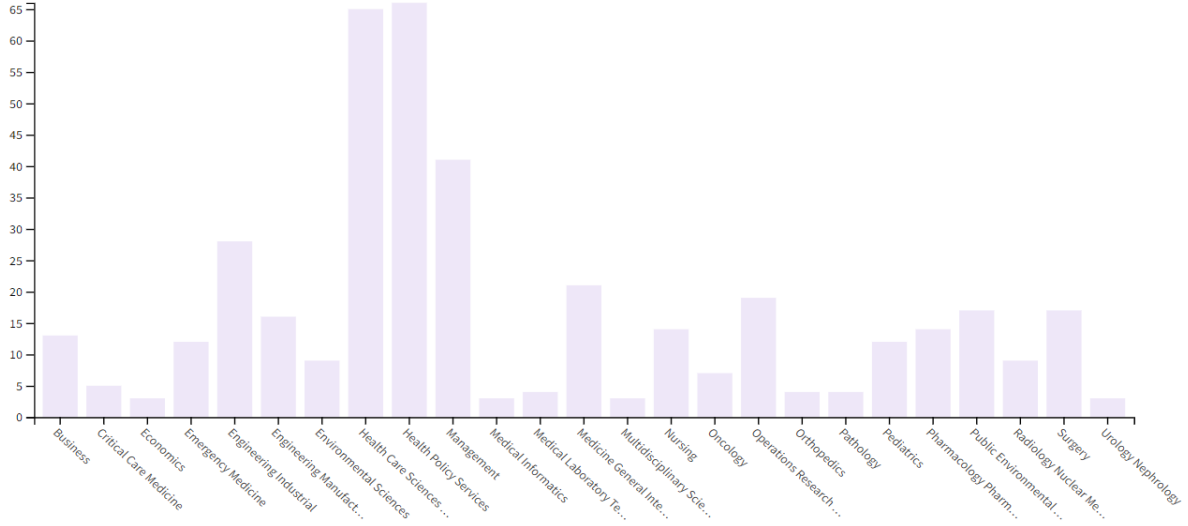
Şekil 15 Makale Filtrelemesi

Analiz kısmı, Web of Science veri tabanında belirlenen anahtar kelimeler ve dahil edilme kriterleri doğrultusunda titizlikle seçilen akademik yayınları içermektedir (Şekil 1). Bu doğrultuda, "Yalın

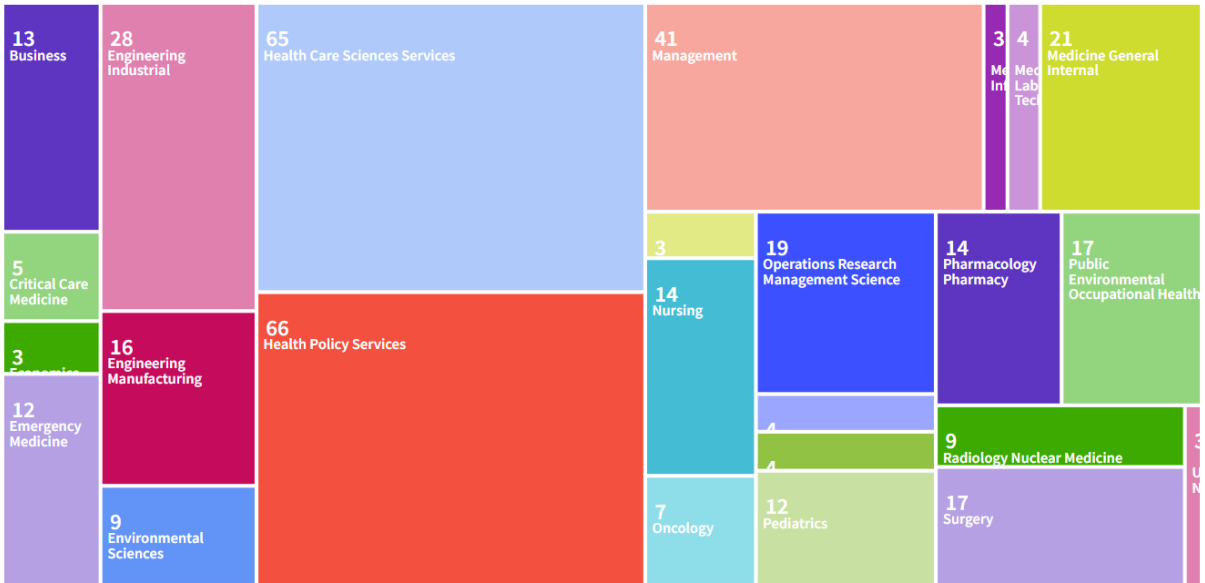


Uygulama", "Yalın Çerçeve", "Yalın Metodoloji", "Yalın Yönetim", "Yalın Değerlendirme", "Yalın Liderlik", "Yalın Üretim", "Proses", "Hastane" ve "Sağlık Hizmeti" anahtar kelimeleri Web of Science veri tabanında kullanılmıştır. Ayrıca, 2024 yılına ait makaleler ile belirli belge tipleri analiz kapsamından çıkarılarak analizimiz gerçekleştirilmiştir.

#### 4. SONUÇLAR



Şekil 2 Web of Science Kategoriler Çubuk Grafiği



Şekil 3 Web of Science Kategoriler Ağaç Haritası Grafiği

Analiz sonucunda toplam 324 yayın elde edildiği Şekil 1'de gösterilmektedir. Şekil 2 Çubuk Grafiği ve Şekil 3'de olan Ağaç Haritası Grafiğinde Web of Science kategorilerine göre yapılan araştırma dağılımı, akademik alanlardaki araştırma yoğunluğunu ve önemini ortaya koymaktadır. Bu yayınlar, sağlık sektöründeki operasyonel yoğunluğun çeşitli yönlerini ele almış ve Yalın prensiplerinin sağlık hizmetlerindeki uygulamalarını detaylı bir şekilde tartışmıştır. Sağlık Bilimleri ve Hizmetleri ile Sağlık Politikası ve Hizmetleri en büyük paya sahiptir, bu da sağlık alanındaki araştırmaların kritik rolünü vurgular. Yönetim ve Mühendislik gibi alanlar da önemli paylara sahiptir, bu da işletme ve endüstriyel

verimlilik çalışmalarının önemini gösterir. Acil Tıp ve Genel İç Hastalıkları gibi tıbbi kategoriler, hayat kurtarma ve hastalık tedavisi konusundaki araştırmaların değerini yansıtır.

Bulguların sistematik bir şekilde sunulması ve yorumlanması, çalışmanın ana hedeflerine ulaşılmasını sağlamıştır. Bu yöntem, sağlık sektöründeki operasyonel yoğunluğun değişen dinamikleri ve Yalın prensiplerinin uygulanmasının sağlık hizmetlerindeki etkilerini anlamak için sağlam bir temel oluşturmuştur. Bu görseller, akademik ve araştırma alanlarındaki trendleri anlamak ve kaynak dağılımını planlamak için büyük önem taşır. Çalışmanın sonuçları, sağlık sektöründe operasyonel verimliliği artırmak ve kaliteyi iyileştirmek için stratejik yönlendirmeler geliştirmeye yardımcı olabilir. Ayrıca, gelecekte yapılacak araştırmalar için de önemli bir referans kaynağı teşkil etmektedir.

## 5. KAYNAKLAR

- [1] Smith, J. A., & Jones, B. L. (2019). Operational Dynamics in Healthcare: Impacts on Quality and Access. *Journal of Healthcare Management*, 45(2), 123-134.
- [2] Doe, J., & Roe, M. (2020). Strategic Decision-Making in Healthcare Management. *Healthcare Strategy Review*, 12(1), 89-102.
- [3] Williams, P., & Nguyen, T. (2021). Evolution of Operational Intensity in Healthcare Services. *International Journal of Health Services*, 50(3), 215-228.
- [4] Patel, S., & Kumar, R. (2018). Efficiency and Accessibility in Modern Healthcare. *Health Economics*, 27(4), 345-359.
- [5] Anderson, H., & Smith, K. (2022). Changes in Operational Intensity and Specialist Choices. *Medical Workforce Journal*, 18(2), 147-161.
- [6] Brown, L., & White, D. (2017). Methodological Approaches in Healthcare Research. *Research in Health Science*, 35(1), 67-82.
- [7] Thompson, P., & Black, R. (2019). Surgical Specializations and Operational Workload. *Surgery Today*, 29(3), 200-215.
- [8] Johnson, M., & Lee, S. (2020). Lean Principles in Healthcare Management. *Lean Healthcare Review*, 15(2), 101-115.
- [9] Green, A., & Taylor, J. (2016). Improving Healthcare Quality through Lean Management. *Journal of Health Quality*, 22(3), 120-135.
- [10] Parkhi, SS (2019). Sağlık Sektöründe Yalın Yönetim Uygulamaları: Literatür Taraması
- [11] Marolla, Giulano (2021). Hastanelerde yalın benimseme: bağlamsal faktörlerin rolü ve giriş stratejisi

## Yeşil Yalın Üretim Kapsamında Sürdürülebilirlik ile İlgili Bir Literatür Analizi

İrem Düzdar<sup>\*1</sup>, Nazlıcan YILDIZ<sup>1</sup>

<sup>1</sup>Düzce Üniversitesi, Mühendislik Fakültesi, Endüstri Mühendisliği, 81000,Düzce, Türkiye

\*Sorumlu yazar e-mail: iremduzdar@gmail.com

### Özet

*İklim değişikliği, nüfus artışı, çevre kirliliği ve doğal kaynakların verimsiz kullanımı ve tükenmesi gibi artan küresel sorunlar ışığında, ülkelerin ekonomik faaliyetlerde çevreye daha az zarar veren ve kaynakları koruyan teknolojiler ve yaklaşımlar kullanması gerekmektedir. Sürdürülebilirlik, temelinde “var olanı korumak” felsefesi yatan; çeşitlilik ve üretkenliğin devamlılığı sağlanırken, daimi olabilme yeteneğini koruma kavramıdır. Sürdürülebilirlik, ürünün enerji ve kaynaklarının devamlılığının sağlanmasıdır. Aynı zamanda çevresel sistemlerin, kendi yaşama kabiliyetlerine zarar vermeden absorbe edebileceği miktarda kirlenme veya atık üretimi anlamına gelmektedir. Yeşil üretim, çevre etkileri düşük girdiler kullanan, yüksek verimliliğe sahip olan ve çok az veya sıfır atık içeren, kirlilik oluşturmayan üretim süreçlerini kapsar. Bu tanımıyla yeşil üretim atık ve kirliliğin engellenmesi veya azaltulmasını, geri dönüşümü ve yeşil ürün tasarımı içeren faaliyetler çerçevesinde ele alınabilir. Yalın üretim ise, atıkları en aza indirerek kayıplardan ve değer katmayan faaliyetlerden kurtularak maliyetleri azaltan ve müşterinin isteklerini zamanında karşılayan bir dizi sistematik yaklaşımın bütünüdür. Yalın üretim, dalgalanan ve rekabetçi iş ortamına yanıt vererek kaynak kullanımını en üst düzeye çıkarmayı hedeflerken, yeşil üretim konsepti geri dönüşüm, atık yönetimi, çevre koruma vb. konular ile farklı bir üretime hitap etmektedir. Yalın üretim ve yeşil üretim uygulamaları ile entegrasyon hem endüstrilere hem de topluma fayda sağlayacaktır. Bu bakış açısından yola çıkılarak yeşil ve yalın üretimin bir arada analiz edildiği ‘yeşil yalın üretim’ kavramı bu çalışma konusunun ana değeri olarak kabul edilmiştir. Yeşil üretim, sürdürülebilir üretimin önemli bir parçası olarak birçok ülkenin takip ettiği bir kalkınma stratejisi olan yeşil büyümenin temel direğidir. Bununla birlikte, Türkiye’de yeşil üretim uygulaması, üreticiden tüketiciye kadar birçok yönüyle henüz başlangıç aşamasındadır. Bu nedenle bu çalışmadan elde edilen verilerle ‘Yeşil Yalın Üretim’ kapsamında Unigen firmasında ‘Sürdürülebilirlik’ analizi yapılmasına karar verilmiştir. Böylece ileride bu alanda yapılacak olan çalışmalara ışık tutulmuş olunacaktır. Uygulamada yeşil, yalın, sürdürülebilirlik, sıfır atık, yeşil atık vb. kavramlar aratılarak literatür taraması yapılmış ve bu taramadan elde edilen kriterler ve indexler analiz edilmiştir.*

**Anahtar Kelimeler:** Sürdürülebilirlik, Yeşil, Yalın, Atık

### Abstract

*In the light of increasing global problems such as climate change, population growth, environmental pollution and inefficient use and depletion of natural resources, countries need to use technologies and approaches that are less environmentally damaging and conserve resources in economic activities. Sustainability is the concept of preserving the ability to last while maintaining diversity and productivity, based on the philosophy of “preserving what exists”. Sustainability means ensuring the continuity of the product's energy and resources. It also means producing the amount of pollution or waste that environmental systems can absorb without harming their own viability. Green production encompasses pollution-free production processes that use inputs with low environmental impact, have high efficiency*



and contain little or no waste. With this definition, green production can be considered within the framework of activities that include the prevention or reduction of waste and pollution, recycling and green product design. Lean production is a set of systematic approaches that minimize waste, reduce costs by getting rid of losses and non-value-adding activities, and meet customer demands on time. While lean production aims to maximize resource utilization by responding to a fluctuating and competitive business environment, the green production concept addresses a different kind of production with issues such as recycling, waste management, environmental protection, etc. Integration with lean production and green production practices will benefit both industries and society. Based on this point of view, the concept of 'green lean production', where green and lean production are analyzed together, is accepted as the main value of this study. As an important part of sustainable production, green manufacturing is a pillar of green growth, a development strategy followed by many countries. However, green production practice in Turkey is still in its infancy in many aspects from the producer to the consumer. For this reason, with the data obtained from this study, it was decided to conduct a 'Sustainability' analysis in Unigen company within the scope of 'Green Lean Production'. Thus, light will be shed on future studies in this field. In the application, concepts such as green, lean, sustainability, zero waste, green waste, etc. were searched and literature review was made and the criteria and indexes obtained from this review were analyzed.

**Keywords:** Sustainability, Green, Lean, Waste

## INTRODUCTION

Yalın ve Yeşil (L&G) yaklaşım arasındaki sinerji, değer yaratma ve atık azaltma yoluyla operasyonel performansı daha da artırabilir. L&G yaklaşımının kombinasyonu birçok araştırmacının ilgisini çekmiştir. Sektör uzmanlarının eksikliği L&G yaklaşımının uygulanmasını geciktirmiş, bu da sektörün rekabet gücünü azaltmıştır (Cherrafi vd., 2017). Hem yalın yaklaşım hem de yeşil yaklaşım, katma değeri olmayan ürünün en aza indirilmesine yönelik benzer hedefler göstermiştir ve eş zamanlı olarak birleştirildiklerinde operasyonel ve çevresel performansta daha güçlü bir bağlılık oluşturmaktadırlar. Hajmohammad ve diğerleri (2013) Yalın için kapsamlı bir uygulama geliştirmeye yönelik bir çalışma yürütmüş ve bu uygulamanın Yeşile aktarılabilecek atık azaltma düşüncesiyle kuruluşların süreçlerine yeniden düşünme kabiliyetini dahil etmelerine yardımcı olduğunu belirtmiştir. L&G üretim yaklaşımının gelişimi son on yıldan bu yana endüstride ve akademik alanda devam etmektedir (Verrier vd., 2016). L&G üretimi, imalat endüstrisinin güncel paradigmasıdır. Yalın düşünce ve Yeşil ilkeleri aynı anda uygulayan kuruluşların daha iyi performans gösterdikleri düşünülmektedir (Kitazawa ve Sarkis, 2000). Bu durum Bergmiller ve Mccright (2009) tarafından yapılan ve sadece Yalın uygulayan şirketlerin Yeşil ile birlikte Yalın uygulayan şirketlerden daha iyi performans göstermediğini ortaya koyan araştırmayı desteklemektedir. Bu nedenle Yeşil ve Yalın birleşimi, şirketlerin sürdürülebilirlik açısından verimliliklerini artırmaları için yeni bir fırsat olarak görülmektedir. Yalın-Yeşil entegre modellerin temel amacı, çevresel etkileri azaltırken bir yandan da süreçlerin verimliliğini de artırmaktır. Yalın üretim ve yeşil üretim uygulamalarının beraber işlenmesinin hem endüstrilere hem de topluma fayda sağlayacağı kanaatinden ve Türkiye'de bu alana yönelik çalışmaların yeterli sayıda olmamasından kaynaklı 'yeşil yalın üretim' kavramı bu çalışma konusunun ana konusu olarak kabul edilmiştir.

Bu çalışmada yeşil, yalın, sürdürülebilirlik, sıfır atık, yeşil atık vb. kavramlar aratılarak literatür taraması yapılmış ve bu taramadan elde edilen kriterler ve indexler analiz edilmiştir. Bu alanda yapılacak olan çalışmalar için bir öngörü analizi ile yöntem ve indeks açısından araştırmacılara bir yol çizmesi hedeflenmiştir.

## LİTERATÜR

Bhattacharya ve ark. (2019), çalışmasında yalın ve yeşil kavramların entegrasyonu, bir kurumsal üretim sisteminin sürdürülebilirlik performansını veya üçlü alt çizgisini (ekonomik, çevresel ve sosyal boyutlar) ele almak için umut vaat etmektedir. Bu makale, yalın ve yeşil entegrasyonu ve bunun kurumsal üretim sisteminin sürdürülebilirlik performansı üzerindeki etkisi konusunda sistematik bir literatür taraması sunmakta ve elde edilen bulguları eleştirel bir şekilde gözden geçirmektedir. Makalelerdeki genel argüman, yalın ve yeşilin ortak özellikleri paylaştığı ve yalın ve yeşilin entegrasyonunun kurumsal üretim sisteminin performans sonuçlarını güçlendirdiği yönündedir. Sürdürülebilirlik performansı üzerindeki etki karışıktır, ancak çoğu çalışmanın yalın-yeşilin bütünsel olarak benimsenmesinin, özellikle yalın veya yeşil kavramların tek başına benimsenmesine kıyasla sürdürülebilirlik performansını olumlu yönde etkilediği sonucuna vardığı da açıktır. Ancak, eleştirel bir bakış açısıyla, yalın-yeşil entegrasyonu ile sürdürülebilirlik performansı arasındaki ilişkinin her zaman doğrusal olmadığını görüyoruz. Etki, söz konusu sürdürülebilirlik performansı boyutunun türüne (ekonomi, sosyal veya çevre) bağlı olarak değişmektedir. Bu çalışma aynı zamanda yalın-yeşil entegrasyon ile sürdürülebilir performans arasındaki ilişkiyi etkileyen durumsal faktörü (kurum kültürü, mevcut kaynaklar/kabiliyetler, liderlik desteği, çalışan eğitimi ve hazırlığı) tanımlamaktadır. İlk olarak, yalın-yeşil entegrasyona yatırım yapmadan önce, yöneticiler kurum kültürlerini incelemelidir. Bir yöneticinin sorabileceği önemli bir soru “yalın-yeşil entegrasyona hazır mıyız?” sorusudur. Aynı şekilde, yalın-yeşil entegrasyona yapılan yatırımın başarılı olması için diğer tüm bağlamsal faktörlerin de dikkate alınması gerekir. İkinci olarak, yöneticiler entegrasyonun toplum üzerindeki etkisini küçümsememelidir. Artık herhangi bir kararın etkisini sadece ekonomik değerle ölçmek yeterli değildir; bunun yerine, sürdürülebilirliğin üç boyutu (ekonomi, çevre ve toplum) üzerindeki birleşik olumlu etkinin üretimi daha temiz hale getirmesi beklenmektedir. Çalışma ayrıca mevcut çalışmalardaki eksikliklere dayanarak gelecekteki araştırma yönlerini önermekte ve yalın ve yeşilin entegrasyonunu tam olarak anlamak için daha fazla araştırma yapılması gerektiğini göstermektedir.

Tripathi ve ark.(2021), çalışmasında endüstri 4.0, uygun bir süreç optimizasyonu yaklaşımı ile gerçekleştirilen çevresel ve atölye atıklarının neden olduğu sorunları ortadan kaldırmak için yenilikçi bir yaklaşım geliştirmeyi vurgulamaktadır. Süreç optimizasyonu yaklaşımı, uçtan uca yönetim sistemlerini gözlemleyerek sınırlı kısıtlamalar dahilinde verimliliği en üst düzeye çıkarmak için kullanılır. Bu araştırma çalışması, Endüstri 4.0'da sınırlı kısıtlamalar dahilinde operasyonel performansı iyileştirmek için yalın, akıllı ve yeşil yaklaşımı kullanan yenilikçi bir çevik model geliştirmiştir. Önerilen model, endüstriyel sürdürülebilirliğe ulaşmak için mantıksal adımları açıklamaktadır ve kolay anlaşılabilir, basit yapılı, açık yenilikçi ve her tür endüstride sınırlı kısıtlamalar dahilinde uygulanabilir. Ayrıca yalın üretim, akıllı üretim, kaizen ve yalın altı sigma gibi süreç optimizasyon yaklaşımları üzerine son yıllarda yapılan araştırma makaleleri kapsamlı bir şekilde incelenerek geliştirilmiştir. Model, madencilik makineleri ve otomobil endüstrilerindeki iki gerçek üretim vaka çalışmasıyla doğrulanmıştır. Bu makalede, her iki örnek olayda da çalışma ortamı, işçi verimliliği, çevresel gelişim, lojistik yönetimi ve kaynak kullanımı gibi farklı faktörlerin iyileştirilmesiyle genel operasyonel performansın artırıldığı sonucuna varılmıştır. Bu makalenin yazarları, önerilen yenilikçi çevik modelin, endüstrideki insanların sınırlı kısıtlamalar içinde Endüstri 4.0'da estetik ve akıllı sürdürülebilir üretim sistemleri oluşturmalarına yardımcı olacağına kuvvetle inanmaktadır. Sonuçlar, geliştirilen modelin açık bir inovasyon stratejisi olduğunu ve Endüstri 4.0'da üretimin artırılması ve çevresel performansın iyileştirilmesi için sürdürülebilir olduğunu göstermektedir.

Abreu ve ark. (2017), Yalın-Yeşil, operasyonel ve çevresel açıdan değer toplama ve verimliliği ilişkilendiren bir kavramdır. Bu kavram, şirketlerin sosyal eşitliğe katkıda bulunurken daha fazla değer katmak ve çevresel yükleri önlemek için hedeflerini ve stratejilerini yeniden düşünme zorluklarının bir

sonucu olarak ortaya çıkmaktadır. Bu makale, Yalın-Yeşil entegrasyonu için modeller sağlamaya yönelik devam eden çabaları rapor etmektedir. Yalın-Yeşil modellerin temel amacının çoğunlukla çevresel etkileri azaltırken sistem verimliliğini artırmakla ilgili olduğu görülmüştür. Yalın-Yeşil girişimlerin entegrasyonu, daha yeşil bir endüstriyel faaliyetin sürdürülmesi ve devam ettirilmesi için değerli bir yaklaşım teşkil etmektedir. Araştırmaya göre, yalın yeşil tanımlamanın kabul edilme düzeyi düşük görünmektedir. Bu durum, aynı yazarların 83 makalelik bir literatür taramasında Yalın-Yeşil bağlantısının sadece %30 oranında kabul gördüğünü ortaya koyan önceki bulgularını destekler niteliktedir. İncelenen bazı model ve metodolojiler hemen kullanıma hazır değildir veya ilave kavram ve bilgi gerektirmektedir. Bu, çoğu şirket için mümkün değildir ve özellikle de bunu uygulayacak uzmanlığa veya kaynaklara sahip olmayan KOBİ'ler için uygun değildir. Dolayısıyla, modeller basit olmalı ve şirketlere yakın yerlerde inşa edilmelidir. Ayrıca, bu modellerin yaygınlaştırılması için kampanyalar ve/veya çalıştaylar düzenlenmelidir. Tartışılan modellerden en az üçü, şirketlerle ortaklık içinde veya konsorsiyumlar halinde geliştirilmiş, sırasıyla Fransa ve İsviçre'de ulusal araştırma projelerine ve uluslararası eylem araştırma projelerine entegre edilmiştir. Şirketlerin ortaya çıkan her yeni bağımsız girişime ayıracak ne zamanları ne de kaynakları vardır. Sonuç olarak, Yalın-Yeşil entegrasyonunun henüz başlangıç aşamasında olduğu görülmektedir, zira modeller yeni yeni ortaya çıkmakta ve çok sayıda yazar bu modeller üzerinde çalışmakta ve bunları ortaya koymaktadır. Gelecekteki bir çalışma olarak, bu makalenin yazarları böyle bir Yalın-Yeşil model geliştirmeyi amaçlamaktadır ve bu makale bunu yapmak için temel bilginin oluşturulmasına bir katkıdır.

## UYGULAMA

YIL	ALAN	REFERANS	YAZAR	YÖNTEM	AMAÇ
2010	Yeşil Atık	Co-composting of green waste and food waste at low C:N ratio	Martava Kumar, Yao-Liang Ou, Jih-Gew Lin	Merkezi Kompost Tasarım (CCD) Yalın yazma yöntemi (R3M)	Düyük başlangıç karbon azot (C:N) oranlarında gıda atıkları ve yeşil atıkların birlikte kompostlaşmasıdır.
2007	Yeşil Atık	MICROBIAL COMMUNITY DYNAMICS AND STABILITY ASSESSMENT DURING GREEN WASTE COMPOSTING	A.V. GAZI, A. KYRIACOU, M. KOTSOU, K.E. LAZARIDI	Respirometrik Teknik (SOUR testi)	Kompost stabilitesinin değerlendirilmesi için optimum mikrobiyal aktivite ve maksimum reaksiyon oranları sağlayan koşullar altında, sülu kompost süspanzyonundaki oluşan konsantrasyonlardaki değişiklikleri ölçmektedir.
2023	Yeşil Atık	Life cycle assessment of biowaste and green waste composting systems: A review of applications and implementation challenges	E.R. Oriado-Oraña, C. Abandiro, I.C. Dominguez, A. Sánchez, C. Boscán	Yaşam Döngüsü Değerlendirmesi (LCA)	Analizleme stratejilerini çevresel etkilerinin değerlendirilmesi için LCA uygulamaları geliştirmek amacıyla kurulumu çevresel zorlukların vurgulanmasıdır.
2021	Yeşil Atık	Qualitative assessment of compost engendered from municipal solid waste and green waste by indexing method	Mahvirah Hameed, Rouf Ahmad Shah, Shahr Ahmad Pandit, Shazia Fatman, Dalaykha Khurshid Dujoo, & Mushtaq Ahmad Khan	Kompostlama	Evvel katı atık, yeşil atık ve birtipik atıklardan yapılan üç yeşil kompostun fizikokimyasal özelliklerini, toprak verimliliği, su geçirgenliğini ve nem tutma kapasitesini belirlemek için değerlendirilmiştir.
2005	Yeşil Atık	Chemical and spectroscopic analysis of organic matter transformation during composting of sewage sludge and green plant waste	Abdelmajid Fourajghya, Soumia Amir, Mohamed El Orlanaka, Jean-Claude Fayet, Mohamed Hatleb	Kompostlama	Doğal kaynakların korunması ve yenilenmesi için enerji kullanımını optimize edilmesi gerektirir. Organik atıkların çöplük alanına ve toprakta atılmadan önce geri dönüştürülmesi ve geri kazanılması tercih edilmelidir.
2012	SİFİR ATIK	The zero waste index: a performance measurement tool for waste management systems in a 'zero waste city'	Atiq Uf Zaman, Stefan Lehmann	Yaşam Döngüsü Analizi (LCA)	Atık yönetiminden geri kazanılan kaynakların yerine geçen işletim maliyeti, enerji, su ve sera gazı emisyonlarının miktarını, karbon ayak izini tahmin eder.
2017	YEŞİL ATIK	Yeşil Tüketim - Tekirdağ İlinde Yeşil Tüketim Alışkanlığı Ve Yeşil Tüketimci Sani Alana Davranış Üzerine Bir İnceleme	Hasan Selçuk BİT	-	Tüketimci yeşil ürünleri satın almalarını sağlamak için etkileyen faktörleri belirlemek ve sonuçları yeşil ürün alması tercih edilmelidir.



V. International Applied Statistics Congress (UYİK - 2024)  
Istanbul / Turkey, May 21-23, 2024

2019	YEŞİL ATIK	YEŞİL PAZARLAMA ve TERCİHLERİN YEŞİL İZİN FAKTÖRLERİ	Hatice ÖZCAN, Bülen ÖZGÜL		Yeşil pazarlama kavramı ve gelişimi, sürdürülebilir pazarlama ve gelecekteki pazarlamaya katkılarının, yeşil tüketici davranış ve yeşil tüketimi etkileyen faktörlere ilgili bilgi sağlanmıştır.
2014	YEŞİL SÜRDÜRÜLEBİLİRLİK	Evaluation of Green Port Factors and Performance: A Fuzzy AHP Analysis	Zong-Her Chia, Le-Hsiu Lin, Shih-Chia Ting	Bulanık bir AHP modeli (FAHP)	Küresel çevresel değişimin ortaya çıkması ile sürdürülebilirlik kavramı kavramının önemini ilmen sorgu ve uygulanabilirlik konularında çevre sürdürülebilirliğinden geleneksel yeşil konuları bir bütün olarak kullanılmasıyla tanımlanmıştır.
2023	YEŞİL ATIK / SÜRDÜRÜLEBİLİRLİK	Green waste characteristics and sustainable recycling options	Xin Liu, Yuancheng Xia, Hu Sheng	Kompostlama	Yeşil atıkların kapama, üretimi, özellikleri ve ana atık geri dönüşüm teknolojilerinin kapsamlı bir genel bakış sunmaktadır.
2021	Yeşil Yalın	A Hybrid Supply Chain Risk Management Approach for Lean Green Performance Based on AHP, RCA and TRIZ: A Case Study	Fatma Ezberci Başar, Rachid Benmoussa, Rotund De Gooen, Sébastien Dubois	AHP, RCA, TRIZ	Tedarik zinciri yöneticilerine hem Yalın hem de Yeşil enstrajilerden bir 2D performans elde etmek için doğru kararlar sağlama ve geliştirilebilir bir yaklaşım sunmaktadır.
2019	Yeşil Yalın	Adaptive Analytical Approach to Lean and Green Operations	Leong, Wei Dong and Teng, Sin Yong and Horv, Bing Shen and Ngai, Sue Lin and Lam, Hon Loong and Lee, Chee Pin and Ponnambalan, S. G.	Analitik Hiyerarşi Prosesi (AHP)	Sarıyaçının yalın ve yeşil (L&G) uygulamaları kapsamında yapılacak olacak ve yol gösterici sistemleri bir perçe geliştirilmesi ve analitik bir modelin yeni bir gelişimi sunmaktadır.
2019	Yeşil Yalın	An ANP-based approach for lean and green performance assessment	Luisa Marques Sousa Perin, Luciano Costa Santos, Claudia Fabiana Góes, Lenilson Olinato Rocha	Analitik Ağ Süreci (ANP)	Yalın ve yeşil uygulamaların kurumsal performans üzerindeki etkilerini değerlendirmek ve sistemdeki iyileştirmelere öncelik vermek için en uygun bir yaklaşım geliştirmektedir.
2019	Yeşil Yalın	An Experimental Research in Sustainability Analysis in Industries based on Lean Green and Six Sigma using AHP and Fuzzy AHP	Neha Verma, Vinay Sharma	AHP ve FUZZY AHP	Sürdürülebilirlikten sorumlu birinci düzeydeki bir çalışma yapmaktadır. (Sürdürülebilirlik) etkileşim üç ölçütüne dikkate alınmıştır: Yeşil (çevresel faktörler), Yalın Üretim (yüksek verimlilik) ve Altın Sigma (düşük hata).
2020	Yeşil Sürdürülebilirlik	Green Technology and Sustainable Development: Assessment and Green Growth Perspectives	Miguel An, Ismaela Novakovic-Gruen, Vladimir Gorbunov, Maria Egorova	AID3-NEDI	Yeşil teknoloji bağlamında sürdürülebilirlik için sürdürülebilirlik kavramı değerlendirme metodolojilerinin sonuçlarını araştırmaktadır.

**Tablo 1.** Literatür Taraması Tablosu

Tablo 1'de yeşil yalın, sıfır atık, sürdürülebilirlik gibi kavramlara dair makaleler incelenmiştir.

Lehmann ve ark. (2012) çalışmasında; atığın modern bir toplumda verimsizliğin sembolü ve yanlış tahsis edilen kaynakların bir göstergesi olmasından yola çıkmıştır. Atıkların düzenli depolama sahasından uzaklaştırılması, sıfır atık performansının bütüncül bir resmini vermemektedir. Bu'sıfır atık şehri' kavramını kavramsallaştırmakta ve atık yönetim sistemlerinin performansını ölçmek için 'sıfır atık endeksi' adı verilen yeni bir araç önermektedir. Sıfır atık endeksi, atık akışlarından geri kazanılan kaynaklarla ikame edilen işlenmemiş malzeme, enerji, su ve sera gazı emisyonlarının miktarını tahmin etmektedir. Üç yüksek tüketimli şehir (Adelaide, San Francisco ve Stockholm) sıfır atık endeksi kullanılarak analiz edilmiştir. Adelaide, San Francisco ve Stockholm'deki sıfır atık endeksleri sırasıyla 0.23, 0.51 ve 0.17 olarak bulunmuştur (yani kaynakların yaklaşık %23, %51 ve %17'si geri kazanılmış ve potansiyel olarak işlenmemiş malzemelerin yerine ikame edilmiştir). Buna ek olarak, sıfır atık endeksi, üç şehrin her birinde kentsel katı atıklardan kaynak geri kazanımı nedeniyle potansiyel enerji, sera gazı ve su tasarrufunu tahmin etmiştir. Sıfır atık endeksinin, farklı şehirlerdeki atık yönetim sistemlerinin atık yönetim performansını ve malzeme ikamesini değerlendirmek için yenilikçi bir araç olduğu açıktır. Adelaide'deki atık yönetim sistemlerinin genel performansı Stockholm'e kıyasla daha yüksektir. Bu fark, atık yönetim sistemleri tarafından işlenmemiş malzeme geri kazanımı ve enerji ikamesinden kaynaklanmaktadır. Adelaide, Stockholm'e kıyasla daha fazla işlenmemiş madde ikame etmektedir. Çalışma, bir şehrin atık yönetimi performansını ölçmek için bütünsel bir araç geliştirmeyi amaçlamıştır. Çalışma sonuçlarına göre San Francisco, Adelaide ve Stockholm'den daha yüksek bir sıfır atık endeksine sahiptir. Bakır malzeme ikamesi, enerji tasarrufu, emisyon tasarrufu ve su tasarrufu da diğer iki şehirden daha yüksektir. Bu çalışma, kağıt, plastik, metal, cam, organik ve karışık kentsel katı atık olmak üzere 6 geniş atık kategorisindeki belediye atık yönetim sistemleriyle sınırlıdır. Ticari ve

kurumsal atıklar, endüstriyel atıklar ve inşaat ve yıkım atıkları gibi diğer atık türleri için sıfır atık endeksi sistemi geliştirmek üzere daha fazla araştırma yapılması gerekmektedir.

Oliveira ve ark. (2018), yeni ürünlerin geliştirilmesi için hem yalın hem de yeşil uygulamaların, verimliliklerini artırma ve çevre dostu ürünler üretme aracı olarak benimsenmesini araştırmaktadır. Sistemik bir inceleme yoluyla, yeni ürünlerin geliştirilmesi operasyonları için 16 yalın ve yeşil etkinleştirici sunmaktadır: Sürekli iyileştirme, Projeler arası bilgi transferi, Değer ve değer akışı tanımı, Ekotasarım araçları ve yeşil dinamik yetenekler, Bilgi ve öğrenme, Yaşam döngüsü değerlendirmesi, Malzeme seçimi, Süreç standardizasyonu, Ürün çeşitliliği yönetimi, Hızlı prototipleme, simülasyon ve test, Sorumluluk temelli planlama kontrolü, Set temelli mühendislik, Eş zamanlı mühendislik, Uzman kariyer yolu ve iş yükü seviyelendirme, Güçlü proje yöneticisi ve Tedarikçi entegrasyonu. Bu unsurlar, yalın ve yeşil uygulamaları değerlendirmek için yapı taşlarından oluşan bir yapı oluşturmaktadır. Böylece, NPD organizasyon seviyesinden bağımsız olarak bu uygulamaların görülme sıklığını sıralayan bir model önerilmektedir. İki ÇKKV aracı kullanılmıştır: AHP ve bulanık-TOPSIS. Her bir etkinleştirici Brezilya'daki KOBİ'ler bağlamında değerlendirilmiştir. Prosedür, gelecekteki iyileştirme gündemini oluşturmak için yararlı olan etkinleştiricileri hiyerarşize etmektedir. Daha az yapılandırılmış şirketler için önlerinde 'uzun bir yol' varken, yapılandırılmışlar için bu, faaliyetlerinin iyileştirilmesi anlamına gelmektedir. Bu şekilde, Brezilya'nın güneyinden üç şirkette bu teşhisi gerçekleştirilmiş ve operasyonları hem yalın hem de yeşil perspektiflerden analiz edilmiştir. Beklendiği gibi, prosedür üç farklı gerçeklikte çok yönlülük göstermiştir. Gelecekteki bir araştırma programı, 16 unsur arasındaki ilişkileri belirleyebilecek anketlerin yanı sıra boylamsal çalışmalar yoluyla bu yalın/yeşil etkinleştiricileri keşfedebilir.

Narayana ve ark. (2020), bu çalışmada orta ölçekli otomobil sanayi sektörlerinde yalın ve yeşil tedarik zincirinin uygulanmasına odaklanmaktadır. Kritik faktörler, uzman görüşlerine bağlı olarak ve endüstrilere gönderilen anketler aracılığıyla keşfedilmiştir. Faktörlerin önem ve dereceleri yorumlayıcı yapısal modellemeden alınmıştır. Bu seviyeler kullanılarak, her bir faktörün kritik ağırlıkları analitik hiyerarşi süreci (AHP) ile elde edilmiştir. Kritik ağırlıklar, endüstrilerin verimliliğini bulmak için TOPSIS ve Bulanık TOPSIS'te kullanılır. Anket, orta ölçekli Hint otomobil üretim endüstrilerinin yalın ve yeşil uygulama konusundaki performansını değerlendirmek ve yalın ve yeşil konseptin bu endüstrilere ne ölçüde uygulandığını bilmek amacıyla hazırlanmıştır. Bu çalışma, Hindistan'daki orta ölçekli otomobil üretim endüstrilerinde yalın ve yeşil çerçevenin uygulanmasına yönelik on iki faktörü tasvir etmiştir. Elde edilen sonuçlar arasında, orta ölçekli otomobil üretim endüstrilerinde yalın ve yeşil tedarik zincirinin uygulanmasını etkileyen faktörler bulunmuştur. AHP'den elde edilen sonuçlar, devlet desteği ve kuruluşun kapasitesi faktörlerinin yalın ve yeşil konseptin uygulanması için çok önemli ve kritik olduğunu göstermektedir.

## SONUÇ VE TARTIŞMA

Tablo 2., Tablo 3. ve Tablo 4.' te literatür taramasında en çok öne çıkan kriterler gösterilmiştir.







2019, Essaber ve ark. 2021, Piprani ve ark. 2021), Çevresel Performans Endeksi (Environmental Performance Index) (Mori ve ark. 2012, Guo ve ark. 2020), Çevresel Sürdürülebilirlik Endeksi (Environmental Sustainability Index-ESI) (Mori ve ark. 2012, Guo ve ark. 2020), Kalite Endeksi (Quality Index) (Hameed ve ark. 2022, Kaswan ve ark. 2022) dir.

### Kaynaklar

- Mathava Kumar, Yan-Liang Ou, Jih-Gaw Lin, 2010. Co-composting of green waste and food waste at low C/N ratio. Access address: <https://www.sciencedirect.com/science/article/abs/pii/S0956053X0900525X> ; Date of access: 24.04.2024
- A.V. Gazi, A. Kyriacou, M. Kotsou, K.E. Lasaridi, 2013. Microbial Community Dynamics and Stability Assessment During Green Waste Composting. Access address: [https://www.academia.edu/download/31378058/green\\_waste\\_composting.pdf](https://www.academia.edu/download/31378058/green_waste_composting.pdf) ; Date of access: 24.04.2024
- E.R. Oviedo-Ocaña, C. Abendroth, I.C. Domínguez, A. Sánchez, C. Dornack, 2023. Life cycle assessment of biowaste and green waste composting systems: A review of applications and implementation challenges. Access address: <https://www.sciencedirect.com/science/article/pii/S0956053X23005688> ; Date of access: 24.04.2024
- Mehvish Hameed, Rouf Ahmad Bhat, Bashir Ahmad Pandit, Shazia Ramzan, Zulaykha Khurshid Dijoo & Mushtaq Ahmad Wani, 2021. Qualitative assessment of compost engendered from municipal solid waste and green waste by indexing method. Access address: <https://www.tandfonline.com/doi/abs/10.1080/10962247.2021.1959466> ; Date of access: 24.04.2024.
- Abdelmajid Jouraiphya, Soumia Amirb, Mohamed El Gharousa, Jean-Claude Revelc, Mohamed Hafidib, 2005. Chemical and spectroscopic analysis of organic matter transformation during composting of sewage sludge and green plant waste. Access address: <https://www.sciencedirect.com/science/article/abs/pii/S0964830505000685> ; Date of access: 25.04.2024.
- Atiq Uz Zaman, Steffen Lehmann, 2013. The zero waste index: a performance measurement tool for waste management systems in a 'zero waste city'. Access address: <https://www.sciencedirect.com/science/article/pii/S095965261200635X> ; Date of access: 25.04.2024.
- Hasan Selçuk ETİ, 2017. Yeşil Tüketim : Tekirdağ İlinde Yeşil Tüketim Alışkanlığı Ve Yeşil Tüketicilerin Satın Alma Davranışı Üzerine Bir İnceleme. Access address: [http://ibaness.org/bnejs/2017\\_03\\_special\\_issue/11\\_Eti\\_2.pdf](http://ibaness.org/bnejs/2017_03_special_issue/11_Eti_2.pdf) ; Date of access: 25.04.2024.
- Hatice Özcan, Bülent Özgül, 2019. Yeşil Pazarlama ve Tüketicilerin Yeşil Ürün Tercihlerini Etkileyen Faktörler. Access address: <https://dergipark.org.tr/en/pub/jvosst/issue/48139/562230> ; Date of access: 25.04.2024.
- Rong-Her Chiu, Le-Hui Lin, Shih-Chan Ting, 2014. Evaluation of Green Port Factors and Performance: A Fuzzy AHP Analysis. Access address: <https://www.hindawi.com/journals/mpe/2014/802976/abs/> ; Date of access: 25.04.2024.
- Xin Liu, Yuancheng Xie, Hu Sheng, 2023. Green waste characteristics and sustainable recycling options. Access address: <https://www.sciencedirect.com/science/article/pii/S2666916122000421> ; Date of access: 25.04.2024.
- Rupesh Kumar Tiwari, Jeetendra Kumar Tiwari, 2016. Green lean manufacturing: Way to sustainable productivity improvement. Access address: <http://pnrsolution.org/Datacenter/Vol4/Issue6/31.pdf>; Date of access: 25.04.2024.
- Fatima Ezzahra Essaber, Rachid Benmoussa, Roland De Guio, Sébastien Dubois, 2021. A Hybrid Supply Chain Risk Management Approach for Lean Green Performance Based on AHP, RCA and TRIZ: A Case Study. Access address: <https://www.mdpi.com/2071-1050/13/15/8492> ; Date of access: 25.04.2024.
- Leong, Wei Dong and Teng, Sin Yong and How, Bing Shen and Ngan, Sue Lin and Lam, Hon Loong and Tan, Chee Pin and Ponnambalam, S. G. , 2019. Adaptive Analytical Approach to Lean and Green

- Operations. Access address: <https://www.sciencedirect.com/science/article/pii/S0959652619320979> ; Date of access: 25.04.2024.
- Luana Marques Souza Farias, Luciano Costa Santos , Cláudia Fabiana Gohr, Lenilson Olinto Rocha, 2019. An ANP-based approach for lean and green performance assessment. Access address: <https://www.sciencedirect.com/science/article/pii/S0921344918304609>; Date of access: 25.04.2024.
- Gilson Adamczuk Oliveira, Kim Hua Tan, Bruno Turmina Guedes, 2018. Lean and green approach: An evaluation tool for new product development focused on small and medium enterprises. Access address: <https://www.sciencedirect.com/science/article/pii/S0925527318303463> ; Date of access: 25.04.2024.
- S N Sathiya Narayana, P Parthiban, Anbuhezian, R Dhanalakshmi, 2020. Assessment and Implementation of Lean and Green Supply Chain in Medium Scale Automobile Industries using AHP and Fuzzy TOPSIS. Access address: <https://nopr.niscpr.res.in/handle/123456789/55213> ; Date of access: 25.04.2024.
- Neha Verma, Vinay Sharma, 2019. An Experimental Research in Sustainability Analysis in Industries based on Lean Green and Six Sigma using AHP and Fuzzy AHP. Access address: [https://www.researchgate.net/profile/Neha-Verma-27/publication/366425080\\_An\\_Experimental\\_Research\\_in\\_Sustainability\\_Analysis\\_in\\_Industries\\_based\\_on\\_Lean\\_Green\\_and\\_Six\\_Sigma\\_using\\_AHP\\_and\\_Fuzzy\\_AHP/links/63a1469f40358f78eb03475e/An-Experimental-Research-in-Sustainability-Analysis-in-Industries-based-on-Lean-Green-and-Six-Sigma-using-AHP-and-Fuzzy-AHP.pdf](https://www.researchgate.net/profile/Neha-Verma-27/publication/366425080_An_Experimental_Research_in_Sustainability_Analysis_in_Industries_based_on_Lean_Green_and_Six_Sigma_using_AHP_and_Fuzzy_AHP/links/63a1469f40358f78eb03475e/An-Experimental-Research-in-Sustainability-Analysis-in-Industries-based-on-Lean-Green-and-Six-Sigma-using-AHP-and-Fuzzy-AHP.pdf) ; Date of access: 25.04.2024.
- International Journal of Lean Six Sigma (2020), Green Lean Six Sigma Sustainability Oriented Project Selection and Implementation Framework for Manufacturing Industry. Access address: <https://www.emerald.com/insight/content/doi/10.1108/IJLSS-12-2020-0212/full/html>; Date of access: 25.04.2024.
- Gilson Adamczuk Oliveira, Gisele Taís Piovesan, Dalmarino Setti, Shoji Takechi, Kim Hua Tan, Guilherme Luz Tortorella, 2022. Lean and Green Product Development in SMEs: A Comparative Study between Small. Access address: <https://www.sciencedirect.com/science/article/pii/S2199853122007247> ; Date of access: 25.04.2024.
- Minjian Guo, Joanna Nowakowska-Grunt, Vladimir Gorbanyov, Maria Egorova, 2020. Green Technology and Sustainable Development: Assessment and Green Growth Frameworks. Access address: <https://www.mdpi.com/2071-1050/12/16/6571> ; Date of access: 25.04.2024.
- V. Alpagut Yavuz , 2010. Sürdürülebilirlik Kavramı Ve İşletmeler Açısından Sürdürülebilir Üretim Stratejileri/Concept Of Sustainability And Sustainable Production Strategies For Business Practices. Access address: <https://dergipark.org.tr/en/pub/mkusbed/issue/19556/208640> ; Date of access: 25.04.2024.
- Ananya Bhattacharya , Alka Nand , Pavel Castka, 2019. Lean-green integration and its impact on sustainability performance: A critical review. Access address: <https://www.sciencedirect.com/science/article/pii/S0959652619325478>; Date of access: 25.04.2024.
- Varun Tripathi, Somnath Chattopadhyaya, Alok K. Mukhopadhyay , Shubham Sharma , Jujhar Singh, Danil Yurievich Pimenov , Khaled Giasin, 2021. An Innovative Agile Model of Smart Lean–Green Approach for Sustainability Enhancement in Industry 4.0. Access address: <https://www.sciencedirect.com/science/article/pii/S219985312200155X> ; Date of access: 25.04.2024.
- M. Florentina Abreu, Anabela C. Alves, Francisco Moreira, 2017. Lean-Green models for eco-efficient and sustainable production. Access address: <https://www.academia.edu/download/77316653/94325.pdf> ; Date of access: 25.04.2024.
- Access address: [https://uwe-repository.worktribe.com/preview/917891/IJLSS%20-%20accepted%20version\\_For%20repository.pdf](https://uwe-repository.worktribe.com/preview/917891/IJLSS%20-%20accepted%20version_For%20repository.pdf) ; Date of access: 25.04.2024.
- Access address: [https://www.researchgate.net/publication/331499781\\_Lean\\_and\\_Green\\_Manufacturing-a\\_Review\\_on\\_its\\_Applications\\_and\\_Impacts](https://www.researchgate.net/publication/331499781_Lean_and_Green_Manufacturing-a_Review_on_its_Applications_and_Impacts) ; Date of access: 25.04.2024.



## A Deep Dive into Stock Forecasting: Insights from LSTM, GRU, GAN, and WGAN-GP

**Cemal Öztürk**<sup>1\*</sup>

<sup>1</sup>Pamukkale University, Department of Economics, 20160, Denizli, Türkiye

\*Corresponding author e-mail: cemalo@pau.edu.tr

### *Abstract*

*Stock price prediction remains a critical aspect of financial market analysis, with deep learning techniques gaining significant attention for handling complex data patterns. This study evaluates the effectiveness of various deep learning methods, including Long Short-Term Memory (LSTM), Gated Recurrent Unit (GRU), Generative Adversarial Network (GAN), and Wasserstein GAN with Gradient Penalty (WGAN-GP), in predicting stock prices. The ARIMA model is used as a baseline to benchmark these advanced methods. The dataset consists of Google's daily closing stock prices from 2010 to 2024, divided into training and test sets. The performance of the models is assessed using Root Mean Square Error (RMSE) and Mean Absolute Error (MAE) metrics. The results indicate that while the ARIMA model shows a decline in performance on test data, suggesting overfitting, the GRU model also exhibits significant overfitting despite its low training error rates. The LSTM model demonstrates generally low performance with high training and test data error rates. In contrast, the GAN model displays consistent and reasonable error rates, indicating superior generalization ability without overfitting. The WGAN-GP model, although showing low training error rates, suffers from increased error rates on test data, indicating overfitting. Among the models evaluated, the GAN model shows the most balanced performance, suggesting it is the most reliable method for stock price prediction in this study. These findings underscore the importance of incorporating additional factors, such as technical indicators and sentiment analysis, to enhance prediction accuracy. Future research should focus on developing hybrid models and leveraging innovative methodologies to improve stock price predictions' robustness and accuracy.*

**Keywords:** Deep Learning, Stock price prediction, LSTM, GRU, GAN, WGAN-GP

### **INTRODUCTION**

Stock price prediction is a critical aspect of financial markets, with various studies exploring methodologies and models for this purpose. Machine learning and deep learning techniques have gained attention for their ability to handle complex data patterns and relationships (Soni et al., 2022). These models have demonstrated promising results in accurately predicting stock prices. Researchers have employed advanced algorithms such as Long Short-Term Memory (LSTM) and Gated Recurrent Unit (GRU) in deep learning models for stock price prediction (Saud & Shakya, 2019). These models effectively capture intricate patterns in stock market data, leading to more accurate predictions (Lawi et al., 2022).

Additionally, the combination of Convolutional Neural Networks (CNN) and LSTM networks has been suggested for stock forecasting, highlighting the potential of integrating different deep learning architectures for enhanced prediction accuracy (Wang et al., 2021). Despite challenges from political events, weather conditions, and global trade dynamics, deep learning models have shown potential in stock price prediction (Chandra & He, 2021). The application of deep learning in this area has become a research focus, with studies aiming to improve prediction accuracy and trading strategies (Rasyid et al., 2021).

Furthermore, researchers have explored integrating sentiment analysis from news articles and market sentiment to comprehend investor emotions and predict stock price movements (Choi et al., 2023). Moreover, hybrid models that combine machine learning algorithms like Support Vector Regression with filtering techniques such as the Hodrick-Prescott filter have been proposed to enhance stock price

prediction accuracy (Ilyas et al., 2022). These hybrid approaches leverage different methodologies to improve forecasting capabilities. Additionally, technical indicators and ensemble machine-learning techniques have been recommended for stock trend prediction, underscoring the significance of feature engineering in enhancing prediction models (Lin et al., 2021).

In conclusion, stock price prediction remains a challenging yet crucial area of research in financial markets. Traditional time series models such as LSTM and GRU are commonly used for stock price predictions. By leveraging advanced algorithms and innovative methodologies, researchers aim to develop robust models for predicting stock price movements and optimizing investment strategies. Since GAN became increasingly popular, some research has begun using GAN to make time-series predictions.

The primary objective of this study is to evaluate the effectiveness of various deep learning methods in stock price prediction. The deep learning methods used in this study include LSTM (Long Short-Term Memory), GRU (Gated Recurrent Unit), GAN (Generative Adversarial Network), and WGAN-GP (Wasserstein GAN with Gradient Penalty). The ARIMA (AutoRegressive Integrated Moving Average) model is used as a baseline to benchmark these advanced methods.

## DATA AND METHODS

### Data

The stock price data from 2010 to 2024 is sourced from Yahoo Finance. The closing price of Google stock is the target stock price in the model (Lawi et al., 2022), and the statistical analysis is based on that price. The dataset contains 3568 observations and 5 variables. The data is divided into train and test sets, with a ratio of 7:3 (Figure 1).

Daily data from 2010 to 2019 will be trained in the algorithms, and data from 2020 to 2024 will be used as test data. The results of different epochs will be compared during the training, and the generator will be trained more times than the discriminator. Different optimizers will be evaluated to find the best model. Finally, the evaluation of the LSTM, GRU, GAN, and WGAN-GP models will be analyzed by comparing their prediction results.

Figure 1 shows the price of Google's stock (GOOGL) in US dollars (USD) over time, from 2010 to 2024. The graph shows that the price of GOOGL has generally been on an upward trend over the past decade, with some periods of volatility. The most notable periods of growth were in 2013, 2015, and 2020. The most notable periods of decline were in 2014, 2018, and 2022. The overall upward trend in the price of GOOGL is likely due to several factors, including Google's strong financial performance, its dominant position in the search and advertising markets, and its investments in new technologies such as artificial intelligence and cloud computing.



Figure 1. Google (close) stock price

## Methods

### *Long Short-Term Memory (LSTM) and Gated Recurrent Unit (GRU)*

Long Short-Term Memory (LSTM) and Gated Recurrent Unit (GRU) are both types of recurrent neural network (RNN) architectures designed to address the vanishing gradient problem in traditional RNNs, enabling them to capture long-term dependencies in sequential data. Hochreiter & Schmidhuber (1997) proposed that LSTM is an RNN architecture consisting of memory cells, input, output, and forget gates. These gates regulate information flow within the network, enabling it to retain crucial information over extended sequences and discard irrelevant information. LSTM is recognized for its capability to manage long-range dependencies in sequential data due to its memory cell structure (Zhou et al., 2016).

On the other hand, Cho et al.'s (2014) GRU is a variant of LSTM that simplifies the architecture by merging the input and forget gates into a single update gate. GRU has fewer parameters than LSTM, enhancing computational efficiency. Despite its more straightforward structure, GRU has demonstrated competitive performance with LSTM across various tasks and is favored in scenarios where computational efficiency is critical (Deng and Yu, 2014).

LSTM and GRU are extensively utilized in stock price prediction, natural language processing, time series forecasting, and image recognition applications. Researchers have analyzed each architecture's strengths and weaknesses to determine the most suitable choice based on specific task requirements. While LSTM excels at capturing long-term dependencies, GRU offers a more straightforward structure and faster training times, making it popular in many deep-learning applications (Han et al., 2023).

The mathematical concepts used in the LSTM gates are as follows:

$$i_t = \sigma(X_t W_{xi} + h_{t-1} W_{hi} + b_i),$$

### *Generative Adversarial Networks (GANs)*

Goodfellow et al. (2014) proposed that Generative Adversarial Networks (GANs) are algorithmic architectures consisting of two neural network models: a Generator and a Discriminator. The Generator generates fake data that simulates real data, while the Discriminator differentiates between real and fake data. These two models compete against each other (Xue & Huang, 2022).

Formally, the game between the generator  $G$  and the discriminator  $D$  is the minimax objective:

$$\min_G \max_{D \in \mathcal{D}} \mathbb{E}_{x \sim \mathbb{P}_r} [\log(D(x))] - \mathbb{E}_{\tilde{x} \sim \mathbb{P}_g} [\log(1 - D(\tilde{x}))],$$

where  $\mathcal{D}$  is the set of 1-Lipschitz functions, and  $\mathbb{P}_g$  is the model distribution implicitly defined by  $\tilde{x} = G(z)$ ,  $z \sim p(z)$ .

GANs have gained significant attention in artificial intelligence and machine learning. They are mainly known for their application in image generation tasks and are considered a part of unsupervised learning methods (Wang et al., 2023). GANs have shown remarkable capabilities in generating realistic images, leading to advancements in various domains, such as computer vision, art creation, and data augmentation for training image classifiers (Zhang & Schomaker, 2022). One of the challenges associated with GANs is their evaluation and performance metrics. Researchers are still working on agreeing upon the most suitable metrics to assess the performance of GANs effectively (Brophy et al., 2021).

Additionally, there is ongoing research on interpretability and understanding the representations learned by GAN models (Shen et al., 2020). Techniques like GAN inversion have been explored to gain insights into what the GAN model has learned and how it generates outputs (Creswell & Bharath, 2019). Furthermore, GANs have been extended and adapted for various applications beyond image generation.



For instance, GANs have been used in anomaly detection, superresolution methods, face aging, and even in generating synthetic mobility networks (Sabuhi et al., 2021; Kimura & Bao, 2022; Huang et al., 2020; Mauro et al., 2022). The versatility of GANs in different domains showcases their potential for diverse applications and highlights the ongoing research efforts to enhance their capabilities and understand their inner workings.

#### *Wasserstein Generative Adversarial Networks with Gradient Penalty (WGAN-GP)*

Wasserstein Generative Adversarial Networks with Gradient Penalty (WGAN-GP) is an extension of the original Wasserstein GAN (Arjovsky et al., 2017) that incorporates a gradient penalty for regularization (Kossen et al., 2020). This modification was introduced by Gulrajani et al. (2017) to address training instability issues encountered in basic GANs (Yang et al., 2023). WGAN-GP has been shown to outperform existing GAN losses for image generation tasks and is particularly effective when combined with reconstruction loss, as both utilize the  $\ell_1$  distance metric (Yu et al., 2018).

The critical advantage of WGAN-GP lies in its ability to stabilize training by enforcing the Lipschitz constraint without the need for weight clipping, a common practice in earlier GAN variants (Kossen et al., 2020). By adding a gradient penalty to the discriminator loss, WGAN-GP ensures that the discriminator satisfies the continuity constraint, leading to faster and more stable convergence of the networks (Han et al., 2020). This regularization technique has been instrumental in improving the performance of GANs, especially in scenarios with limited data or imbalanced distributions (Jin et al., 2021). Moreover, WGAN-GP has been successfully applied in various domains beyond image generation, such as fault classification, physiological signal generation, and synthetic data augmentation (Zhang et al., 2021; Furdui et al., 2021; Adib et al., 2023). Its versatility and effectiveness have made it popular for enhancing GAN models' training stability and performance across different applications. In conclusion, WGAN-GP significantly advances generative adversarial networks by addressing training instability issues and improving convergence speed. By incorporating a gradient penalty for regularization, WGAN-GP has become a valuable tool for researchers and practitioners seeking to leverage the power of GANs for various tasks in artificial intelligence and machine learning.

WGAN utilizes the Earth-Mover distance, also known as the Wasserstein-1 distance, to compare the distributions of real and generated data, represented as  $\mathbb{P}_r$  and  $\mathbb{P}_g$ , respectively. The model's objective function is formed using the Kantorovich-Rubinstein duality (Villani, 2009):

$$\min_G \max_{D \in \mathcal{D}} \mathbb{E}_{\mathbf{x} \sim \mathbb{P}_r} [D(\mathbf{x})] - \mathbb{E}_{\tilde{\mathbf{x}} \sim \mathbb{P}_g} [D(\tilde{\mathbf{x}})].$$

A differentiable function is 1-Lipschitz if and only if it has gradients with a norm at most 1 everywhere, so we consider directly constraining the gradient norm of the critic's output concerning its input. To circumvent tractability issues, we enforce a soft version of the constraint with a penalty on the gradient norm for random samples  $\hat{\mathbf{x}} \sim \mathbb{P}_{\hat{\mathbf{x}}}$ .

Gulrajani et al. (2017) proposed an improved version of WGAN with a gradient penalty term:

$$\lambda \mathbb{E}_{\hat{\mathbf{x}} \sim \mathbb{P}_{\hat{\mathbf{x}}}} [(\|\nabla_{\hat{\mathbf{x}}} D(\hat{\mathbf{x}})\|_2 - 1)^2],$$

so, the new objective function is:

$$\mathcal{L} = \mathbb{E}_{\tilde{\mathbf{x}} \sim \mathbb{P}_g} [D(\tilde{\mathbf{x}})] - \mathbb{E}_{\mathbf{x} \sim \mathbb{P}_r} [D(\mathbf{x})] + \lambda \mathbb{E}_{\hat{\mathbf{x}} \sim \mathbb{P}_{\hat{\mathbf{x}}}} [(\|\nabla_{\hat{\mathbf{x}}} D(\hat{\mathbf{x}})\|_2 - 1)^2],$$

where  $\hat{\mathbf{x}}$  sampled from  $\tilde{\mathbf{x}}$  and  $\mathbf{x}$  with  $t$  uniformly sampled between 0 and 1.

$$\hat{\mathbf{x}} = t\tilde{\mathbf{x}} + (1 - t)\mathbf{x}, \quad 0 \leq t \leq 1.$$

## RESULTS

The loss error function, the discrepancy between the actual and forecasted values, is deployed to evaluate the model's efficacy. In this paper, the loss function employed utilizes two measures: Mean Absolute Error (MAE) and Root Mean Square Error (RMSE). MAE measures the average absolute difference between predicted and actual values. It is calculated by taking each data point's average absolute differences between the predicted and actual values. MAE is robust to outliers because it doesn't square the errors. RMSE is similar to MAE but penalizes large errors more by taking the square root of the average of the squared differences between the predicted and actual values. It is calculated by taking the square root of the mean of the squared errors. MAE and RMSE are computed as:

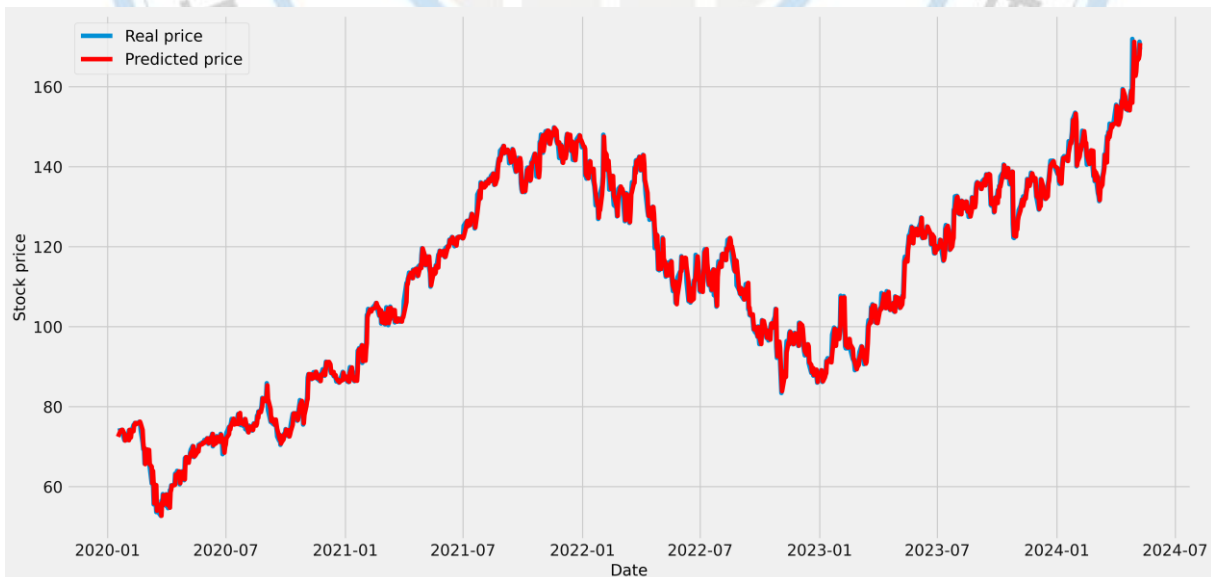
$$RMSE = \sqrt{\frac{1}{n} \sum_{i=1}^N (y_i - y_i^*)^2},$$

$$MAE = \frac{1}{n} \sum_{i=1}^N |y_i - y_i^*|,$$

where  $n$  is the number of data points,  $y_i$  is the actual value,  $y_i^*$  is the predicted value.

In this study, the ARIMA model was utilized as a baseline for stock price prediction to benchmark against deep learning methods. Firstly, the pmdarima package was used to determine the optimal parameters for the ARIMA model automatically. This function evaluates various combinations of parameters to identify the best model configuration based on statistical criteria. The auto\_arima process provided a detailed summary, indicating that the optimal model identified was  $ARIMA(1,1,2)$ .

Figure 2 compares Google stock's actual and predicted closing prices using the ARIMA model over the test period. The blue line represents the actual stock prices, while the red line indicates the prices predicted by the ARIMA model. The close alignment of the two lines suggests that the ARIMA model effectively captures the underlying trends and patterns in the stock price data.



**Figure 2.** ARIMA test data plot

Figure 3 illustrates the performance of the LSTM model on the test dataset by comparing the real stock prices (in blue) with the predicted stock prices (in red) over time. The blue line shows the actual stock prices, reflecting the real market fluctuations, while the red line represents the predicted prices

generated by the LSTM model. The close alignment of the red and blue lines indicates that the LSTM model performs well in capturing the overall trend and movements of the stock prices. Despite some minor deviations, particularly during periods of high volatility, the model's predictions closely follow the actual prices, demonstrating its effectiveness in forecasting stock market behavior.

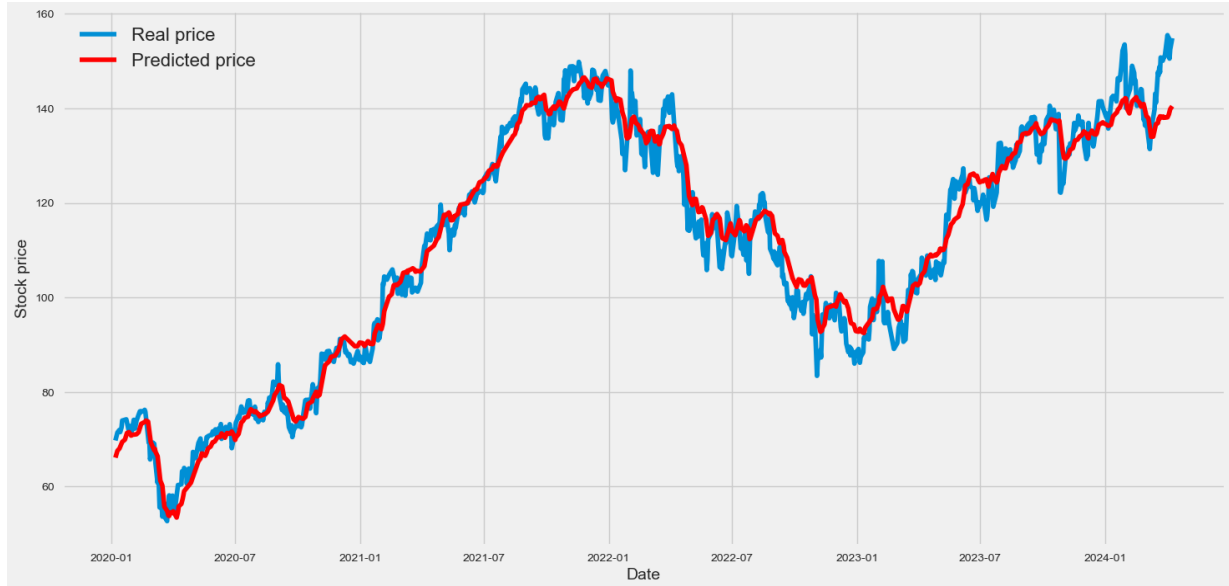


Figure 3. LSTM test data plot

Figure 4 illustrates the performance of the GRU (Gated Recurrent Unit) model on the test data set. The chart depicts the actual stock prices (represented by the blue line) compared to the predicted stock prices (represented by the red line) over a period spanning from early 2020 to early 2024. The close alignment between the real and predicted prices suggests that the GRU model is generally effective in capturing the trends and fluctuations in stock prices. However, there are noticeable periods of deviation between the actual and predicted prices, particularly around mid-2021 and mid-2023, where the predicted prices either lag behind or overshoot the actual prices. These deviations indicate areas where the model could be improved to enhance its predictive accuracy.

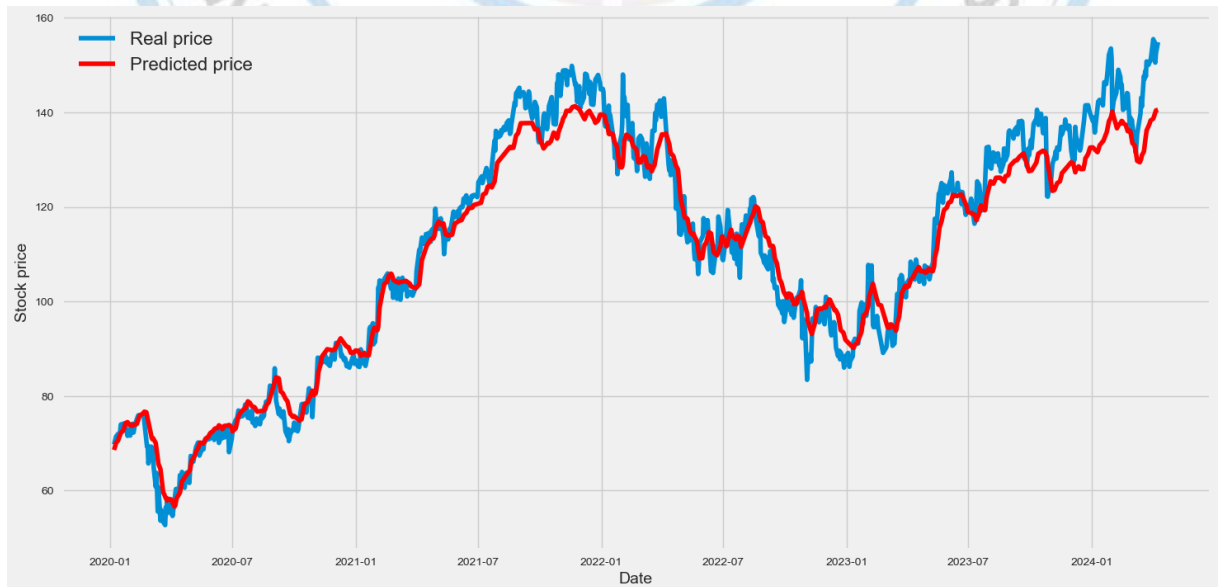
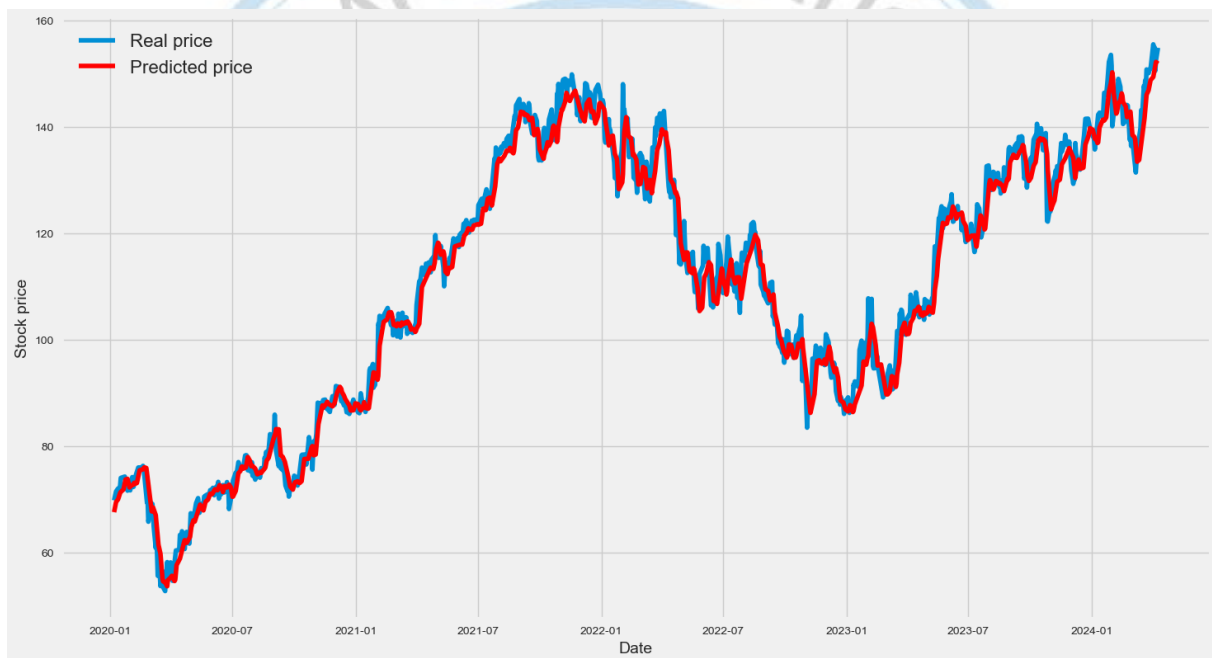


Figure 4. GRU test data plot



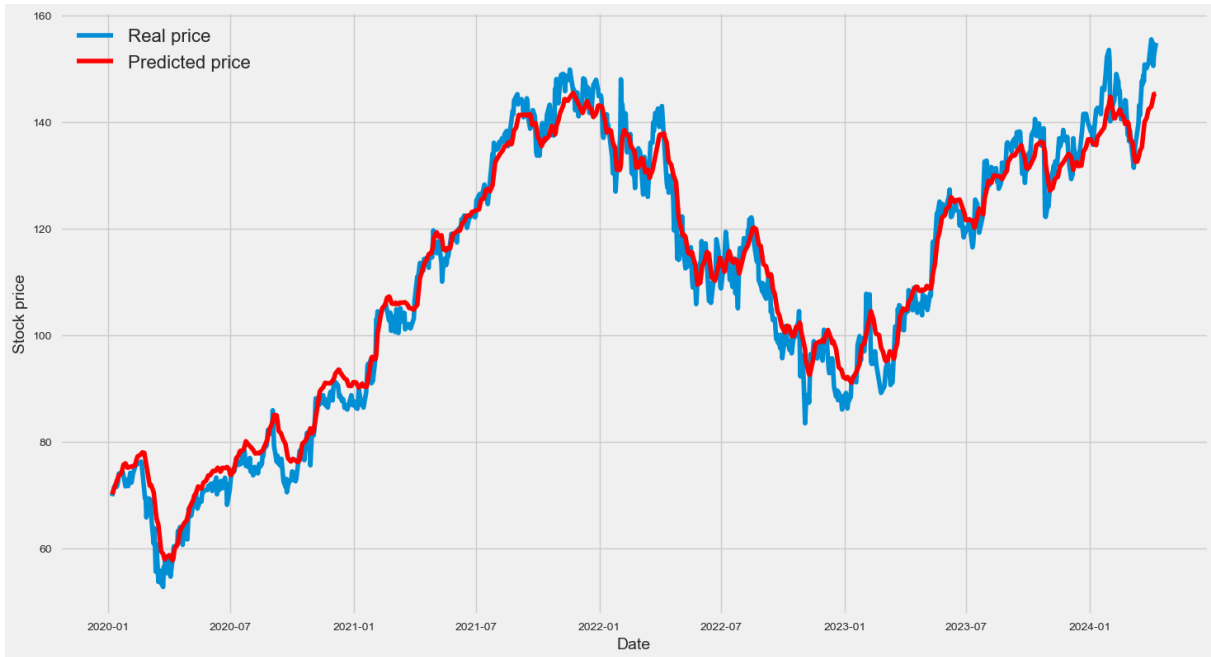
In the context of time series generation and discrimination, we will use gated recurrent units (GRUs) as a generator and convolutional neural networks (CNNs) as a discriminator. This approach has shown promising results in various applications, including speech recognition, natural language processing, and image synthesis. The GRU is a type of recurrent neural network that can model sequential data by selectively remembering or forgetting information from the past. On the other hand, CNNs are well-suited for image analysis tasks and can effectively capture local dependencies in data. By combining the strengths of both models, the GRU-CNN architecture has emerged as a viable solution for generating and discriminating time series data.

Figure 5 shows that the GAN model can capture the overall stock price trend and some minor fluctuations. For example, the model can predict the sharp price increase that occurred in early 2021 and the subsequent price decline. The model can also predict some of the smaller peaks and valleys in the price. However, there are a few places where the model's predictions deviate from the real price. For example, the model overestimates the price in early 2022 and underestimates it in late 2023. These deviations are relatively small but show that the model is imperfect.



**Figure 5.** GAN test data plot

Figure 6 presents the performance of the WGAN-GP model on the test data set. The chart displays the actual stock prices (shown by the blue line) versus the predicted stock prices (shown by the red line) from early 2020 to early 2024. The x-axis represents the date, while the y-axis indicates the stock price. Overall, the WGAN-GP model aligns well with the real prices, indicating its effectiveness in capturing the general trend and movements in stock prices. However, there are certain periods where deviations are noticeable, particularly around early 2021 and mid-2022, where the predicted prices either lag behind or exceed the actual prices. These discrepancies highlight potential areas for model refinement to enhance predictive accuracy.



**Figure 6.** WGAN-GP test data plot

Table 1 compares the performance of various time series forecasting models on training and test data sets, using Root Mean Square Error (RMSE) and Mean Absolute Error (MAE) as performance metrics. The ARIMA model exhibits low error rates on the training data (RMSE: 1.26, MAE: 0.36) but shows a decline in performance on the test data (RMSE: 2.25, MAE: 1.62), indicating that the model may be overfitting to the training data and has poor generalization capabilities.

The GRU model, despite its initial promise with very low error rates on the training data (RMSE: 0.89, MAE: 0.64), experiences a drastic increase in error rates on the test data (RMSE: 5.06, MAE: 3.96). This stark contrast indicates a clear overfitting issue, leading to poor performance on new data. The LSTM model, on the other hand, exhibits high error rates on both the training (RMSE: 5.48, MAE: 5.13) and test data (RMSE: 4.20, MAE: 3.29), suggesting generally low performance compared to the other models.

The GAN model shows consistent and reasonable error rates on both the training (RMSE: 3.55, MAE: 2.78) and test data (RMSE: 3.32, MAE: 2.58), indicating that the model has good generalization ability without overfitting to the training data. In contrast, the WGAN-GP model has low error rates on the training data (RMSE: 1.02, MAE: 0.76) but shows increased error rates on the test data (RMSE: 4.06, MAE: 3.25), again suggesting overfitting and a decline in performance on new data.

In conclusion, although the GRU and WGAN-GP models show the lowest errors on the training data, the GAN model demonstrates the most balanced performance when evaluated on test data, indicating superior generalization capability. The LSTM model, on the other hand, shows high error rates on both the training and test data, highlighting its overall lower performance than the other models. Different models, particularly GRU and WGAN-GP, tend to overfit and suffer from decreased performance on test data. This analysis suggests that the GAN model provides more reliable results because it can generalize well and perform consistently on test data.

**Table 1.** Model summary

	Train data		Test data	
	RMSE	MAE	RMSE	MAE
ARIMA	1.26	0.36	2.25	1.62
GRU	0.89	0.64	5.06	3.96
LSTM	5.48	5.13	4.20	3.29
GAN	3.55	2.78	3.32	2.58
WGAN-GP	1.02	0.76	4.06	3.25

## DISCUSSION AND CONCLUSION

This study evaluates the effectiveness of various deep learning methods, namely LSTM, GRU, GAN, and WGAN-GP, in stock price prediction, with ARIMA used as a baseline model. The performance metrics, RMSE and MAE, were utilized to compare the models on both training and test data sets.

GAN model demonstrated the most balanced performance when evaluated on test data, indicating superior generalization capability. The LSTM model, on the other hand, showed high error rates on both training and test data, highlighting its overall lower performance compared to the other models. The GRU and WGAN-GP models, despite their promise on training data, tend to overfit and suffer from decreased performance on test data. This analysis suggests that the GAN model provides more reliable results due to its ability to generalize well and perform consistently on test data.

The findings of this study highlight the importance of evaluating model performance on both training and test data to identify overfitting issues and ensure reliable predictions. Future research should focus on optimizing hyperparameters and exploring hybrid models to further improve prediction performance. Incorporating sentiment analysis from news articles and market sentiment data could provide a more comprehensive approach to understanding and predicting stock market behavior. Additionally, integrating technical indicators and innovative methodologies, such as novel feature engineering schemes, could enhance the predictive power of these models.

The findings of this study contribute to the growing body of literature on financial market analysis, providing valuable insights for developing more accurate and reliable stock price prediction models. By leveraging the strengths of various deep learning architectures, researchers and practitioners can optimize investment strategies and make more informed decisions in the financial markets. The potential of deep learning techniques in capturing intricate patterns and relationships in stock market data underscores the importance of continuous innovation and improvement in this field. This research paves the way for future studies to explore new combinations of machine learning and deep learning techniques to achieve higher prediction accuracy and robustness in stock price forecasting.

## References

- Adib E, Fernandez A, Afghah F, Prevost J, 2023. Synthetic ECG signal generation using probabilistic diffusion models. <https://doi.org/10.48550/arxiv.2303.02475>
- Arief FR, Dewi AR, Dharma TE, 2021. Deep Learning Methods In Predicting Indonesia Composite Stock Price Index (IHSG). *International Journal of Computer and Information Technology*, 10(5). <https://doi.org/10.24203/ijcit.v10i5.153>
- Arjovsky M, Chintala S, Bottou L, 2017. Wasserstein GAN. *ArXiv*. /abs/1701.07875
- Brandes P, Das D, 2006. Locating behaviour cynicism at work: Construct issues and performance implications. *Employee Health, Coping and Methodologies*. (Editors: Pamela L. Perrewe, Daniel C. Ganster), JAI Press, pp.233-266, New York
- Brophy E, Wang Z, She Q, Ward T, 2021. Generative adversarial networks in time series: A survey and taxonomy. <https://doi.org/10.48550/arxiv.2107.11098>
- Chandra R, He Y, 2021. Bayesian neural networks for stock price forecasting before and during COVID-19 pandemic. *PLOS ONE*, 16(7), e0253217. <https://doi.org/10.1371/journal.pone.0253217>



- Cho K, Van Merriënboer B, Gulcehre C, Bahdanau D, Bougares F, Schwenk H, Bengio Y, 2014. Learning Phrase Representations using RNN Encoder-Decoder for Statistical Machine Translation. <https://doi.org/10.48550/arXiv.1406.1078>
- Choi J, Yoo S, Zhou X, Kim Y, 2023. Hybrid Information Mixing Module for Stock Movement Prediction. *IEEE Access*, 11, 28781–28790. <https://doi.org/10.1109/access.2023.3258695>
- Creswell A, Bharath A, 2019. Inverting the generator of a generative adversarial network. *IEEE Transactions on Neural Networks and Learning Systems*, 30(7), 1967–1974. <https://doi.org/10.1109/tnnls.2018.2875194>
- Deng L, Yu D, 2014. Deep Learning: Methods and Applications. *Foundations and Trends® in Signal Processing*, 7(3-4), 197–387. <https://doi.org/10.1561/20000000039>
- Furdui A, Zhang T, Worring M, Cesar P, El Ali A, 2021. AC-WGAN-GP: Augmenting ECG and GSR Signals using Conditional Generative Models for Arousal Classification. <https://doi.org/10.1145/3460418.3479301>
- Goodfellow I, Pouget-Abadie J, Mirza M, Xu B, Warde-Farley D, Ozair S, Courville A, Bengio Y, 2014. Generative Adversarial Nets. *Advances in Neural Information Processing Systems* (Vol. 27). Retrieved from [https://proceedings.neurips.cc/paper\\_files/paper/2014/file/5ca3e9b122f61f8f06494c97b1afccf3-Paper.pdf](https://proceedings.neurips.cc/paper_files/paper/2014/file/5ca3e9b122f61f8f06494c97b1afccf3-Paper.pdf)
- Gulrajani I, Ahmed F, Arjovsky M, Dumoulin V, Courville A, 2017. Improved Training of Wasserstein GANs. *ArXiv*. /abs/1704.00028
- Han B, Jia S, Liu G, Wang J, 2020. Imbalanced Fault Classification of Bearing via Wasserstein Generative Adversarial Networks with Gradient Penalty. *Shock and Vibration*, 2020, 1–14. <https://doi.org/10.1155/2020/8836477>
- Han X, Zheng S, He Z, Huang J, Che L, Li L, 2023. Short-term wind power prediction model based on improved ACA-GRU neural network. *Journal of Physics: Conference Series*, 2527(1), 012078. <https://doi.org/10.1088/1742-6596/2527/1/012078>
- Hochreiter S, Schmidhuber J, 1997. Long short-term memory. *Neural Computation*, 9(8), 1735–1780
- Huang Z, Chen S, Zhang J, Shan H, 2021. PFA-GAN: Progressive Face Aging with Generative Adversarial Network. *IEEE Transactions on Information Forensics and Security*, 16, 2031–2045. <https://doi.org/10.1109/tifs.2020.3047753>
- Ilyas QM, Iqbal K, Ijaz S, Mehmood A, Bhatia S, 2022. A Hybrid Model to Predict Stock Closing Price Using Novel Features and a Fully Modified Hodrick–Prescott Filter. *Electronics*, 11(21), 3588. <https://doi.org/10.3390/electronics11213588>
- Jin X, Zou Y, Huang Z, 2021. An Imbalanced Image Classification Method for the Cell Cycle Phase. *Information*, 12(6), 249. <https://doi.org/10.3390/info12060249>
- Kimura S, Bao Y, 2022. Improvement of SinGAN, a superresolution method by using image segmentation. <https://doi.org/10.12792/icisip2022.030>
- Kossen T, Subramaniam P, Madai VI, Hennemuth A, Hildebrand K, Hilbert A, Sobesky J, Livne M, Galinovic I, Khalil AA, Fiebach JB, Frey D, 2020. Anonymization of labeled TOF-MRA images for brain vessel segmentation using generative adversarial networks. *ArXiv*. /abs/2009.04227. <https://doi.org/10.48550/arxiv.2009.04227>
- Lawi A, Mesra H, Amir S, 2022. Implementation of long short-term memory and gated recurrent units on grouped time-series data to predict stock prices accurately. *Journal of Big Data*, 9(1). <https://doi.org/10.1186/s40537-022-00597-0>
- Lin Y, Liu S, Yang H, Wu H, 2021. Stock trend prediction using candlestick charting and ensemble machine learning techniques with a novelty feature engineering scheme. *IEEE Access*, 9, 101433–101446. <https://doi.org/10.1109/access.2021.3096825>

- Montgomery DC, 2001. Design and analysis of experiments. 5th ed., John Wiley & Sons, USA
- Mauro G, Luca M, Longa A, Lepri B, Pappalardo L, 2022. Generating mobility networks with generative adversarial networks. EPJ Data Science, 11(1), 1-16. <https://doi.org/10.1140/epjds/s13688-022-00372-4>
- Sabuhi M, Zhou M, Bezemer C-P, Musilek P, 2021. Applications of Generative Adversarial Networks in Anomaly Detection: A Systematic Literature Review. IEEE Access, 9, 161003–161029. <https://doi.org/10.1109/access.2021.3131949>
- Saud AS, Shakya S, 2019. Analysis of Gradient Descent Optimization Techniques with Gated Recurrent Unit for Stock Price Prediction: A Case Study on Banking Sector of Nepal Stock Exchange. Journal of Institute of Science and Technology, 24(2), 17–21. <https://doi.org/10.3126/jist.v24i2.27247>
- Shen Y, Yang C, Tang X, Zhou B, 2020. InterFaceGAN: Interpreting the disentangled face representation learned by GANs. <https://doi.org/10.48550/arxiv.2005.09635>
- Soni P, Tewari Y, Krishnan D, 2022. Machine Learning Approaches in Stock Price Prediction: A Systematic Review. Journal of Physics: Conference Series, 2161(1), 012065. <https://doi.org/10.1088/1742-6596/2161/1/012065>
- Villani C, 2009. Optimal transport: old and new, volume 338. Springer Science & Business Media. <https://doi.org/10.1007/978-3-540-71050-9>
- Wang Q, Kang K, Zhang Z, Cao D, 2021. Application of LSTM and CONV1D LSTM Network in Stock Forecasting Model. Artificial Intelligence Advances, 3(1), 36–43. <https://doi.org/10.30564/aia.v3i1.2790>
- Wang S, Zhao C, Huang L, Li Y, Li R, 2023. Current status, application, and challenges of the interpretability of generative adversarial network models. Computational Intelligence, 39(2), 283–314. <https://doi.org/10.1111/coin.12564>
- Xue X, Huang Q, 2023. Generative adversarial learning for optimizing ontology alignment. Expert Systems, 40(4). <https://doi.org/10.1111/exsy.12936>
- Yang W, Zou H, Wang M, Zhang Q, Li S, Liang H, 2023. Mortality prediction among ICU inpatients based on MIMIC-III database results from the conditional medical generative adversarial network. Heliyon, 9(2), e13200. <https://doi.org/10.1016/j.heliyon.2023.e13200>
- Yu J, Lin Z, Yang J, Shen X, Lu X, Huang TS, 2018. Generative Image Inpainting with Contextual Attention. <https://doi.org/10.1109/cvpr.2018.00577>
- Zhang Y, Qu H, Chang Q, Liu H, Metaxas D, Chen C, 2021. Training Federated GANs with Theoretical Guarantees: A Universal Aggregation Approach. <https://doi.org/10.48550/arxiv.2102.04655>
- Zhang Z, Schomaker L, 2022. Optimized latent-code selection for explainable conditional text-to-image GANs. <https://doi.org/10.48550/arxiv.2204.12678>
- Zhou G-B, Wu J, Zhang C-L, Zhou Z-H, 2016. Minimal gated unit for recurrent neural networks. International Journal of Automation and Computing, 13(3), 226–234. <https://doi.org/10.1007/s11633-016-1006-2>

## **HSP90AA1 Gene Polymorphism in Hamdani Sheep**

**Ümit Bilginer<sup>1\*</sup>, Bahar Argun Karışlı<sup>2</sup>, Eymen Demir<sup>1</sup>**

<sup>1</sup>Akdeniz University, Faculty of Agriculture, Department of Animal Science, 07058, Antalya, Türkiye

<sup>2</sup>Eskisehir Osmangazi University, Faculty of Agriculture, Department of Agricultural Biotechnology, 02640, Eskisehir, Türkiye

\*Corresponding author e-mail: ubilginer44@gmail.com

### **Abstract**

*Understanding the genetic basis of heat tolerance in farm animals is crucial, especially for mitigating the adverse effects of climate change. Heat Shock Proteins (HSPs) constitute a group of molecules released under cellular stress conditions such as high temperatures and oxidative stress, playing a vital role in maintaining cellular balance. This study focused on identifying the HSP90AA1 gene polymorphism in 31 unrelated Hamdani sheep bred in the Muş province, employing the Allele-Specific Polymerase Chain Reaction (AS-PCR) technique. It was found that the HSP90AA1 region had two alleles (C and G) and three possible genotypes (CC, CG, and GG) that were polymorphic. The frequencies of the C and G alleles were equal (0.50), while the genotype frequencies were calculated as 0.25 (CC), 0.25 (GG), and 0.50 (CG). Preserving variations in the HSP90AA1 region could provide valuable information for marker-assisted selection studies aiming to enhance heat tolerance characteristics in Hamdani sheep and other livestock breeds. Additionally, these genetic variations could be utilized by farmers to cope with heat stress in indigenous Turkish sheep populations and promote sustainable sheep farming.*

**Keywords:** AS-PCR, Heat Stress, genetics polymorphism

### **INTRODUCTION**

Approximately 10,000 years ago, sheep (*Ovis aries*) domesticated by humans became essential for both human nutrition and the textile industry. Animal husbandry, which plays a crucial role in maintaining human health, is currently threatened by global warming. Climate change leads to increasing temperatures, rising concentrations of carbon dioxide in the atmosphere, droughts, sudden floods, the formation of agroecological zones, and decreased rainfall (Rosenblatt and Schimitz, 2014). These factors are of direct negative impacts on sustainable agriculture, animal welfare, and food security. Various scenarios have been devised to overcome the disadvantages of global warming's direct effects on livestock. One of the most efficient approaches involves increasing the frequency of genotypes tolerant to heat stress within the population (Seijan et al., 2021). Marker-assisted selection (MAS) has made it possible to identify desired genotypes which could be used to improve heat stress in local populations. To do so, animals should be monitored in terms of the genes related to heat stress via advanced molecular genotyping methods. Of these methods, allele-specific polymerase chain reaction (AS-PCR), a commonly preferred approach for detecting genetic polymorphism, is one of the most cost-efficient and applicable techniques allowing for direct detection of any point mutation in the genome.

Heat Shock Proteins (HSPs) are a group of molecules expressed under cellular stress conditions like high temperatures and oxidative stress, offering protective functions vital for maintaining cellular homeostasis. During extreme heat conditions, HSP synthesis occurs in organisms to stabilize the cell's internal environment and uphold cellular function. In animals enduring heat stress, initial responses include heightened rectal temperature, respiration rate, and heart rate, alongside a notable decrease in



feed intake which generally results in declines in economically significant traits such as body weight, milk yield, and reproductive performance (Demir et al., 2022). Additionally, due to their significant role in regulating the immune response, HSPs expose the organism to infections in situations of heat stress, leading to various health issues (Hassan et al., 2019). Singh et al. (2017) highlighted the association of the C allele and CC genotype of SNP4 within the HSP90AA1 gene with thermotolerance parameters, including pulse rate, rectal temperature, and neutrophil/lymphocyte ratio, across four Indian sheep breeds. They underscored the advantageous potential of these genotypes in selection for populations better suited to withstand heat stress. Moreover, they presented a cost-effective and efficient AS-PCR protocol for the identification of such animals. (Singh et al., 2017).

Climate change and desertification pose significant global concerns, with Türkiye and the Middle East region standing out as among the most impacted areas (Bayram and Öztürk, 2021). Projections for Türkiye and nearby countries indicate an anticipated rise in average temperatures by 3-5 °C and a reduction in rainfall by 20% to 40% (Gunay and Ubay, 2007). Despite the significant risks held by global warming, studies focusing on HSP genes in farm animals remain relatively scarce in Türkiye. Moreover, in Türkiye, where approximately 90% of sheep farming is conducted with native sheep breeds, it has been reported that there are over 30 indigenous sheep breeds and their crosses (Kandemir ve Taşkın, 2022). Hamdani sheep, renowned for its fat-tailed attributes and combined productivity, is predominantly reared across geographical regions including Iran, Northern Iraq, and specific areas of Eastern and Southeastern Anatolia in Türkiye, notably including provinces such as Hakkâri, Van, Muş, Siirt, Batman, and Bitlis (Bingöl ve Bingöl 2018). It is estimated that Hamdani sheep constitute approximately 20% of the sheep raised in the Southeastern Anatolia Region of Türkiye (Taşkın ve Kandemir 2022). Due to the fact that significant differences between the summer and winter seasons of the raised areas, Hamdani sheep are expected to be tolerant to both cold and heat stress. Unfortunately, there exists no prior study delving into HSP polymorphisms within the Hamdani sheep population. Hence, this paper attempts to be a pioneer in the detection of polymorphisms in the *HSP90AA1*(112G>C) gene in Hamdani sheep via the AS-PCR technique.

## MATERIAL AND METHODS

### Material

A total of 31 blood samples representing Hamdani sheep were randomly chosen from five different flocks reared in Muş province. The blood samples were collected into vacutainer tubes containing EDTA solution as an anticoagulant from the jugular vein and stored at -20 °C until DNA isolation was performed. A classical salt precipitation protocol was employed to extract DNA from total blood (Miller et al., 1988). The quality and quantity of DNA were assessed using 1% agarose gel electrophoresis and the NanoDrop-SD 1000 spectrophotometer. The DNA concentration was adjusted to 50 ng/µL for PCR amplification.

### Methods

#### *AS-PCR Amplification and Genotyping*

AS-PCR protocol described by Singh et al., (2017) was used to amplify the C and G alleles in the *HSP90AA1* promoter region of the sheep genome. In brief, two primer sets were used to amplify the C and G alleles of 254 base pairs (bp) in the PCR process. Gradient PCR was applied for different annealing temperatures (55 to 65 °C) to optimize PCR conditions where expected fragments were clearly detected at 60 °C. PCR was performed in a 50 µL reaction volume with 50 ng template DNA, 5 µL 10X reaction buffer, 0.6 mM dNTP, 2.5 mM MgCl<sub>2</sub>, 10 pM of each primer, 1 U Taq DNA polymerase (GeNet Bio, Korea) and 31.25 µL nuclease-free water. PCR amplification was performed at 94 °C for

10 min for initial denaturation, followed by 31 cycles of 94 °C for 40 s, 60 °C for 40 s and 72 °C for 40 s. The amplified C and G alleles were visualized by agarose gel electrophoresis to genotype the animals. Individuals with both amplifications were considered heterozygous (GC), while single amplifications genotyped individuals as homozygous (CC or GG) depending on the type of nucleotide amplified.

#### Statistical Analysis

GenAlEx software (Peakall & Smouse, 2012) was employed to compute the frequencies of alleles and genotypes, as well as to assess Hardy-Weinberg equilibrium (HWE) through a chi-square ( $\chi^2$ ) method. Allele and genotype frequencies were determined by directly counting the proportions of various alleles and genotypes, respectively. The chi-square value was calculated using the provided equation below:

$$X^2 = \sum_{i=1}^k \frac{(O - E)^2}{E}$$

where O and E represent the observed and expected number of individuals of the i-th genotype.

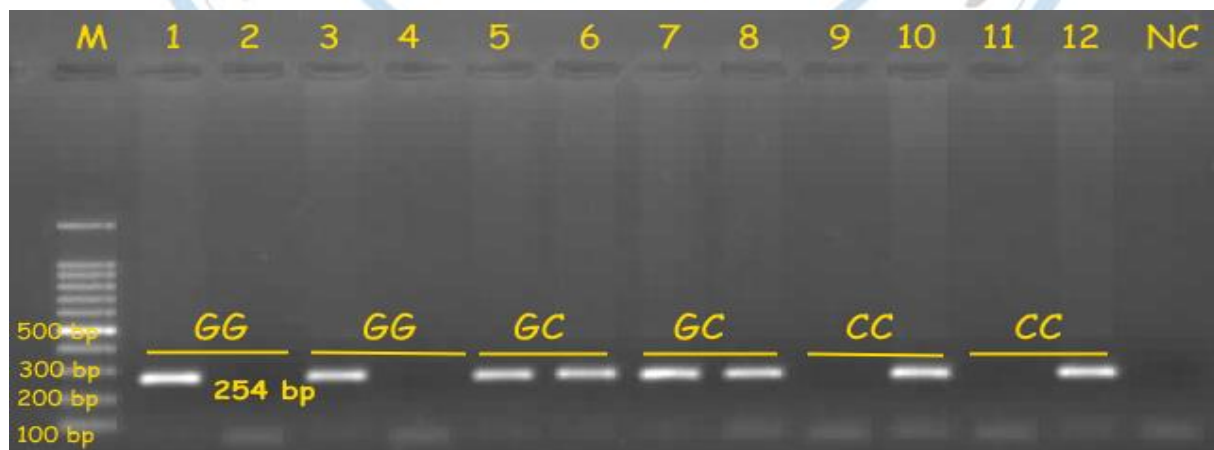
### RESULTS

The C and G alleles in the *HSP90AA1*(112G>C) gene of Hamdani sheep were amplified using the AS-PCR technique, and an agarose gel image is presented in Figure 1. Animals showing both amplifications were recorded as heterozygous (GC), while those exhibiting a single amplification were classified as homozygous (CC or GG). It was observed that the G allele frequency (0.50) and the C allele frequency (0.50) were equal, with genotype frequencies of GG, GC, and CC being 0.25, 0.50, and 0.25, respectively (Table 1). According to the chi-square test, the *HSP90AA1* gene region in the Hamdani sheep population was found to be in Hardy-Weinberg equilibrium.

**Table 1.** Allele and genotype frequencies and chi-square values for *HSP90AA1*(112G>C in Hamdani breed

Breed	n	Allele frequency		Genotype frequency			$\chi^2$
		G	C	GG	GC	CC	
Hamdani	31	0.50	0.50	0.25 (9)	0.50 (13)	0.25 (9)	0.806 <sup>a</sup>

$\chi^2_{20.05;1} = 3.84$ ; a: Deviation from Hardy Weinberg Equilibrium is non-significant.



**Figure 1.** The 2% agarose gel image obtained for the AS-PCR performed for the determination of *HSP90AA1* genotypes in the Hamdani breed (M: Marker (100 bp- Thermo 100 bp; Cat.No: SM0241); NC: Negative control).

## DISCUSSION AND CONCLUSION

The fact of increasing trends in temperatures around the globe force scientists to identify genomic regions related to heat tolerance in different farm animals. Indeed, the selection of heat-tolerant animals is gaining increasing importance, particularly due to extreme environmental factors. In this regard, the *HSP90AA1* gene has gained significance due to playing an important role in heat tolerance as well as allowing for sustainable agricultural production for current and future demands. Previous studies have reported negative effects of heat stress on the thermoregulatory system and physiological changes in animals (Mohalik et al., 2021; Castillo-Salas et al., 2023). For example, Singh et al. (2017) investigated a variation in the *HSP90AA1* gene directly linked to thermotolerance in four local Indian sheep breeds (Chokla, Marwari, Magra, and Madras Red), emphasizing the superior coping abilities of animals with the C allele regarding heat stress parameters (rectal temperature, pulse rate, and neutrophil/lymphocyte ratio). Yurdagül et al. (2023) identified polymorphism in the *HSP90AA1* gene region in the Pırlak sheep, rearing in Antalya, one of the hottest regions in Türkiye, with genotype frequencies of 0.183 (CC), 0.413 (GG), and 0.404 (GC). Furthermore, Demir (2024) found the lowest CC allele frequency in the İvesi breed (0.25) and the highest C allele frequency in the Güney Karaman breed (0.458) among three native Turkish sheep breeds. Compared to previous studies focusing on polymorphism in the *HSP90AA1* gene in several Turkish and Indian sheep breeds, Hamdani exhibited higher C allele frequency (Singh et al., 2017; Yurdagül et al., 2023; Demir et al., 2023). This finding could be explained by the most probably Hamdani is exposed to higher and lower ambient temperatures during summer and winter seasons, respectively. It is noteworthy that a lower sample size may also result in higher C allele frequency by chance factor. It is encouraging that some studies have been recently aimed at screening polymorphisms related to thermo-tolerance in native farm animals such as cattle (Karsli, 2023) and sheep (Yurdagül et al., 2022; Demir et al., 2023) in Türkiye, albeit no studies are available to identify candidate genes to enhance heat tolerance in Anatolian livestock species by using high-density genetic data recovered from advanced molecular genotyping methods such as array technologies and next-generation sequencing (NGS) platforms.

In conclusion, this study represents the first investigation of the *HSP90AA1* gene region related to thermotolerance in Hamdani sheep, where the prevalent presence of the C allele, known to play a significant role in coping with heat stress, has been observed within the population. Given the ongoing severe impacts of climate change, the preservation of this polymorphism within the population will become mandatory in the future. Furthermore, there is a scarcity of studies not only focusing on HSP genes but also elucidating their relationship with molecular characterization and economically important genes in Hamdani sheep. To gain a better understanding of the polymorphism in the *HSP90AA1* gene in Hamdani sheep, it is strongly recommended for further studies to both increase the sample size and investigate its association with phenotypic parameters such as rectal temperature, pulse rate, heart rate, hemoglobin level, and neutrophil/lymphocyte ratio.

## References

- Bayram, H, Öztürk, AB, 2021. Global Climate Change, Desertification, and Its Consequences in Turkey and the Middle East. In: Pinkerton, K.E., Rom, W.N. (eds) Climate Change and Global Public Health. Respiratory Medicine. Humana, Cham. [https://doi.org/10.1007/978-3-030-54746-2\\_21](https://doi.org/10.1007/978-3-030-54746-2_21)
- Bingöl, E, Bingöl, M, 2018. Some growth, reproduction and lactation characteristics of hamdani sheep. *Yüzüncü Yıl Üniversitesi Tarım Bilimleri Dergisi*, 28(2): 161-167.
- Castillo-Salas, CA, Luna-Nevárez, G, Reyna-Granados, JR, Luna-Ramirez, RI, Limesand, SW, Luna-Nevárez, P, 2023. Molecular markers for thermo-tolerance are associated with reproductive and physiological traits in Pelibuey ewes raised in a semiarid environment. *Journal of Thermal Biology*, 112(103475): 1-12.



- Demir, E, Ceccobelli, S, Bilginer, U, Pasquini, M, Attard, G, Karsli, T, 2022. Conservation and selection of genes related to environmental adaptation in native small ruminant breeds: a review. *Ruminants*, 2(2): 255-270.
- Gunay, A, Ubay, B, 2007. First National Communication of Turkey on Climate Change. Ministry of Environment and Forestry, Turkey. [http://www.dsi.gov.tr/docs/iklim-degisikligi/iklim\\_degisikligi\\_%C4%B1\\_ulusal\\_bildirim\\_eng.pdf?sfvrsn=2](http://www.dsi.gov.tr/docs/iklim-degisikligi/iklim_degisikligi_%C4%B1_ulusal_bildirim_eng.pdf?sfvrsn=2). English.
- Hassan, FU, Nawaz, A, Rehman, MS, Ali, MA, Dilshad, SM, Yang, C, 2019. Prospects of HSP70 as a genetic marker for thermo-tolerance and immuno-modulation in animals under climate change scenario. *Animal Nutrition*, 5(4): 340-350.
- Kandemir, Ç, Taşkin, T, 2022. Doğu Anadolu Bölgesinde Yetiştirilen Koyun Irklarının Mevcut Durumu. *Hayvansal Üretim*, 63(1): 57-66.
- Karlı, BA, 2024. HSP90AB1 (SNP-4338T> C) gene polymorphism associated with thermo-tolerance in some cattle breeds in Türkiye. *Mediterranean Agricultural Sciences*, 37(1): 51-55.
- Mohalik, PK, Sahoo, SS, Mishra, C, Dash, SK, Nayak, G, 2021. Novel polymorphism of HSP70 gene affected caprine physiological vital parameters. *Animal Biotechnology*, 32(5): 550-557.
- Sanil-Kumar, BV, Kumar, A, Kataria, M, 2011. Effect of heat stress in tropical livestock and different strategies for its amelioration. *Journal of Stress Physiology & Biochemistry*, 7(1): 45-54.
- Sejian, V, Silpa, MV, Lees, AM, Krishnan, G, Devaraj, C, Bagath, M, Anisha, JP, Reshma-Nair, MR, Manimaran, A, Bhatta, R, Gaughan, JB. 2021. Opportunities, challenges, and ecological footprint of sustaining small ruminant production in the changing climate scenario. *Agroecological Footprints Management for Sustainable Food System*, 365-396.
- Yurdagül, KG, Atay, S, Bilginer, U, Karsli, T, Demir, E, 2023. Genetic variations in HSP90AA1 gene region in Pırlak sheep breed. *Hayvansal Üretim*, 64(1): 12-16.

#### **Conflict of Interest**

The authors have declared that there is no conflict of interest.

#### **Author Contributions**

UB conceptualized the study and designed the research, while ED performed laboratory and statistical analyses. BAK contributed to the development of the methodology and the writing of the manuscript. All authors reviewed and approved the final version of the manuscript.

## Farmers' Perception and Willingness to Pay For Early Warning Climate System in Albania. The Case of Wheat/Corn Crops in the Area of Korce and Fier

Irida GJERMENTI<sup>1\*</sup>

<sup>1</sup>University of Agriculture of Tirana, Koder Kamez, Tirana, Albania

\*Corresponding author e-mail: igjermeni@ubt.edu.al

### *Abstract*

*This study highlights the perception and the need for an early warning climate system that the farmers of Korce/Fieri have. Of the farmers sampled, only 83.5% have access to climate information. About 45.5% of farmers are willing to pay an average of 23,618 Lek to benefit from an early weather forecast system.*

*Willingness to pay is determined by farmers' ability to predict the climate, to use TV/Smart Phone applications as an information tool, farmers' awareness of the risks of changing climate conditions. Farmers perceive that periods of drought have increased, and rainy days have decreased, increasing the range of plant diseases.*

**Keywords:** farmers, early warning climate system, willingness to pay

### **1. Introduction**

Agriculture is considered a very sensitive sector to the climate in Albania. This sector contributes 22.6% to its GDP and is the main source of employment for the country's rural population. This sector has experienced moderate growth over the past decades, structural challenges, such as underdeveloped infrastructure and the lack of effective irrigation networks, have hindered its wider development.

Studies show an increase in temperature as well as variability in precipitation. The increase in extreme weather events is also likely to pose a serious threat to agricultural production, water availability, economic growth for the majority of the rural population that depend directly or indirectly on agriculture. In particular, those areas that are already under marginal rain-fed production will be increasingly at risk. Direct impacts on agricultural production are also combined with effects such as: soil characteristics, seed genetics, pests and diseases, inefficiency of agronomic practices, which ultimately affect crop yield (Kopali & Libohova et al. 2017).

The increase in temperatures and the increase in rainfall fluctuations are expected to have a negative impact on the agricultural sector and the economy in general. Changes in rainfall patterns and intensity may lead to more frequent flooding in key agricultural areas (FAO 2018)

Global warming changes the climatic adaptability of plant species and extreme weather, including high temperatures, rainstorms and floods, results in loss of crop yields (Stott et al 2016).

Providing climate information services (CIS) is one of the main ways in which farmers can deal with climate change and variability in order to improve decision-making in agriculture. Climate services can be understood as activities related to the generation and provision of climate information to a wide range of users in order to support climate resilient development. Climate services include the production, translation, transfer and use of climate knowledge and information in climate-informed decision-making and climate-smart policy and planning. Climate information prepares users for the weather they actually experience. In agriculture, climate and weather data are combined with non-meteorological data, such as agricultural information to produce agro-pest advisories. The sensitivity of the agricultural sector to the climate as well as the great dependence of this sector on rainfall and water resources. have wide implications for Albania. Making Albania's agricultural sector more resilient to climate change will require additional investment to increase access and use of technology by farmers as well as the dissemination of hydro meteorological information. Although Albania is one of the country's most at

risk from climatic conditions, there is no early warning system in any of its sectors. The only study found for this term in Albania is that of the World Bank for the profile of Albania.

Different adaptation strategies have been implemented in different countries of the world to reduce the vulnerability of smallholder farmers to climate risks in different contexts. One prominent method is the use of early warnings for extreme climate and weather events. Early warning systems (EWS) on smallholder farms are essential for adaptation to climate variability and change.

Natural hazard warning systems include detection, analysis, prediction, and then warning distribution followed by response decision-making and implementation (Mileti, 1999; Sorensen, 2000; Basher, 2006; Glantz, 2009; Bernard et al., 2006). EWSs include a set of capabilities to generate and deliver timely incentives that enable individuals, communities and organizations to prepare and take action to mitigate climate-related harm or loss (Glantz, M.H & Baudoin, M & Ahmed, A.K & Tozier, A. & Poterie, D. & Naranjo, L. & Pradhananga, D & Wolde-Georgis, T. & Fakhrudin, B. & Berhane, M. A et al. 2014)

Willingness to pay expresses the maximum amount that an individual is willing to sacrifice to secure a good or service. According to Miller et al. (2011) there are many methods to measure willingness to pay and these methods can be differentiated depending on the measurement, whether it is direct or indirect and whether the measurements are hypothetical or actual. The direct method is done by asking respondents to state directly how much they are willing to pay for a particular product or service, for example, with an open-ended question format. While the indirect method, it is carried out through choice-based analysis, in which the willingness to pay is calculated based on the individual's choices among several alternatives.

## 2. Literature Review

Agricultural information systems have been defined as an information system in which agricultural information is generated, transformed, and consolidated with the intention of underpinning knowledge utilization by agricultural producers (de Oliveira, Painho, Santos, Sian, & Barriguinha et al 2014). The AIS consists of subsystems, processes, mechanisms and system operations (Vidanapathirana et al. 2012). The users of AIS could include the government decision makers, policy makers, universities, researchers, extension workers, and farmers (Vidanapathirana et al. 2012).

The analysis of the agricultural information system in a specific farming system may provide the identification of basic components and structure of the system, the different sources of information used by different components in the system, the understanding of how successfully the system works and how to improve system performance (system management) (Demiryurek, 2000).

The analysis of the agricultural information system in a specific farming system may provide the identification of basic components and structure of the system, the different sources of information used by different components in the system, the understanding of how successfully the system works and how to improve system performance (system management) (Demiryurek, 2000).

The analysis of the agricultural information system in a specific farming system may provide the identification of basic components and structure of the system, the different sources of information used by different components in the system, the understanding of how successfully the system works and how to improve system performance (system management) (Demiryurek et al. 2000).

Agricultural innovation can lead to reduction in poverty through direct and indirect effects (Berdegue & Escobar et al. 2001). Agricultural Information Systems (AIS) can help meet farmers' information needs, including agricultural inputs, education on extension programs, knowledge on agricultural technology, credit programs, and marketing information (Lu, Pan, Lu, Qin, & Wang et al. 2015). One of the examples of direct effects is through the adoption of new technologies, which can improve the income of the farmers when they reduce the marginal cost of producing one unit of output (Berdegue & Escobar et al. 2001). Indirect effects of technology on poverty reduction include the benefits of lower



food prices because of higher agricultural productivity, and the increased employment (Berdegue & Escobaret al. 2001).

Rapid technological advances in the mobile field are expected to increase the speed of data collection, analysis and dissemination, further expand the range and usability of m-services in agriculture in the future (Baumüller, 2017) and use information sharing (crowdsourcing) and other systems based on the collective and voluntary exchange of price and non-price information (transportation, weather forecasting, market operators, technology information, availability of farm inputs and other prices as mentioned by Amer et al. (2018). On the other hand, technology adaptation and low awareness among users can reduce the usability of the systems and undermine the financial feasibility (Juma et al, 2017; Steinke et al, 2021).

As a result of this dichotomy, the literature has not developed equally. There is an extensive literature that highlights the importance of market information systems in helping smallholder farmers in countries with a weak contract farming presence to make better decisions by reducing information asymmetries and building trust (CTA, 2005). But there are few studies that assess the opportunities for farmers to access and use agricultural market information which may include poor infrastructural links, high costs to access information, low level of trust in information sources and information quality, low informational knowledge and insufficient support from government agencies and agricultural advisory (Amer et al., 2018). In addition, there is very limited research to explore the main reasons related to the institutional failures of AMIS or the cognitive factors of farmers and market actors that prevent the use of AMIS (FAO, 2015) and on the preferences of users towards AMIS: Very few studies explore their willingness to pay for the information service (Kenkel and Norris, 1997; Parker et al, 1996; Cohen and Zilberman, 1997) but the whole area relates to the first generation AMIS. In Albania, the only study was conducted by Zhllima et al (2022), which assessed WTP for information, but did not examine the factors influencing it or farmers' commitment.

Research in Information and Communication Technology for Development (ICTD), a recently developed field of research, is both observational and applied. A quasi-participatory approach of observing the basic use and applications of existing ICTs allows a rich understanding of the gaps facing the developing world (Kenkel and Norris, 1997). In the case where the type of information is diverse and the interests of users are oriented to the pluralism of crops, a large survey-based observation is required. The use of structured surveys is lacking in developing countries. Very few are comprehensive in exploring willingness to pay and user preference, as is the case of contingent assessment of demand for weather information (Kenkel and Norris, 1997). Furthermore, although there are some studies that evaluate crowdsourcing, no study evaluates the farmer's willingness to participate or contribute to crowdsourcing, whether or not they are financially rewarded for their work. (Schenk & Guittard, 2011). The theory of planned behavior (Ajzen, 2011), the theory of rational expectations and the theory of agency will be operationalized for the evaluation of farmers' behavior towards information exchange (crowdsourcing). As the data collection is based on the voluntary exchange of information (in situ Minet et al, 2017), there is no collective action analysis for the users or beneficiaries of this system. Moreover, the literature does not show whether the monetary value of the use of time for the provision of data is evaluated and compared with the potential benefit perceived by farmers as an exchange for information, such as the case of advisory services, market information services, production evaluations (Minet et al, 2017). Exploratory analyzes are used by very few authors (Reed et al., 2013) to assess farmers' motivation.

The literature review and research background help to understand that Agricultural Information Systems suffer sustainability due to lack of long-term user evaluation and support. Their use as a public good in a country with institutional instability reduced foreign donor aid and low trust in agricultural

service systems brings various shortcomings. Thus, it is advisable to find forms of support for Information Systems through (directly or indirectly from users).

The overall objective of the research work is to explore the demand of farmers in Albania for agricultural information system. The objectives of the subject are

- a. To assess farmers' preferences for agricultural information by type, including weather, production technology, information on inputs, information on services such as transport, insurance, credit and counseling, prices
- b. To identify the characteristics of farmers who require agricultural information.
- c. To evaluate their willingness to pay (WTP) according to the type and attribute of agricultural information (reliability of market partners, price information, quality of information)
- d. To measure the willingness of farmers to participate or adopt crowdsourcing (information provided voluntarily in exchange of information of other farmers with a focus on weather forecast data) and the factors influencing this willingness.
- e. To assess farmers' perception and trust in existing or potential sources of agricultural information by types of information.
- f. To offer recommendations regarding requests for information systems and the possibility that farmers have for private agricultural information.

Having a clear focus of the analysis, the question posed is what are the factors that influence the demand of farmers and other operators for agricultural information and what is their willingness to support or to be involved as information providers? The answer to this question helps to reveal the institutional conditions in which enterprises should be supported for the establishment of agricultural information systems in the future with the help of ICT. A series of questions can be asked which help to answer the following research questions:

- What types of agricultural information do farmers have the most demand for?
- How do farmers evaluate and perceive the quality, reliability and nominal value of this information?
- What were the previous information systems from farmers?
- Are farmers willing to pay any agricultural information provider and how is this willingness seen according to the types of information?
- What are the main factors affecting willingness to pay?
- What would be the methods and actors responsible for providing agricultural information according to farmers, assessing their perception and reliability?
- Are farmers willing to offer their voluntary data collection efforts such as prices, disease occurrences, climate data, or similar phenomena (crowdsourcing) to exchange agricultural information?

Although more other research questions arise, since the lack of studies in Albania on this topic leaves a lot of room for study, it seems impossible to expand this paper more due to the very conditions and limitations that this field of study presents in the field. Also, the extension to other questions will complicate the study and will create a deviation from the focus of the central research problem.

### 3. Materials and Methods

#### 3.1. Study Area

Fieri, like the whole of Albania, belongs to the Mediterranean climate zone, and is distinguished by more pronounced Mediterranean features, which are characterized by hot and dry summers with great sunshine and mild winters with heavy rainfall. Frost and snow are extremely rare occurrences. The heat starts from the middle of spring and continues until the end of October. The climate of Fieri is warm because Fieri is wet by the sea and is protected from the east by cold winds. Fieri stands out for the high number of sunny days, the maximum reached 3700 hours per year, or with an average of 2800 hours. Rainfall has a very irregular time regime, they are mainly concentrated in the cold half of the year, their average amount reaches 980–1000 mm/year. Summer in Fier is dry and often it doesn't rain for weeks. The wettest months are November and January, and the driest months are July and August. The winds blow in different directions, but during the winter the south wind prevails, which brings heavy rains, while during the summer the wind blows from the north and northwest. The proximity to the sea means that the climate is mild and only in very rare cases the temperatures drop below zero. The average annual temperature ranges from 15°C–16 °C. The climate of Fier allows the development of a multi-branched agriculture. Also, agricultural lands can be used 2-3 times a year.



Korça has the second largest agricultural sector in Albania, making this sector the most important for the region's economy with a total volume of income of 32%. Korça has a continental Mediterranean climate with large variations in temperature. The hottest month is August (25 °C) while the coldest month is January (2 °C). On average, 710 mm of rain falls during the year, which reaches the minimum in summer and the maximum in winter, making Korça a dry city compared to the rest of Albania. Temperatures in Korça that absorb 2300 hours of solar radiation. Korça has cold winters full of rain and average summers rarely with rain. The diameter of the ridges in the crust is 7.5 cm. Korça has an average maximum temperature of around 15.7°C and an average minimum temperature of 5.7°C. In 2022, the production of cereals is 690,854 tons. The highest level was recorded in Fier County with 171,017 tons, followed by Elbasan and Korçë counties with 95,376 tons and 81,092 tons.



#### 3.2 Data Collection

The data were collected using a structured questionnaire that refers to the socio-economic characteristics of farmers, production factors/Typology of the farm, perceptions towards climate change, sources of information.



The questionnaire was built based on the Contingent Valuation (CVM) which is a stated preference method (survey) in which respondents are asked to state their preferences in hypothetical or conditional markets, allowing analysts to estimate requests for goods or services that are not traded in markets. Generally, the survey is based on a sample of individuals who are asked to imagine that there is a market where they can buy the goods or services being evaluated. Individuals state their maximum WTP for a change in the provision of the good or service, or their minimum trade-off (WTA) if the change is not made. Socio-economic characteristics of respondents such as gender, age, income, education and demographic information will also be taken. If it can be shown that individuals' preferences are not random, but rather vary systematically and are conditioned by some observable demographic characteristics, then population information can be used to predict total WTP for the good or service being evaluated.

Data collection was also related to farmers' perceptions of climate change, and WTP.

According to this database, there were 176 farmers located in 64 villages surveyed from July to September 2023 in the areas of Korce and Fier, as well as Belsh. In each village, farmers were randomly selected for the survey.

### 3.3 Data Analysis

The chi-square test was used to compare farmers' perception of climate forecasts and potential users' socioeconomic characteristics at significance level  $p = 5\%$ .

The test statistic for the Chi-Square Test of Independence is denoted  $X^2$ , and is computed as:

$$\chi^2 = \sum_{i=1}^R \sum_{j=1}^C \frac{(o_{ij} - e_{ij})^2}{e_{ij}}$$

Where:

$o_{ij}$  is the observed cell count in the  $i^{\text{th}}$  row and  $j^{\text{th}}$  column of the table

$e_{ij}$  is the expected cell count in the  $i^{\text{th}}$  row and  $j^{\text{th}}$  column of the table, computed as

$$e_{ij} = \frac{\text{row } i \text{ total} * \text{col } j \text{ total}}{\text{grand total}}$$

The quantity  $(o_{ij} - e_{ij})$  is sometimes referred to as the *residual* of cell  $(i, j)$ , denoted  $r_{ij}$ .

The calculated  $X^2$  value is then compared to the critical value from the  $X^2$  distribution table with degrees of freedom  $df = (R - 1)(C - 1)$  and chosen confidence level. If the calculated  $X^2$  value  $>$  critical  $X^2$  value, then we reject the null hypothesis.

We are using the EFA analysis to build a categorization of the farmers' perceptions of the climatic phenomena that have occurred in their area during the last 10 years.

For cases that Chi-square test report a positive relation between dependent and independent variable, and independent variable was grouped in three or more groups, we are using One-Way ANOVA to see if there are significant differences between group means of dependent variable (WTP or amount of WTP).

The One-way ANOVA test was used to see if there are significant differences in amount of WTP for early warning climate system and agricultural income level. ANOVA is a statistical method to test the null hypothesis ( $H_0$ : there are no significant differences in amount of WTP for early warning climate system and agricultural income level groups) that three or more population means are equal vs. the alternative hypothesis ( $H_a$ : there are significant differences in amount of WTP for early warning climate system and agricultural income level groups) that at least one mean is different. Using the formal notation of statistical hypotheses, for  $k$  means we write:

$$H_0: \mu_1 = \mu_2 = \dots = \mu_k$$

$H_a$ : not all means are equal

where  $\mu_i$  is the mean of the  $i$ -th level of the factor.

Logistic regression model was used to analyze the determinants of farmers' WTP. Logistic regression model is one of the generalized linear models (GLM). It is a model for WTP binary variable where the response records either success or failure for a given event (Hosmer & Lemeshow & Sturdivant et al 2013)

$$p_i = f(y|x) = \frac{1}{1 + \exp\{-(\beta_0 + \beta_1 x_i)\}} \quad (1)$$

where  $p_i$  is the probability of success and,  $P(y_i=1)=p_i$  and  $P(y_i=0)=q_i=1-p_i$ ,  $0 \leq p_i \leq 1$ .

Also,  $\beta_0$  and  $\beta_1$  are the parameters of the model,  $x_i$  is an independent variable,  $\exp$  is the mathematical constant called Euler's number which approximately equal to 2.78.

Logistic regression can be extended to combine more than one independent variable, which can be continuous or categorical variables. The multiple logistic regression model can be then written as:

$$p_i = \frac{1}{1 + \exp\{-z_i\}} = \frac{\exp\{z_i\}}{1 + \exp\{z_i\}} \quad (2)$$

where,  $z_i = \beta_0 + \beta_1 x_1 + \beta_2 x_2 + \dots + \beta_n x_n$  and  $p_i/(1-p_i) = (1 + \exp\{z_i\}) / (1 + \exp\{-z_i\}) = \exp\{z_i\}$ . where,  $p_i/(1-p_i)$  is the odd ratio defined as the probability of occurrence the event divided by the probability of not occurrence the event. The odd ratio is a solution of the upper and lower limits for the probability where,  $0 < \text{odd ratio} < \infty$ .

$$p_i = \frac{\text{odds}}{1 + \text{odds}} = \frac{\exp\{\beta_0 + \beta_1 x_1 + \beta_2 x_2 + \dots + \beta_n x_n\}}{1 + \exp\{\beta_0 + \beta_1 x_1 + \beta_2 x_2 + \dots + \beta_n x_n\}} \quad (3)$$

$$\text{logit} = \ln(\text{odds}) = \ln(p_i/1-p_i) = z_i \quad (4)$$

$$\text{logit} = \beta_0 + \beta_1 x_1 + \beta_2 x_2 + \dots + \beta_n x_n, \quad -\infty < \text{logit} < \infty \quad (5)$$

Therefore, logit is a linear function in independent variables  $x_j, 1 \leq j \leq n$  (Fosdal et al 2017)

- Maximum likelihood estimation

The maximum likelihood (ML) is considered the most widely method used to estimate the parameters in linear regression models. Maximum likelihood estimation is used to estimate the parameters of the logistic regression models. The maximum likelihood method selects the values of parameters of the model that maximize the likelihood function.

The likelihood function of the proposed model is given by:

$$L(\beta, y|x) = p^{y_i} (1-p_i)^{1-y_i} \quad (6)$$

Therefore, the log-likelihood function is obtained as:

$$l(\beta, y|x) = \ln L(\beta, y|x) = \sum_{y=1} \ln p_i + \sum_{y=0} \ln (1 - p_i) \quad (7)$$

The MLE is the value of parameter  $\beta$  that maximizes the log-likelihood function (7) which is given by solving the following equation using the Newton-Raphson technique (Fosdal et al 2017):

$$\partial l(\beta, y|x) / \partial \beta = 0 \quad (8)$$

- Evaluation of the fitted model

Several tests are involved to assess the usefulness, convenience, and sufficiency of the fitted model. The importance of each of independent variables is evaluated by testing the significance of the coefficients. Then, the goodness of fit of the model is investigated.

1. Statistical tests for the parameters

The *Wald statistic test* is used to test the significance of individual coefficients in the logistic regression model. The Wald test is given as follows (Fosdal et al 2017):

$$\text{Waldstatistic}=(b/\text{se}(b))^2 \quad (9)$$

where  $b$  is the estimated parameter of  $\beta$  for the independent variable,  $\text{se}$  is the standard error of  $b$ . The null hypothesis  $H_0$ : the effect of logit parameter is equal to 0 is tested against the alternative hypothesis  $H_1$ : the effect of logit parameter is not equal to 0.

*Likelihood ratio test* for a particular parameter compares the likelihood function (6) when the parameter is zero ( $L_0$ ) with the likelihood function ( $L_1$ ) when the parameter is estimated by MLE. The test statistic is obtained as follows:

$$-2 \times \ln(\text{likelihoodratio}) = -2 \times \ln(L_0/L_1) = -2 \times (\ln(L_0) - \ln(L_1)) \quad (10)$$

Likelihood ratio statistic follows Chi-square  $X^2$  distribution with one degree of freedom (Fosdal et al 2017)

2. Goodness of fit of the model

The goodness of fit of a statistical model describes how well the model fits the observed data and describes the dependent variable. Evaluating the goodness of fit involves inspecting how close predicted values are to the observed values.

The Hosmer–Lemeshow statistic is used to assess the goodness of fit of logistic regression model and allows for any number of independent variables; either quantitative or qualitative. It determines whether the differences between observed and expected proportions are significant. The Hosmer–Lemeshow test is like a  $X^2$  goodness of fit test but it has the advantage of dividing the observations into various groups have approximately equal size, and therefore there are less likely to have groups with very low frequency of observed and expected values. The observations are grouped into deciles based on the expected probabilities. The Hosmer–Lemeshow statistic follows  $X^2$  distribution with degree of freedom ( $D-2$ ) and it is given by the following equation

$$HL = \frac{\sum_{d=1}^D (O_{1d} - E_{1d})^2}{N_d \tau_d (1 - \tau_d)} \quad (11)$$

where,  $D$  is the number of groups,  $O_{1d}$  is the number of observed  $Y = 1$  events,  $E_{1d}$  is the number of expected  $Y = 1$  events,  $N_d$  is the total number of observations, and  $\tau_d$  is the estimated risk for the  $d$ -th groups (Hosmer & Lemeshow & Sturdivant et al 2013).

Table 1. Predictors of farmers’ need and WTP for early warning climate system

Variables	Description	Assumptions	Expected effect on WTP
Age	Age of the farmer	Young farmers have more access to information compared to older farmers (Diederer, Van, Arjan, & Katarzyna, 2003).	+
Education	Education of the farmer	The training of farmers promotes the adoption of agricultural innovations (He, Cao, & Li, 2007). Educated farmers are supposed to be more interested in the of climate information compared to the illiterate ones.	+
Experience	Farmer experience	An increase in the number of years that an individual has been engaged in agricultural activities causes a 7% increase in the probability that the farmer has access to climate information. (Antwi-Agyei & Amanor & Hogarh & Dougill et al. 2020)	+
Farm size	Size of farm in HA	Household income and farm size were found to be factors considered by users when deciding	+



**V. International Applied Statistics Congress (UYIK - 2024)**  
**Istanbul / Turkey, May 21-23, 2024**

		how much they were willing to pay for monthly weather information. (Awolala & Mutemi & Antwi-Agyei & Taylor & Muita & Bosire & Mutai & Nkiaka et al.2023).	
Incomes	Incomes of farm	Farmers with large farm sizes and higher farm incomes show interest in paying higher prices while mobile phone distribution channel and farm location specific weather information were the main factors influencing how much farmers would be willing to pay for improved weather information services (Awolala & Mutemi & Antwi-Agyei & Taylor & Muita & Bosire & Mutai & Nkiaka et al.2023). Farmers are interested in and use the climate information but they will be reluctant to sell their produce to pay for it.	+/-
Market orientation		Market orientation is expected to positively influence willingness to pay for CIS. This is due to the fact that income from the sale of plant products has a positive impact on income and on the other hand income has a positive impact on WTP for CIS (Ouédraogo & Barry & Zougmore & Partey & Somé & Baki et al. 2018)	+
Information source channels	Source of information that farmer use to predict weather forecast	For Lugen et al.2019, usability and communication channels (radio, TV, farmer-based organizations, churches, mosques) of climate information services were important in assessing their needs.	+
Impacts of climatic conditions	Likert scale information that measure the impact of each climate change in farmer productivity cycle	Information on the date of the beginning of the rainy helps to choose the planting date (Traore et al., 2014). It is supposed to encourage farmers' WTP for climate information. Information on date of the end of rainy season indicates the beginning of the harvest. It help choose varieties based on their cycle (Traore et al., 2014). It is supposed to encourage farmers' WTP for climate information. Information on the during of the rainy season helps to choose types of varieties based on their cycle (Traore et al., 2014). It is supposed to encourage farmers' WTP for climate information.	+

Note. + expected positive effect; - expected negative effects.

Source: Own elaboration.

#### **4. Results and Discussion**

##### *4.1 Profile of Farmers Potential Users of Early warning climate system*

We found that characteristics of farmers interested in EWCS are not similar between regions ( $p = 0.001$ ) (Table 2). Indeed, the analysis revealed that the majority of EWCS potential users were found among young farmers (21.15%), educated farmers (General technical high school and others (14.5%) and Compulsory education (up to 9 years) (23.3%)). Furthermore, we shown from the results of table 2 that there is no relationship between the crop planted ( $p > 0.05$ ), the type of employment ( $p > 0.05$ ) and the need to use EWCS.

Table 2. Profile of the farmers potentially using of EWCS using Chi-Square Tests

Variables	WTP for early warning climate system		p-value
	Yes	No	
<b>Age</b>			0.007
Young (%)	21.15	16.7	
Old (%)	21.15	41	
<b>Education</b>			0.002
Primary school (4 years)(%)	0	3.8	
Compulsory education (up to 9 years)(%)	23.3	42.1	
Agricultural secondary school(%)	0.6	1.3	
General technical high school and others(%)	14.5	7.5	
Non-agricultural university education(%)	1.9	0	
Diploma of agricultural university education(%)	2.5	2.5	
<b>Employment</b>			0.36
Employment in the public sector(%)	1.9	0.6	
Self-employed in the non-agricultural sector(%)	1.3	0.6	
Self-employed in the agricultural sector(%)	39.7	55.3	
Unemployed(%)	0	0.6	
<b>Regions</b>			0.001
Korce(%)	30.3	13.1	
Fier(%)	10.3	26.9	
Belsh(%)	2.9	16.6	
<b>Culture</b>			
Maize(%)	42.6	56.8	0.25
Grain(%)	40.9	56.3	0.092

Source: Own elaboration

#### 4.2 Farmers' Current Access and perceptions on climate conditions

A large majority (31.8% able to pay and 51.7% not able to pay) of farmers expressed awareness of climate changes in last 10 years (Table 3). Despite this asymmetry, the information sources were not significantly different among farmers ( $p=0.082 > 0.05$ ). Nearly 20.2% of the farmers in the sample received the forecast information by listening to radio/TV.

Table 3. Farmer's awareness toward climatic phenomena and source of information access using Chi-Square Tests

Variables	WTP for early warning climate system		p-value
	Yes	No	
<b>Information source</b>			0.082
Radio/Tv(%)	20.2	33.7	
Phone applications(%)	14.7	17.1	
Extensions/NPO/other(%)	8.1	6.2	
<b>Awareness</b>			0.002
Yes(%)	31.8	51.7	
No(%)	11.4	5.1	

The perceptions expressed by farmers for climate information showed that they are really aware of climate risks on agricultural production (Tarhule & Lamb, 2003; Roncoli et al., 2008). From the answers, it was noticed that in the last 10 years, farmers have perceived high changes in the occurrence of natural events, such as the increase in the period of drought (58.3%), the decrease in the number of

days with precipitation (56.9%) and the increase in days with high temperatures (54.9%). Farmers are the most direct victims of drought, with the reduced crop yields cause huge economic losses that have catastrophic effects on the livelihood security of rural families (Zhang & Shi & Singh & Wang & Liang et al 2022, Keshavarz & Maleksaeidi & Karami et al 2017, Nasrnia & Ashktorab et al 2021, Ahmad & Yaseen & Saqib et al 2022). A rise in high temperatures during the growing season decreases total factor productivity. Particularly, an increase in the share of growing season hours with temperatures above 35°C decreases decreases total factor productivity at the farm level. Further results show that high temperatures decrease yields but not the value of agricultural production at the farm level as in response to a rise in extreme temperature, farmers increase their farming acreage (Mayorga, Joaquin & Villacis, Alexis & Mishra, Ashok et al 2023).

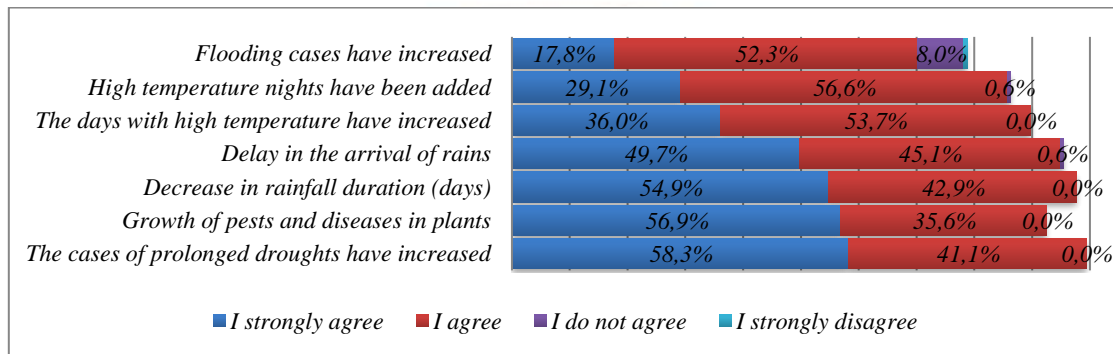


Figure 1. Farmer's perceptions towards climate change in the last 10 years

An EFA was performed using a principal component analysis and varimax rotation. The minimum factor loading criteria was set to 0.50. The communality of the scale, which indicates the amount of variance in each dimension, was also assessed to ensure acceptable levels of explanation. The result show that all communities were over the 0.50.

An important step involve weighing the overall significance of the correlation matrix through Bartlett's test of the Sphericity, which provides a measure of the statistical probability that the correlation matrix has significant correlation among some of its components. The results were significant,  $\chi^2(n=176) = 357.22 (p < 0.001)$ , which indicates its sustainability for factor analysis. The Kaiser-Meyer-Olkin measure of sampling adequacy(MSA), which indicates the appropriateness of the data for factor analysis, was 0.736. In this regard, data with MSA values above 0.7000 are considered appropriate for factor analysis. Finally, the factor solution derived from this analysis yielded three factors for the scale, which accounted for 73.049% of the variation in the data.

Table 4. EFA Results

Items	1	2	3
F1.1 - The cases of prolonged droughts have increased	.917		
F1.2 - Decrease in rainfall duration (days)	.856		
F1.3 - Growth of pests and diseases in plants	.687		
F1.4 - Delay in the arrival of rains	.646		
F2.1 - The days with high temperature have increased		.802	
F2.2 - Flooding cases have increased		.695	
F3.1 - High temperature nights have been added			.885

Source: Own elaboration

The three factor identified as part of this EFA aligned with the theoretical propositions in the research. Factor 1 includes item F1.1 to F1.4. Factor 2 gather items F2.1 and F2.2 and factor 3 was represented only from one item F3.1. Factor loading are presented in table 4.



4.3 Farm typology affecting WTP value for early warning climate system

The results of Table 5 show that there is a relationship between the % of income that the farmer generates from the crop and WTP for early warning climate system ( $p=0.024<0.05$ ). If we analyze the group of farmers who provide more than 90% of the family income from the main crops, we notice that the % of those who want to pay for early warning climate system is greater (8.61%) than those who do not want to pay in this group (4.11%).

The principal assumption upon which the theory of consumer behavior is built is that a consumer is rational and attempts to allocate his/her limited money or income among available goods and services in order to maximize his/her utility (satisfaction). In other words, an individual seeks to maximize utility of a good (in this case climate information services) subject to a given constraint. It is assumed that every farmer pursues the objective of maximizing utility, but each farmer has his/her own perception of utility and constraints and makes willingness to pay decisions based on the unique attributes of his/her own situation (Gebremariam & Edriss & Maganga & Terefe et al 2013). Thus, the WTP for climate information services is assumed to depend upon the set of attribute values that apply to the particular household.

From the result of Table 5, it is also observed that there is a relationship between the cultivated surface and the possibility to WTP for early warning climate system. The connection between planted area and WTP is limited by the cultivated crop. There are a relation between area cultivated with Wheat and WTP ( $p<0.001$ ), also there was a relation between cost/dynym and WTP, not dependable by cultivated plant (*Maize*: $p=0.028<0.05$  and *Wheat*: $p<0.001$ ).

If the destination of the crop is the market (>90%), an increase in the farmer's willingness to pay can be seen. For wheat, there is a relationship between the production destination and WTP ( $p=0.006<0.05$ ), while in the case of maize we do not observe a stability( $p=0.628>0.05$ ). The highest % of farmers are those whose Wheat (21.7%) /Maize (38.7%) is destined for the market and who can pay for a system

Table 5 Chi-Square Tests result for: Farm characteristics affecting WTP

Variables	WTP for early warning climate system		p-value
	yes	No	
<b>crop yield Income</b>			0.024
<50 %	28.74	47.12	
50 - 90%	5.71	5.71	
>90%	8.61	4.11	
<b>Wheat Planted Area (Dyn)</b>			<0.001
<10	2.9	4.7	
10-50	22.8	48.5	
>50	16.4	4.7	
<b>Maize Planted Area (Dyn)</b>			0.073
<10	3.1	3.1	
10-50	24.7	43.8	
>50	14.2	11.1	
<b>Maize Cost (Dyn)</b>			0.028
<15000	8.8	5	
15000-25000	33.4	52.8	
<b>Wheat Cost (Dyn)</b>			<0.001
<15000	29.8	15.2	
15000-25000	11.1	42.7	
>25000	1.2	0	

<b>Wheat market orientation</b>			0.006
<50%	18.9	18.9	
50%-90%	10.4	21.7	
>90%	21.7	8.4	
<b>Maize market orientation</b>			0.628
<50%	22.6	11.3	
50%-90%	9.7	1.6	
>90%	38.7	16.1	

Source: Own elaboration

We are using ANOVA test to see if there are significant differences in amount of WTP for early warning climate system and agricultural income level. Farmers are divided into three groups (crop yield <50%, crop yield between 50% and 90%, crop yield >=90%). The ANOVA test result suggest that the amount of WTP for early warning climate system does not differ significantly between agricultural income groups ( $F_{2,72}=1.303$ ,  $p=.278$ ), because the significance of 0.278 is greater than the defined significance level of 5%.

Table 6. ANOVA test Result for Crop yield Groups

Crop yield Groups	Tests of Homogeneity of Variances				ANOVA	
	Means	Std. Deviation	Levene Statistic	Sig.	F	Sig.
<50 %	23,200	8792.390	5.862	0.004	1.303	0.278
50 - 90%	27,000	4216.370				
>90%	22,000	5916.080				

Source: Own elaboration

For Wheat Planted Area the ANOVA test result suggest that the amount of WTP for early warning climate system does not differ significantly between Wheat Planted Area groups ( $F_{2,69}=0.213$ ,  $p=.809$ ), because the significance of 0.809 is greater than the defined significance level of 5%.

Table 7. ANOVA test Result for *Wheat Planted Area (Dyn)* Groups

Wheat Planted Area (Dyn)	Tests of Homogeneity of Variances				ANOVA	
	Means	Std. Deviation	Levene Statistic	Sig.	F	Sig.
<10	22,000	11510.864	3.959	0.024	0.213	0.809
10-50	23,718	8789.793				
>50	24,464	6431.877				

Source: Own elaboration

#### 4.4 Farmers' WTP for early warning climate system

The analysis showed that 43.2% of the farmers are ready to contribute financially to benefit from the early warning climate system in order to reduce climate risks on agricultural productivity (Table 8). However, 56.8% of the farmers need climate information but are not willing to pay for it. The mean of WTP is estimated as LEK 23,618.42/year per farmer. The median WTP shows that are willing to pay LEK 25,000/year to benefit from the climate information. The average and median WTP revealed the interest of farmers in using climate information (Kenkel & Norris, 1995). Hanemann (1984) recommended using median WTP to measure the economic level because average WTP can be very sensitive for small changes in the distribution of WTP, while the median is much more robust to these effects.

Table 8. WTP for early warning climate system.

	<i>WTP for early warning climate system</i>
Yes(%)	43.2
No(%)	56.8
Average WTP	23618.42
Median WTP	25000

Source: Own elaboration

#### 4.5 Factors Affecting Farmers Households' Option Value for early warning climate system

The Multiple binary logistic regression was used to analyze the determinants of farmers' WTP. The results reveal a difference between the determinants of demand for early warning climate system and WTP (Table 9). The variables significantly affecting farmers' demand for early warning climate system are farmers' age, awareness on climate conditions and the income from production.

A non-significant result ( $p > 0.05$ ) of the Hosmer and Lemeshow (2000) model suggests that the model estimated with the independent variables is better than the null model. The estimated model has a chi-square ( $\chi^2(8)$ ) of 6.731 and a p-value of 0.57, suggesting an adequate fit.

Table 10 Hosmer and Lemeshow Test

Chi-square	df	Sig.
6.731	8.000	0.57

Another commonly used adjustment measure is the Omnibus test of model coefficients. It is a chi-square test comparing the model's variance with the independent variables and the null model (just the intercept). Unlike the Hosmer and Lemeshow test, a significant result ( $p < 0.05$ ) suggests an adequate fit. According to the data, the model has a chi-square of 39.2796 ( $p$ -value  $< 0.001$ ), that is, the fitted model is better than the null model.

Table 11 Omnibus Tests of Model Coefficients

Chi-square	df	Sig.
39.279	6.000	0.00

Table 12 Model Summary

-2 Log likelihood	Cox & Snell R Square	Nagelkerke R Square
183.269a	0.213	0.29

a. Estimation terminated at iteration number 4 because parameter estimates changed by less than .001.

Age has a negative significant ( $p=00.5<5%$ ) effect on farmers' WTP decision. Young farmers may be more aware of climate conditions and may be willing to have up-to-date information on weather conditions. Considering the high innovativeness of young farmers, they may be willing to pay for climate forecasts in order to improve their decision-making in technology adoption. According to Zongo et al. (2016) younger farmers are willing to pay higher amounts for rainfall-based insurance because they have less experience in predicting weather conditions and are also exposed to new technologies.

Farm size (Hectares) has a positive significant effect on Farmers' WTP at a threshold of 10%. According to Dinh et al.2020 age (higher), sex (men), farm size (larger) and on-farm income (higher)



significantly and positively affected the amount farmers were willing to pay for weather forecast information.

The analysis shows, that the income from grain production negatively affects the WTP for early warning climate system at a threshold of 10%. One of the reasons may be farmers are reluctant to contribute their grain income into expenditure related to climate information. Grain production is intended for food consumption of farmers. Farmers rarely sell grain production as they usually cover their food needs (Janin et al. 2010).

The awareness of farmers in climate changes significantly influences the demand for climate information at 10% threshold. Zongo et al. 2016 showed awareness of climate information had a higher positive effect on farmers' WTP for Climate Information System. Evidence from research suggests a strong relationship between farmers' awareness and perceptions of climate change and their adaptation to its impacts (Adger et al. 2009; Debela et al. 2015). There is strong evidence that the more the farmers are aware, the more likely they are to have positive perceptions about the impacts of climate change (Ado et al. 2019)

Table 9. Results of the Multiple Binary Logistic regression Model

Variables	B	S.E.	Wald	df	Sig.	Exp(B)	95% C.I.for EXP(B)	
							Lower	Upper
Age	-0.065**	0.023	8.01	1	0.005	0.937	0.896	0.98
Income from main activity	0.008	0.007	1.34	1	0.247	1.008	0.995	1.02
Wheat planted Area	0.019***	0.011	3.14	1	0.076	1.019	0.998	1.04
Farmer's experience	0.043	0.032	1.82	1	0.178	1.044	0.981	1.11
Awareness	0.911***	0.517	3.10	1	0.078	2.487	0.903	6.85
Wheat (kv)	-0.003***	0.002	2.97	1	0.085	0.997	0.994	1.00
Constant	1.578	0.890	3.14	1	0.076	4.843		

Note. \*\*\*, \*\* and \* respectively denote significant levels of 1%, 5%, and 10%. Source: Author's survey (2023).

Based on this result, it is obvious that all variables play an important role on this model. Referring to the result table, the probability of this model can be calculated as follows:

$$Li = 1.578 - 0.065 * \text{Age} + 0.019 * \text{Wheat planted Area} + 0.911 * \text{Awareness} - 0.003 * \text{Wheat (kv)}$$

$$P(Y = 1) = \frac{1}{1 + e(-Li)}$$

## 5. Conclusions and Recommendations

This study analyzed the perception and WTP for early warning climate system in region of Korca/Fier. It showed that a large majority (31.8% able to pay and 51.7% not able to pay) of farmers expresses awareness about climate changes in last 10 years. Farmers have perceived high changes in the occurrence of natural events, such as the increase in the period of drought (58.3%), the decrease in the number of days with precipitation (56.9%) and the increase in days with high temperatures (54.9%). Despite the farmers' high awareness and perceptions towards climatic conditions, again the 43.2% of them who are willingness to pay for early warning climate system was low.

The determining factors of the demand for early warning climate system are the farmers' age, farm size, production, awareness to climate changes. About 43.2% of the farmers willing to pay would pay an average of Lek 23618.42 to obtain climate information from an early warning climate system.

As a conclusion, we can emphasize that the use of climate information can help farmers in making

decisions, but it is not clear how this type of information affects farm income and adaptation strategies to these climatic changes.

### References

- Zhang, Q.; Shi, R.; Singh, V.P.; Wang, J.A.; Liang, Q.O.(2022) Droughts across China: Drought factors, prediction and impacts. *Sci. Total Environ.* , 803, 150018. [Google Scholar] [CrossRef]
- Keshavarz, M.; Maleksaeidi, H.; Karami, E. 2017 Livelihood vulnerability to drought: A case of rural Iran. *Int. J. Disast. Risk. Reduct.* , 21, 223–230. [Google Scholar] [CrossRef]
- Nasrnia, F.; Ashktorab, N. 2021 Sustainable livelihood framework-based assessment of drought resilience patterns of farmers of Bakhtegan basin, Iran. *Ecol. Indic.*, 128, 107817. [Google Scholar] [CrossRef]
- Ahmad, M.M.; Yaseen, M.; Saqib, S.E.2022 Climate change impacts of drought on the livelihood of dryland smallholders: Implications of adaptation challenges. *Int. J. Disast. Risk. Reduct.* , 80, 103210. [Google Scholar] [CrossRef]
- Mayorga, Joaquin & Villacis, Alexis & Mishra, Ashok. (2023). Feeling the Heat: High Temperatures and Farm-level Agricultural Productivity.
- Gebremariam, G.G.; Edriss, K.A.; Maganga, M.A.; Terefe, T.A. 2013 Labor as a Payment Vehicle for Valuing Soil Conservation Practices in a Subsistence Economy: Case of Adwa Woreda in Ethiopia. *Am. J. Econ.* 2013, 3, 283–290. [Google Scholar] [CrossRef]
- Hosmer Jr, D. W., Lemeshow, S., & Sturdivant, R. X. (2013). *Applied logistic regression* (Vol. 398). John Wiley & Sons.
- Fosdal, S. (2017). *The use of logistic regression and quantile regression in medical statistics* (Master's thesis, NTNU).
- Zongo, B., Diarra, A., Barbier, B., Zorom, M., Yacouba, H., & Dogot, T. (2016). Farmers' perception and willingness to pay for climate information in Burkina Faso. *Journal of Agricultural Science*, 8(1), 175–187. <https://doi.org/10.5539/jas.v8n1p175>.
- Duc Truong Dinh 2020, Economic Valuation of Agricultural producers' WTP for the weather information service – A Case Study in Central Vietnam
- Janin, P. (2010). Sécurité alimentaire et changement climatique: une lecture géopolitique des crises africaines et de leurs conséquences. *Géopolitiques*, 4, 1-11.
- Adger, W. N., Dessai, S., Goulden, M., Hulme, M., Lorenzoni, I., Nelson, D. R. (2009). Are there social limits to adaptation to climate change? *Climatic Change*, 93, 335–354
- Abdou Matsalabi Ado, Jin Leshan, Patrice Savadogo, Li Bo, Ashfaq Ahmad Shah, 2019 Farmers' Awareness and Perception of Climate Change impacts: Case study of Aguié district in Niger
- Teqja, Z., Kopali, A., Libohova, Z. and Owens, P. (2017). A study of the Impacts of climate change scenarios on the plant hardiness zones of Albania. *J. of Appl. Meteorology and Climatology*. 56(3): 615–631. DOI: <https://doi.org/10.1175/JAMC-D-16-0108.1>
- FAO (2018). Comprehensive analysis of disaster risk reduction and management system for agriculture in Albania. URL: <http://www.fao.org/3/i8866en/I8866EN.pdf>
- Stott, P.(2016) How climate change affects extreme weather events. *Science* 2016, 352, 1517–1518
- Oliveira, T. H., Painho, M., Santos, V., Sian, O., & Barriguinha, A. (2014). Development of an agricultural management information system based on Open-Source solutions.
- K. Eriksson-Backa, A. Luoma, and E. Krook , 2012. Impact of Online Agro-Technology Diploma Program and Its Future Perspectives for Improving Socio-economic Well-Being of Farmers in Sri Lanka
- Kursat Demiryurek 2000, The Analysis of Information Systems for Organic and Conventional Hazelnut Producers in Three Villages of the Black Sea Region, Turkey.
- Julio A. Berdegué and Germán Escobar 2001, AGRICULTURAL KNOWLEDGE AND INFORMATION SYSTEMS AND POVERTY REDUCTION
- Lu, Y., Pan, Z., Lu, Y., Qin, H., & Wang, B. (2015). Acceptance of government-sponsored agricultural information systems in China: The role of government social power. *Information Systems and e-Business Management*, 13(1), 329–354. doi:10.1007/10257-014-0235-6.
- Baumüller, H. (2018). The little we know: an exploratory literature review on the utility of mobile phone enabled services for smallholder farmers. *Journal of International Development*, 30(1), 134-154.

- Amer, J., Odero, D., Kwake, A. (2018). Towards Improving Agricultural Marketing Information Systems for Smallholder Farmers: A Tharaka Nithi Case. *Journal of Agriculture and Sustainability*, 11(2), 99-128.
- Juma, M. F., Fue, K. G., Barakabitze, A. A., Nicodemus, N., Magesa, M. M., Kilima, F. T. M., & Sanga, C. A. (2017). Understanding Crowdsourcing of Agricultural Market Information in a Pilot Study: Promises, Problems and Possibilities (3Ps). *International Journal of Technology Diffusion (IJTD)*, 8(4), 1-16.
- Kenkel, P. L., & Norris, P. E. (1997). Agricultural Producers' Willingness to Pay for Real-Time Mesoscale Weather Information: A Response. *Journal of Agricultural and Resource Economics*, 22(2), 382-386.
- Parker, D., Zilberman D., Cohen D., & Osgood D (1996). "The Economic Costs and Benefits Associated with the California Irrigation Management Information System (CIMIS): Final Report." Rep. California Department of Water Resources
- Schenk, E. Guittard, C. , 2011, Towards a characterization of crowdsourcing practices, *J. Innovation Econ. Manage.*, 7 (1) (2011), pp. 93-107
- Ajzen, I. (2011). The theory of planned behaviour: Reactions and reflections. *Psychology & health*, 26(9), 1113-1127.
- Minet, J., Curnel, Y., Gobin, A., Goffart, J. P., Mélard, F., Tychon, B., ... & Defourny, P. (2017). Crowdsourcing for agricultural applications: A review of uses and opportunities for a farmsourcing approach. *Computers and Electronics in Agriculture*, 142, 126-138.





## Veri Madenciliği ve Çok Ölçütlü Karar Verme Yöntemleri ile Bir Hibrit Sınıflandırma Yaklaşımı

**Gözde Ulu Metin<sup>1\*</sup>, Özlem Türkşen<sup>2</sup>**

<sup>1</sup>Ankara Üniversitesi, Fen Bilimleri Enstitüsü, İstatistik Anabilim Dalı, 06110, Ankara, Türkiye

<sup>2</sup>Ankara Üniversitesi, Fen Fakültesi, İstatistik Bölümü, 06100, Ankara, Türkiye

\*Sorumlu yazar e-mail: gozdeulumetin@gmail.com

### Özet

Veri-bilgi keşfi sürecinde ön işleme yapılmış veriden anlamlı bilgilerin elde edilmesi amacıyla veri madenciliği yöntemleri uygulanır. Elde edilen bilgiler, karar destek sistemlerinde önemli rol oynamaktadır. Bu çalışmada, veri madenciliği ve çok ölçütlü karar verme yöntemleri kullanılarak hibrit bir sınıflandırma yaklaşımı önerilmiştir. İşlenmiş veri setindeki değişkenlerin farklı önem derecelerine sahip olduğu düşünülerek değişkenler ENTROPY yöntemi ile objektif olarak ağırlıklandırılmıştır. Ağırlıklandırılmış veri setine veri madenciliği sınıflandırma yöntemlerinden Lojistik Regresyon (Logistic Regression-LR) analizi, k-En Yakın Komşu (k-Nearest Neighbour-kNN) algoritması, Destek Vektör Makineleri (Support Vector Machines-SVM) ve Rastgele Orman (Random Forest-RF) algoritması uygulanmıştır. Sınıflandırma yöntemlerinin performansı, 5-kat çapraz doğrulama ile elde edilen doğruluk, kesinlik, duyarlılık,  $F_1$ -Skor ve AUC performans ölçütleri kullanılarak hesaplanmıştır. Elde edilen değerlere göre sınıflandırma yöntemlerinin tercih sıralaması, çok ölçütlü karar verme yöntemleri (TOPSIS, EDAS ve GRA) ile belirlenmiştir. Çalışmada önerilen hibrit sınıflandırma yaklaşımının uygulanabilirliğinin gösterilmesi amacıyla Ar-Ge ve Tasarım merkezlerine ait gerçek bir veri seti kullanılmıştır. Uygulama sonucunda  $RF >> SVM >> LR >> kNN$  biçiminde veri madenciliği sınıflandırma yöntemlerinin tercih sıralamasına ulaşılmıştır.

**Anahtar kelimeler:** Veri Madenciliği Sınıflandırma Yöntemleri, Çok Ölçütlü Karar Verme, Ar-Ge ve Tasarım Merkezleri, Performans Ölçütleri

### GİRİŞ

Veri-bilgi keşfi sürecinde, ham veriden anlamlı bilgi elde edilmesi karar vermede önemli bir rol oynar. Geleneksel veri analizi yöntemlerinin yetersiz kaldığı ham veri setlerine veri madenciliği yöntemleri uygulanır. Veri madenciliği sınıflandırma yöntemleri uygulanmadan önce ham verinin işlenmiş olması gerekir. Veri ön işleme, veriden bilgi keşfi sürecinin en önemli aşamasıdır. Bu aşamada, veri temizleme, veri bütünleştirme, veri dönüştürme ve boyut azaltma çalışmaları gerçekleştirilir (Fayyad vd., 1996). Veri ön işleme sürecinde keşfedici veri analizi, betimsel istatistiklerden yararlanılarak yapılır. Veri setinde değişken türleri tespit edilerek bağımlı ve bağımsız değişkenler belirlenir. Çizelge 1’de çok değişkenli veri seti örneği görülmektedir.  $X_1, X_2, \dots, X_n$  bağımsız değişkenler ve  $Y$  bağımlı değişken olmak üzere Çizelge 1’de görüldüğü gibi veri kümesi  $n$  gözlemden oluşmaktadır.

**Çizelge 1.** Çok değişkenli veri seti

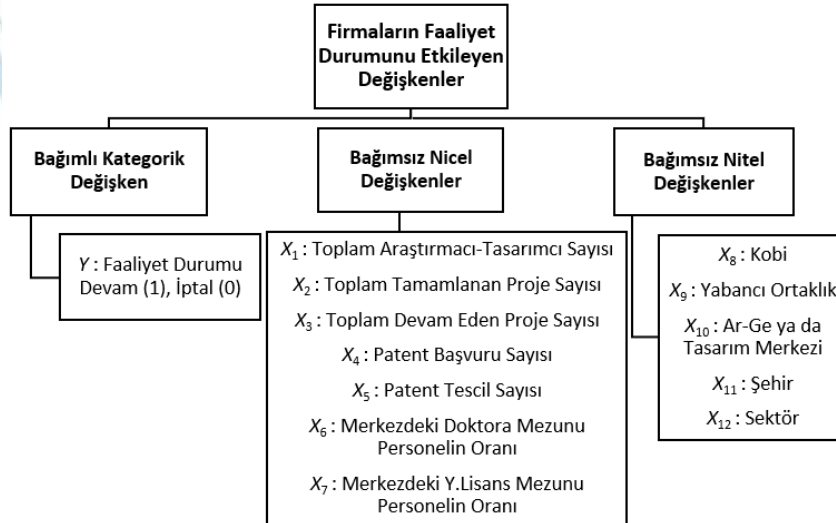
No.	Bağımsız değişkenler				Bağımlı değişken
	$X_1$	$X_2$	...	$X_m$	$Y$
1	$x_{11}$	$x_{12}$	...	$x_{1m}$	$y_1$
2	$x_{21}$	$x_{22}$	...	$x_{2m}$	$y_2$
⋮	⋮	⋮	⋮	⋮	⋮
$n$	$x_{n1}$	$x_{n2}$	...	$x_{nm}$	$y_n$

Veri setindeki bağımsız değişkenler farklı önem ağırlıklarına sahip olabilir. Değişkenlerin sahip olduğu farklı ağırlıklar dikkate alınarak veriden daha anlamlı bilgi elde edilmesi sağlanır. Veri setindeki değişken ağırlıklarının belirlenmesinde Çok Ölçütlü Karar Verme (Multi Criteria Decision Making-MCDM) yöntemleri kullanılır. Değişken ağırlıkları veriye dayalı bir biçimde objektif olarak MCDM yöntemleri ile hesaplanır. Veri setinin ön işleme süreci tamamlanarak veri madenciliği sınıflandırma yöntemlerine hazır hale getirilir. Sınıflandırma yöntemlerinin değerlendirilmesinde performans ölçütleri kullanılır. Hesaplanan performans değerlerine göre sınıflandırma yöntemlerinin tercih sıralaması MCDM yöntemleri ile belirlenir. Bu çalışmada, veri madenciliği sınıflandırma yöntemleri ile MCDM yöntemleri hibrit edilerek özgün bir sınıflandırma yaklaşımı önerilmiştir. Önerilen hibrit sınıflandırma yaklaşımının gerçek bir veri seti üzerinde uygulanabilirliği gösterilmiştir.

## MATERYAL VE METOT

### Veri Seti

Sanayi ve Teknoloji Bakanlığı bünyesindeki Ar-Ge Teşvikleri Genel Müdürlüğü'ne bağlı Ar-Ge ve Tasarım Merkezleri Dairesi Başkanlığı tarafından Ar-Ge veya Tasarım merkezi olup yenilikçi çalışmalar yürüterek ülkemize katma değer yaratan firmalara çeşitli destek ve teşvik sağlanmaktadır (Anonim, 2016). Bu teşviklerden yararlanmak isteyen firmalar gerekli şartları yerine getirerek faaliyetlerine devam etmektedir. Bu çalışmada önerilen hibrit sınıflandırma yaklaşımı kullanılarak firmaların faaliyetlerine göre sınıflandırılması istenmiştir. Bu amaçla, Ar-Ge ve Tasarım Merkezleri Dairesi Başkanlığı'ndan Ar-Ge veya Tasarım merkezi olan firmalara ait ham veri seti temin edilmiştir. Veri seti, 2008-2021 yılları arasında faaliyeti devam eden 2334 adet Ar-Ge ve Tasarım merkezlerini kapsamaktadır. Şekil 1'de verilen veri setindeki bağımsız değişkenler, Ar-Ge ve Tasarım merkezi belgesine sahip firmaların faaliyetlerini etkileyen değişkenlerdir. Veri setindeki bağımlı değişken ise firmaların Ar-Ge ve Tasarım merkezlerindeki faaliyetlerine devam edip etmemeye durumunu anlatan kategorik bir değişkendir. Çalışmada yapılan analizler için Python 3.11.3 programı ve kütüphaneleri kullanılmıştır.



Şekil 1. Firmaların faaliyet durumunu etkileyen değişkenler

Şekil 1'deki veri seti, bir (1) bağımlı kategorik değişken, yedi (7) bağımsız nicel ve beş (5) bağımsız nitel değişkenden oluşur. Ham veride veri temizliği yapıldıktan sonra farklı önem ağırlıklarına sahip olan değişkenlerin veriye dayalı olarak değişken ağırlığı objektif bir biçimde MCDM yöntemleri ile

hesaplanır. Bu çalışmada ENTROPY yöntemi uygulanmıştır. ENTROPY yöntemi nicel değişkenlerin bilgisine dayalı olarak değişken ağırlığı belirlemede kullanılır.

### ENTROPY

ENTROPY yöntemi, değişken ağırlıklarının belirlenmesinde kullanılan bir MCDM yöntemidir (Shannon, 1948). ENTROPY uygulama adımları aşağıda verilmiştir.

**Adım1:**  $X$  karar matrisi, Çizelge 1'de verilen  $n$  gözlemlili  $m$  sayıda bağımsız değişkenden oluşan bir veri setinde  $n \times m$  boyutlu

$$X = [x_{ij}]_{n \times m} = \begin{bmatrix} x_{11} & x_{12} & \cdots & x_{1m} \\ x_{21} & x_{22} & \cdots & x_{2m} \\ \vdots & \vdots & \ddots & \vdots \\ x_{n1} & x_{n2} & \cdots & x_{nm} \end{bmatrix} \quad (1)$$

olarak tanımlanır.

**Adım2:** Karar matrisi

$$x_{ij}^* = \frac{x_{ij}}{\sum_{j=1}^m x_{ij}}, \quad i = 1, 2, \dots, n \quad (2)$$

biçiminde normalleştirilir. Normalleştirilmiş karar matrisi  $N = [x_{ij}^*]_{n \times m}$  oluşturulur.

**Adım3:** Her bir değişken için ENTROPY değeri

$$E_j = -\frac{1}{\ln(n)} \sum_{i=1}^n x_{ij}^* \ln(x_{ij}^*) \quad j = 1, 2, \dots, m \quad (3)$$

hesaplanır.

**Adım4:** Her bir değişken için belirsizlik değeri

$$d_j = 1 - E_j, \quad j = 1, 2, \dots, m \quad (4)$$

elde edilir.

**Adım5:** Değişken ağırlıkları

$$w_j = \frac{d_j}{\sum_{j=1}^m d_j}, \quad j = 1, 2, \dots, m \quad (5)$$

biçimindedir. ENTROPY yöntemi ile Eşitlik (5) kullanılarak hesaplanan değişken ağırlıkları Çizelge 2'de verilmiştir.

**Çizelge 2.** ENTROPY yöntemi ile değişken ağırlıkları

Değişkenler	w
Araştırmacı-Tasarımcı sayısı ( $X_1$ )	0.0841
Toplam tamamlanan proje sayısı ( $X_2$ )	0.0761
Toplam devam eden proje sayısı ( $X_3$ )	0.0446
Patent başvuru sayısı ( $X_4$ )	<b>0.2853</b>
Patent tescil sayısı ( $X_5$ )	0.2807
Merkezdeki doktora mezunu personelin oranı ( $X_6$ )	0.1866
Merkezdeki y. lisans mezunu personelin oranı ( $X_7$ )	0.0423



Çizelge 2'ye göre Ar-Ge ve Tasarım merkezlerinin faaliyetlerinde en yüksek önem ağırlığına patent başvuru sayısı sahipken, en düşük önem değişken ağırlığına merkezdeki y. lisans mezunu personelin oranı sahiptir. ENTROPY yöntemi ile elde edilen değişken ağırlıkları  $\mathbf{w} = [w_1 \ w_2 \ \dots \ w_7]$   $X$  karar matrisi ağırlıklandırılır. Hesaplanan değişken ağırlıkları ile veri setindeki değişkenler  $\zeta_i = w_i X_i$ ,  $i=1,2,\dots,7$  biçiminde ağırlıklandırılır. Veri ön işleme süreci tamamlanarak ağırlıklandırılmış veri setine, veri madenciliği sınıflandırma yöntemi uygulanır.

### Veri Madenciliği Sınıflandırma Yöntemleri

#### Lojistik Regresyon

Lojistik regresyon (LR), veri setindeki gözlemlerin belirli bir sınıfa ait olma olasılığını hesaplayarak yeni gözlemleri sınıflandıran bir veri madenciliği yöntemidir.  $Y_i \in \{0,1\}$  iki sınıflı bir bağımlı değişkene sahip  $\{(X_i, Y_i)\}_{i=1}^n$  biçimde gözlem çifti ile tanımlanmış bir veri seti olsun. Bu veri setinde, bağımlı değişken kategorik olduğundan bağımlı değişkenin olasılığı hesaplanıp logit dönüşüm uygulanarak

$$f_{LR}(\zeta_i) = \frac{1}{1 + e^{-(\beta_0 + \beta_1 \zeta_{i1} + \beta_2 \zeta_{i2} + \dots + \beta_m \zeta_{im})}}, \quad i = 1, 2, \dots, n \quad (6)$$

lojistik regresyon modeli oluşturulur. Eşitlik (6) bir olasılık değeri olup eşik değeri 0.5 alındığında

$$\begin{aligned} f(\zeta_i) \geq 0.5, & \Rightarrow \hat{Y}_i = 1 \\ f(\zeta_i) < 0.5, & \Rightarrow \hat{Y}_i = 0 \end{aligned} \quad (7)$$

biçiminde sınıflandırılır. Optimizasyon modeli

$$\begin{aligned} \max_{\beta_0, \beta_1, \dots, \beta_m \in \mathbb{R}} \quad & \ln L(\beta_0, \beta_1, \dots, \beta_m) \\ g(\boldsymbol{\beta}) = c \sum_{j=1}^m |\beta_j|^t \geq 0, \quad & t = 1, 2, \quad c \geq 0 \end{aligned} \quad (8)$$

ile tahmin olasılıkları maksimize edilir. Lojistik regresyonun ayarlanabilir parametreleri, kısıtlama yapılacak yöntemi (Lasso, Ridge, None) belirleyen ceza değeri (penalty) ve kısıtlama oranı (c)'dir (Burkov, 2021; Erden, 2021).

#### k-En Yakın Komşu Algoritması

k-En Yakın Komşu (k-Nearest Neighbour-kNN) algoritmasında, sınıfı belli olan gözlemlerin her biri ile yeni gelecek gözlem arasındaki uzaklıklar hesaplanarak yeni gözlemin sınıflandırıldığı bir veri madenciliği yöntemidir. Hesaplanan en küçük uzaklığa sahip k sayıda gözlemin sınıfları içerisinde en çok tekrar eden sınıf, yeni gözlem değerinin sınıfıdır (Sorghun, 2021). kNN modeli

$$f_{kNN}(\zeta_i, \zeta_j) = \sqrt{\sum_{t=1}^m (\zeta_{it} - \zeta_{jt})^2}, \quad i, j = 1, 2, \dots, n, \quad i \neq j \quad (9)$$

biçiminde yazılır. Gözlemler arasındaki en küçük uzaklığın elde edilmesi amaçlanır. Optimizasyon modeli

$$\min_{t \in \mathbb{R}} f_{kNN}(\zeta_i, \zeta_j) \quad (10)$$

biçimindedir. Doğrusal olmayan optimizasyon problem çözümü için türeve dayalı optimizasyon yöntemleri kullanılır (Türkşen, 2023). k parametresinin belirlenmesi önemlidir.

### Destek Vektör Makineleri

Destek Vektör Makineleri (Support Vector Machines-SVM) veriyi sınıflamak için uygun bir fonksiyonu kullanan veri madenciliği yöntemlerinden biridir.  $Y_i \in \{-1,1\}$  iki sınıflı bağımlı değişkene sahip  $\{(X_i, Y_i)\}_{i=1}^n$  biçimde gözlem çifti ile tanımlanmış bir veri seti olsun.  $Y_i = -1$  ve  $Y_i = 1$  olarak belirlenen iki sınıf  $H$  hiperdüzlemi

$$H \text{ düzlemi: } \langle \boldsymbol{\beta}, \mathbf{x} \rangle + \beta_0 = 0 \quad (11)$$

ile ayrılır.  $H$  düzlemine kenar payı uzaklıkları  $d$  olan  $H_1$  düzlemi ve  $H_2$  düzleminin denklemleri Eşitlik (11) kullanılarak

$$\begin{aligned} H_1 \text{ düzlemi: } \langle \boldsymbol{\beta}, \mathbf{x} \rangle + \beta_0 - d &= 0 \\ H_2 \text{ düzlemi: } \langle \boldsymbol{\beta}, \mathbf{x} \rangle + \beta_0 + d &= 0 \end{aligned} \quad (12)$$

biçiminde yazılır. Kenar payı uzunluğunun en büyük olacak biçimde, gözlemlerin sınıflandırılması amaçlanır. Sınıflandırma işlemi yapılırken karşı sınıfta en az sayıda farklı sınıftan gözlemin olması ve  $H_1$  düzlemi ile  $H_2$  düzlemi üzerinde en az birer destek vektörünün bulunması istenir (Cortes and Vapnik, 1995). SVM sınıflandırması

$$\begin{aligned} \min_{\boldsymbol{\beta} \in \mathbb{R}} f(\boldsymbol{\beta}) &= \frac{1}{2} \langle \boldsymbol{\beta}, \boldsymbol{\beta} \rangle \\ g(\boldsymbol{\beta}, \beta_0) &= y_i (\langle \boldsymbol{\beta}, \mathbf{x}_i \rangle + \beta_0) - 1 \geq 0, \quad i=1,2,\dots,n \end{aligned} \quad (13)$$

uygun bir biçimde birleştirilip optimizasyon problemi gibi yazılır. SVM ile yeni gelen gözlemler

$$f(\boldsymbol{\zeta}) = \text{sign}(\boldsymbol{\beta}^T \boldsymbol{\zeta} + \beta_0) = \text{sign}\left(\sum_{i=1}^n \lambda_i y_i \langle \boldsymbol{\zeta}, \boldsymbol{\zeta}_i \rangle + \beta_0\right) \quad (14)$$

biçiminde sınıflandırılır. Doğrusal sınıflamanın mümkün olmadığı ya da değişken sayısının fazla olduğu durumlarda, SVM yöntemi çekirdek fonksiyonları kullanarak sınıflandırma yapar (Uğuz, 2021). Çekirdek fonksiyonu

$$K(\mathbf{x}_i, \mathbf{x}_j) = \langle \phi_{x_i}, \phi_{x_j} \rangle = \left( \langle \mathbf{x}_i, \mathbf{x}_j \rangle \right)^2 \quad (15)$$

kullanılır. Yaygın olarak kullanılan çekirdek fonksiyonları doğrusal, polinom, dairesel tabanlı ve sigmoid fonksiyonlarıdır. SVM için ayarlanabilir parametreler, kısıtlama oranı ( $c$ ), çekirdek fonksiyonları ve ( $c$ ) oranını düzenleyici değer olan gamma'dır.

### Rastgele Orman Algoritması

Rastgele Orman Algoritması (Random Forest-RF), verilen veri kümesinin çeşitli alt kümelerinde birden çok sayıda karar ağacı içeren sınıflandırma yöntemidir. RF, tek bir karar ağacına güvenmek yerine her ağaçtan tahminleri toplayarak çoğunluk oylaması ile tahmin eder. Ağaç sayının artmasıyla modelin performansı artar. RF tüm değişkenleri kullanmak yerine her bir düğümde Gini ya da Entropy indeksi kullanarak değişken seçimi yapar.  $B$  oluşturulan ağaç sayısı olmak üzere ( $b=1,2,\dots,B$ ),  $b$ . ağacın sınıf tahmini

$$\hat{C}_{RF}^B(\boldsymbol{\zeta}) = \text{çoğunluk oylaması} \left\{ \hat{C}_b(\boldsymbol{\zeta}_i) \right\}_1^B, \quad i=1,2,\dots,n \quad (16)$$

biçiminde hesaplanır. Ağaç performansının değerlendirilmesinde hata oranının minimum yapılması istenir (Arlı vd. 2022). Optimizasyon problemi

$$\min_{\zeta \in \mathbb{R}} E_{OOB} = \frac{1}{n} \sum_{b=1}^B I(y_i - \hat{C}_{RF}^B(\zeta)) \quad (17)$$

çözülür. RF için ayarlanabilir parametreler; maksimum derinlik, maksimum değişken, minimum yaprak örneği, minimum örneklem, oluşan ağaç sayısı ( $b$ ) ve indeks hesaplama yöntemi (Gini, Entropy)'dir.

Veri madenciliği sınıflandırma yöntemlerinin performansları bakımından karşılaştırılabilmesi için sınıflandırma performans ölçütlerinin hesaplanması gerekir.

### Sınıflandırma Performans Ölçütleri

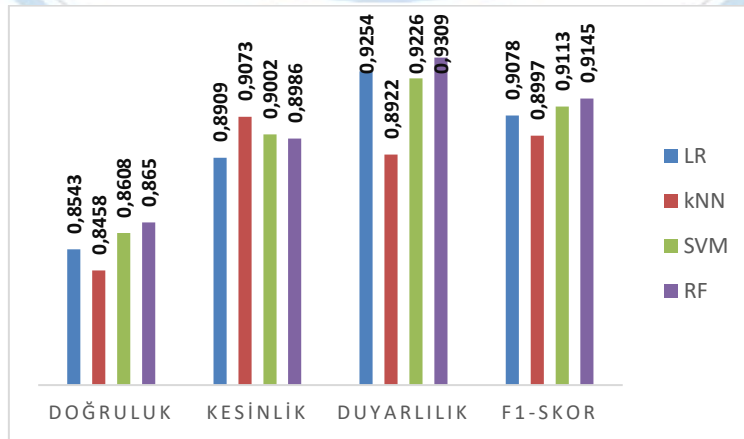
Sınıflandırma yöntemleri ile elde edilen modellerin tahmin performanslarının değerlendirilebilmesi için performans ölçütleri kullanılır. Her bir sınıflandırma yöntemine ait model performansının artmasını sağlayan ayarlanabilir parametreler bulunur (Geron, 2021). Performans ölçütlerinin hesaplanmasında Çizelge 3'te verilen karışıklık matrisi kullanılır.

Çizelge 3. Karışıklık matrisi

		Tahmin Sınıfı	
		Pozitif	Negatif
Gerçek Sınıf	Pozitif	Doğru Pozitif (DP)	Yanlış Negatif (YN)
	Negatif	Yanlış Pozitif (YP)	Doğru Negatif (DN)

Çizelge 3'te verilen karışıklık matrisi kullanılarak Doğruluk, Duyarlılık, Kesinlik,  $F_1$ -Skor ve AUC ölçütü hesaplanır. *Doğruluk*, doğru olarak sınıflandırılmış örneklerin toplam örnek sayısına oranı verir. *Duyarlılık*, doğru olarak sınıflandırılmış pozitif örnek sayısının toplam pozitif örnek sayısına oranını hesaplar. *Kesinlik*, pozitif olarak tahmin edilen değerlerin ne oranda doğru olarak tahmin edildiğini hesaplar.  *$F_1$ -Skor*, kesinlik ve duyarlılık ölçütünün harmonik ortalaması olan bir ölçüttür. *AUC* ölçütü, ROC eğrisinin altında kalan alan toplamıdır (Kumar, 2020).

Sınıflandırma yöntemlerine ilişkin performans ölçütleri Şekil 2'de verilmiştir.



Şekil 2. Veri setine ilişkin performans değerleri



Şekil 2’de verilen performans değerlerine göre sınıflandırma yöntemlerini karşılaştırmak zordur. Sınıflandırma yöntemlerini objektif olarak karşılaştırmak için MCDM yöntemleri kullanılmıştır.

#### Çok Ölçütlü Karar verme Yöntemleri

MCDM birden çok kritere sahip alternatifler arasından en uygun alternatifin belirlenmesidir. MCDM’nin ilk aşamasında öncelikle bir karar matrisi oluşturulur. Karar matrisi satırlarda alternatifler (sınıflandırma yöntemleri) ve sütunda kriterler (performans ölçütleri) olacak

$$D = [d_{ij}]_{n \times m} = \begin{bmatrix} d_{11} & d_{12} & \cdots & d_{1m} \\ d_{21} & d_{22} & \cdots & d_{2m} \\ \vdots & \vdots & \ddots & \vdots \\ d_{n1} & d_{n2} & \cdots & d_{nm} \end{bmatrix} \quad (18)$$

biçimde oluşturulur. Bu çalışmada MCDM yöntemlerinden normalleştirme yaklaşımı toplama dayalı TOPSIS, orana dayalı EDAS ve min-max değerine dayalı GRA kullanılmıştır. Her bir kriter eşit öneme sahip olup performans ölçütleri maksimum olacak biçimde fayda amacına uygun Çizelge 4’teki formüller uygulanmıştır. Eşitlik (18)’deki karar matrisi her bir MCDM yöntemi için uygun formül kullanılarak normalize edilir (Vafaei, 2022). Uygulanan MCDM yöntemlerine ilişkin uygulama adımları aşağıda verilmiştir.

**Çizelge 4.** Normalleştirme yaklaşımları ve uygulama amaçlarına göre formüller

<i>Yaklaşımlar</i>	<i>Uygulama Amacı</i>	<i>Formüller</i>
<i>Toplam</i>	<i>Fayda</i>	$v_{ij} = \frac{d_{ij}}{\sqrt{\sum_{k=1}^n d_{kj}}}$
<i>Oran</i>	<i>Fayda</i>	$v_{ij} = \frac{d_{ij}}{\max d_{ij}}$
<i>Min-max</i>	<i>Fayda</i>	$v_{ij} = \frac{d_{ij} - \min_j(d_{ij})}{\max_j(d_{ij}) - \min_j(d_{ij})}$

**Adım1:**  $D$  karar matrisi Eşitlik (18)'deki biçimde oluşturulmuştur.

**Çizelge 5.** TOPSIS uygulama adımları

Adım 2	Adım 3	Adım 4	Adım 5
$V = [v_{ij}]_{n \times m} = \begin{bmatrix} v_{11} & v_{12} & \cdots & v_{1m} \\ v_{21} & v_{22} & \cdots & v_{2m} \\ \vdots & \vdots & \ddots & \vdots \\ v_{n1} & v_{n2} & \cdots & v_{nm} \end{bmatrix}$	$V^+ = [v_j^+]_{1 \times m} = [v_1^+ \quad v_2^+ \quad \cdots \quad v_m^+]$ $V^- = [v_j^-]_{1 \times m} = [v_1^- \quad v_2^- \quad \cdots \quad v_m^-]$	$S_i^+ = \sqrt{\sum_{j=1}^m (v_{ij} - v_j^+)^2}, \quad i = 1, 2, \dots, n$ $S_i^- = \sqrt{\sum_{j=1}^m (v_{ij} - v_j^-)^2}, \quad i = 1, 2, \dots, n$	$C_i = \frac{S_i^-}{S_i^+ + S_i^-}, \quad i = 1, 2, \dots, n$

**Çizelge 6.** EDAS uygulama adımları

Adım 2	Adım 3	Adım 4	Adım 5	Adım 6
$AV_j = \frac{1}{n} \sum_{i=1}^n d_{ij}, \quad j = 1, 2, \dots, m$	$PDA_{ij} = \frac{\max(0, (d_{ij} - AV_j))}{AV_j}$ $NDA_{ij} = \frac{\max(0, (AV_j - d_{ij}))}{AV_j}$ $i = 1, 2, \dots, n, \quad j = 1, 2, \dots, m$	$SP_i = \sum_{j=1}^m PDA_{ij}$ $SN_i = \sum_{j=1}^m NDA_{ij}$ $i = 1, 2, \dots, n, \quad j = 1, 2, \dots, m$	$NSP_i = \frac{SP_i}{\max_i(SP_i)}$ $NSN_i = 1 - \frac{SN_i}{\max_i(SN_i)}$ $i = 1, 2, \dots, n$	$AS_i = \frac{NSP_i + NSN_i}{2}$ $i = 1, 2, \dots, n$

**Çizelge 7.** GRA uygulama adımları

Adım 2	Adım 3	Adım 4	Adım 5	Adım 6
$d_0 = (d_0(j)), \quad j = 1, 2, \dots, m$	$V = [v_{ij}]_{n \times m} = \begin{bmatrix} v_{11} & v_{12} & \cdots & v_{1m} \\ v_{21} & v_{22} & \cdots & v_{2m} \\ \vdots & \vdots & \ddots & \vdots \\ v_{n1} & v_{n2} & \cdots & v_{nm} \end{bmatrix}$	$\Delta = [\Delta_{ij}]_{n \times m} = \begin{bmatrix} \Delta_{11} & \Delta_{12} & \cdots & \Delta_{1m} \\ \Delta_{21} & \Delta_{22} & \cdots & \Delta_{2m} \\ \vdots & \vdots & \ddots & \vdots \\ \Delta_{n1} & \Delta_{n2} & \cdots & \Delta_{nm} \end{bmatrix}$	$\gamma = [\gamma_{ij}]_{n \times m} = \begin{bmatrix} \gamma_{11} & \gamma_{12} & \cdots & \gamma_{1m} \\ \gamma_{21} & \gamma_{22} & \cdots & \gamma_{2m} \\ \vdots & \vdots & \ddots & \vdots \\ \gamma_{n1} & \gamma_{n2} & \cdots & \gamma_{nm} \end{bmatrix}$	$\Gamma_i = \frac{1}{m} \sum_{j=1}^m \gamma_{ij}, \quad i = 1, 2, \dots, n$

Çizelge 5-7’de verilen adımlar uygulanmıştır (Hwang and Yoon, 1981; Deng, 1982; Zavadskas,1996; Ghorabae,2015; Ghorabae,2016; Pamučar,2015; Xie,2023; Kabak ve Çınar, 2020; Özçalıcı, 2017). Karşılaştırma sonuçları Çizelge 8’de verilmiştir.

### Hibrit Sınıflandırma Sonuçları

**Çizelge 8.** MCDM ile sınıflandırması yöntemlerinin karşılaştırılması

Yöntemler	$C_{TOPSIS}$	$AS_{EDAS}$	$\Gamma_{GRA}$
LR	0.6952	0.6078	0.5810
kNN	0.2076	0.0978	0.4666
SVM	0.8093	0.7736	0.6957
RF	<b>0.8783</b>	<b>0.9954</b>	<b>0.8968</b>

\*Her bir MCDM için öncelikli tercih edilen sınıflandırma yöntemi koyu renk ile belirtilmiştir.

Çizelge 8’de RF’nin tüm MCDM yöntemleri için en yüksek sıralama değerine sahip olduğu görülmektedir. Buna göre, Çizelge 9’da sınıflandırma yöntemleri sıralanmıştır.

**Çizelge 9.** MCDM ile sınıflandırması yöntemlerinin sıralanması

	Yöntemler	ENTROPY
Toplam	TOPSIS	RF>>SVM>>LR >>kNN
Oran	EDAS	RF>>SVM>>LR >>kNN
Min-max	GRA	RF>>SVM>>LR >>kNN

### SONUÇLAR

Bu çalışmada, sınıflandırma problemlerinin çözümünde, karar verme sürecine katkı sağlayacağı düşünülen bir hibrit sınıflandırma yaklaşımı önerilmiştir. Veriden bilgi elde etmeye yönelik ENTROPY yöntemi ile değişken ağırlıkları objektif olarak belirlenmiştir. Ağırlıklandırılmış veri setine, LR, kNN, SVM ve RF sınıflandırma yöntemleri uygulanarak yöntemlerin performans ölçütleri hesaplanmıştır. Elde edilen değerlere göre sınıflandırma yöntemlerinin tercih sıralaması, MCDM yöntemleri (TOPSIS, EDAS ve GRA) ile belirlenmiştir. Çalışmada önerilen hibrit sınıflandırma yaklaşımının uygulanabilirliğinin gösterilmesi amacıyla Ar-Ge ve Tasarım merkezlerine ait gerçek bir veri seti kullanılmıştır. Uygulama sonucunda RF>>SVM>>LR>>kNN biçiminde veri madenciliği sınıflandırma yöntemlerinin tercih sıralamasına ulaşılmıştır.

### Referanslar

- Anonim. 2016. T. C. Resmî Gazete, Araştırma ve Geliştirme Faaliyetlerinin Desteklenmesi Hakkında Kanun ile Bazı Kanun Hükmünde Kararnemelerde Değişiklik Yapılmasına Dair Kanun, No: 29636. Ankara.
- Arlı, N. B., Gürsakal S. ve Engin, M. 2022. Denetimli Makine Öğrenmesi Algoritmaları R ve Python Uygulamaları. Nobel Akademik Yayıncılık, 294 s., Ankara.
- Burkov A. 2021. The Hundred-Page Machine Learning Book kitabından çeviri, Çeviren: Okatan A., Karatekin T. ve K. Okatan, K. 2021. 100 Sayfada Makine Öğrenmesi Kitabı, Papatya Yayıncılık Eğitim, 134 s., İstanbul.
- Cortes, C. and Vapnik, V. 1995. Support Vector Networks. Machine Learning, 20(3), 273-297.
- Deng, J. 1982. Control Problems of Grey System. Systems and Control Letters, 5, 288-94.
- Erden, C. 2021. Python ile Veri Madenciliği. Kodlab Yayınevi, 290 s., İstanbul.
- Fayyad, U., Piatetsky-Shapiro, G., and Smyth, P. 1996. From Data Mining to Knowledge Discovery in Databases. AI Magazine, 17(3), 37-37.
- Geron A. 2021. Scikit-Learn Keras ve TensorFlow ile Uygulamalı Makine Öğrenmesi. Çeviri. Buzdağı Yayınevi, 862 s., Ankara.



- Ghorabae, M.K, Zavadskas, E. K., Olfat, L., and Turskis, Z. 2015. Multi-Criteria Inventory Classification Using a New Method of Evaluation Based on Distance from Average Solution (EDAS). *Informatica*, 26(3), 435-451.
- Hwang, C. L. and Yoon, K. 1981. *Multiple Attribute Decision Making: Methods and Applications*. Springer- Verlag, 228 p., New York.
- Kabak, M. ve Çınar, Y. 2020. *Çok Kriterli Karar Verme Yöntemleri: Ms Excel ® Çözümlü Uygulamalar*. Nobel Akademik Yayıncılık, 127 s., Ankara.
- Kumar, A., Singh, S. S., Singh, K., and Biswas, B. 2020. Link Prediction Techniques, Applications, and Performance: A Survey. *Physica A: Statistical Mechanics and its Applications*, 553, 124289.
- Özçalıcı, M. 2017. *Matlab ile Çok Kriterli Karar Verme Teknikleri*. Nobel Akademik Yayıncılık, 566 s., Ankara.
- Shannon, C. E. 1948. A Mathematical Theory of Communication. *The Bell System Technical Journal*, 27(3), 379-423.
- Sorhun, E. 2021. *Python ile Makine Öğrenmesi*. 464 s., Abaküs Kitap, İstanbul.
- Türkşen, Ö. 2023. *Optimizasyon Yöntemleri ve Matlab, Python, R Uygulamaları*. Nobel Akademik Yayıncılık, 468 s., Ankara.
- Uğuz, S. 2021. *Makine Öğrenmesi Teorik Yönleri ve Python Uygulamaları ile Yapay Zekâ Ekolü*. Nobel Akademik Yayıncılık, 298 s., Ankara.
- Vafaei, N., Ribeiro, R. A. and Camarinha-Matos, L. M. 2022. Assessing Normalization Techniques for Simple Additive Weighting Method. *Procedia Computer Science*, 199, 1229-1236.
- Xie, S. and Zhang, J. 2023. TOPSIS-based Comprehensive Measure of Variable Importance in Predictive Modelling. *Expert Systems with Applications*, 120682.

#### **Teşekkür**

Bu çalışma, Gözde Ulu Metin'in doktora tezinden üretilmiştir. Sanayi ve Teknoloji Bakanlığı Ar-Ge Teşvikleri Genel Müdürlüğü Ar-ge ve Tasarım Merkezleri Dairesi Başkanlığı'na veri paylaşımından dolayı teşekkür ederim.

#### **Çıkar Çatışması**

Yazarlar çıkar çatışması olmadığını beyan etmişlerdir.

#### **Yazar Katkıları**

Gözde Ulu Metin, veri temini, veri analizi, teorik açıklamaları hazırlamış olup Özlem Türkşen, bu aşamalarda çalışmaya bilgi, öneri, düzeltme ve yorumlarıyla katkı sağlamıştır.

## Prediction of Compaction Parameters From Soil Index Properties By Using Multiple Regression Analysis

Esra Tathloğlu<sup>1\*</sup>, Firdevs Uysal<sup>1</sup>

<sup>1</sup> Niğde Ömer Halisdemir University, Department of Civil Engineering, 51240, Niğde, Türkiye

\*Corresponding author e-mail: esratatlioglu@ohu.edu.tr

### Abstract

Soil compaction is an important application used to modify the engineering properties of compacted soils. The optimum moisture content (OMC) and maximum dry density (MDD) obtained from the laboratory proctor test are the compaction parameters used to evaluate the strength and permeability properties of the soil, especially for embankment construction. Determination of the OMC and MDD from the laboratory proctor test takes a relatively long time and requires large amounts of soil. Estimating OMC and MDD from more easily obtainable parameters such as consistency limits (liquid limit, plastic limit and plasticity index) will be especially convenient for application engineers. This study aims to predict the OMC and MDD of compacted fine-grained soil with statistical analysis by using the IBM SPSS-v20.0 program. For this purpose, the relationship between the consistency limits and the compaction parameters of the compacted fine-grained soil was examined. The selected variables for the developed equations are liquid limit (LL), plastic limit (PL), plasticity index (PI), OMC, and MDD. In this study, two soil groups classified as CL and CH in the unified classification system (USCS) were studied separately. Empirical correlations were developed as a result of multiple linear regression (MLR) analyses. Four correlations were obtained where the LL, PL, and PI are the independent variables, and the OMC and MDD values are the dependent variables. The success of the developed correlations in obtaining the OMC and MDD with LL, PL, and PI is explained by strong correlations ( $R=0.72-0.79$ ). These correlations are important in civil engineering applications in terms of obtaining compaction parameters with certain accuracy and in a short time.

**Keywords:** SPSS, Multiple Regression Analysis, Compaction Parameters, Consistency Limits, Fine-grained soil

### INTRODUCTION

Soil is fundamental in structures like buildings, bridges, highways, tunnels, and dam construction, influencing foundation design, structural stability, drainage, material selection, and environmental considerations (Roy and Bhalla, 2017). Soil provides the base upon which structures are built. The stability and load-bearing capacity of the soil determines the type of foundation needed for a building. Different soil types have different strengths and compositions, influencing the construction process. Soil type, soil parameters, structure of the soil or the way it is formed are very effective parameters on soil strength. In order to check the suitability of the soil to be used as a foundation or construction material, soil properties are required to be evaluated.

Earth embankments, dams, dykes, and railway formations are critical infrastructural projects that rely heavily on the stability and strength of the materials used in their construction (Farooq et al. 2016). Soil compaction is crucial in the construction of these structures. Soil compaction is the process of increasing the density of soil by reducing air voids between soil particles. This densification improves the soil's load-bearing capacity, reduces settlement, and enhances stability. Proper compaction ensures that the soil can withstand the stress without settling or collapsing. Parameters like dry unit weight, moisture content, and compaction effort are essential for assessing soil compaction (Khatti and Grover, 2023).

The Standard Proctor Test is a standardized laboratory method used to determine the optimum moisture content (OMC) and maximum dry density (MDD) of a soil for compaction (Spagnoli and Shimobe, 2020). Proctor tests can be time-consuming and require a significant amount of soil. However, this test provides essential information for designing and evaluating the compaction of soils used in construction projects, such as road dams, foundations, and earthworks (Ratnam and Prasad, 2019).

Estimating soil parameters using statistical analyses involves leveraging mathematical techniques to model relationships between various soil properties and the parameters of interest. Predicting compaction parameters from consistency limits is helpful approach of geotechnical engineering, especially in projects like dam complexes where soil behavior plays a significant role in the stability and performance of the structure. Researchers often develop empirical equations or models based on experimental data to predict compaction parameters (OMC and MDD) for different types of soil. These equations may take into account factors such as soil composition, gradation, mineralogy, and plasticity index (Günaydın 2009, Mujtaba et al. 2013; Karimpour-Fard et al. 2019). It should be noted that for fine-grained soils, consistency limits have significant effects on compression properties (Farooq et al. 2016). Advancements in technology have also led to provide engineers with additional tools for predicting OMC and MDD. Several statistical methods (Regression Analysis, Correlation Analysis, Anova, Principal Component Analysis, Machine Learning Algorithms, Cross-Validation) are commonly used to predict compaction parameters in geotechnical engineering (Khatti and Grover, 2023). Overall, the choice of statistical method depends on factors such as the nature of the data, the complexity of the relationships involved, and the specific objectives of the analysis. Researchers often employ a combination of techniques to develop robust predictive models for compaction parameters in geotechnical engineering.

Regression analysis is a powerful statistical tool commonly used to establish relationships between datasets, including predicting compaction parameters of soil (Kurnaz et al. 2016). This study utilizes MLR to predict dependent variables (OMC and MDD) from independent variables (LL, PL and PI). In this study, the experimental results of 86 soil specimens collected from the literature for CH-MH and CL-ML soils were used. The statistical results show that the developed correlations in obtaining OMC and MDD from LL, PL and PI is strong. By understanding and exploiting these strong correlations, researchers can develop practical and robust methods for estimating OMC and MDD, which are essential for soil compaction and engineering design.

## **MATERIAL AND METHODS**

### **Material**

First, a data set was created to carry out statistical analyses. In this study, database was created by collecting 86 sets of consistency limit tests and standard Proctor compression test data by taking into account only fine-grained soils (C and M) from sources accepted in the literature (Sivri, 2009; Günaydın, 2011). This data set includes the OMC, MDD, LL, PL and PI parameters of soil sample. PI is derived from the consistency limits, and it indicates the range of moisture content over which the soil behaves as a plastic material. In this study, it was decided to separate the data into two groups based on plasticity properties that are in general considered to be important in evaluating soil behavior. These groups are CH-MH and CL-ML. (**Table 1**).

### **Methods**

#### *Normality Test of the Data*

Normality tests play a critical role in ensuring the validity, reliability, and interpretability of statistical analyses (Tabachnick and Fidell, 2013). In parametric statistical analyses, it is necessary for the



variables to show a normal distribution in order to the analysis results to be acceptable. In this study, Kolmogorov-Smirnov test, descriptive statistics and graphical methods were used to investigate the normality of the parameters. When the p-value (Sig.) from the Kolmogorov-Smirnov test is greater than 0.05, it indicates that the data are likely normally distributed. However, the interpretation of normality tests should be considered alongside other evidence, such as graphical methods and descriptive statistics, to ensure a comprehensive assessment of normality (Pallant, 2005).

**Table 1.** Data set classification and numbers used in MLR analyses.

Soil type	Günaydın (2011)	Sivri (2009)	Total
CH-MH	31	16	47
CL-ML	-	39	39

#### Normality Tests of CL-ML Data

The normality tests of the variables were conducted using the SPSS program, and only variables demonstrating normal distribution were considered for analyses and evaluation. The Kolmogorov-Smirnov and Shapiro-Wilk normality tests were applied to the variables using the SPSS program (Table 2).

**Table 2.** Normality test results for CL-ML

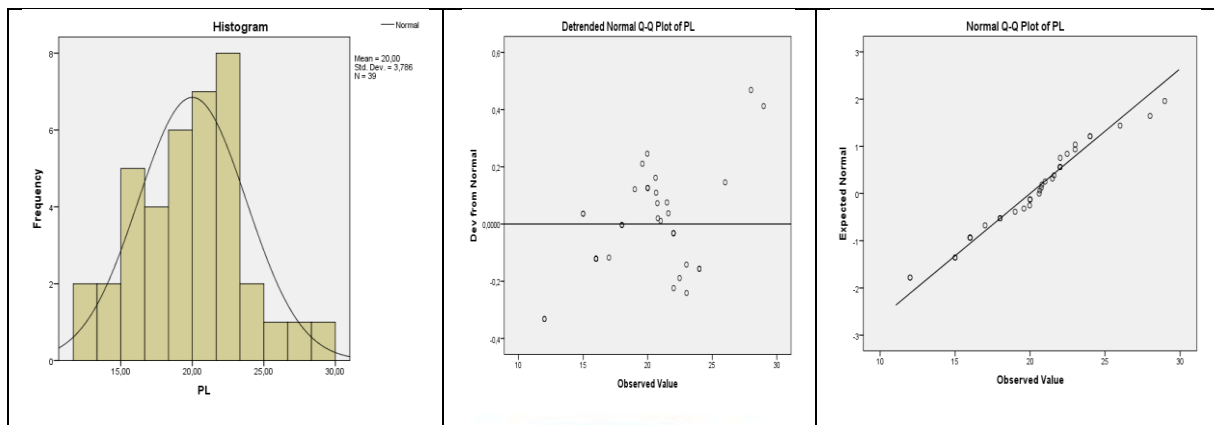
	Kolmogorov-Smirnov			Shapiro-Wilk		
	Statistic	df	Sig.	Statistic	df	Sig.
LL	0,116	39	0,200	0,944	39	0,052
PL	0,112	39	0,200	0,972	39	0,428
PI	0,099	39	0,200	0,950	39	0,082

From Table 2, it is observed that Sig-values for Kolmogorov-Smirnov test are high than level of significance 0.05. According to Kolmogorov-Smirnov test result, LL, PL and PI parameters show a normal distribution. Also, as seen from the results given below, both the skewness and kurtosis values are in the range of  $\pm 1.5$ . Two components of normality are skewness and kurtosis in descriptive statistics. Both the skewness and kurtosis values indicate the normality (Table 5), (Tabachnick and Fidell, 2013).

**Table 3.** Descriptive Statistics of CL-ML data.

Soil type	LL	PL	PI
N	39	39	39
Minimum	27,30	12,00	7,33
Maximum	48,00	28,98	27,00
Mean	37,34	19,99	17,34
Std. Deviation	6,23	3,78	5,61
Variance	38,88	14,33	31,47
Skewness	0,079	0,029	-0,233
Kurtosis	-1,302	0,280	-0,743

The suitability of the data set for normal distribution was investigated by histogram, Normal Q-Q Plot and Detrended Normal Q-Q Plot. A histogram is often used to see the distribution of a variable, and in particular to assess the statistical normality of a variable's distribution. When a histogram's shape approximates a bell curve, the data is considered come from a normal population (Elliott and Woodward, 2016). In Figure 1, the normality research of the PL variable belonging to the CL-ML data was examined by graphical methods and it was observed that the variable has to normal distribution.



**Figure 1.** Normality test results with graphical methods of PL variable of CL-ML data.

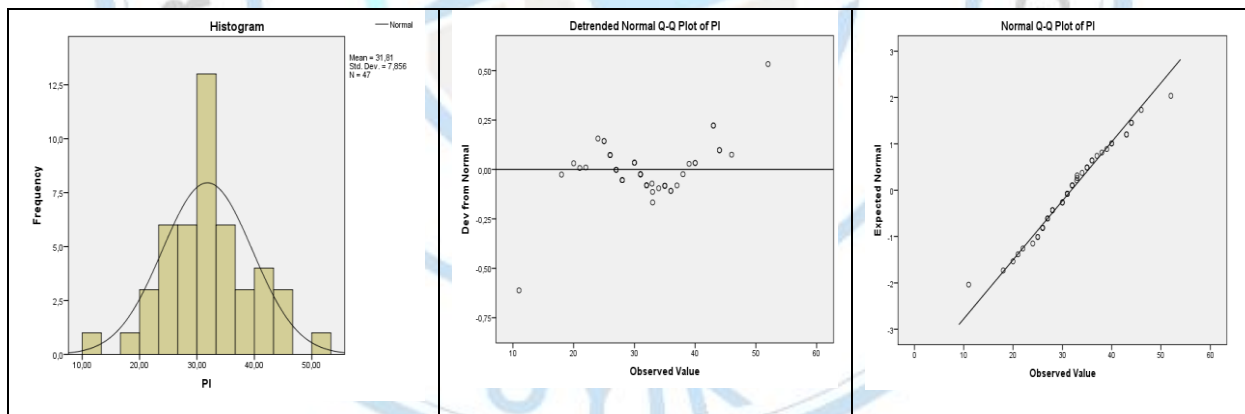
#### Normality Tests of CH-MH Data

Normality of variables is assessed by either statistical or graphical methods. The Kolmogorov-Smirnov and Shapiro-Wilk normality tests were applied to the variables of CH-MH data (Table 4).

**Table 4.** Normality test results for CH-MH

	Kolmogorov-Smirnov			Shapiro-Wilk		
	Statistic	df	Sig.	Statistic	df	Sig.
LL	0,130	47	0,046	0,895	47	0,000
PL	0,154	47	0,007	0,945	47	0,027
PI	0,078	47	0,200	0,989	47	0,930

According to Kolmogorov-Smirnov test result, LL and PI show a normal distribution. Also, both the skewness and kurtosis values and graphical methods indicate the normality (Table 5), (Tabachnick and Fidell, 2013).



**Figure 2.** Normality test results with graphical methods of PI variable of CH-MH data.

The suitability of the data set for normal distribution was investigated by histogram, Normal Q-Q Plot and Detrended Normal Q-Q Plot. In Figure 2, the normality research of the PI variable belonging to the CH-MH data was examined by graphical methods and it was observed that the variable has to normal distribution. The histogram is shaped like a bell curve. Detrended Normal Q-Q Plot shows a distribution that does not depend on any function. In Normal Q-Q Plot the observed value for each data is plotted against the expected value from the normal distribution. A straight line suggests a normal distribution. It is observed that the data is around the normal distribution line (Figure 2).

**Table 5.** Descriptive Statistics of CH-MH data.

Soil type	LL	PL	PI
N	47	47	47
Minimum	50	19	11
Maximum	89	43	52
Mean	61,06	29,25	31,80
Std. Deviation	9,80	6,63	7,85
Variance	96,20	44,006	61,71
Skewness	1,020	0,524	0,091
Kurtosis	0,399	-0,512	0,546

### Multiple Regression Analysis

The aim of this study was to identify the most suitable correlation for assessing soil compaction parameters based on the consistency limits of the soil. Correlations were created with multiple regression analysis using SPSS.

### Regression Analyses of CL-ML Data

The results of the regression analysis performed with the SPSS program using the values of the determined variables are presented in Table 6, Table 7 and Table 8. According to the results obtained, the multiple correlation coefficients between the dependent variables MDD and OMC and the independent variables are shown by R (Table 6), the values of which are 0.789 and 0.760, respectively. The value in question shows the relationship between the dependent variable and all independent variables, and it is seen that this relationship is high in terms of the result obtained.

The determination coefficient  $R^2$  expresses how much of the change in the dependent variable is explained by the independent variable and is an optimistic estimate of how much the model fits into the universe. Generally, since the model does not fit the universe as it fits the sample from which it was taken, adjusted  $R^2$  (adjusted R square) can be used to better reflect the goodness of fit to the universe (Akgül and Çevik, 2003).

**Table 6.** Model summary of CL-ML Regression Analyses.

Dependent Variable	R	$R^2$	Adjusted $R^2$
MDD	0,789 <sup>a</sup>	0,622	0,601
OMC	0,760 <sup>b</sup>	0,578	0,554

a. Predictors: (Constant), PL, LL

b. Predictors: (Constant), PI, PL

Table 6 shows  $R^2$  of the first regression 0.622, which means 62.2% variation in dependent variable (MDD) is explained by independent variables (PP, LL). This value also shows that there is a medium-strength relationship between the dependent and independent variables, and when the adjusted  $R^2$  value is considered, it is seen that the power of explanation is 60%.

**Table 7.** ANOVA test of CL-ML Regression Analyses.

ANOVA				
Dependent Variable	Sum Of Squares	Mean Square	F	Sig.
MDD	0,218	0,109	29,675	0,000 <sup>a</sup>
OMC	159,274	79,637	24,608	0,000 <sup>b</sup>

a. Predictors: (Constant), PL, LL

b. Predictors: (Constant), PI, LL



**Table 7** tries to test overall goodness of fit of fitted regression model. From above table it can be concluded that the fitted model is significant as P value of F statistics is 0.00 and it is less than level of significance level ( $\alpha = 5\%$ ). As can be seen from the ANOVA table that the model created for both dependent variables is significant.

Coefficient table helps to determine the regression equation, the column Unstandardized Coefficients and its sub column 'B' provides the regression coefficients. In the regression established with the dependent variable MDD, first one is constant, second and third one is regression coefficient of PL and LL (**Table 8**). Also, the regression coefficient is significant as Sig-value (0.00) is less than level of significance level ( $\alpha = 5\%$ ).

**Table 8.** Coefficients of CL-ML Regression Analyses.

Model		Coefficients		t	Sig.
		Unstandardized Coefficients (B)	Standardized Coefficients (Beta)		
1 <sup>a</sup>	(Constant)	2,166		32,878	0,000
	PL	-0,016	-0,618	-5,358	0,000
	LL	-0,004	-0,282	-2,447	0,019
2 <sup>b</sup>	(Constant)	5,333		2,727	0,010
	PL	0,541	0,760	6,923	0,000
	PI	0,119	0,247	2,249	0,031

a. Dependent Variable: MDD

b. Dependent Variable: OMC

#### Regression Analyses of CH-MH Data

The results of the CH-MH regression analysis performed with the SPSS program using the values of the determined variables are presented in Table 9, Table 10 and Table 11. According to the results, the multiple correlation coefficients between the dependent variables MDD and OMC and the independent variables are shown by R (**Table 9**), the values of which are 0.725 and 0.748, respectively. **Table 9** shows  $R^2$  of the first regression 0.525, which means 52.5% variation in dependent variable (MDD) is explained by independent variables (PI, LL).

**Table 9.** Model summary of CH-MH Regression Analyses.

Model	R	$R^2$	Adjusted $R^2$
MDD	0,725 <sup>a</sup>	0,525	0,503
OMC	0,748 <sup>b</sup>	0,559	0,539

a. Predictors: (Constant), PI, LL

b. Predictors: (Constant), PI, LL

As can be seen from the ANOVA table, the model created for both dependent variables are significant because the significance values are less than  $\alpha = 5\%$  (**Table 10**).

**Table 10.** ANOVA test of CH-MH Regression Analyses.

Dependent Variable	ANOVA			
	Sum Of Squares	Mean Square	F	Sig.
MDD	0,500	0,250	24,321	0,000 <sup>a</sup>
OMC	1110,734	555,367	27,939	0,000 <sup>b</sup>

a. Predictors: (Constant), PI, LL

b. Predictors: (Constant), PI, LL

The regression coefficients for the regressions created for CH-MH are shown in Table 11. In addition, since the Sig value (0.00) is less than the significance level ( $\alpha = 5\%$ ), it can be said that the regression coefficients are significant.

**Table 11.** Coefficients of CH-MH Regression Analyses.

Model		Coefficients			
		Unstandardized Coefficients (B)	Standardized Coefficients (Beta)	t	Sig.
1 <sup>a</sup>	(Constant)	2,130		22,409	0,000
	LL	-0,014	-0,952	-6,172	0,000
	PI	-0,007	0,366	2,374	0,022
2 <sup>b</sup>	(Constant)	-5,318		-1,273	0,210
	LL	0,667	0,995	6,699	0,000
	PI	-0,338	-0,404	-2,718	0,009

a. Dependent Variable: MDD

b. Dependent Variable: OMC

## RESULTS

A database consisting of 86 data sets containing consistency limit and compaction tests was used to conduct a statistical study to determine suitable correlations for estimating compaction parameters. For this purpose, various multiple linear regression models were investigated, and a parametric study was carried out to obtain the most suitable and practically applicable relationships. The correlation coefficients given in **Table 12** were determined based on multiple linear regression models. In this table, soil types, the multiple correlation coefficient R and adjusted R<sup>2</sup> values of equations are given together with the regression equation. As can be observed in this table, LL, PL and PI have a high correlation coefficient value for the two soil groups considered in evaluating the OMC and MDD.

**Table 12.** Results of Regression Analyses.

Model	Soil Type	Equation of Model	R(%)	Adjusted R <sup>2</sup>
1	CL-ML	OMC=5,333+0,541 PL+0,119 PI	0,760	0,554
2	CL-ML	MDD=2,166-0,16PL-0,004LL	0,789	0,601
3	CH-MH	OMC=-5,318+0,667LL-0,338PI	0,748	0,539
4	CH-MH	MDD=2,130-0,014+0,007PI	0,725	0,503

## DISCUSSION AND CONCLUSION

This study aimed to determine meaningful multiple regression models for the estimation of soil compaction parameters. These correlations are important in civil engineering applications in terms of obtaining compaction parameters with certain accuracy and in a short time. Using these equations derived from statistical analysis, engineers can expedite the determination of compaction parameters, resulting in both time and cost savings in soil mechanics projects. One of the important findings of our study is the high correlation observed between the compaction parameters and consistency limits in fine-grained soils. Future research could further expand and deepen knowledge in this area with analyses conducted on more comprehensive datasets.

## References

- Akgül A, Çevik O, 2003. İstatistiksel Analiz Teknikleri “SPSS’te İşletme Yönetimi Uygulamaları”, Emek Ofset, Ankara.
- Elliott AC, Woodward WA, 2016. IBM SPSS by Example: A Practical Guide to Statistical Data Analysis. SAGE Publications, Inc.

- Günaydın O, 2009. Estimation of soil compaction parameters by using statistical analyses and artificial neural networks. *Environmental Geology*, 57, 203-215. <https://doi.org/10.1007/s00254-008-1300-6>
- Farooq K, Khalid U, Mujtaba H, 2016. Prediction of compaction characteristics of fine-grained soils using consistency limits. *Arabian Journal for Science and Engineering*, 41, 1319-1328. <https://doi.org/10.1007/s13369-015-1918-0>
- Pallant J, 2005. *SPSS Survival Manual: A step by step guide to data analysis using SPSS for Windows*. Allen & Unwin.
- Karimpour-Fard M, Machado SL, Falamaki A, Carvalho MF, Tizpa P, 2019. Prediction of compaction characteristics of soils from index test's results. *Iranian Journal of Science and Technology, Transactions of Civil Engineering*, 43, 231-248. <https://doi.org/10.1007/s40996-018-0161-9>
- Khatti J, Grover KS, 2023. Prediction of compaction parameters for fine-grained soil: Critical comparison of the deep learning and standalone models. *Journal of Rock Mechanics and Geotechnical Engineering*, 15(11), 3010-3038. <https://doi.org/10.1016/j.jrmge.2022.12.034>
- Kurnaz TF, Dagdeviren U, Yildiz M, Ozkan O, 2016. Prediction of compressibility parameters of the soils using artificial neural network. *SpringerPlus* 5, 1801. <https://doi.org/10.1186/s40064-016-3494-5>
- Mujtaba H, Farooq K, Sivakugan N, Das BM, 2013. Correlation between gradational parameters and compaction characteristics of sandy soils. *International Journal of Geotechnical Engineering*, 7(4), 395-401. <https://doi.org/10.1179/1938636213Z.00000000045>
- Ratnam UV, Prasad KN, 2019. Prediction of compaction and compressibility characteristics of compacted soils. *International Journal of Applied Engineering Research*, 14(3), 621-632.
- Roy S, Bhalla SK, 2017. Role of geotechnical properties of soil on civil engineering structures. *Resources and Environment*, 7(4), 103-109. <https://doi.org/10.5923/j.re.20170704.03>
- Spagnoli G, Shimobe S, 2020. An overview on the compaction characteristics of soils by laboratory tests. *Engineering Geology*, 278, 105830. <https://doi.org/10.1016/j.enggeo.2020.105830>
- Tabachnick BG, Fidell LS, 2013. *Using Multivariate Statistics* (6th Ed.). Boston: Allyn & Bacon.

#### **Conflict of Interest**

The authors have declared that there is no conflict of interest.

#### **Author Contributions**

Esra Tathoğlu: Methodology, analyses, writing – original draft, editing. Firdevs Uysal: Methodology, writing – original draft, data curation, editing.



## An Analysis on Changing the Age Farmers in Türkiye Over Time

Aysel ERGÜN<sup>1</sup>, Faruk KOŞAK<sup>2\*</sup>, Esen ORUÇ<sup>3</sup>

<sup>1</sup>Department of Agricultural Economics, Agricultural Faculty, Tokat Gaziosmanpaşa University, 60250 Tokat, Türkiye

<sup>2</sup>School of Natural and Applied Science, Tokat Gaziosmanpaşa University, 60250 Tokat, Türkiye

<sup>3</sup>Department of Agricultural Economics, Agricultural Faculty, Tokat Gaziosmanpaşa University, 60250 Tokat, Türkiye

Corresponding author e-mail: aysel.ergun3018@gop.edu.tr

### Abstract

Rural areas, where the main economic activity in Turkey and the world is based on agriculture, and the population and demographic structure of the people living in these regions are extremely important in terms of increasing production and sustainability. It is frequently stated that the proportion of the elderly population in the rural population has increased in Turkey recently due to migration from rural areas. Micro studies reveal results such as the age ranges and average ages of farmers in the region where they are conducted. Studies based on micro-level primary data are extremely important in determining the age dynamics of agricultural business managers. It was decided to conduct this study, considering that by examining the results of micro level studies and combining the data obtained from many studies, it could create a profile about the age level of farmers throughout Turkey and its change over time. The aim of this study is to make a situation assessment on the age of farmers in Turkey by bringing together the results of research conducted in different rural regions and to analyze its change over time. The main material of the research consists of data on farmer age compiled from micro level studies for the periods 2000-2005 and 2019-2024 in different rural regions of Turkey. The study is a Meta-analysis study. In the study, the average values of the two periods were compared with the t-test. In addition to periodical differences in farmer ages, regional differences were also analyzed by ANOVA test.

**Keywords:** Rural area, Farmer age change, t test, ANOVA test, Meta Analysis.

### INTRODUCTION

The main economic growth of rural development is based on agriculture. The demographic structure of the people living in these areas is extremely important in terms of increasing and sustaining agricultural production and ensuring food security. Young people moving away from agriculture makes agriculture independent of the labor force of the elderly (Ergün and Oruç, 2023; Çağlayan et al., 2020; Demirbük, 2013). For this reason, studies on the aging problem that occurs in rural areas need to be accelerated. Although it is mostly mentioned in the studies that there is an increase in the age of farmers, a few studies also state that there is a decrease in the age of farmers (Sağlam and Boz, 2023; Altın and Demiryürek, 2021; Kurt and Boz, 2021). Although there are many studies stating that the average age of producers in the agricultural sector has increased and making evaluations on the negative consequences of this, no study has been found that comparatively reveals how age dynamics change over time, taking into account a time period. The aim of this study is to make a situation assessment on farmer age in Turkey and analyze its change over time by bringing together the results of research conducted in different rural regions and at two different periodical times.

## MATERIAL AND METHODS

The main material of this study consists of data on farmer age compiled from micro level studies for the periods 2000-2005 and 2019-2024 in different rural regions of Turkey. In the study, we tried to reach as many studies as possible and a comprehensive literature review was conducted. As a result of the literature review, data on the age level of agricultural business managers from more than 100 studies conducted in previous years were transferred to the computer environment. In the studies, average ages and percentage distributions of age ranges were taken. The study is a Meta Analysis study as a method. Meta-Analysis is a method of combining the results of multiple independent studies on a specific subject and performing statistical analysis of the obtained research findings. Such analysis can guide policy makers and rural development experts in understanding changes in the age structure of the farmer population and developing appropriate strategies. The average age and percentage distribution of age ranges for the two periods were evaluated through descriptive statistics and compared based on these values. Additionally, data from the two periods were compared by t test. Regional differences in farmers' ages were also analyzed through ANOVA test.

The micro level studies examined within the scope of the study are given in Table 1 and Table 2.

**Table 1.** Resources examined for the period 2000-2005

Number	Resources
1	Acar İ., Yıldırım İ., 2000.
2	Akçaöz H., Özkan B., Kızılay H., 2005.
3	Akçay Y., Çiçek A., Uzunöz M., Sayılı M., 2000.
4	Aslan M., Boz İ., 2005.
5	Aktürk D., Savran F., Hakyemez H., Daş G., Savaş T., 2005.
6	Boz İ., Akbay C., Orhan E., Candemir S., 2004.
7	Gaytancıoğlu O., Bayraktar E., Tavit S., 2000.
8	Gündüz O., Akay M., 2003.
9	İnan H., Boyraz N., 2000.
10	Karabaş S., 2004.
11	Kaptaner H., 2003.
12	Karkacier O., Gülse S., Oruç E., Göktolga, G., 2000.
13	Kaçıra Ö., Karlı B., 2004.
14	Kızılaslan N., Almus S., 2000.
15	Kızılaslan H., Kızılaslan N., 2005.
16	Odacıoğlu Ş. G., Çiçek A., 2000.
17	Oruç E., 2001.
18	Özkan B., Akçaöz H., Karadeniz Yavuz C. F., 2002.
19	Şahin A., Çakır C., Yıldırım İ., 2004.
20	Tanrıvermiş H., 2000.
21	Torun E., Taluğ C., 2005.
22	Uzmay A., Durmaz S., Örümlü A.E., 2001.

**V. International Applied Statistics Congress (UYİK - 2024)**  
**Istanbul / Turkey, May 21-23, 2024**

**Table 2.** Resources examined for the period 2019-2024

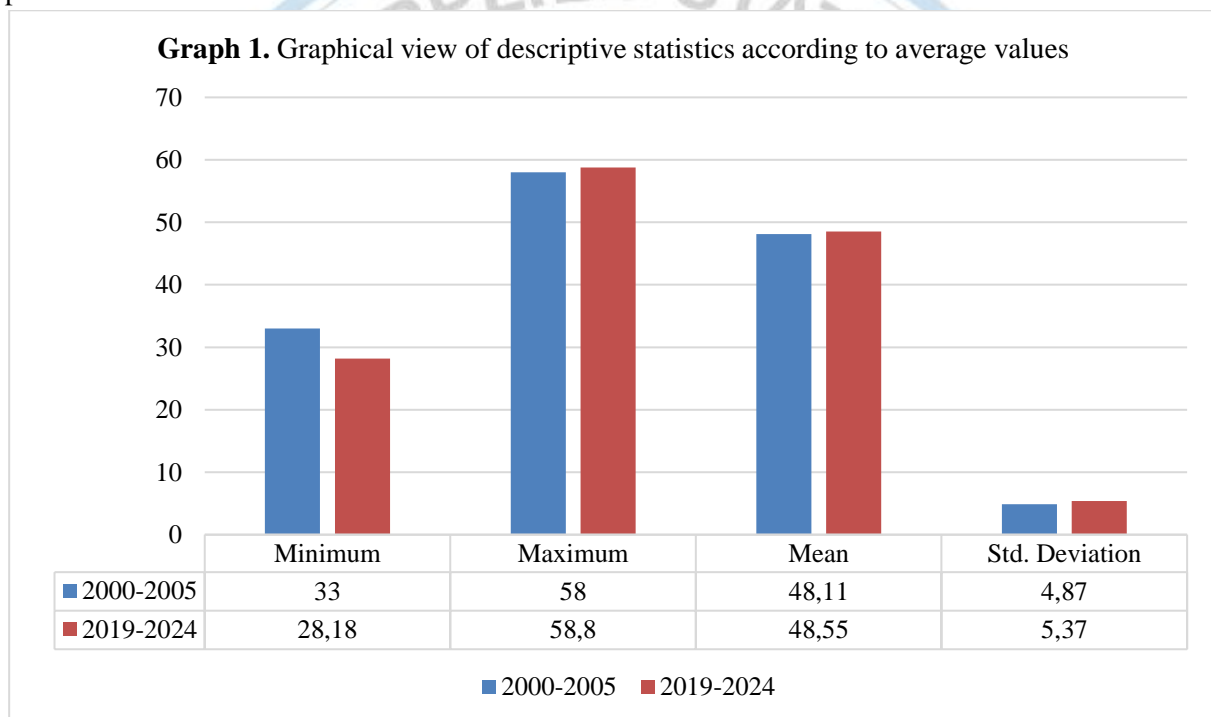
Number	Resources	Number	Resources
1	Akçalı A., Boz İ., 2022.	47	İşçi B., Söyler K., Altındişli A., Boyacı M., 2019.
2	Akış N., Aksoy A., 2023.	48	Kaplan K., Kaplan E., Bal H.S.G., 2019.
3	Altın Ö., Demiryürek K., 2021.	49	Karakaya E., 2019.
4	Altıntaş G., Altıntaş A., Bektaş H., Çakmak E., Oruç E., Kızılaslan H., Birol D., 2019.	50	Katipoglu P., Armağan G., 2020.
5	Altuntaş B., 2021.	51	Kaya N., Çoker S., Kınıklı F., Yercan M., 2019.
6	Aral C., Kılıç H., Karakaya E., 2023.	52	Kepenek Y.S., 2019.
7	Aritunca D., Karabacak A., 2019.	53	Kılıç O., Aydın Eryılmaz G., Çakır S., 2021.
8	Ayalp S., 2020.	54	Kılıçer E., 2019.
9	Aydın Eryılmaz G., Kılıç O., 2021.	55	Kızılaslan N., Kızılaslan H., Solmaz E., 2021.
10	Aydın Y.K., 2020.	56	Köksal H., 2019.
11	Aydinoğlu M. H., 2020.	57	Kurt Y. A., Boz İ., 2021.
12	Aydoğdu M.H., Altun M., 2019.	58	Mavioğlu M.N., Çobanoğlu F., 2019
13	Bayraktar A., Boz İ., 2020.	59	Memiş H., Akgül K., 2021.
14	Baytar İ., Doğan M., 2022.	60	Öcal Kara F., Binici T., 2021.
15	Berk A., 2019.	61	Özbek H., 2019.
16	Beşen T., Sayın B., Kuzgun M., Karamürsel D., 2021.	62	Özdemir Y., Kınıklı F., Engindeniz S., 2021.
17	Birsin S., Kızılaslan, H., 2023.	63	Özel R., Sağlam N., 2022.
18	Bozan H., 2020.	64	Özer B., Tümer İkikat E., 2021.
19	Çağlayan Z. C., Göktaş İ., Örmeci Kart M.Ç., Gümüş S., 2020.	65	Özer D., İkikat Tümer E., 2020.
20	Çankaya D., Boz İ., 2023.	66	Öztürk F., Kılıç H., Karakaya E., 2023.
21	Çetinkaya S., Aytıp Y., 2023.	67	Sağlam F., Boz İ., 2023.
22	Çıkılı G., 2019.	68	Salalı E., Atış E., Günden C., 2019.
23	Çiçekgil Z., Ataseven Y., 2021.	69	Sarı Gedik D., 2019.
24	Çiftçi K., Miran B., Kanberoğlu Z., 2019.	70	Satılmış A.S., Kul E., 2023.
25	Değer H.C., Özder U., Kınıklı F., Yercan M., 2020.	71	Sayın B., Bayav A., Beşen T., Karamürsel D., 2020.
26	Demir Y., 2019.	72	Solmaz E.E., Özdemir H.Ö., 2021.
27	Demirbük M., Ayyıldız B., 2021.	73	Sönmez S., Artukoğlu M., 2021.
28	Doğan B., İkikat Tümer E., 2019.	74	Şenol E., 2019.
29	Doğan Öz B., Saner G., 2020.	75	Şenyüz E., Bahşi N., 2023.
30	Dönmez Özyakar H., Yılmaz H., 2021.	76	Şimşek Y.B., Armağan G., 2020.
31	Erdal G., Erdal H., Ayyıldız B., Ayyıldız M., Çiçek A., 2019.	77	Tapkı N., Öztornacı B., Kantar Davran M., 2021.
32	Ergün A., Oruç E., 2023.	78	Taşcı R., Tarhan S., Söylemez E., Özercan B., 2023.
33	Everest B., Yavaş A., Tatar E., Acar İ., Çakar F., 2019.	79	Tolunay A., Akboğa İ., Özmiş M., 2023.
34	Eydemir Ö., 2019.	80	Topal E., Adanacioğlu H., Karaman S., Kösoğlu M., 2020.
35	Gözener B., Yüksel M., 2019.	81	Topbaş N. T., 2019.
36	Gülse Bal H., Yüzbasıoğlu R., Gürel E., 2019.	82	Torgut E., Annayev S., Örmeci Kart M. Ç., Türkekul B., 2019.
37	Gültekin R., İkikat Tümer E., 2021.	83	Turan B., Demircan V., 2021.
38	Gündüz O., Aslan A., Ceyhan V., Bayramoğlu Z., 2020.	84	Uzun T., 2021.
39	Gündüz O., Aslan A., Yıldırım Ç., 2023.	85	Ünal S. A., İkikat Tümer E., 2021.
40	Gür O., 2019.	86	Veziroğlu P., Emeksiz F., 2020.
41	Gürbüz İ.B., Kadağan Ö., 2019.	87	Yıldız A.K., Ayyıldız M., Ayyıldız B., Arslan S., 2022.
42	Güven O., Yavuz F., 2020.	88	Yılmaz E., Özdemir G., Oraman Y., Unakıtan G., Konyalı S., 2019.
43	İrmak E., 2019.	89	Yılmaz E., Turğut U., Tosun D., Gümüş S., 2020.
44	İşık V., Öztornacı B., 2019.	90	Yiğit B., 2022.
45	İkikat Tümer, E., Ağır H. B., Uslu Z., 2019.	91	Yüzbaşıoğlu R., 2019.
46	İnan S., Erdal H., Erdal G., 2022.	92	Yüzbaşıoğlu R., Kızılaslan H., 2020.



## RESULTS

By combining the average ages of farmers revealed by the research, the average and standard deviation were calculated for the two periods compared and the minimum and maximum ages for each period were determined and visualized graphically. Graph 1 shows the mentioned values according to the average age values.

According to Graph 1, the lowest average age among the micro studies conducted in rural areas between 2000 and 2005 was 33 and the highest was 58. In studies conducted between 2019 and 2024, the minimum average age is 28.2 and the maximum average age is 58.8. The average age values for studies between 2000-2005 are 48.1, and in the range of 2019-2024, this average is 48.6. It can be concluded that there is no significant change in the average age of farmers between the two periods, assuming that the average age values determined for different regions of Turkey as a result of numerous studies on periods will reflect the average age of farmers in Turkey for the relevant period. Minimum and maximum values also indicate that the farmer's age does not show a significant change between periods.



Standard deviation values of the averages reveal the difference or similarity of the research results within the coverage of the study. Although the standard deviation value is 0.5 higher for the second period (2019-2024), it is seen that the figures are quite close for the two periods. Accordingly, the results of the research conducted in different regions for both periods show an average deviation of around 5 from the average values.

It has been interpreted above that the average age of the two periods does not differ significantly based on the average, minimum, maximum and standard deviation values. Statistical analysis of the difference in average age values for the two periods was made by t test. With the analysis, it was concluded that the average age of farmers did not show a significant difference at the statistical level between 2000-2005 and 2019-2024.

Basic group statistics of period averages are given in Table 1 and t-test results regarding the periodical differences in age averages are given in Table 3. It is concluded that the variance is homogeneously distributed since the significance value of Levene's test is greater than 0.05. In this case, when looking at the equalvarianceassumed t test significance value ( $0.661 > 0.05$ ) in accordance with

the homogeneous distribution, it can be seen that the average ages of the two periods do not differ statistically (Table 4).

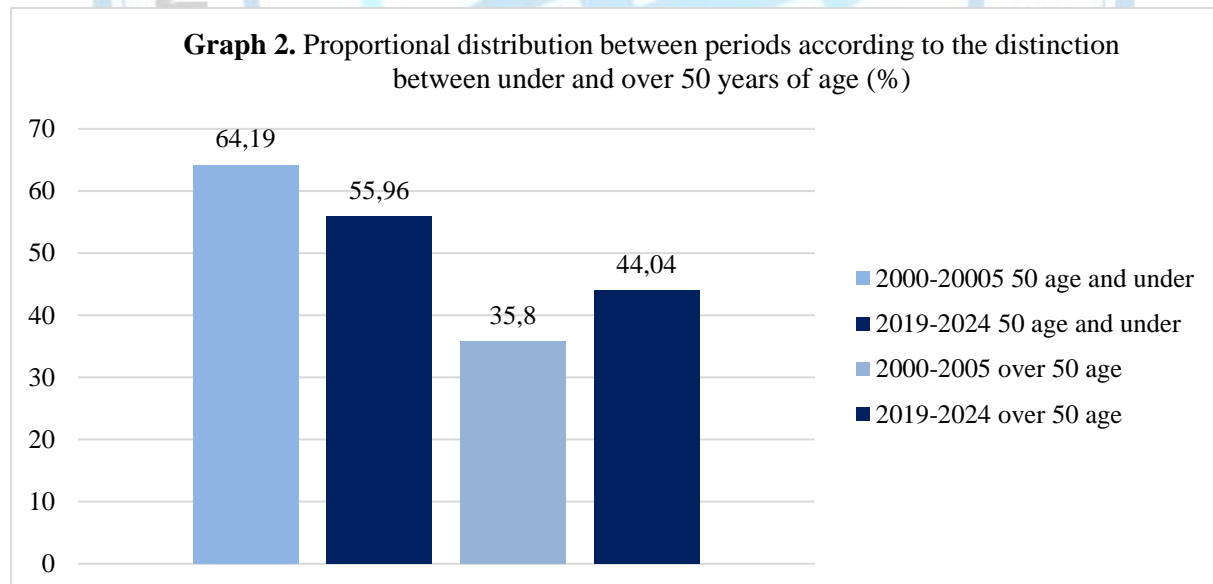
**Table 3.** Group statistics of age average values

	Periods	N	Mean	Std Deviation	Std. Error Mean
Average age values	Period 1	42	48,1133	4,87795	,75268
	Period 2	72	48,5564	5,37233	,63313

**Table 4.** t test on difference in age averages according to periods (2000-2005 and 2019-2025)

		Levene's Test for Equality of Variance		t-test Equality of Means						
		F	Sig.	t	df	Sig. (2-tailed)	Mean Difference	St. Error Difference	95% Confidence Interval of the Difference	
									Lower	Upper
Age average values	Equal variance assumed	,105	,746	-,439	112	,661	-,44306	1,00902	-2,4423	1,5562
	Equal variance not assumed			-,450	92,736	,653	-,44306	,98356	-2,3963	1,5102

An attempt was made to make an evaluation through the percentage distributions of the age ranges given in the studies examined. For the two periods considered, the rate of farmers aged 50 and younger was considered as another comparison criterion. Graph 2 reflects the rates of farmers under and over the age of 50 for two periods. As visually reflected in Graph 2, the proportion of farmers aged 50 and younger decreased by 8.23% in the second period, and this proportion shifted to those over 50 years of age. Whether this decrease was at a statistical level was analyzed by t test.



It was analyzed by t test whether the decrease mentioned in the previous paragraph was statistically significant. For this purpose, data was organized and sorted based on the percentage distributions of age ranges in the studies examined. Considering the data sets created, it was deemed appropriate to analyze the percentage of farmers under the age of 50 between the two periods. t Test results revealed that there was no statistically significant difference between the two periods in the percentage of farmers aged 50 and under (Sig. 0252>0.05).

**Table 5.** Group statistics of average percent age values of aged fifty and under

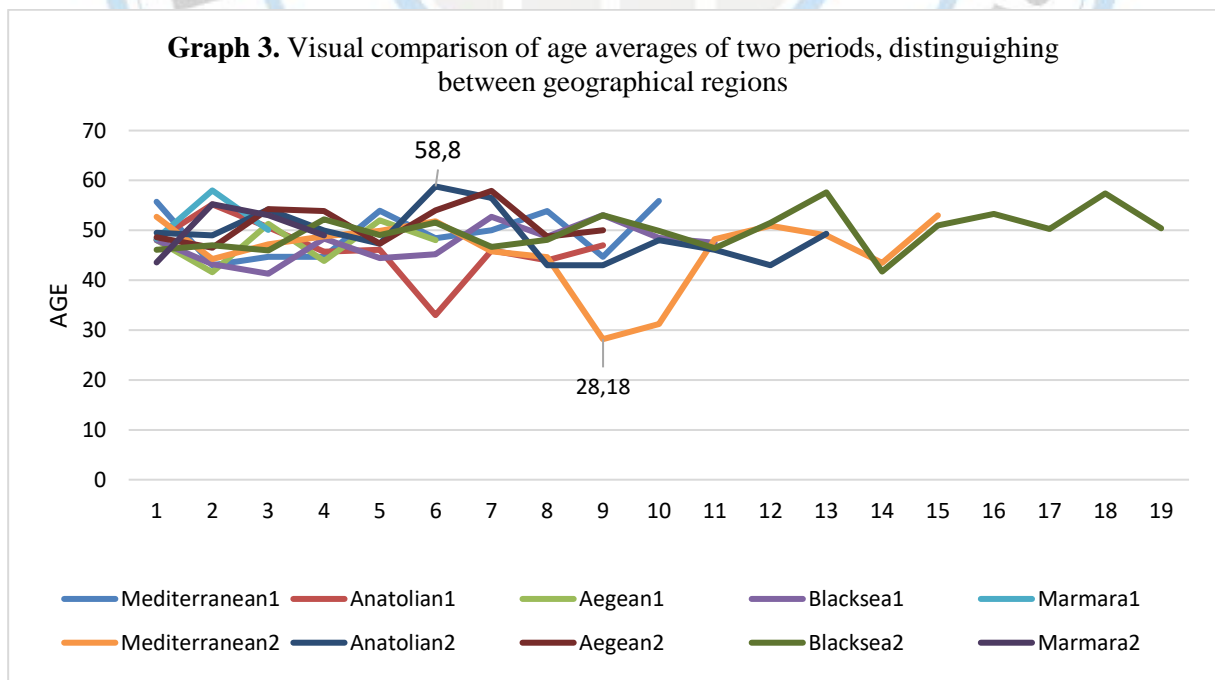
	Periods	N	Mean	Std Deviation	Std. Error Mean
Average percentage of aged fifty and under	Period 1	11	64,1945	18,74575	5,65206
	Period 2	9	55,9556	12,14506	4,04835

**Table 6.** t-Test on the difference in average percent age values of age difty and under according to periods

		Levene's Test for Equality of Variance		t-test Equality of Means						
		F	Sig.	t	df	Sig (2-tailed)	Mean Difference	St. Error Difference	95% Confidence Interval of the Difference	
									Lower	Upper
Average percentage of aged fifty and under	Equalvariance assumed	5,741	,028	1,135	18	,271	8,23899	7,25830	-7,0101	23,488
	Equalvariance not assumed			1,185	17,225	,252	8,23899	6,95233	-6,4145	22,893

Since the results of field research conducted in different regions of Türkiye were used in the study, it was also examined whether there were regional differences in terms of farmer age. Graph 5 aims to visualize the averages taken from the researches within the coverage of the study on a line graph. Each point in this graph shows the average age result of a study. Since sufficient studies could not be obtained for the Eastern Anatolia, Central Anatolia and Southeastern Anatolia Regions, these regions were evaluated by combining them with the Anatolia region. In the graph, it can be seen that the regional and periodical lines are similar and the average age values are within a certain range (40-60 age range).

The lowest average age belongs to the second period for the Mediterranean region. The highest average value belongs to the second period for the Anatolia region.





ANOVA test was used to make a statistical comparison of age averages, taking into account region and period. According to the ANOVA test, there is no significant regional difference between the average ages (Sig. 0.067>0.05). Findings regarding the ANOVA test are given in Table 7 and Table 8.

**Table 7.** Test of homogeneity of variances

Levrence Statistics	df1	df2	Sig.
0,757	11	87	,681

**Table 8.** ANOVA test on difference in age average values according to regions and periods

	Sum of Squares	df	Mean Square	F	Sig.
Between Groups	489,347	11	44,486	1,797	0,067
Within Groups	2153,500	87	24,753		
Total	2642,847	98			

## DISCUSSION AND CONCLUSION

Many studies conducted in the world and in Türkiye mention that the age of farmers is increasing and the rural population is aging. However, no scientific study has been found that reveals this age change over any year interval. Although the general opinion is that the farmers are getting older, as a result of this study, which was carried out on the average farmer age findings and percentage distributions of age ranges of micro level research between the two periods taken as 2000-2005 and 2019-2024, there is no a statistically significant increase in the age of farmers between the periods discussed. It was determined that there was no change. However, it is thought that more accurate results can be obtained regarding the change in the age parameters of agricultural business managers from past to present by going back to older years and conducting similar and more comprehensive studies covering a longer period.

As a result of this study, a result that does not coincide with the general opinion was reached. It is important that the arguments put forward in scientific studies are based on statistical results. It is not possible to say that the views on farmer age are based on the results of comprehensive and comparative analysis. To be able to say this requires strong research results on the subject. The age profile of those working in the agricultural sector should be evaluated within the age change of the general population.

## References

- Acar İ., Yıldırım İ., 2000. Mandıra İşleten Dönerdere Tarımsal Kalkınma Kooperatifine Ortak İşletmelerin Ekonomik Analizi. Yüzüncü Yıl Üniversitesi, Ziraat Fakültesi, Tarım Bilimleri Dergisi (J.Agric. Sci.), 2000, 10(1):61-70.
- Akçaöz H., Özkan B., Kızılay H., 2005. Tarımsal Üretimde Çiftçilerin Tutum ve Davranışları: Çiftçilik Amaçları Ölçeği (FOS). J. of AARI 15 (2) 2005, 104 - 125 MARA.
- Akçalı A., Boz İ., 2022. Çiftçilerin Ziraat Odasının Verdiği Danışmanlık Hizmetlerinden Memnuniyet Düzeyi: Samsun İli Terme İlçesi Örneği. ISPEC Journal of Agr. Sciences 6(2): 211-222, 2022.
- Akçay Y., Çiçek A., Uzunöz M., Sayılı M., 2000. Tokat İlinde Sözleşmeli Domates Yetiştiriciliğinin Karşılaştırmalı Ekonomik Analizi . Türkiye IV. Ulusal Tarım Ekonomisi Kongresi (pp.25-37). Tekirdağ, Türkiye.
- Akış N., Aksoy A., 2023. Tarımsal Eğitimin Çiftçiler Üzerine Etkisi: Atatürk Üniversitesi Örneği. Kahramanmaraş Sütçü İmam Üniversitesi Tarım ve Doğa Dergisi, 26(4), 902-911.
- Altın Ö., Demiryürek K., 2021. Analysis of the Use of Information and Communication Technologies in Agricultural Extension by Members of Agricultural Growers' Associations: Tokat Example. MAS Journal of Applied Sciences, 6(4), 844-959.

- Altıntaş G., Altıntaş A., Bektaş H., Çakmak E., Oruç, E., Kızılaslan H., Birol D., 2019. Genç Çiftçi Desteklemelerinin Gençlerin Tarımda Kalma Eğilimleri Üzerine Etkileri: TR-83 Bölgesi Örneği. *Türk Tarım - Gıda Bilim ve Teknoloji Dergisi*, 7(10), 1682-1693.
- Altıntaş B., 2021. Tarımsal Kooperatifçiliğin Gelişimi ve Kırşehir İlinin Tarımsal Kooperatifçilik Potansiyelinin SWOT Analizi ile Değerlendirilmesi. In *Ahi Evran International Conference on Scientific Research* (Vol. 30, pp. 938-949).
- Aral C., Kılıç H., Karakaya E., 2023. Bingöl İli Buğday Üretiminin Mevcut Durum Analizi. *Turkish Journal of Agriculture and Natural Sciences* 10(4): 960-976, 2023.
- Aslan M., Boz İ., 2005. Doğrudan Gelir Desteğinin Tarımsal Amaçlı Kullanımını Etkileyen Faktörler. *Tarım Ekonomisi Dergisi*, 11(1 ve 2), 61-70.
- Aritunca D., Karabacak A., 2019. Konya Merkez İlçelerinde Koyunculuk İşletmelerinin Durumu. *Journal of Bahri Dagdas Animal Research* 9 (1):13-24, 2020 e-ISSN: 2687-3745.
- Ayalp S., 2020. Şanlıurfa Damızlık Koyun Keçi Yetiştiricileri Birliği Üyelerinin Örgütsel Memnuniyetleri ve Beklentileri Üzerine Bir Araştırma. Yüksek Lisans Tezi, Harran Üniversitesi, Tarım Ekonomisi Anabilim Dalı, Şanlıurfa.
- Aydın Eryılmaz G., Kılıç O., 2021. Semt Pazarında Ürünlerini Satan Çiftçilerin Görüşleri ve Memnuniyet Durumları: Sinop İli Gerze İlçesi Örneği, Türkiye. *Türkiye Tarımsal Araştırmalar Dergisi*, 8(2), 228-234.
- Aydın Y.K., 2020. Antalya İli Serik ve Aksu İlçesindeki Domates Üreticilerinin Sosyo Ekonomik Durumu. Yüksek Lisans Tezi, Tokat Gazi Osmanpaşa Üniversitesi, Fen Bilimleri Enstitüsü, Tarım Ekonomisi Anabilim Dalı, Tokat, Türkiye.
- Aydınoglu M. H., 2020. A Research on Water Use Behaviors of Farmers in Agricultural Irrigation: Case of Şanlıurfa. *Electronic Journal of Social Sciences* Issn:1304-0278 Nisan/April(2020) - Cilt/Volume:19 - Sayı/Issue:74 (602-610).
- Aydoğdu M. H., Altun M., 2019. Mısır Ekimi Yapan Çiftçilerin Tarımsal Yayım ve Danışmanlık Hizmetleri İçin Ödemeye Yönelik Tutumları: Şanlıurfa Örnekleme. *Al Farabi Uluslararası Sosyal Bilimler Dergisi*, 3(2), 109-115.
- Bayraktar A., Boz İ., 2020. Samsun İli Çarşamba İlçesinde Çiftçilerin Tarımsal Mücadele İlaçları Kullanımında Çevreye Karşı Tutum ve Davranışları. *Turkish Journal of Agriculture - Food Science and Technology*, 8(2): 392-398, 2020.
- Baytar İ., Doğan M., 2022. Kırsal Alan Potansiyelinin Kırsal Kalkınmaya Etkisi Üzerine Nitel Bir Araştırma: Muş İli Örneği. *International Journal of Geography and Geography Education*(45), 239-265.
- Berk A., 2019. Niğde ve Karaman İllerinde Çiftçilerin Tarımsal Kredi Kullanım Kararlarını Etkileyen Faktörlerin Belirlenmesi. *Türk Tarım - Gıda Bilim ve Teknoloji dergisi*, 7(8), 1182 - 1188 10.
- Beşen T., Sayın B., Kuzgun M., Karamürsel D., 2021. TR61 Bölgesinde Genç Çiftçi Projesi Desteğinden Yararlanmayı Etkileyen Faktörlerin Değerlendirilmesi. *Uluslararası Tarım ve Yaban Hayatı Bilimleri Dergisi*, 7(1), 63-74.
- Birsin S., Kızılaslan, H., 2023. TR 22 Bölgesinde Zeytin ve Zeytinyağı Üreten İşletmelerin Başarı Durumunu Etkileyen Faktörlerin Analizi. *Gaziosmanpaşa Bilimsel Araştırma Dergisi*, 12(1), 157-166.
- Boz İ., Akbay C., Orhan E., Candemir S., 2004. Çiftçilerin Tarımsal Faaliyetlerde Kullandıkları Bilgi Kaynaklarının Belirlenmesi ve Tarımsal Yayım Açısından Değerlendirilmesi. *Türkiye IV. Tarım Ekonomisi Kongresi*, 16-18 Eylül 2004, Tokat.
- Bozan H., 2020. Antalya İlinde Genç Çiftçi Projesinden Yararlanan ve Yararlanmayan Kadınların Girişimcilik Eğilimlerinin Araştırılması. Yüksek Lisans Tezi, Akdeniz Üniversitesi, Fen Bilimleri Enstitüsü, Antalya.
- Çağlayan Z. C., Gökteş İ., Örmeci Kart M.Ç., Gümüş S. 2020. Evaluation of The Young Farmer Program in Terms of Animal Breeders: Case of Izmir, Ege Üniv. Ziraat Fak. Derg., Özel Sayı : 107-117.
- Çankaya D., Boz İ., 2023. Fındık Üreticilerinin İklim Değişikliği Konusunda Bilgi Düzeyleri, Deneyimleri ve Gelecekle İlgili Kararları. *ISPEC Journal of Agricultural Sciences (Online)*, 7(2), 395- 406.

- Çetinkaya S., Aytıp Y., 2023. Şanlıurfa İlinde Pamuk Üretim Memnuniyetininin Sürdürülebilirliğe Etkisinin Belirlenmesi. Tarım Ekonomisi Araştırmaları Dergisi (TEAD), Cilt:9 Sayı: 2, Sayfa: 185-205.
- Çıkkılı G., 2019. Sivas İli Merkez İlçede Hayvansal Üretim Yapan İşletmelerin Mevcut Durumu ve Kredi Kullanımının Belirlenmesi. Yüksek Lisans Tezi, Tokat Gazi Osmanpaşa Üniversitesi Fen Bilimleri Enstitüsü, Tarım Ekonomisi Anabilim Dalı, Tokat, Türkiye.
- Çiçekgil Z., Ataseven Y., 2021. "Sürü Yönetimi Elemanı Benim" Projesi Kapsamındaki Tarımsal Eğitim Faaliyetlerinin Analizi. Tarım Ekonomisi Araştırmaları Dergisi, 7(1), 52-65.
- Çiftçi K., Miran B., Kanberoğlu Z., 2019. Çiftçilerin Planlı Üretim Yapma Eğilimlerini Artıran Yaklaşımların Belirlenmesi İzmir İli Örneği. Yuzuncu Yıl University Journal of Agricultural Sciences, 29(1), 82-87.
- Değer H. C., Özder U., Kınıklı F., Yercan M., 2020. Muğla İlinde Üreticilerin Domates Pazarlaması Üzerine Kooperatifleşme Eğilimlerinin Belirlenmesi. Tarım Ekonomisi Dergisi, 26(2), 121-129.
- Demir Y., 2019. Üreticilerin Toptancı Hallerine ve Hal Yasasına Bakış Açılıarı. Toprak Su Dergisi, 8(1), 1-10.
- Demirbük, M., 2013. Evaluation of the Rural Development Investment Support Program, Sivas Province Example. Gaziosmanpaşa University, Institute of Science and Technology Master's Thesis.
- Demirbük M., Ayyıldız B., 2021. Evaluation of the Factors Affecting Benefiting from the Grant Program in Rural Development Projects, Case Study of Sarıveliler, Karaman Province. Anadolu Tarım Bilimleri Dergisi, 36(1), 34-44.
- Doğan B., İkikat Tümer E., 2019. Çiftçilerin İyi Tarım Uygulamalarına Katılma İstekliliklerini Etkileyen Değişkenler: Kahramanmaraş İli Örneği. Yuzuncu Yıl University Journal of Agricultural Sciences, 29(4), 611-617.
- Doğan Öz, B., Saner G., 2020. Kiraz Üretimi Yapan İşletmelerin Makine ve Ekipman Alımlarının Desteklenmesi Programından (MEADP) Yararlanma Eğiliminin Belirlenmesi ve Devamlılığı: İzmir-Kemalpaşa İlçesi Örneği. Tekirdağ Ziraat Fakültesi Dergisi, 18(1), 1-9.
- Dönmez Özyakar H., Yılmaz H., 2021. Süt Sığırcılığı İşletmelerinde Ahır Gübresi Kullanımının ve Yönetiminin Ekonomik Analizi: Burdur İli Örneği. , 460 - 469.
- Erdal G, Erdal H, Ayyıldız B, Ayyıldız M, Çiçek A., 2019. Tokat İli Meyve-Sebze Üretiminde Pestisit Kullanımı ve Üreticilerin Bilinç Düzeyleri. Türk Tarım - Gıda Bilim ve Teknoloji Dergisi, 7(10), 1515 - 1521.
- Ergün A., Oruç E., 2023. The Relationship between Population Changes and Some Characteristics of the Village and Population Sustainability in Rural Areas: The Example of Tokat Province. Turkish Journal of Agriculture - Food Science and Technology, 11(11), 2161-2171.
- Everest B., Yavaş A., Tatar E., Acar İ., Çakar F., 2019. Çiftçilerin Kooperatifçilik Eğitimi Alma İsteğini Etkileyen Faktörler: Çanakkale İli Örneği. Anadolu Journal of Agricultural Sciences, 34(1), 40-46.
- Eydemir Ö., 2019. Kastamonu ilinde kivi yetiştiren işletmelerin sosyo-ekonomik durumu Yüksek Lisans Tezi, Tekirdağ Namık Kemal Üniversitesi, Tarım Ekonomisi Anabilim Dalı.
- Gaytancıoğlu O., Bayraktar E., Tavil S., 2000. Tarım Kesimindeki Sosyal Güvenlik Uygulamalarının Çiftçi Üzerindeki Etkileri: Tekirdağ Örneği. IV. Ulusal Tarım Ekonomisi Kongresi 6-8 Eylül 2000 Tekirdağ. 6-18 Eylül 2004. s.609-615, Tokat
- Gözener B., Yüksel M., 2019. Çiftçinin Tarıma Bakışı: Tokat İli Örneği. Gaziosmanpaşa Bilimsel Araştırma Dergisi, 8(3), 110-119.
- Gülse Bal H., Yüzbasoğlu R., Gürel E., 2019. Fındık Üreticilerinin Tarım Sigortası Yaptırmaya Yönelik Davranışları ve Bunu Etkileyen Faktörlerin Belirlenmesi: Giresun İli Bulancak İlçesi Örneği. Türk Tarım - Gıda Bilim ve Teknoloji Dergisi, 7(11), 2025 - 2029.
- Gültekin R., İkikat Tümer E., 2021. 6360 Sayılı Kanun İle Mahalleye Dönüştürülen Köylerde Tarımsal Üretim: Kahramanmaraş İli Örneği. Türk Tarım Ve Doğa Bilimleri Dergisi, 8(4), 974-982.
- Gündüz O., Aslan A., Ceyhan V., Bayramoğlu Z., 2020. Kuru Kayısı Tarımında Risk Yönetim Stratejisi Tercihlerini Etkileyen Faktörlerin Multivariate Probit Analizi. Türk Tarım - Gıda Bilim ve Teknoloji Dergisi, 8(11), 2482-2490.
- Gündüz O., Aslan A., Yıldırım Ç., 2023. Malatya İlinde Küçük Ölçekli Üretim Yapan Kayısı İşletmelerinin Sosyo-Ekonomik Özellikleri. Tarım Ekonomisi Araştırmaları Dergisi, 9(EKS 1), 40-50.



- Gündüz O., Akay M., 2003. Malatya İli Merkez İlçede Kayısı Yetiştiriciliği Yapan Tarım İşletmelerinin Ekonomik Analizi, Üretim ve Pazarlama Sorunları. Journal of Agricultural Faculty of Gaziosmanpaşa University (JAFAG), 2003(1).
- Gür O., 2019. Çiftçilerin Tarım Sigortası Yaptırma Kararlarını Etkileyen Faktörlerin Analizi: Mersin İli Mut İlçesi Kayısı Üreticileri Üzerine Bir Araştırma. Yüksek Lisans Tezi, Kırıkkale Üniversitesi, Sosyal Bilimler Enstitüsü, İktisat Anabilim Dalı, İktisat Bilim Dalı.
- Gürbüz İ.B., Kadağan Ö., 2019. Büyükşehir Yasasının Kırsala Etkileri; Bursa İli Örneği. Bursa Uludağ Üniv. Ziraat Fak. Derg., 33 (2), 209-226.
- Güven O., Yavuz F., 2020. Büyükbaş Hayvancılık Sektöründe Üretici Profili ve İşletme Yapısı: TRA2 Bölgesi örneği. Akademik Ziraat Dergisi, 9(1), 81-92.
- Irmak E., 2019. Tarım Kooperatiflerinde Yayım Yaklaşımları: Edirne İli Lalapaşa İlçesi Örneği Doktora Tezi, Tekirdağ Namık Kemal Üniversitesi, Fen Bilimleri Enstitüsü, Tarım Ekonomisi Anabilim Dalı.
- Işık V., Öztornacı B., 2019. Tarımsal Kooperatiflerde Çalışanların İşe Bağlılıkları Üzerine Bir Araştırma: Tire Süt Kooperatifi Örneği. Tarım Ekonomisi Dergisi, 25(2), 161-167.
- İkikat Tümer, E., Ağır H. B., Uslu, Z., 2019. Çiftçilerin Tarım Sigortası Yaptırma İstekliliği: Konya İli Ilgın İlçesi Örneği. Kahramanmaraş Sütçü İmam Üniversitesi Tarım ve Doğa Dergisi, 22(4), 571-576.
- İnan H., Boyraz N., 2000. Konya Çiftçisinin Tarım İlacı Kullanımının Genel Olarak Değerlendirilmesi. S.Ü. Ziraat Fakültesi Dergisi 16 (30): (2002)88-101.
- İnan S., Erdal H., Erdal G., 2022. Yem Bitkisi Üreten İşletmelerin Yapısal ve Ekonomik Analizi; Tokat İli, Almus İlçesi Örneği. Gaziosmanpaşa Bilimsel Araştırma Dergisi, 11(2), 135-148.
- İşçi B., Söyler K., Altındişli A., Boyacı M., 2019. Mevlana Üzüm Çeşidi Yetiştiren Üretici ve İşletmelerin Bazı Özellikleri ve Sorunları Üzerine Bir İnceleme. Journal of Agriculture Faculty of Ege University, 56(4), 487-495.
- Kaçıra Ö., Karlı B., 2004. Şanlıurfa İlinde Pamuğun Pazarlama Yapısı. Harran Tarım ve Gıda Bilimleri Dergisi. 8. 33-40.
- Kaplan K., Kaplan E., Bal H.S.G., 2019. Orman Köylülerine Yönelik Orköl Destekleri, Üretici Memnuniyeti, Desteklerin Kullanılabilirliği ve Sürdürülebilirliği (Tokat İli Almus İlçesi Örneği). 3. Uluslararası UNİDOKAP Karadeniz Sempozyumu, 21-23 Haziran 2019, Tokat.
- Kaptaner H., 2003. Sociological Evolution of the Köy-Kent Project in Turkey: The Case of Dorutay. Yüksek Lisans Tezi, Yüzüncü Yıl Üniversitesi Sosyal Bilimler Enstitüsü Sosyoloji Anabilim Dalı, Van.
- Karabaş S., 2004. Samsun İli Çarşamba İlçesinde Sebze Yetiştiriciliği Yapan Tarım İşletmelerinin Ekonomik Analizi ve Önemli Bazı Sebzelerin Maliyet ve Karlılıklarının Belirlenmesi. Yüksek Lisans Tezi, Tokat Gaziosmanpaşa Üniversitesi, Fen Bilimleri Enstitüsü, Tarım Ekonomisi Anabilim Dalı.
- Karakaya E., 2019. Arıcılık İşletmelerinde Mevcut Durum Temel Sorunlar ve Çözüm Önerileri Üzerine Bir Araştırma (Bingöl İli Örneği). U.Arı D.-U.Bee J. 2019;19(1):50-6.
- Karkacıer O., Gülse S., Oruç E., Göktolga G., 2000. Kırsal Sanayinin Kırsal Kesim Açısından Önemi ve Tokat İlinde Kırsal Sanayi Potansiyelinin İncelenmesi. IV. Ulusal Tarım Ekonomisi Kongresi 6-8 Eylül 2000 Tekirdağ. file:///C:/Users/Aysel-PC/Downloads/Karkac%C4%B1er,%20O.%202000.pdf
- Katipoğlu P., Armağan G., 2020. Tarımda Beşeri ve Sosyal Sermayenin Kırsal Kalkınmada Önemi. İzmir İktisat Dergisi, 35(1), 155-175.
- Kaya N., Çoker S., Kınıklı F., Yercan M., 2019. Çiftçilerin Kooperatifçiliğe Bakış Açılımları Üzerine Bir Araştırma: Ağrı Ve Eskişehir İlleri Örneği. Tarım Ekonomisi Dergisi, 25(2), 219-230.
- Kepenek Y.S., 2019. Türkiye’de Uygulanan Hayvancılık Destekleme Politikalarının Tokat İlindeki Hayvancılığın Gelişimine Etkileri. Yüksek Lisans Tezi, Tokat Gazi Osmanpaşa Üniversitesi Fen Bilimleri Enstitüsü, Tarım Ekonomisi Anabilim Dalı, Tokat, Türkiye.
- Kılıç O., Aydın Eryılmaz G., Çakır S., 2021. Zonguldak İlinde Meyve Üreticilerinin Kimyasal Gübre ve Tarım İlacı Kullanımına Yönelik Çevresel Duyarlılıkları. Anadolu Tarım Bilimleri Dergisi, 36(1), 113-121.

- Kılıçer E., 2019. Patates Üreticiliği Yapan Çiftçilerin Üretim Maliyetlerine İlişkin Algılarını Belirlemeye Yönelik Bir Araştırma: Niğde İli Örneği. *MANAS Sosyal Araştırmalar Dergisi*, 8(4), 3399-3415.
- Kızılaslan H., Kızılaslan N., 2005. Çevre Konularında Kırsal Halkın Bilinç Düzeyi ve Davranışları (Tokat İli Artova İlçesi Örneği). *ZKÜ Sosyal Bilimler Dergisi Cilt 1, Sayı 1*, 2005.
- Kızılaslan N., Kızılaslan H., Solmaz E., 2021. Kırsalda Özel Sigorta Uygulamaları Konusunda Bilgi ve Düşüncelerin Belirlenmesi (Tokat İli Örneği). *Gaziosmanpaşa Bilimsel Araştırma Dergisi*, 10(2), 118-130.
- Kızılaslan N., Almus S., 2000. Tokat - Zile - Güzelbeyli Beldesinde Uygulanan Arazi Topluşturmasında Benimsemeyi Etkileyen Sosyo - Ekonomik Faktörlerin Belirlenmesi Üzerine Bir Araştırma. *Journal of Agricultural Faculty of Gaziosmanpaşa University (JAFAG)*, 2000(1).
- Köksal H., 2019. Samsun İlinde Tarımsal Kredi Kullanımının Analizi. Yüksek Lisans Tezi, Ondokuz Mayıs Üniversitesi, Fen Bilimleri Enstitüsü, Tarım Ekonomisi Anabilim Dalı, Samsun, Türkiye.
- Kurt Y. A., Boz İ., 2021. Information Sources Used in Greenhouse Vegetable Growing: Samsun Province Çarşamba District Example. *KSÜ Agriculture and Nature Journal* 24 (4): 895-903.
- Mavioğlu M. Nazım., Çobanoğlu F., 2019. A Research on The Determination of Mechanism Levels of Farmers in Izmir City. *ADÜ ZİRAAT DERG*, 2019;16(1):19-26.
- Memiş H, Akgül K., 2021. Kırsal Kalkınma Bağlamında Türkiye’de İpek Böcekçiliği: Bursa İli Örneği. *Balıkesir Üniversitesi İktisadi ve İdari Bilimler Fakültesi Dergisi*, Aralık 2021, 2(2), 145-159.
- Odacıoğlu Ş. G., Çiçek A., 2000. Kentte Yaşayan Ailelerin Kırsal Kesimde Sahip Olduğu Varlıklar ve Bunları Değerlendirme Üzerine Bir Araştırma, Tokat ili Örneği. *Journal of Agricultural Faculty of Gaziosmanpaşa University (JAFAG)*, 2000(1).
- Oruç E., 2001. Tokat İlinde Bitkisel Üretimde Tarımsal Mücadele Uygulamaları ve Çiftçilerin İlaç Kullanımı Konusundaki Bilgi Düzeyleri İle Bilgi Kaynakları Üzerine Bir Araştırma. Doktora Tezi, Tokat Gaziosmanpaşa Üniversitesi, Fen Bilimleri Enstitüsü, Tarım Ekonomisi Anabilim Dalı.
- Öcal Kara, F., Binici, T., 2021. Üreticilerin Sulama Öncesi Bilgilerinin Tarımsal Yayım Açısından Değerlendirilmesi: Suruç Ovası Örneği. *Türk Tarım ve Doğa Bilimleri Dergisi*, 8(3), 772-783.
- Özbek H., 2019. Tarımsal Biyoçeşitliliğin Korunmasında Yerel Tohum Kullanımı ve Üretici Farkındalığı (Ankara İli Ayaş İlçesi Örneği). Yüksek Lisans Tezi, Tokat Gazi Osmanpaşa Üniversitesi, Fen Bilimleri Enstitüsü, Tarım Ekonomisi Anabilim Dalı, Tokat, Türkiye.
- Özdemir Y., Kınıklı F., Engindeniz S., 2021. Süt Sığırcılığı İşletmelerinin Yapısal Özellikleri ve Sorunları Üzerine Bir Araştırma: Balıkesir’in Gönen İlçesi Örneği. *Türk Tarım Ve Doğa Bilimleri Dergisi*, 8(4), 1001-1011.
- Özel R., Sağlam N., 2022. Türkiye’de Buğday Satış Zamanını Etkileyen Risk Faktörleri: Şanlıurfa İli Örneği. *Social Sciences Studies Journal (SSSJJournal)*.
- Özer B., Tümer İkikat E., 2021. Süt Sığırcılığı İşletmelerinin Yapısal Özellikleri. *Çukurova J. Agric. Food Sci.* 36(2): 187-200.
- Özer D., İkikat Tümer E., 2020. Limon Üreticilerinin Risk Karşısındaki Tutum ve Davranışlarını Etkileyen Faktörlerin Analizi: Mersin İli Erdemli İlçesi Örneği. *Türk Tarım Ve Doğa Bilimleri Dergisi*, 7(4), 988-996.
- Özkan B., Akçaöz H., Karadeniz Yavuz C. F., 2002. Antalya İli Turunçgil Üretiminde Tarımsal İlaç Kullanımının Ekonomik Analizi . V. Tarım Ekonomisi Kongresi (pp.57-62). Erzurum, Turkey.
- Öztürk F., Kılıç H., Karakaya E., 2023. Muş İli Buğday Üretiminin Mevcut Durum Analizi. *Türk Tarım ve Doğa Bilimleri Dergisi*, 10(1), 116-132.
- Sağlam F. Boz İ. 2023. Kırsalda Yaşayan Çiftçilerin Yaşam Memnuniyeti ve Gelecek Beklentisi: Çorum İli Kargı İlçesi Örneği. *MAS JAPS* 8(2): 403-411, 2023.
- Salalı E., Atış E., Günden C., 2019. Su Kaynaklarının Korunmasında Yerel Tohum Çeşitlerinin Rolü Üzerine Çiftçi Görüşleri. *Tarım Ekonomisi Dergisi*, 25(2), 133-139.
- Sarı Gedik D., 2019. Kırsal Kalkınmada Genç Çiftçi Projesi: Tekirdağ İli Örneği. Yüksek Lisans Tezi, Tekirdağ Namık Kemal Üniversitesi, Fen Bilimleri Enstitüsü.
- Satılmış A. S., Kul E., 2023. Amasya İli Manda İşletmelerinin Sosyo-Ekonomik ve Yapısal Özellikleri, Sorunları ve Çözüm Önerileri. *Akademik Ziraat Dergisi*, 12(2), 259-270.
- Sayın B., Bayav A., Beşen T., Karamürsel D., 2020. Üreticilerin Biyolojik ve Biyoteknik Mücadele Uygulamalarına Bakışı ve Çevre Duyarlılıklarının Belirlenmesi. *Kahramanmaraş Sütçü İmam Üniversitesi Tarım ve Doğa Dergisi*, 23(2), 453-466.



- Solmaz E. E., Özdemir H. Ö., 2021. Tarım İşletmelerinde Kadın Girişimciliği. *Sürdürülebilir Mühendislik Uygulamaları ve Teknolojik Gelişmeler Dergisi*, 4(1), 3-15.
- Sönmez S., Artukoğlu M., 2021. Kırsal Kesimde Tasarruf Eğilimini Etkileyen Faktörler Üzerine Bir Araştırma. *Adnan Menderes Üniversitesi Ziraat Fakültesi Dergisi*, 18(2), 189-195.
- Şahin A., Çakır C., Yıldırım İ., 2004. Van Yöresindeki Kırsal Alanlarda Nüfus ve Eğitime İlişkin Sorunlar ve Bazı Çözüm Önerileri. [file:///C:/Users/Aysel-PC/Downloads/%C5%9Eahin,%20A.%202004%20\(1\).pdf](file:///C:/Users/Aysel-PC/Downloads/%C5%9Eahin,%20A.%202004%20(1).pdf)
- Şenol E., 2019. Büyükşehir Statüsündeki İllerde Kırsal Nüfusun Tespiti: Ordu İli Örneği. *Türk Coğrafya Dergisi* (72), 53-63.
- Şenyüz E., Bahşi N., 2023. Türkiye’de Amasya İlindeki Çiftçilerin Tarımsal Yayım ve Danışmanlık Hizmetlerinden Yararlanma Düzeyleri ve Bilgi Kaynakları. *Mustafa Kemal Üniversitesi Tarım Bilimleri Dergisi*, 28 (2), 477-488.
- Şimşek Y. B., Armağan G., 2020. Tarımsal Yayım ve Danışmanlık Hizmetlerinde Algılanan Hizmet Kalitesi: Aydın İlinde Bir Uygulama. *Organizasyon ve Yönetim Bilimleri Dergisi*, 12(2), 150-169.
- Tanrıvermiş H., 2000. Orta Sakarya Havzası’nda Domates Üretiminde Tarımsal İlaç Kullanımının Ekonomik Analizi. TEAE, Yayın No : 42, Ankara.
- Tapkı N., Öztornacı B., Kantar Davran M., 2021. Tarımsal Çevre Kirliliği Açısından Üreticilerin Bilinç Düzeyi: Doğu Akdeniz Bölgesi Örneği. *ISPEC Journal of Agricultural Sciences*, vol.5, no.3, 641-651.
- Taşçı R., Tarhan S., Söylemez E., Özercan B., 2023. Üreticilerin Kırsaldan Göç Etme Düşünceleri ve Buğday Üretimi Üzerine Olası Etkisi. *Türk Tarım ve Doğa Bilimleri Dergisi*, 10(4), 865-875.
- Tolunay A., Akboğa İ., Özmiş M., 2023. Türkiye’de Market Zincirlerinin Özellikle Orman Köylülerinin Satın Alma ve Tüketim Anlayışı Üzerine Etkileri: Yozgat Kırsalında Orman Köylüleri Vaka Çalışması. *JENAS Journal of Environmental and Natural Studies*, 5(3), 202-220.
- Topal E., Adanacıoğlu H., Karaman S., Kösoğlu M., 2020. Arıcılık İşletmelerinin Bilgi Transfer Kaynakları: İzmir İli Örneği. *Avrasya Sosyal ve Ekonomi Araştırmaları Dergisi*, 7(1), 150-161.
- Topbaş N. T., 2019. Yerel ve Kırsal Kalkınmada Coğrafi İşaret: Zile Pekmezi Araştırması. Yüksek Lisans Tezi, Tokat Gaziosmanpaşa Üniversitesi, Fen Bilimleri Enstitüsü, Tarım Ekonomisi Anabilim Dalı, Tokat, Türkiye.
- Torgut E., Annayev S., Örmeci Kart, M. Ç., Türkekul B., 2019. Süt Sığırcılığı Yapan İşletmelerin Genel Özelliklerinin Belirlenmesi: İzmir İli Ödemiş ve Tire İlçeleri Örneği. *Tarım Ekonomisi Dergisi*, 25(1), 87-95.
- Torun E., Taluğ C., 2005. Çay Budama Projesi Kapsamında Üreticilerin Kullandıkları Bilgi Kaynakları. *Tarım Ekonomisi Dergisi*, 11(1 ve 2), 41-49.
- Turan B., Demircan V., 2021. Organik Ürün Tüketiminin Mevcut Durumu ve Tüketimi Etkileyen Faktörler: Isparta İli Örneği. *Ziraat Fakültesi Dergisi*, 16(2), 154-168.
- Uzmay A., Durmaz S., Örümlü AE., 2001. Mordoğan’da Nergis (*Narcissus poeticus*) Yetiştiriciliği Sorunları Üzerine Bir Araştırma. *Ege Üniv. Ziraat Fak. Derg.*, 2001, 38(1):39 -46 ISSN 1018-8851.
- Uzun T., 2021. Kocaeli İlinde Fındık Üretimi Yapan Çiftçiler ile Fındıkta Kullanılan Pestisitler Hakkında Bilinç Düzeyinin Araştırılması. Yüksek Lisans Tezi, Bursa Uludağ Üniversitesi, Fen Bilimleri Enstitüsü, Bitki Koruma Anabilim Dalı.
- Ünal S. A., İkkat Tümer E., 2021. Çiftçilerin Tarımsal Üretim Yapma Amaçlarının Sıralanması Üzerine Bir Araştırma: Kahramanmaraş İli Örneği. *Yuzuncu Yıl University Journal of Agricultural Sciences*, 31(1), 162-169.
- Veziroğlu P., Emeksiz F., 2020. Çukurova Bölgesinde Turunçgil Üreticilerinin Üretim Süreçlerindeki Kararlarının Ekonometrik Analizi. *Tarım Ekonomisi Dergisi*, 26(2), 89-99.
- Yıldız A.K., Ayyıldız M., Ayyıldız B., Arslan S., 2022. Technical and Socio-Economic Beekeeping Enterprises of Yozgat Province Investigation of Status. *Turkish Journal of Agriculture - Food Science and Technology*, 10(5): 846-852, 2022.
- Yılmaz E., Özdemir G., Oraman Y., Unakıtan G., Konyalı S., 2019. Tarımsal Üretimde Kadınların Karar Alma Süreçlerine Katılımı ve Kooperatiflerden Beklentileri. *Journal of Tekirdag Agricultural Faculty (Jotaf)*, Ocak/January 2019, 16(1).



- Yılmaz E., Turğut U., Tosun D., Gümüş S., 2020. İzmir İlindeki Çiftçilerin Kırsal Nüfusun Yaşlanma Eğilimi ve Tarımsal Faaliyetlerin Devamlılığına İlişkin Görüşleri. *Tarım Ekonomisi Dergisi*, 26(2), 109-119.
- Yiğit B., 2022. Kırsal Alanda Kadın Emegi ve Kadının Yeri: Şanlıurfa İli Örneği. Yüksek Lisans Tezi, Harran Üniversitesi, Fen Bilimleri Enstitüsü, Tarım Ekonomisi Anabilim Dalı, Şanlıurfa.
- Yüzbaşıoğlu R., 2019. Tokat İli Merkez İlçe Kırsalında Üreticilerin Toprak Analizi Yaptırma Eğilimleri. *Bahri Dağdaş Bitkisel Araştırma Dergisi*, 8(1), 163-169.
- Yüzbaşıoğlu R., Kızılaslan H., 2020. Tokat İli Turhal İlçesi Hayvansal Destekleme Kullanan Üretici Memnuniyetini Etkileyen Faktörlerin Belirlenmesi. *Gaziosmanpaşa Bilimsel Araştırma Dergisi*, 9(1), 1-12.



## Evaluation of the Education Levels of Agricultural Operators in Türkiye and The Evolution of Education Level Over Time

Kürşat YALINALP<sup>1\*</sup>, Aysel ERGÜN<sup>2</sup>, Esen ORUÇ<sup>3</sup>

<sup>1</sup>School of Natural and Applied Science, Tokat Gaziosmanpaşa University, 60250 Tokat, Türkiye

<sup>2</sup>Department of Agricultural Economics, Agricultural Faculty, Tokat Gaziosmanpaşa University, 60250 Tokat, Türkiye

<sup>3</sup>Department of Agricultural Economics, Agricultural Faculty, Tokat Gaziosmanpaşa University, 60250 Tokat, Türkiye

Corresponding author e-mail: aysel.ergun3018@gop.edu.tr

### Abstract

*Compared to urban areas, rural areas have limited advantages and many disadvantages. Educational opportunities can be considered as the most important disadvantage of rural areas with its large-scale and deep impact. Education has been addressed in many micro-level studies conducted in rural areas in Türkiye. Following the migration movement from rural to urban areas and the changes in the field of education, it was thought that it would be useful to reveal how the educational outlook of agricultural producers has changed based on the data of field studies and this study was decided. The aim of this study is to reveal the current situation regarding the educational level of agricultural operators in Türkiye and the twenty-year change between 2000-2024, based on the results of field studies. In the study, it was attempted to reach conclusions on the general level of education in Türkiye and the change in the level of education over time through the compilation and meta-analysis of data on the level of education of agricultural producers in micro-level studies conducted in rural areas in two different periods, 2000-2005 and 2019-2024. The main material of this study consists of the results of micro-level studies conducted in different rural areas of Türkiye on the level of education of farmers. In this study, a comprehensive literature review was conducted and data on farmer education from over a hundred studies were gathered. Descriptive statistics, t and ANOVA tests were used to make periodic and regional comparisons over the obtained data set. According to the results, there is a change between the two periods and it appears to be statistically significant.*

**Keywords:** Rural areas, Farmers' Education Level, Education in Rural Area, t Test, Anova Test

### INTRODUCTION

Regardless of the level of development, agriculture and rural areas have a special place in all country economies. For a long time, in the world and in parallel in Türkiye, the growth of industry was accepted as the basic element of development, and accordingly, agriculture and rural areas were left in the background (Açıkgöz, 2007). Towards the 1980s, it was understood that rural areas and their most important component, agriculture, were of key importance for all countries, including industrialized ones, and that their neglect made integral development difficult. With this realization, rural and agricultural development has become one of the issues the world focuses on (Doğan, 2015).

Rural development efforts, which have been irregular and piecemeal since the founding years of the Republic of Türkiye, have been tried to be carried out with more regular projects with the beginning of planned periods. In this process, efforts were made to increase the level of welfare in rural areas through practices such as Village-Town projects, Village Institutes and State Production Farms. After the period when the level of welfare was primarily associated with increased production, it was understood that only increasing production would not be sufficient to achieve rural development. Afterwards,

development goals such as increasing income, improving living standards, and facilitating access to various opportunities were put at the center of development efforts from time to time. However, at the center of development today is the development of human capital and its key tool, education. It is now accepted that the development of a region is closely related to the development of the knowledge, skills and world perception capacity of the population in that region (Uçkaç, 2009).

Compared to cities, rural areas seem to have limited advantages but many disadvantages. Educational opportunities can be considered the most important disadvantage of rural areas, with their large-scale and deep impact. Due to this disadvantage, the education level of the rural population always lags behind that of the urban population. It is possible to reveal the deep difference in the education level of rural and urban populations through statistics or field-based research results. Disadvantage in education brings with it other disadvantages for the region or country experiencing it.

Education plays an important role in the economic development of countries, not only because of the special benefits it provides to individuals, but also because of the externalities it creates for society. As the education level of individuals increases, the qualified workforce problem is overcome and scientific and technological innovations accelerate. As a result of the increase in labor productivity, the national income level increases rapidly and the income created becomes more equitably shared. In societies where education levels increase, the rate of return on investments in education is higher than that of physical capital investments, as the administration becomes more democratic, it becomes easier to ensure economic and political stability and crime rates decrease (Öztürk, 2005).

Scientific research has revealed that there are linear relationships between the level of education and economic growth, political and social development, which are the elements of development. The contribution of human resources especially to social improvement and therefore economic development is quite great. According to educational economists the fundamental point of economic development is education. The purpose of education is to meet all kinds of demands and needs of both the country and the people (Çakmak, 2008).

Education is naturally a field of research that is always worth studying. The education level of the people engaged in agriculture in rural areas is the subject of various discussions and is addressed from different dimensions in rural and agricultural studies. In the studies to be carried out on the education factor, which is a part of the social character, and in the search for a solution, first the question "What is the current situation?" The answer to the question should be clearly stated. Statistics on the education level of rural areas are presented by national and international institutions. On the other hand, micro-level studies focus on the details of regional dynamics and specific population segments of the general situation revealed by statistics. Education has been discussed in many micro-level studies conducted in rural areas in Turkey. These studies have revealed various results regarding the level of education for groups such as rural population, farmers and women. Although these results, encountered in different times and environments, support creating a profile for those interested in the subject, a systematic evaluation of the results would be beneficial for a more accurate situation analysis. In addition, it was thought that dimensioning this designed evaluation with the time factor would increase the benefit of the study. Following the migration movement from rural areas to cities and changes in the field of education, it was thought that it would be useful to reveal how the educational landscape changed, specifically for agricultural producers, based on micro-level studies data, and this study was decided.

The aim of this study is to reveal the current situation regarding the education level of agricultural operators in Türkiye and the twenty-year change between 2000-2024, based on the results of field studies. In the study, through the compilation and meta-analysis of data on the education level of agricultural operators in micro-based studies carried out in rural areas in two separate periods, 2000-2005 and 2019-2024, it was tried to reach conclusions about Türkiye in general and the change in the education level over time.



## MATERIAL AND METHODS

The main material of this study consists of the farmer education level findings revealed in micro-level studies conducted in different rural regions of Türkiye. The study is a Meta Analysis study as a method. Meta-analysis is a method of combining the results of multiple, independent studies on a specific subject and performing statistical analysis of the obtained research findings. In order to reveal the change in the study, it was decided to examine two different periods, and the aim was to keep the interval between the two periods as wide as possible. Since access to studies before 2000 was quite limited, the year 2000 was accepted as the lower limit for the first period discussed. For the second period, 2024 is considered as the upper limit. Considering that the number of studies for a single year (2023 or 2024) would be insufficient for evaluation, the year ranges 2000-2005 for the beginning and 2019-2024 for the second period were determined as the time scope of the study.

In the study, first of all, a comprehensive literature review was conducted and data on farmer education was brought together from more than seventy studies. The results of the research obtained regarding the education level of the farmers were transferred to the appropriate program platform in a computerized environment within a certain systematic framework. The findings given as percentages of education levels and average years of education were brought together separately and some studies had to be eliminated in order to create a compatible data set. After creating the data set, the percentage rates of education levels were evaluated through descriptive statistics. In addition, a score was given for each level of education (illiterate: 1, bachelor's degree and above: 6) multiplied by the education percentage rates and a score level was reached for each study by summing the score for each education level. Based on the scores obtained, periodic and regional comparisons were made with descriptive statistics, t and ANOVA tests. Graphs and tables were used to visualize the difference between the two periods.

The micro level studies examined within the scope of the study are given in Table 1 and Table 2

**Table 1.** Resources examined for the period 2000-2005

Nu m ber	Resources	Nu m ber	Resources
1	Acar İ., Yıldırım İ., 2000.	12	İnan H., Boyraz N., 2000.
2	Adıgüzel F., Akay M., 2005.	13	Karabaş S., 2004.
3	Akçay Y., Çiçek A., Uzunöz M., Sayılı M., 2000.	14	Karkacier O., Gülse S., Oruç E., Göktolga, G., 2000.
4	Ceyhan V., Cinemre H.A., Bozoğlu B., Demiryürek K., Kılıç O., 2004.	15	Kızılaslan H., Kızılaslan N., 2005.
5	Çelik M., 2002.	16	Kıracı M. A., 2001.
6	Dağdemir V., 2004.	17	Oruç E., 2001.
7	Eltez S., Eltez R. Z., 2005.	18	Özer M., 2005.
8	Gaytancıoğlu O., Bayraktar E., Tavil S., 2000.	19	Şahin A., Çakır C., Yıldırım İ., 2004.
9	Gökçe O., 2004.	20	Tanrıvermiş H., 2000.
10	Gökdoğan O., Bayhan A.K., 2004.	21	Torun E., Taluğ C., 2005.
11	Gündüz O., Akay M., 2003.	22	Uzmay A., Durmaz S., Örümlü A.E., 2001.

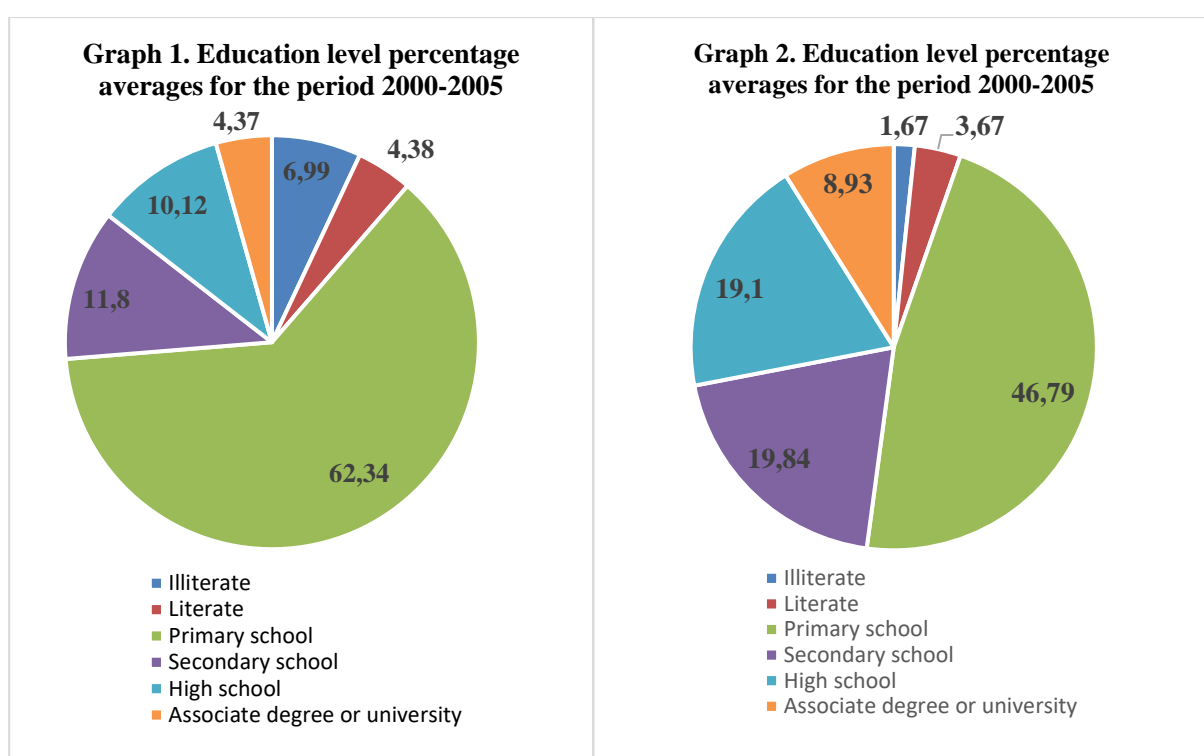
**V. International Applied Statistics Congress (UYİK - 2024)**  
**Istanbul / Turkey, May 21-23, 2024**

**Table 2.** Resources examined for the period 2019-2024

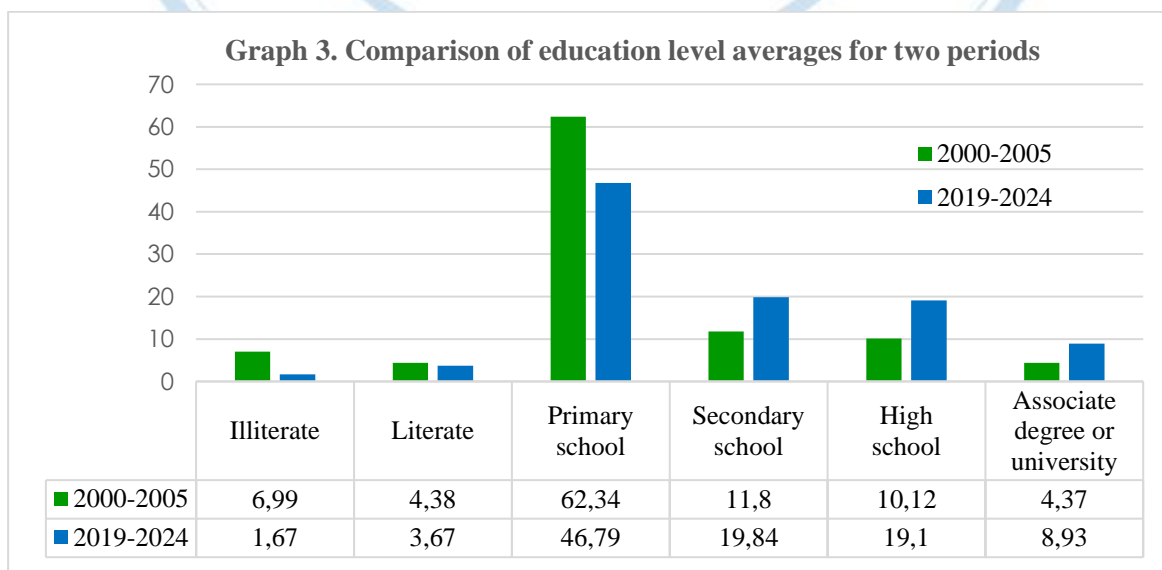
<b>Num ber</b>	<b>Resources</b>	<b>Num ber</b>	<b>Resources</b>
1	Abdikoğlu D.İ., Unakıtan G., 2019.	26	Erdal G., Erdal H., Ayyıldız B., Ayyıldız M., Çiçek A., 2019.
2	Akçalı A., 2022.	27	Erdal G., Erdal H., Çiçek A., 2020.
3	Akkurt Özolgun H., 2020.	28	Erdil M., Tiryaki O., 2020.
4	Aktürk D., Aydın B., 2019.	29	Eryılmaz Aydın G., Kılıç O., 2021.
5	Alemdar Ö., Akkurt M., Ataseven Y., 2019.	30	Gönültaş H., 2020.
6	Altıntaş G., Altıntaş A., Bektaş H., Çakmak E., Kızılaslan H., Birol D., 2019.	31	Gözener B., Yıldırım S., 2019.
7	Altın Ö., Demiryürek K., 2021.	32	Gülse Bal H.S., Yüzbaşıoğlu R., Kaplan E., 2019.
8	Aydemir A., 2019.	33	Gültekin R., İkikat Tümer E., 2021.
9	Aydın Y. K., 2020.	34	Gündüz O., Aslan A., Ceyhan V., Bayramoğlu Z., 2020.
10	Aydoğan M., Uysal O., Candemir S., Terzi Y.E., Raşçı R., Beşen T., Öztürk F.P., Emre M., Eralp Ö., Gündüz O., Ceyhan V., 2020.	35	İkikat Tümer E., Ağır H. B., Uslu Z., 2019.
11	Aydoğdu M.H., Aydoğdu İ., Cevheri C., Sevinç M.R., Küçük N., 2020.	36	İnan S., Erdal H., Erdal G., 2022.
12	Aydoğdu M.H., Altun M., 2019.	37	Kan M., Kan A., Sözen Ö., Karadavut U., Yağmur M., 2019.
13	Aydoğdu M.H., Yıldızoğulları N., 2021.	38	Kaplan K., Kaplan E., Gülse Bal H.S., 2019.
14	Bakır G., Kibar M., 2020.	39	Karabak S., Taşçı R., Ceyhan V., Özbek K., Yüce Arslan H., 2019.
15	Bayraktar A., Boz İ., 2019.	40	Kızılaslan N., Somak E., 2019.
16	Bedel N. E., 2019.	41	Köksal H., 2019.
17	Belen M., Yanar D., Erdal G., 2020.	42	Kurt Y. A., Boz İ., 2021.
18	Beşen T., Sayın B., Karamürsel D., Çelikyurt M.A., 2021.	43	Öz K., Kızılaslan N., 2019.
19	Birsin S., 2021.	44	Salalı E., Atış E., Günden C., 2019.
20	Çiçekgil Z., Ataseven Y., 2021.	45	Topal E., Adanacioğlu H., Karaman S., Kösoğlu M., Bayar F., 2019.
21	Çiftçi K., Miran B., Kanberoğlu Z., 2019.	46	Uslu T., 2019.
22	Çukur T., Kızılaslan N., Kızılaslan H., 2019.	47	Veziroğlu P., Emeksiz F., 2020.
23	Demirbük M., Ayyıldız B., 2020.	48	Yıldız Ö., 2019.
24	Doğan Öz, B., Saner G., 2020.	49	Yılmaz E., Turgut U., Tosun D., Gümüş S., 2020.
25	Doğan B., İkikat Tümer E. 2019.	50	Yüzbaşıoğlu R., Kızılaslan H., 2020.

## RESULTS

In the study, research revealing the education level of producers between 2000-2005 and 2019-2024 was brought together. In order to reveal whether there was a change in the education levels of producers in these two periods, proportional distributions were made, averages were calculated, and minimum and maximum education levels were determined. The years 2000-2005 are expressed as the first period, and the years 2019-2024 are expressed as the second period.

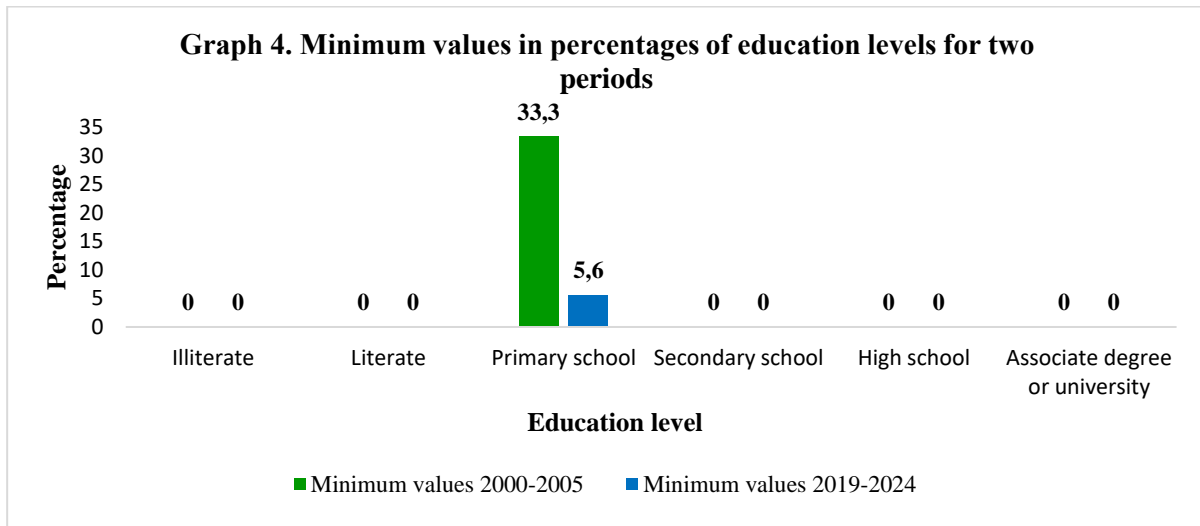


Graphs 1 and 2 reflect the distribution of proportional averages of farmers first and second period education levels calculated based on field research findings. The prominent change in the distribution of farmers' education levels between the two periods is the proportional difference in primary school graduates. It is seen that the primary school education level, which was 62.3% in the first period, decreased to 46.8% in the second period. This situation can be associated with the shift in primary school rates to the secondary education level with the increase of compulsory education to eight years as of the 1997-1998 academic year and to 12 years as of 2012-2013. In the second period, the rate of producers with primary, secondary and high school graduates increased approximately 1.5 times, and the rate of associate degree and above graduates doubled. The rate of illiterates decreased from 7% to 1.7%, while literacy remained almost the same. Thus, the education level of farmers in rural areas has increased to some extent, secondary and high school education. Although the rate of associate degree or university graduates has approximately doubled, it is seen that this rate still has a small share in the whole.



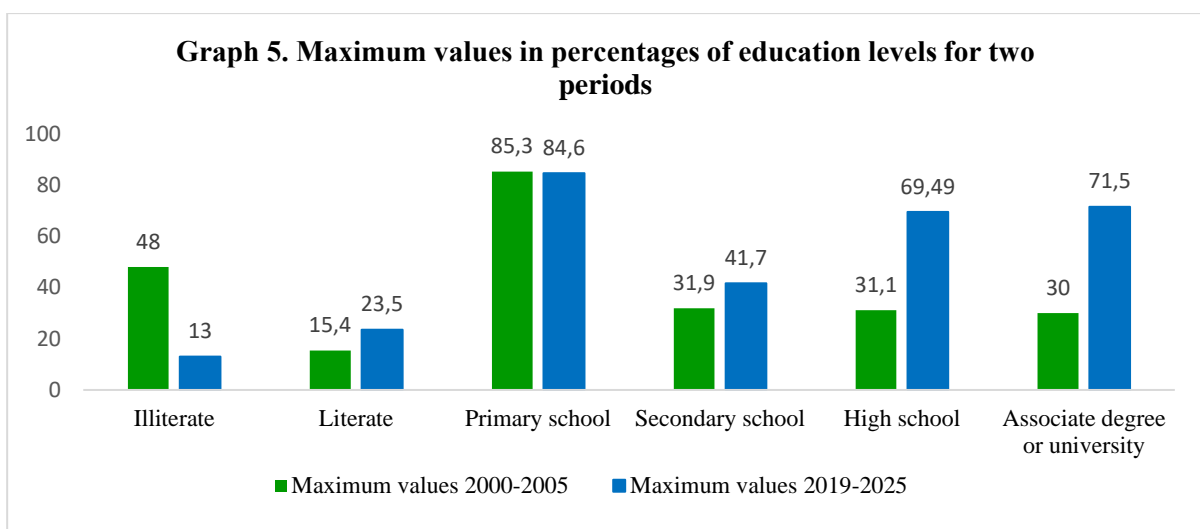


It is given to visualize the comparison reflected in Graph 3, Graph 1 and Graph 2 as a bar graph and with the rates for the periods side by side. As can be seen in this graph, the averages in low education levels such as primary school, literate and illiterate in the first period are higher than in the second period. It has been determined that the second period averages are high at higher education levels such as primary-secondary school, high school, associate degree and above. In other words, in the studies of the first period, education levels are concentrated on primary school and below education levels, and in studies in the second period, they are concentrated on secondary school, high school, associate degree and above education levels.



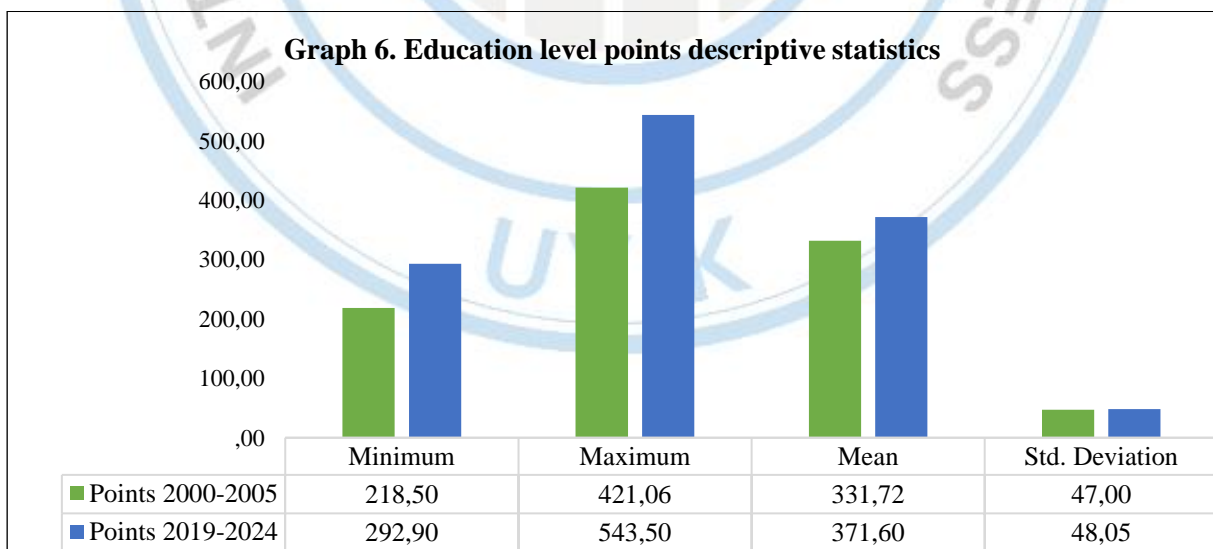
Within the scope of the study, the minimum and maximum values of the education levels of the two periods were compared. This comparison aims to make an between periods evaluation by interpreting the lowest and highest percentage rate values among the researches included the study for education levels. Among the field studies examined, there is no research that does not include the primary school level. Education at the primary school level reflects a characteristic situation for rural areas in Türkiye. In field studies conducted in rural areas, the highest rate is generally primary school among education levels. Among the studies examined, the lowest primary school graduation rate is 33% in the first period and 9% in the second period. These findings can be interpreted as the first period primary school graduation rate being a more common education level among farmers.

The fact that the minimum values for other education levels are zero in Graph 4 reveals that there are studies in which these education levels were not included at all in both periods and therefore there are rural regions where there are no farmers at this education level. Looking at the minimum education level averages, it can be seen that there are research results where high school and higher education levels are still zero in the period after 2019.



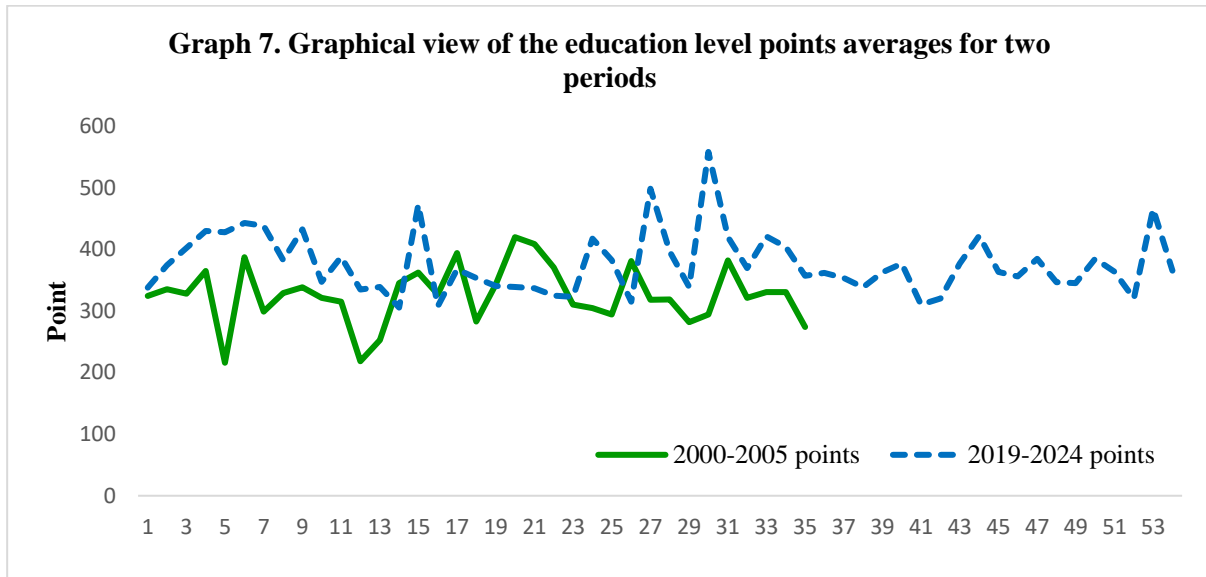
The maximum values show that there are still regions where the primary school education level is above 80% in the second period. The difference between the maximum values of illiteracy is also striking. While the rate of illiteracy was 48 percent in the first period, this rate dropped to 13 percent in the second period. Among the studies examined, the highest illiteracy rate is 13%. Although the decrease in the rate of illiteracy is pleasing, it is thought-provoking that the rate of illiteracy is still 13% in the 2019-2024 period. There was an increase of over 100 percent between the two periods at the level of education at high school and above. It is understood that in the second period, the education level of farmers in some regions reached 70 percent in the high school and above group (Graph 5).

While creating the research findings up to this part of the study, the averages of the percentage distributions were analyzed. After this section, determinations were made based on the Education Level Point created for each study. With the points created, a point level was determined for each study (for the region where the study was conducted). Scoring enables a more accurate evaluation by creating a single-column array. When the descriptive statistics of education level points are examined, it is seen that the 2nd period is higher than the 1st period in minimum and maximum values.



Although the average values appear to be higher in the second period than in the first period, there is no significant difference. A more significant difference between the averages could have been expected in the approximately 15 years between the two periods. However, it appears that this difference does not

occur. When the standard deviation values are examined, it has been determined that there are no major differences between the studies within the two periods.



When Graph 7 is examined, it is seen that the maximum values of the first period education level points and the minimum values of the second period education level points are at the same levels. In other words, the education level in the second period increased towards the maximum level of the first period.

In the results of the difference test in periods of averages between the two periods regarding the education point, it is concluded that the averages of the values of the examined periods show a statistically significant difference since the significant value based on the t value is less than 0.05. This reveals that the education level of agricultural producers in Türkiye varies at a level that can be considered statistically significant from the beginning of the 2000s to the 2020s.

**Table 3.** Group statistics of education point averages

	Periods	N	Mean	Std Deviation	Std. Error Mean
Education points mean	Period 1	35	326,6503	47,10472	7,96215
	Period 2	54	377,0083	51,21492	6,96947

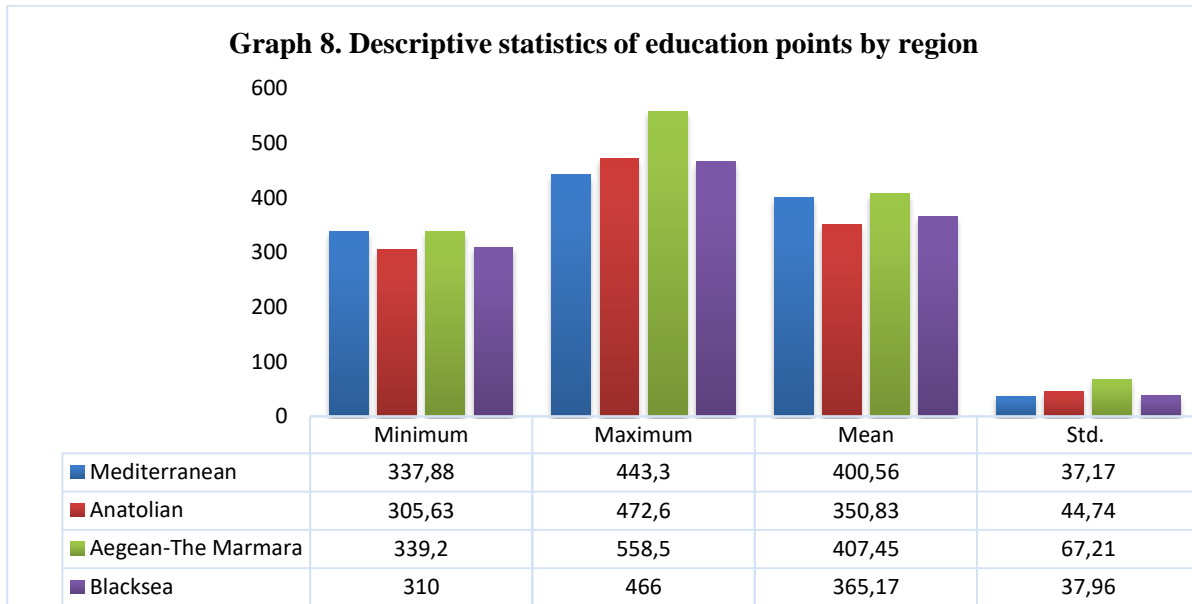
**Table 4.** t test on difference in education point mean according to periods (2000-2005 and 2019-2025)

		Levene's Test for Equality of Variance		t-test Equality of Means						
		F	Sig.	t	df	Sig (2-tailed)	Mean Difference	St. Error Difference	95% Confidence Interval of the Difference	
									Lower	Upper
Education points mean values	Equal variance assumed	,485	,488	-4,674	87	,000	-50,35805	10,77398	-71,772	-28,94
	Equal variance not assumed			-4,759	77,046	,000	-50,35805	10,58156	-71,428	-29,29

In the study, it was analyzed whether there was a difference in periods of education level for different regions of Türkiye. While descriptive statistics of education points by region were examined, evaluations were made based on the points given to regions and research. Only the second period was considered in the interregional evaluation. According to the evaluation, when the average education



level point of the region is examined, it has been determined that the Aegean-Marmara region is in the highest place, the Mediterranean region is in the second place, the Black Sea region is in the third place and the Anatolia region is in the fourth place. When the standard deviation values are examined, it can be seen that the differences between the studies are greater in the Aegean-Marmara region. It is understood from the studies examined that this situation arises from the differences between the coastal and inland studies. Standard deviation values reveal that research findings within regions approximate each other.



According to the minimum values between regions according to the education level point, the Aegean-Marmara region comes first, the Mediterranean region comes second, the Black Sea region comes third and the Anatolia region comes last. Accordingly, the lowest education point level belongs to the Anatolia region. As for the maximum values, unlike other regional evaluations, it is seen that the maximum value of the Mediterranean region is below the maximum values of the Black Sea and Anatolia regions. The highest point level belongs to the Aegean-Marmara Region. It can be stated that the Aegean-Marmara region stands out positively in periods of the education level of farmers, while Anatolia lags behind compared to other regions.

**Table 5.** Test of homogeneity of variances

Levrence Statistics	df1	df2	Sig.
1,304	3	50	,283

**Table 6.** ANOVA test on difference on education points mean values according to regions

	Sum of Squares	df	Mean Square	F	Sig.
Between Groups	28956,368	3	9652,123	4,385	0,008
Within Groups	110060,940	50	2201,219		
Total	139017,308	53			

Whether there is a statistically significant difference between regions in terms of the education level of farmers was analyzed by ANOVA test. Table 5 shows the results of the homogeneity test of education level average scores by region. Table 6 reflects the ANOVA test results. According to the analysis, education point vary significantly by region.

**Table 7.** Tukey test on difference on education points average values according to regions

*Dependent Variable pointrgn*

*Tukey HSD*

Regions	Regions	Mean Difference	Std. Error	Sig.	%95 Confidence Interval	
					Lower Bound	Upper Bound
Mediterranean	<b>Anatolian</b>	49,73200*	18,62414	<b>,049</b>	,2367	99,2273
	Agean-The	-6,88818	20,00554	,986	-60,0546	46,2783
	Marmara	35,38706	18,15473	,221	-12,8607	83,6348
	Blacksea					
Anatolian	<b>Mediterranean</b>	-49,73200*	18,62414	<b>,049</b>	-99,2273	-,2367
	Agean-The	-56,62028*	18,62414	<b>,019</b>	-106,1155	-7,1249
	Marmara	-14,34494	16,62021	,824	-58,5146	29,8247
	Blacksea					
Agean-The Marmara	Mediterranean	6,88818	20,00554	,986	-46,2783	60,0546
	<b>Anatolian</b>	56,62018*	18,62414	<b>,019</b>	7,1249	106,1155
	Blacksea	42,27524	18,15473	,105	-5,9725	90,5230
Blacksea	Mediterranean	-35,38706	18,15473	,221	-83,6348	12,8607
	Anatolian	14,34494	16,62021	,824	-29,8247	58,5146
	Ege-Marmara	-42,27524	18,15473	,105	-90,5230	5,9725

\*The mean difference is significant at the 0,05 level

The results of the Tukey analysis, which was conducted to determine the direction of the inter-regional differences in farmer education level average point, are shown in Table 7. According to the results, the average difference between the Mediterranean and Aegean-Marmara regions and the Anatolian region is statistically significant (Significant value at 0.05 level). The region with the highest education level of producers is the Aegean-Marmara Region. The regions with the lowest education level are Central Anatolia, Eastern Anatolia and Southeastern Anatolia, which are included under the term Anatolia.

## DISCUSSION AND CONCLUSION

The aim of this study was to reveal both the current situation of education in rural areas and its change between the periods of 2000-2005 and 2019-2024, using field research findings. According to the results, there is a change between the two periods and it appears to be statistically significant. It is thought that this change is related to the increasing social tendency to participate in formal education, as well as the extension of the duration of compulsory education, first to eight years and then to 12 years. Field research and other studies emphasize that the level of education in rural areas is still low. It is clear that there is a situation against rural areas in terms of education level and access to educational opportunities in the urban-rural distinction. Although there is talk of a positive change in the education level of farmers, it is possible to talk about the existence of problems that require solutions in the field of education in rural area.

Within the scope of the study, the differences between regions in terms of the education level of farmers were discussed. It was determined that the difference in farmer education level between regions was statistically significant. Through interregional difference analysis, it was determined that farmers in the eastern regions had a lower education level than other regions and the difference was statistically significant. It is thought that policies and studies should be carried out on farmer education in the east. As of the 2019-2024 period, it is observed that, on average, approximately 2% of farmers in Türkiye are still illiterate. This rate is even higher for some regions. It can be predicted that this rate consists of older farmers and that it will decrease or even disappear over time. However, extension and training solutions

can be considered for the agricultural production and management of the producers within this ratio which continues to exist for today.

Although general opinion and research indicate that there is a statistically significant change in education, a more significant increase in education could be expected after a significant period of time such as 20 years. It may be suggested that studies that will reveal the development in education continue to be carried out in a longer and more expanded manner.

## References

- Abdikoğlu D.İ., Unakıtan G., 2019. Determining Important Factors on Fish Consumption With Conjoint Analysis in Tekirdağ, Turkey. *FOODBALT 2019*. DOI:10.22616/FoodBalt.2019.003.
- Acar İ., Yıldırım İ., 2000. Mandıra İşleten Dönerdere Tarımsal Kalkınma Kooperatifine Ortak İşletmelerin Ekonomik Analizi. *Yüzüncü Yıl Üniversitesi, Ziraat Fakültesi, Tarım Bilimleri Dergisi (J.Agric. Sci.)*, 2000, 10(1):61-70.
- Açıkgöz Ş., 2007. Türkiye'de Uzun Dönem Büyüme Eğilimleri ve Politika Uygulamalarının Dönemsel Etkileri. *Gazi Üniversitesi İktisadi ve İdari Bilimler Fakültesi Dergisi* 9/1 (2007). 29-57.
- Adıgüzel F., Akay M., 2005. Tokat İlinde Gökkuşluğu Alabalık İşletmelerinin Ekonomik Analizi. *GOÜ. Ziraat Fakültesi Dergisi*, 2005, 22 (2), 31-40.
- Akçalı A., 2022. Çiftçilerin Ziraat Odasının Verdiği Danışmanlık Hizmetlerinden Memnuniyet Düzeyi: Samsun İli Terme İlçesi Örneği. *ISPEC Journal of Agr. Sciences* 6(2): 211-222, 2022 Copyright © ISPEC.
- Akçay Y., Çiçek A., Uzunöz M., Sayılı M., 2000. Tokat İlinde Sözleşmeli Domates Yetiştiriciliğinin Karşılaştırmalı Ekonomik Analizi. IV. Ulusal Tarım Ekonomisi Kongresi 6-8 Eylül 2000 Tekirdağ.
- Akkurt Özgün H., 2020. Tarım İşletmelerinde Muhasebe Kayıtları Tutulmasının Türkiye Tarımı ve Ekonomisi Açısından Değerlendirilmesi: Tekirdağ İli Örneği.
- Aktürk D., Aydın B., 2019. Structural Characteristics of Beekeeping Enterprises and Beekeeping Activities in Çanakkale Province. *Turkish Journal of Agriculture – Food Science and Technology*, 7(10), 1618–1628.
- Aktürk D., Savran F., Hakyemez H., Daş G., Savaş T., 2005. Gökçeada'da Ekstansif Koşullarda Hayvancılık Yapan İşletmelerin Sosyo-Ekonomik Açından İncelenmesi. *Tarım Bilimleri Dergisi* 2005, 11 (3) 229-235.
- Alemdar Ö., Akkurt M., Ataseven Y., 2019. Bağcılıkta İyi Tarım Uygulamaları Hakkında Üreticilerin Bilgi Düzeyinin İncelenmesi: Manisa İli, Salihli İlçesi Araştırması. *COMU J. Agric. Fac.* 2019: 7 (1): 151–159 ISSN: 2147–8384 / e-ISSN: 2564–6826 doi: 10.33202/comuagri.569927.
- Altın Ö., Demiryürek K., 2021. Analysis of the Use of Information and Communication Technologies in Agricultural Extension by Members of Agricultural Growers' Associations: Tokat Example. *MAS Journal of Applied Sciences*, 6(4), 844–959.
- Altıntaş G., Altıntaş A., Bektaş H., Çakmak E., Kızılaslan H., Birol D., 2019. Effects of Young Farmer Project Support on The Tendency of Young Farmers to Stay in Agriculture: Case of TR83 Region, Turkey. *Turkish Journal of Agriculture – Food Science and Technology*, 7(10): 1682-1693, 2019.
- Aydemir A., 2019. Süt Sığırcılığı İşletmelerinin Ekonomik Analizi Artvin İli Şavşat İlçesi Örneği. Yüksek Lisans Tezi, Tokat Gaziosmanpaşa Üniversitesi, Fen Bilimleri Enstitüsü, Tarım Ekonomisi Anabilim Dalı.
- Aydın Y. K., 2020. Antalya İli Serik ve Aksu İlçesindeki Domates Üreticilerinin Sosyo Ekonomik Durumu. Yüksek Lisans Tezi, Tokat Gaziosmanpaşa Üniversitesi, Fen Bilimleri Enstitüsü, Tarım Ekonomisi Anabilim Dalı.
- Aydoğan M., Uysal O., Candemir S., Terzi YE., Raşçı R., Beşen T., Öztürk FP., Emre M., Eralp Ö., Gündüz O., Ceyhan V., 2020. Economic Performance of Rainbow Trout Farming in Turkey. *Turkish Journal of Agriculture – Food Science and Technology*, 8(9): 1952-1964, 2020.
- Aydoğdu M.H., Aydoğdu İ., Cevheri C., Sevinç MR., Küçük N., 2020. Analysis of the socio-economic profile of fodder crops producer farmers' in Şanlıurfa. *Journal of Ekonomi Türkiye Ekonomisi I Özel Sayısı* (2020) 10–15.
- Aydoğdu M. H., Altun, M., 2019. The Attitudes of Corn Producer Farmers' For The Payment For Agricultural Extension and Consultancy Services: Şanlıurfa Sampling. *Al-Farabi International Journal on Social Sciences* ISSN 2564-7946. Page 112 Volume (3), Issue (2), Year (June 2019).



- Aydođdu M. H., Yıldızođulları N., 2021. A Research on The Current Structure of The Flower Sellers and Their Perspectives on The Ornamental Plants Sector In Őanlıurfa. TURAN-CSR International Scientific, Peer-Reviewed&Refereed Journal; p-ISSN: 1308-8041, e-ISSN: 1309-4033; Year: 2021; Month: June; Volume: 13/SUMMER, Issue: 50.
- Bakır G., Kibar M., 2020. Determination of Some Structural Features of Cattle Fattening Farms in MuŐ Province. KSU J. Agric Nat 23 (6): 1687-1697.
- Bayraktar A., Boz İ., 2019. Samsun İli arŐamba İlesinde iftilerin Tarımsal Mcadele İlaları Kullanımında evreye KarŐı Tutum ve DavranıŐları. Turkish Journal of Agriculture-Food Science and Technology, 8(2): 392-398, 2020.
- Bedel N. E., 2019. Tarım ve Kırsal Kalkınmayı Destekleme Kurumu Tarafından Desteklenen Tarımsal İŐletmelerde Kırsal Kalkınma, Kalite ve Srdrlebilirlik Algısı zerine Bir Alan AraŐtırması (Bursa İli). Yksek Lisans Tezi, Bursa Uludađ niversitesi, Fen Bilimleri Enstits, Tarım Bilimleri Anabilim Dalı.
- Belen M., Yanar D., Erdal G., 2020. Determination of Plant Protection Problems on Wheat Production in Sivas Province. Turkish Journal of Agriculture – Food Science and Technology, 8(sp1): 208-214, 2020.
- BeŐen T., Sayın B., Karamrsel D., elikyurt MA., 2021. TR61 Blgesinde Gen ifti Projesi Desteđinden Yararlanmayı Etkileyen Faktrlerin Deđerlendirilmesi. International Journal of Agriculture and Wildlife Science (IJAWS)2021, 7(1): 63 – 74.
- Birsin S., 2021. TR22 Blgesi'nde Zeytin ve Zeytinyađı Sektrnde Yer Alan İŐletmelerin Sosyo-Ekonomik Analizi ve Pazar Organizasyonunun Belirlenmesi. Doktora Tezi, Tokat GaziosmanpaŐa niversitesi, Fen Bilimleri Enstits, Tarım Ekonomisi Anabilim Dalı.
- Ceyhan V., Cinemre H.A., Bozođlu B., Demiryrek K., Kılı O., 2004. Karadeniz Blgesindeki Alabalık İŐletmelerinde Ekonomik Etkinlik. Trkiye VI. Tarım Ekonomisi Kongresi 16-18 Eyll 2004 Tokat.
- akmak ., 2008. Eđitimin Ekonomiye ve Kalkınmaya Etkisi. D..Ziya Gkalp Eđitim Fakltesi Dergisi 11, 33-41 (2008).
- elik M., 2002. Strategic Analysis of Milk and Milk Products Sector at the Western Mediterranean Region. Akdeniz İİBF Dergisi, 2(4), 43-84.
- iekgil Z., Ataseven Y., 2021. “Sr Ynetimi Elemanı Benim” Projesi Kapsamındaki Tarımsal Eđitim Faaliyetlerinin Analizi. Tarım Ekonomisi AraŐtırmaları Dergisi, 7(1), 52-65.
- ifti K., Miran B., Kanberođlu Z., 2019. iftilerin Planlı retim Yapma Eđilimlerini Artıran YaklaŐımların Belirlenmesi: İzmİR İli rneđi. YYU J AGR SCI 2019, 29(1): 82-87.
- ukur T., Kızılaslan N., Kızılaslan H., 2019. Evaluation of Women Farmers Perspectives on Womens Entrepreneurship in Besni District of Adıyaman Province. International Conference on Food and Agricultural Economics 25-26 Th April 2019 Alanya, Turkey.
- Dađdemir V., 2004. Bayburt İli Kop ve Burnaz Dere Havzalarında Arıcılık Yapan İŐletmelerin Genel Durumu ve KooperatifleŐmeye BakıŐ Aısı. Trk kooperatifilik Kurumu, nc Sektr Kooperatifilik, ss.102-111, 2004.
- Demirbk M., Ayyıldız B., 2020. Kırsal Kalkınma Projelerinde Hibe Programından Yararlanmayı Etkileyen Faktrlerin Deđerlendirilmesi: Karaman İli Sarıveliler rneđi. Anadolu Journal of Agricultural Sciences, 36 (2021) ISSN: 1308-8750 (Print) 1308-8769 (Online) doi: 10.7161/omuanajas.734650.
- Dođan z B., Saner G., 2020. Kiraz retimi Yapan İŐletmelerin Makine ve Ekipman Alımlarının Desteklenmesi Programından (MEADP) Yararlanma Eđiliminin Belirlenmesi ve Devamlılıđı: İzmİR-KemalpaŐa İlesi rneđi. Tekirdađ Ziraat Fakltesi Dergisi, 18(1), 1-9.
- Dođan B., İkkat Tmer E. 2019. iftilerin İyi Tarım Uygulamalarına Katılma İstekliliklerini Etkileyen DeđiŐkenler: KahramanmaraŐ İli rneđi. Yuzuncu Yıl University Journal of Agricultural Sciences, 29(4), 611-617.
- Dođan Z., 2015. Trkiye'de Tarım Sektrnn İktisadi GeliŐimi ve Sorunları: Tarihsel Bir BakıŐ. Niđe niversitesi İktisadi ve İdari Bilimler Fakltesi Dergisi Yıl: Ocak 2015 Cilt-Sayı: 8 (1) ss: 29-41 ISSN: 2148-5801 e-ISSN 1308-4216.
- Eltez S., Eltez R. Z., 2005. Bergama ve Dikili İleleri (İzmİR) Sera Potansiyeli ve Seracılık Faaliyetleri zerine Bir AraŐtırma. Journal of Agriculture Faculty of Ege University, 42(2), 203-214.

- Erdal G, Erdal H, Ayyıldız B, Ayyıldız M, Çiçek A., 2019. Pesticide Use in Fruit-Vegetable Production and Awareness Level of Producers in Tokat Province. *Turkish Journal of Agriculture - Food Science and Technology*, 7(10): 1515-1521, 2019.
- Erdal G., Erdal H., Çiçek A., 2020. An Analysis of the Effects of Livestock Support Policies on Breeders: An Example of TR83 Region in Turkey. *Turkish Journal of Agriculture - Food Science and Technology*, 8(11), 2378–2387.
- Erdil M., Tiryaki O., 2020. Manisa İli'nde Çiftçilerin Tarım İlaçları Kullanımı Konusundaki Bilinç Düzeyi ve Duyarlılıklarının Araştırılması. *Çanakkale Onsekiz Mart Üniversitesi Fen Bilimleri Enstitüsü Dergisi*, 6(1), 81-92.
- Eryılmaz Aydın G., Kılıç O., 2021. Semt Pazarında Ürünlerini Satan Çiftçilerin Görüşleri ve Memnuniyet Durumları: Sinop İli Gerze İlçesi Örneği, Türkiye. *Turk J Agric Res* 2021, 8(2): 228-234 © TÜTAD ISSN: 2148-2306 e-ISSN: 2528-858X doi: 10.19159/tutad.898092.
- Gaytancıoğlu O., Bayraktar E., Tavl S., 2000. Tarım Kesimindeki Sosyal Güvenlik Uygulamalarının Çiftçi Üzerindeki Etkileri: Tekirdağ Örneği. IV. Ulusal Tarım Ekonomisi Kongresi 6-8 Eylül 2000 Tekirdağ.
- Gökçe O., 2004. 1000 Köye 1000 Tarımcı Projesi Üzerine Bir İnceleme. Türkiye VI. Tarım Ekonomisi Kongresi 6-18 Eylül 2004, s.609-615, Tokat.  
file:///C:/Users/Aysel-PC/Downloads/G%C3%B6k%C3%A7e,%202004.pdf
- Gökdoğan O., Bayhan AK., 2004. Eğirdir İlçesi Tarım İşletmelerinin Mekanizasyon Düzeyi. *ADÜ Ziraat Fakültesi Dergisi* 2011; 8(1) : 23 – 29.
- Gönültaş H., 2020. Tarımsal Üreticiler ve Sanayi İşletmecilerinin Çevre Sorunlarına Yönelik Algı Ve Düşüncelerinin Belirlenmesi (TR83 Bölgesi Araştırması). *Akademik Ziraat Dergisi*, Yıl 2021, Cilt 10, Sayı 2, 343 - 354, 03.12.2021.
- Gözener B., Yıldırım S., 2019. Farmers' Thoughts On Applying Different Production Techniques (Tokat Province Kazova Region Example). 3. Uluslararası Sosyal Bilimler Kongresi 28-30 Haziran 2019, Sivas.
- Gülse Bal, HS., Yüzbaşıoğlu R., Kaplan E., 2019. Fındık Üreticilerinin Tarım Sigortası Yaptırmaya Yönelik Davranışları ve Bunu Etkileyen Faktörlerin Belirlenmesi: Giresun İli Bulancak İlçesi Örneği. *Turkish Journal of Agriculture – Food Science and Technology*, 7(11): 2025-2029, 2019.
- Gültekin R., İkikat Tümer E., 2021. 6360 Sayılı Kanun İle Mahalleye Dönüştürülen Köylerde Tarımsal Üretim: Kahramanmaraş İli Örneği. *Türk Tarım ve Doğa Bilimleri Dergisi* 8(4): 974–982, 2021.
- Gündüz O., Aslan A., Ceyhan V., Bayramoğlu Z., 2020. Kuru Kayısı Tarımında Risk Yönetim Stratejisi Tercihlerini Etkileyen Faktörlerin Multivariate Probit Analizi. *Turkish Journal of Agriculture- Food Science and Technology*, 8(11): 2482-2490, 2020.
- Gündüz O., Akay M., 2003. Malatya İli Merkez İlçede Kayısı Yetiştiriciliği Yapan Tarım İşletmelerinin Ekonomik Analizi, Üretim ve Pazarlama Sorunları. *Journal of Agricultural Faculty of Gaziosmanpaşa University (JAFAG)*, 2003(1).
- İkikat Tümer E., Ağır H. B., Uslu Z., 2019. Çiftçilerin Tarım Sigortası Yaptırma İstekliliği: Konya İli Ilgın İlçesi Örneği. *Kahramanmaraş Sütçü İmam Üniversitesi Tarım ve Doğa Dergisi*, 22(4), 571-576.
- İnan H., Boyraz N., 2000. Konya Çiftçisinin Tarım İlacı Kullanımının Genel Olarak Değerlendirilmesi. *S.Ü. Ziraat Fakültesi Dergisi* 16 (30): (2002)88-101.
- İnan S., Erdal H., Erdal G., 2022. Yem Bitkisi Üreten İşletmelerin Yapısal ve Ekonomik Analizi; Tokat İli, Almus İlçesi Örneği. *Gaziosmanpaşa Bilimsel Araştırma Dergisi*, 11(2), 135-148.
- İnan S., Erdal H., Erdal G., 2022. Yem Bitkisi Üreten İşletmelerin Yapısal ve Ekonomik Analizi; Tokat İli, Almus İlçesi Örneği. *Gaziosmanpaşa Bilimsel Araştırma Dergisi*, 11(2), 135-148.
- Kan M., Kan A., Sözen Ö., Karadavut U., Yağmur, M., 2019. Evaluation of the Farms Producing Dry Bean Landraces by Capital Approach in the Middle Kızılırmak Valley of Turkey. *Characterization and Utilization* (2019) 17(5); 391–400.
- Kaplan K., Kaplan E., Gülse Bal H.S., 2019. Orman Köylülerine Yönelik Orkoy Destekleri, Üretici Memnuniyeti, Desteklerin Kullanılabilirliği ve Sürdürülebilirliği (Tokat İli Almus İlçesi Örneği). 3rd International UNIDOKAP Black Sea Symposium “Sustainable Agriculture and Environment” 21-23 June 2019, Tokat.
- Karabak S., Taşçı R., Ceyhan V., Özbek K., Yüce Arslan H., 2019. İhsangazi Tarlalarından Soframıza Kültür Mirası Siyez Buğdayı. *Toprak Su Dergisi*, 2019, Özel Sayı: (86-93) Araştırma Makalesi.



- Karabaş S., 2004. Samsun İli Çarşamba İlçesinde Sebze Yetiştiriciliği Yapan Tarım İşletmelerinin Ekonomik Analizi ve Önemli Bazı Sebzelerin Maliyet ve Karlılıklarının Belirlenmesi. Yüksek Lisans Tezi, Tokat Gaziosmanpaşa Üniversitesi, Fen Bilimleri Enstitüsü, Tarım Ekonomisi Anabilim Dalı.
- Karkacıer O., Gülse S., Oruç E., Göktolga G., 2000. Kırsal Sanayinin Kırsal Kesim Açısından Önemi ve Tokat İlinde Kırsal Sanayi Potansiyelinin İncelenmesi. IV. Ulusal Tarım Ekonomisi Kongresi 6-8 Eylül 2000 Tekirdağ. file:///C:/Users/Aysel-PC/Downloads/Karkac%C4%B1er,%20O.%20202000.pdf
- Kepek YS., 2019. Türkiye’de Uygulanan Hayvancılık Destekleme Politikalarının Tokat İlindeki Hayvancılığın Gelişimine Etkileri. Yüksek Lisans Tezi, Tokat Gaziosmanpaşa Üniversitesi, Fen Bilimleri Enstitüsü, Tarım Ekonomisi Anabilim Dalı.
- Kızılaslan N., Kızılaslan H., Solmaz E., 2021. Kırsalda Özel Sigorta Uygulamaları Konusunda Bilgi ve Düşüncelerin Belirlenmesi (Tokat İli Örneği). Gaziosmanpaşa Bilimsel Araştırma Dergisi, 10(2), 118-130.
- Kızılaslan N., Somak E., 2019. Üreticilerin Tarım Politikalarına İlişkin Görüş Ve Beklentilerinin Belirlenmesi (Tokat İli Merkez İlçe Köyleri Örneği). Gaziosmanpaşa Bilimsel Araştırma Dergisi Cilt/Volume : 8 Sayı/Number: 3 Yıl/Year: 2019 Sayfa/Pages:140-154.
- Kızılaslan N., Kızılaslan H., Solmaz E., 2021. Kırsalda Özel Sigorta Uygulamaları Konusunda Bilgi ve Düşüncelerin Belirlenmesi (Tokat İli Örneği). Gaziosmanpaşa Bilimsel Araştırma Dergisi (Gbad) Gaziosmanpaşa Journal of Scientific Research 10(2), 118-130. ISSN: 2146-8168.
- Kıracı M. A., 2001. Tekirdağ İli Şarköy İlçesi Bağcılığının Mevcut Durumu, Üreticilerin Sorunlarının Çözümüne İlişkin Örgütlenme Olanaklarının Belirlenmesi. Yüksek Lisans Tezi, Trakya Üniversitesi, Fen Bilimleri Enstitüsü, Tarım Ekonomisi Anabilim Dalı.
- Koyubenbe N., 2005. İzmir İli Ödemiş İlçesinde Süt Sığırcılığının Geliştirilmesi Olanakları Üzerine Bir Araştırma. Hayvansal Üretim 46(1): 8-13, 2005.
- Köksal H., 2019. Samsun İlinde Tarımsal Kredi Kullanımının Analizi. Doktora Tezi, Ondokuz Mayıs Üniversitesi, Fen Bilimleri Enstitüsü, Tarım Ekonomisi Anabilim Dalı.
- Kurt Y. A., Boz İ. 2021. Örtü Altı Sebze Yetiştiriciliğinde Kullanılan Bilgi Kaynakları: Samsun İli Çarşamba İlçesi Örneği. Kahramanmaraş Sütçü İmam Üniversitesi Tarım ve Doğa Dergisi, 24(4), 895-903.
- Kurtaslan T., Oruç E., Çiçek A., 2000. Tokat İlinde Çiftçilerin Çevre Sorunları Konusundaki Bilgi ve Bilinç Düzeyleri, Konuya İlişkin Yaklaşımlarının Değerlendirilmesi. IV. Ulusal Tarım Ekonomisi Kongresi 6-8 Eylül 2000 Tekirdağ.
- Oruç E., Gözener B., 2020. Plastik Seralarda Domates Yetiştiriciliğinin Ekonomik Analizi, Türkiye’de Antalya İli Örneği. Custos e @gronegocio on line - v. 16, n. 3, Jul/Set - 2020. ISSN 1808-2882.
- Oruç E., 2001. Tokat İlinde Bitkisel Üretimde Tarımsal Mücadele Uygulamaları ve Çiftçilerin İlaç Kullanımı Konusundaki Bilgi Düzeyleri İle Bilgi Kaynakları Üzerine Bir Araştırma. Doktora Tezi, Tokat Gaziosmanpaşa Üniversitesi, Fen Bilimleri Enstitüsü, Tarım Ekonomisi Anabilim Dalı.
- Öz K., Kızılaslan N., 2019. Besi Sığırcılığında Tarım Kredi Kooperatiflerinin Rolü: Sinop İli Erfelek İlçesi Araştırması. Gaziosmanpaşa Bilimsel Araştırma Dergisi, 8(1), 74-90.
- Özbek H., 2019. Tarımsal Biyoçeşitliliğinin Korunmasında Yerel Tohum Kullanımı ve Üretici Farkındalığı (Ankara İli Ayaş İlçesi Örneği). Yüksek Lisans Tezi, Tokat Gaziosmanpaşa Üniversitesi, Fen Bilimleri Enstitüsü, Tarım Ekonomisi Anabilim Dalı.
- Özdemir Y., Kınıklı F., Engindeniz S., 2021. Süt Sığırcılığı İşletmelerinin Yapısal Özellikleri ve Sorunları Üzerine Bir Araştırma: Balıkesir’in Gönen İlçesi Örneği. Türk Tarım ve Doğa Bilimleri Dergisi 8(4): 1001-1011, 2021.
- Özer D., İkikat Tümer E., 2020. Limon Üreticilerinin Risk Karşısındaki Tutumlarını Etkileyen Faktörlerin Analizi: Mersin İli Erdemli İlçesi Örneği. Türk Tarım ve Doğa Bilimleri Dergisi 7(4): 988-996, 2020.
- Özer M., 2005. Şanlıurfa Agro-Gap Önder Çiftçi Danışmanlık Derneği’nin Tarımsal Yayım Çalışmaları ve Etkisinin Değerlendirilmesi Üzerine Bir Araştırma. Yüksek Lisans Tezi, Harran Üniversitesi, Fen Bilimleri Enstitüsü, Tarım Ekonomisi Anabilim Dalı, Şanlıurfa.
- Öztürk N., 2005. İktisadi Kalkınmada Eğitimin Rolü. Sosyoekonomi Ocak-Haziran, 2005. <https://dergipark.org.tr/tr/download/article-file/197573>



- Özkan, B., Akçaöz Vuruş, H., Karadeniz, F.C., 2002. Antalya İli Turunçgil Üretiminde Tarımsal İlaç Kullanımının Ekonomik Analizi. Türkiye V. Tarım Ekonomisi Kongresi 18-20 Eylül 2002 Erzurum.
- Özkan E., Aydın B., Kayhan İ.E., 2002. Trakya'daki Bazı Sulama Sahalarında Çiftçilerin Sulamaya Eğilimi ve Buna Etkili Sosyo Ekonomik Faktörler. Türkiye V. Tarım Ekonomisi Kongresi 18-20 Eylül 2002 Erzurum.
- Özkan E., Arslankurt B., Altun A., Altıntaş A., Şelli F., Aktaş E., 2004. Orta Fırat Havzasındaki Havza Rehabilitasyon Projesi Uygulama Alanlarında Üreticilerin Sosyo Ekonomik Özellikleri İle İlgili Bir Araştırma. Türkiye VI. Tarım Ekonomisi Kongresi 16-18 Eylül 2004 Tokat.
- Salalı E., Atış E., Günden C., 2019. Su Kaynaklarının Korunmasında Yerel Tohum Çeşitlerinin Rolü Üzerine Çiftçi Görüşleri. Tarım Ekonomisi Dergisi, 25(2), 133-139.
- Sayın B., Bayav A., Beşen T., Karamürsel D., 2020. Üreticilerin Biyolojik ve Biyoteknik Mücadele Uygulamalarına Bakışı ve Çevre Duyarlılıklarının Belirlenmesi. Kahramanmaraş Sütçü İmam Üniversitesi Tarım ve Doğa Dergisi, 23(2), 453-466.
- Semerci A., Çelik, A.D., 2019. Türkiye'de Pamuk Üretimine Ekonomik Analizi: Hatay İli Örneği. Turkish Journal of Agriculture – Food Science and Technology, 7(2): 246-252, 2019.
- Sezener B., 2005. Türkiye'de Zeytinyağına Uygulanan Destekleme Politikalarının Aydın İli Zeytin Ekonomisine Etkisi. Yüksek Lisans Tezi, Aydın Adnan Mendres Üniversitesi, Fen Bilimleri Enstitüsü, Tarım Ekonomisi Anabilim Dalı.
- Şahin A., Çakır C., Yıldırım İ., 2004. Van Yöresindeki Kırsal Alanlarda Nüfus ve Eğitime İlişkin Sorunlar ve Bazı Çözüm Önerileri. file:///C:/Users/Aysel-PC/Downloads/%C5%9Eahin,%20A.%202004%20(1).pdf
- Şahin K., 2000. Kayseri İlinde Süt Sığırcılığı Yapan İşletmelerin Yapısal Özellikleri ve Pazarlama Sorunları. Yüzüncü Yıl Üniversitesi, Ziraat Fakültesi, Tarım Bilimleri Dergisi (J. Agric. Sci.), 2001, 11(1):79-86.
- Şahinler N., Şahinler S., 2002. Hatay İl'inde İpekböceği Yetiştiriciliğinin Mevcut Durumu Sorunları ve Çözüm Önerileri Üzerine Bir Araştırma. MKÜ Ziraat Fakültesi Dergisi 7 (1-2): 95-104, 2002.
- Şahinli M. A., 2019. Tarımsal Sulamaların Ekonomik ve Sosyal Etkilerinin Değerlendirilmesi: Asartepe Barajı Üzerine Bir Uygulama. Anadolu Tarım Bilimleri Dergisi, 34(2), 146-155.
- Şelli F., Çelik S., 2000. GAP Bölgesi Harran Ovasında Sulamaya Yeni Açılan Alanlarda Tarımsal Yayım Çalışmalarının Değerlendirilmesi ve Etkinliğinin Arttırılması. IV. Ulusal Tarım Ekonomisi Kongresi 6-8 Eylül 2000 Tekirdağ.
- Şimşek Y. B., Armağan, G., 2020. Tarımsal Yayım ve Danışmanlık Hizmetlerinde Algılanan Hizmet Kalitesi: Aydın İlinde Bir Uygulama. Organizasyon ve Yönetim Bilimleri Dergisi, 12(2), 150-169.
- Tanrıvermiş H., 2000. Orta Sakarya Havzası'nda Domates Üretiminde Tarımsal İlaç Kullanımının Ekonomik Analizi. TEAE, Yayın No: 42, Ankara.
- Terzi O., Artukoğlu M., 2021. A Research on Farmers Income and Financial Status, and Alternative Finance Proposals. Ege Univ. Ziraat Fak. Derg., 58 (3):445-455.
- Topal E., Adanacioğlu H., Karaman S., Kösoğlu M., Bayar F., 2019. Arcılık İşletmelerinin Bilgi Transfer Kaynakları: İzmir İli Örneği. ASEAD Cilt 7 Sayı 1 Yıl 2020, S 150-161.
- Torgut E., Annayev S., Örmeci Kart MÇ., Türkekul B., 2019. Süt Sığırcılığı Yapan İşletmelerin Genel Yapısı, Sorunları ve Çözüm Önerileri: İzmir İli Ödemiş ve Tire İlçeleri Örneği. Tarım Ekonomisi Dergisi Cilt:25 Sayı:1 Sayfa:87-95.
- Torun E., Taluğ C., 2005. Çay Budama Projesi Kapsamında Üreticilerin Kullandıkları Bilgi Kaynakları. Tarım Ekonomisi Dergisi, 11(1 ve 2), 41-49.
- Uçkaç A., 2009. Ekonomik Kalkınma ve Küreselleşme Sürecinde Eğitim. İstanbul Üniversitesi Sosyal Bilimler Enstitüsü Maliye Anabilim Dalı Doktora Tezi.
- Uslu T., 2019. Türkiye'de Uygulanan Prim Sisteminin Analizi, Üretici Açısından Değerlendirilmesi (Osmaniye/Kadirli İlçesi Örneği). Yüksek Lisans Tezi, Tokat Gaziosmanpaşa Üniversitesi, Fen Bilimleri Enstitüsü, Tarım Ekonomisi Ana Bilim Dalı.
- Uzmay A., Durmaz S., Özümlü AE., 2001. Mordoğan'da Nergis (Narcissus poeticus) Yetiştiriciliği Sorunları Üzerine Bir Araştırma. Ege Üniv. Ziraat Fak. Derg., 2001, 38(1):39 -46 ISSN 1018-8851.
- Veziroğlu P., Emeksiz F., 2020. Çukurova Bölgesinde Turunçgil Üreticilerinin Üretim Süreçlerindeki Kararlarının Ekonometrik Analizi. Tarım Ekonomisi Dergisi Cilt:26 Sayı:2 Sayfa: 89-99.

V. International Applied Statistics Congress (UYIK - 2024)  
Istanbul / Turkey, May 21-23, 2024

- Yavuz O., Orkun E.A., 2004. Eskişehir İli Alpu İlçesi'nde Arazi Toplulaştırması Yapılan Köylerde Sosyo-Ekonomik Yapı Ve Yeniliklerin Benimsenme Düzeyi. Türkiye VI Tarım Ekonomisi Kongresi 16-18 Eylül 2004 Tokat.
- Yıldız Ö., 2019. Diyarbakır İlinde Faaliyet Gösteren Bağcılık İşletmelerinin Yapısı, Üretim ve Pazarlama Sorunları. Yüksek Lisans Tezi, Tokat Gaziosmanpaşa Üniversitesi, Fen Bilimleri Enstitüsü, Tarım Makineleri Ana Bilim Dalı.
- Yılmaz E., Turgut U., Tosun D., Gümüş S., 2020. İzmir İlindeki Çiftçilerin Kırsal Nüfusun Yaşlanma Eğilimi ve Tarımsal Faaliyetlerin Devamlılığına İlişkin Görüşleri. Turkish Journal of Agricultural Economics Volume: 26 Issue: 2 Page: 109-119.
- Yüzbaşıoğlu R., Kızılaslan H., 2020. Tokat İli Turhal İlçesi Hayvansal Destekleme Kullanan Üretici Memnuniyetini Etkileyen Faktörlerin Belirlenmesi. (GBAD) Gaziosmanpaşa Journal of Scientific Research Volume: 9 Number: 1 Year: 2020 Pages: 1-12.



## Machine Faults Detection with Nonlinear Features for Predictive Maintenance Applications

Ahmet Mert Demirbaş<sup>1\*</sup>, Derya Yılmaz<sup>2</sup>

<sup>1</sup> Turkish Aerospace, Deputy General Manager of Engineering, Flight Test Instrumentation, 06980, Ankara, Türkiye. ORCID ID: 0000-0001-6878-4495

<sup>2</sup> Gazi University, Engineering Faculty, Department of Electrical and Electronics Engineering, 06570, Ankara, Türkiye. ORCID ID: 0000-0001-5141-2572

\*Corresponding author e-mail: ahmetmertdemirbas@gmail.com

### Abstract

*The increasing need for industrial mechanization and diversity of machinery, creating accurate maintenance strategies involving smart technologies has become a significant requirement to ensure continuity in production or service. With predictive maintenance, it is possible to increase efficiency by avoiding additional costs and time losses resulting from traditional maintenance methods or repairs made after problems occur in the machine. The aim of this study is to propose an approach aimed at detecting any maintenance-requiring faults on equipment used with the predictive maintenance concept before the device breaks down. Many studies in the literature had shown that physical measurements such as vibration, sound, and temperature provide information about the machine's fault condition, especially for an electric motor. In this study, the MAFAULDA dataset containing three-axis vibration data from two acceleration sensors at different RPM values was used to examine normal conditions of an electric motor as well as scenarios with horizontal misalignment, imbalance, bearing faults, and vertical misalignment faults. In this study, in addition to the features calculated in the time and frequency domains of acceleration data, some features that have not been used before for this data were used based on nonlinear analysis. These features include average mutual information, Higuchi dimension, Katz dimension, and entropy. Features obtained from both sensors were used for multi-class classification for 10 different fault classes using the MATLAB Classification Learner application, and an accuracy of 99.1% was achieved with the Decision Trees classifier. Then, the classification was made by reducing the number of sensors to one and a 96.1% accuracy rate was achieved with the Decision Trees classifier. When similar studies in the literature are examined, this study achieved the highest classification accuracy achieved with a single sensor. The results obtained in the study are important as they show that nonlinear features provide information that supports the use of fewer sensors.*

**Keywords:** Predictive Maintenance, Classification, Vibration, Electric Motor, Machine Learning.

### INTRODUCTION

Machine diversity has increased in recent years with developing technology. Although mechanization in the industry provides time and cost savings in production, it has also created extra maintenance costs with the increasing importance of maintenance. Three maintenance concepts have been widely examined in the literature: periodic, reactive and predictive maintenances. The maintenance periods provided by the manufacturer of the machine are specified to the user for periodic maintenance. The user performs maintenance by complying with these periods. Periodic maintenance creates a negative



situation in terms of time and cost because early maintenance is carried out on healthy machines. The maintenance performed after a malfunction occurs on the machine is corrective maintenance. Since this maintenance is performed after the device breaks down, it does not provide an effective method in terms of time and cost. Predictive maintenance has become increasingly popular in recent years. Predictive maintenance has surpassed other maintenance methods by accurately determining the timing of maintenance on the machine. (Azari et al., 2023). In this method, physical measurements such as vibration, sound and temperature taken on the machine provide a lot of information about the health of the machine. Vibration is regarded as the most effective indicator of the machine's current condition, as it is highly sensitive to the early detection and progression of defects. The vibration signals comprise diverse responses originating from various sources within the machinery. Effective and efficient feature extraction techniques are essential for rotating machinery defect detection. The next stage is to use supervised machine learning techniques to find and diagnose defects in rotating machinery after these critical attributes have been found. Based on the features that are retrieved from the measured data signals, the classification algorithms group the signals into different fault classes.

Many studies examine different approaches to feature extraction that make use of time-domain, frequency-domain, and time-frequency domain analysis, and they demonstrate how these approaches affect the classification algorithm's accuracy. Neural networks (NN), random forests (RF), k-nearest neighbors (KNN), and support vector machines (SVM) are among the most often used classifying techniques. The studies demonstrate how crucial feature selection is to the effectiveness of intelligent fault diagnostics. In order to provide a thorough comparison, (Han et al., 2018) extract three classes: time-domain statistical features (TDF), frequency-domain statistical features (FDF), and multiple scale features (MCF) for model training. The accuracy of RF, artificial neural networks (ANN), and SVM for identifying bearing and gear problems is also tested. Time and frequency-domain analysis is used by (Yang et al., 2003) and (Kiral and Karagülle, 2003) to carry out fault diagnostics in rolling bearings. (Hoffman and Merwe, 2002) tested the classification algorithms with different feature combinations using six time-domain and four frequency-domain features. (Dalpiaz et al., 1998) demodulate the vibration signal for gear fault monitoring using novel techniques based on time-frequency analysis and time synchronous averaging (TSA) approach. The SVM model is used by (Bordoloi and Tiwari, 2014) to examine a gearbox's multifault categorization. In another study, time and frequency domain features were calculated and among these features, error classification was made by selecting features together with neighborhood component analysis (Ignjatovska et al., 2023).

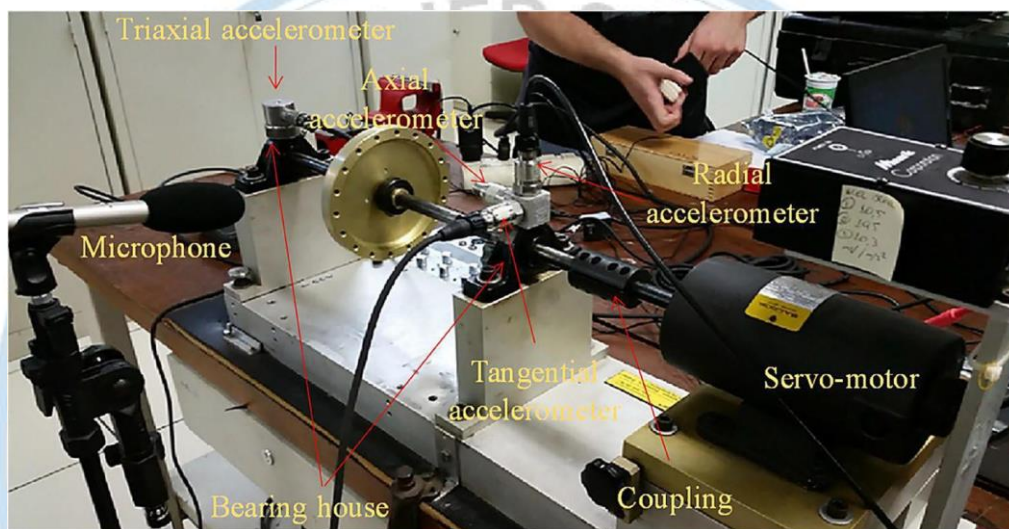
This study examined the normal conditions of an electric motor as well as scenarios with horizontal misalignment, imbalance, bearing faults, and vertical misalignment faults using the MAFAULDA dataset, which contains three-axis vibration data from two acceleration sensors at varying revolutions per minute (rpm) values. MAFAULDA is an open-source vibration data set that was collected by researchers in papers (Marins et al., 2018) and (Pestana-Viana et al., 2016) using a SpectraQuest machine simulator under ten unique operating circumstances. In this work, several characteristics that were previously not utilized for this data were employed based on nonlinear analysis, in addition to the features computed in the time and frequency domains of acceleration data. These features include entropy, Higuchi dimension, Katz dimension, and average mutual information. The MATLAB Classification Learner tool and selected features by ANOVA were used to classify ten distinct fault classes into multiple classes.

## **MATERIAL AND METHODS**

### **Material**

Electrical and mechanical faults are the two main categories of faults in electrical machinery. The three main types of electrical faults are winding ground faults, open circuits, and short circuits. Mechanical

defects include eccentricity, misalignments, and bearing wear and deformation. This research examines an electrical machine fault dataset that includes information for one mechanical fault class and five healthy fault classes. Two three-axis accelerometers captured vibration signals for two sites of bearing problems, imbalance errors, vertical misalignment, horizontal misalignment, and a normally running case. Vibration signals are used at 49 speeds in the healthy working data class, covering 737 rpm to 3686 rpm. The vibration data from 44 revolutions generates 333 imbalance data classes for imbalance situations with seven distinct weights ranging from 6g to 35g. There are 197 and 301 data points for the horizontal and vertical misalignments caused by the motor shaft slipping, respectively. In order to practically detect bearing defects, vibration signals are recorded using artificially produced imbalances in 50 kHz for 5 seconds duration. There are 513 data for the overhang position, where the rotor is in the middle, and 558 data for the underhang position, where the bearing is between the motor and the rotor. Figure 1 illustrates the configuration of the experiment (Marins et al., 2018).



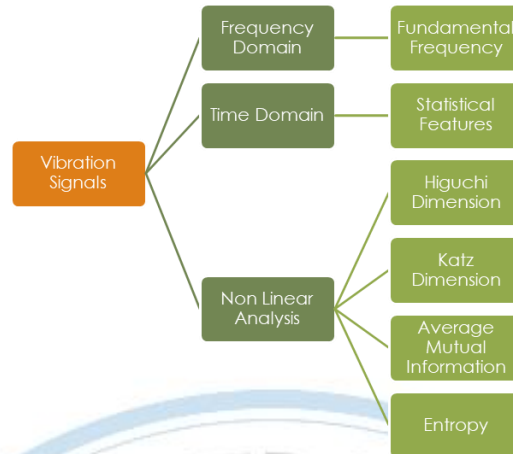
**Figure 1.** SpectraQuest experimental testbench system.

The six vibration signals that were captured for two positions axially, radially, and tangentially were assessed independently. In this study every vibration signal was split into 1-second segments so the dataset has grown five times larger since each of these one-second vibration signals is now treated as a distinct signal.

## Methods

### *Feature Extraction*

A time-domain vibrational signal measurement process is used in rotating equipment fault diagnostics. These signals are stochastic, therefore utilizing these in their raw state is insufficient to determine the state of the mechanism at that moment. The essential features of the signal are retrieved from the time-domain and frequency-domain data. Six axes of two sensors were used to extract the following time domain features: mean, standard deviation, maximum, minimum, skewness, and kurtosis. The frequency domain feature includes fundamental frequency, which is calculated with the Welch method. In this study, in addition to the features calculated in the time and frequency domains of acceleration data, some features that have not been used before for this data were used based on nonlinear analysis. These features include average mutual information, Higuchi and Katz dimension, and entropy. Figure 2 illustrates the features from different domains in this study.



**Figure 2.** Calculated features.

The Higuchi and Katz dimensions are the methods coming from nonlinear analysis and provides the measure of the complexity of the signals in time series. Mutual information refers to the amount of information one signal provides about the time delayed versions of the signal. This calculation is used specifically to understand the relationship between time delayed copies of the signal and measure the exchange of information (Wallot and Mønster, 2018). This measurement is important to understand the dynamics of the relationship between the signal copies over time, especially in time series analysis. Entropy in time series signals refers to a measure of uncertainty or disorder within the data. It's a concept borrowed from information theory and is used to quantify the unpredictability or randomness in a time series. Higher entropy indicates greater unpredictability or disorder. Three types of entropies are used in this study: Shannon, approximate, and sample. Shannon entropy is a measure of uncertainty of a probability distribution. It measures the regularity of a system. Approximate entropy is a metric that measures the complexity of a time series. It expresses the balance between disorder and predictability. Sample entropy is similar to approximate entropy but is computationally simpler.

#### *Features with the Highest Level of Importance*

Only the most significant time-domain, frequency, and non-linear domain variables should be selected and used as input for the classification algorithms, as not all of them are equally important for identifying different types of machinery failures. ANOVA is used in this study as a technique for selecting extracted features with the highest weight factor to maximize the classification algorithm's prediction accuracy.

#### *Classification*

The retrieved features that were previously discussed are fed into the training and testing processes of different classification algorithms. MATLAB is used for training and testing the models that use different classifiers based on supervised machine learning to classify data. These classifiers include SVM, decision trees (DT) and ensemble classifiers. SVM aim to find the optimal hyperplane that separates data points and perform well in high-dimensional datasets; however, they have high computational costs for large datasets and challenging parameter selection. DTs classify or regress by



splitting data based on features, making them easy to understand and interpret, but they suffer from overfitting and instability (Nti et al., 2020). Each of these algorithms is suitable for specific problem types and data structures, and in practice, the algorithm with the best performance is typically chosen.

Scatter plots of the data are obtained in order to visualize the features' capacity to distinguish between the ten various fault circumstances prior to beginning the training of the classification algorithms. Figure 3 shows the distribution of 10 different error cases, with different features.

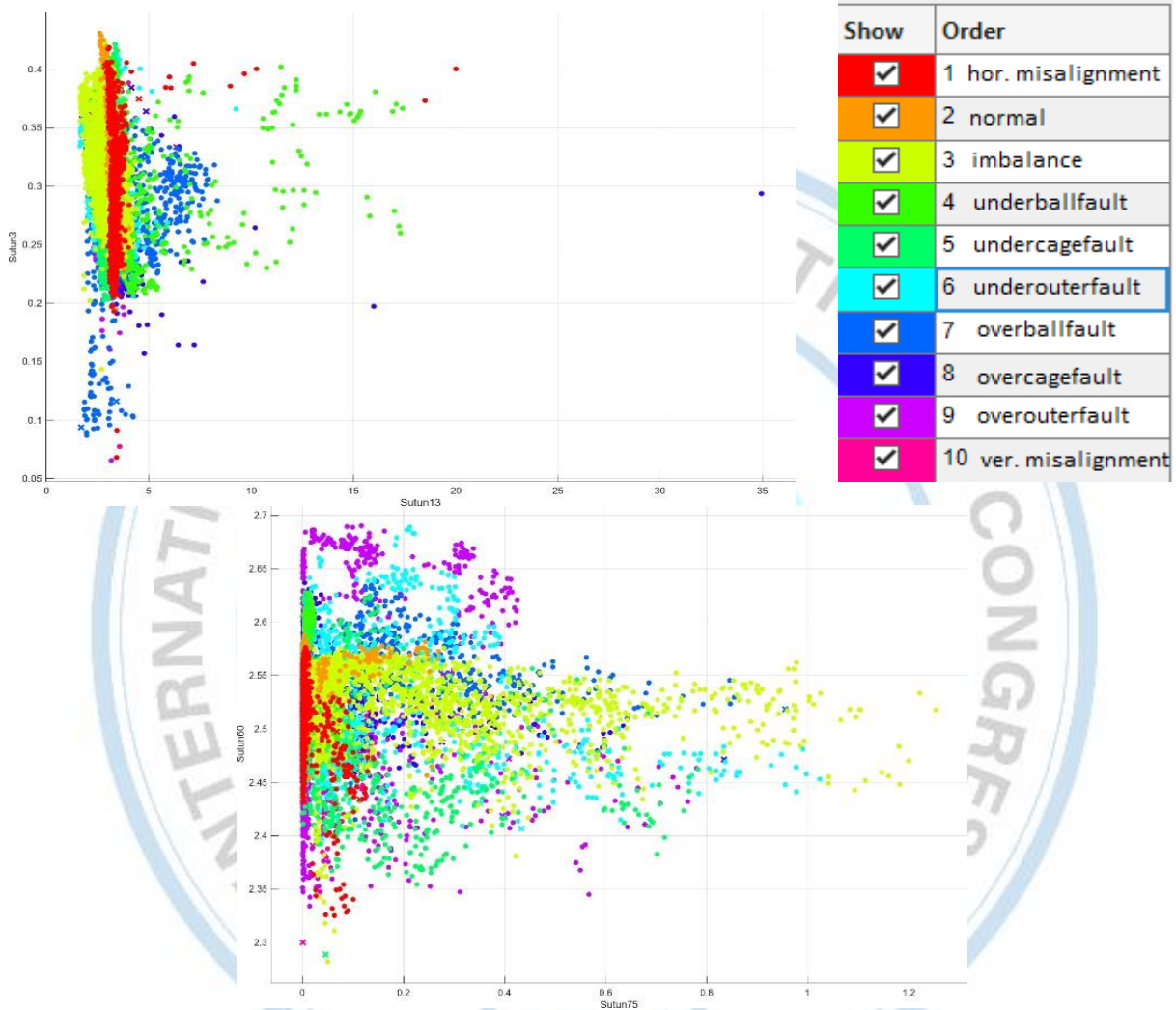


Figure 3. Two scatter plots and error cases

## RESULTS

The normal state and five fault classes are categorized using three-axis accelerometers, as was previously described, which are positioned in two distinct locations on the experimental setup. The classifier has been supplied axial, radial, and tangential values from each location independently to determine which accelerometer position will produce the best results. There are two different parts in this study. In the first part, features calculated from 6 axes of 2 sensors were used and a total of 44 features were selected. The features were selected using the ANOVA feature selection algorithm, and the average, maximum, minimum and standard deviation properties of the axes data were removed. After testing several classifiers, the decision tree classifier produced the best accuracy when choosing

the maximum number of splits 9755, the number of learners 30, and the learning rate 0.5. The classification learner that showed the highest accuracy in distinguishing between the analyzed 10 fault conditions are DTs with an accuracy of %99,1. Figure 4 shows us the confusion matrix of decision trees.

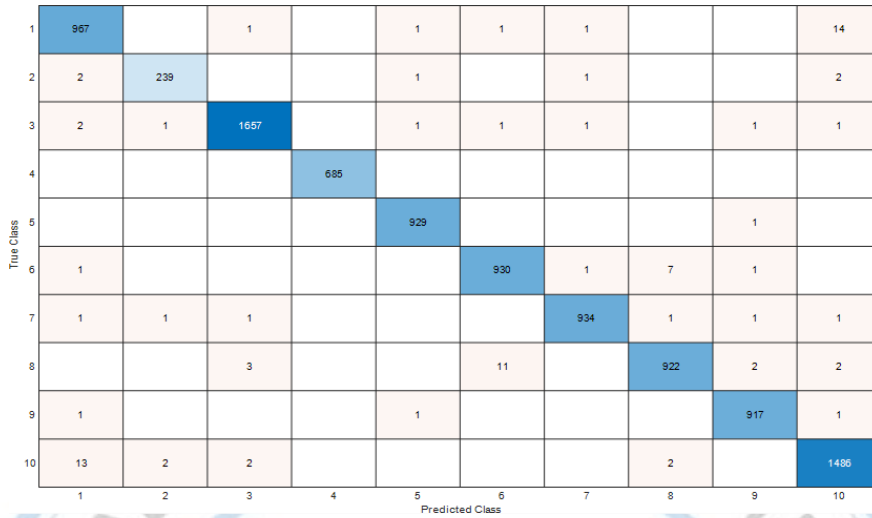


Figure 4. Confusion matrix of decision trees method for 2 sensors

In the second part, features were extracted using the axial values of only one vibration sensor. The features do not include statistical features, and a total of 24 features were used. When selecting the maximum number of splits (9755), the number of learners (30), and the learning rate (0.5), the decision tree classifier achieved the best accuracy. Figure 5 shows us the confusion matrix of decision trees.

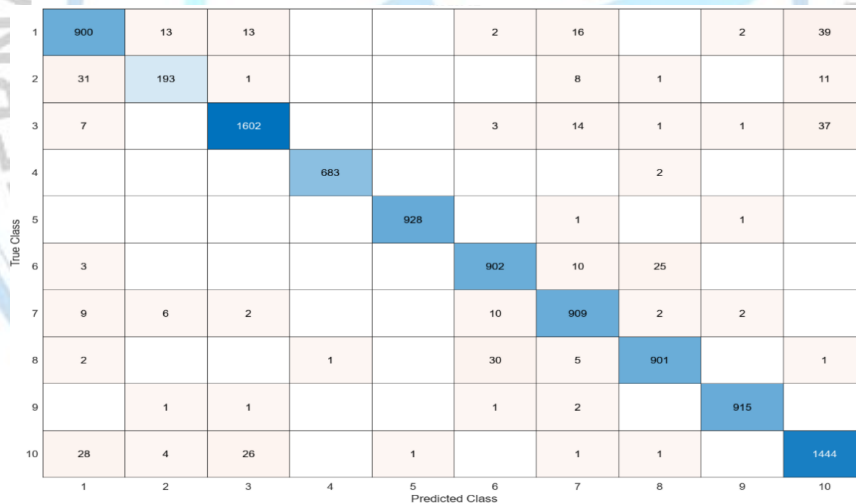


Figure 5. Confusion matrix of decision trees method for one sensor

As a result, the best accuracy, sensitivity and specificity scores of the 2 different methods are given in Table 1 below.

Table 1. Accuracy, sensitivity and specificity values of methods

Method	Classifiers	Accuracy	Sensitivity	Specificity
2 Sensors (Sensor Location: Overhang - Underhang)	Bagged Trees	99.10%	0.99	0.99
	Cubic SVM	57.10%	0.53	0.94
1 Sensor (Sensor Location: Overhang)	Bagged Trees	96.10%	0.95	0.99
	Cubic SVM	76.50%	0.73	0.97

## DISCUSSION AND CONCLUSION

This study focuses on fault classification in electric motors, one of the most important equipment of modern industry. In this study, a data set containing healthy, horizontal misalignment, vertical misalignment, imbalance and different bearing faults was used to classify the fault situations. Vibration measurements, including a total of 6 axes, were taken from 2 different locations in different error situations. In this work, several features that were previously unutilized for this data were employed based on nonlinear analysis, in addition to the features computed in the time and frequency domains of acceleration data. Entropy, Higuchi dimension, Katz dimension, and average mutual information are some of these features. Two different studies were conducted in this study. In the first part of this study, using the MATLAB Classification Learner tool, features from both sensors were used to generate a multi-class classification for ten distinct fault classes. The DT classifier produced a 99.1% accuracy rate. In the second section of the study, the DT classifier produced an accuracy rate of 96.1% when the number of sensors was reduced to one. This study produced the highest classification accuracy with a single sensor when compared to similar studies in the literature. The results of the research are significant because they demonstrate that nonlinear features offer data that supports the usage of fewer sensors.

## References

- Azari M. S., Flammini F., Santini S., Caporuscio M., 2023. A Systematic Literature Review on Transfer Learning for Predictive Maintenance in Industry 4.0. *IEEE Access*, 11: 12887-12910.
- Han T., Jiang D., Zhao Q., Wang L., Yin K., 2018. Comparison of random forest, artificial neural networks and support vector machine for intelligent diagnosis of rotating machinery. *Transactions of the Institute of Measurement and Control*, 40(8): 2681-2693.
- Yang H., Mathew J., Ma L., 2003. Vibration feature extraction techniques for fault diagnosis of rotating machinery: a literature survey. *Asia-Pacific Vibration Conference*, 12-14 November 2003, Page: 801-807, Gold Coast, Australia.
- Kiral Z., Karagülle H., 2003. Simulation and analysis of vibration signals generated by rolling element bearing with defects. *Tribology International*, 36(9): 667-678.
- Hoffman A. J., Merwe N.T., 2002. The application of neural networks to vibrational diagnostics for multiple fault conditions. *Computer Standards and Interfaces*, 24(2):139-149.
- Dalpiaz G., Rivola A., Rubini R., 1998. Gear fault monitoring: comparison of vibration analysis Techniques. *Proceedings of the 3rd International Conference on Acoustical and Vibratory Surveillance Methods and Diagnostic Techniques*, 13(3): 623-637.
- Bordoloi D. J., Tiwari R., 2014. Support vector machine based optimization of multi-fault classification of gears with evolutionary algorithms from time-frequency vibration data. *Measurement*, 55: 1-14.
- Ignjatovska A., Shishkovski D., Pecioski D., 2023. Classification of present faults in rotating machinery based on time and frequency domain feature extraction. *Vibroengineering Procedia*, 51:22-28.
- Marins M. A., Ribeiro F. M., Netto S. L., Da Silva E. A., 2018. Improved similarity-based modeling for the classification of rotating-machine failures. *Journal of the Franklin Institute*, 355(4): 1913-1930.
- Pestana-Viana D., Zambrano-Lopez R., de Lima A. A., De M. Prego T., Netto S. L., da Silva E. A., 2016. The influence of feature vector on the classification of mechanical faults using neural networks. *IEEE 7th Latin American Symposium on Circuits & Systems (LASCAS)*, 27 February-1 March 2016, Page: 115-118, Florianopolis, Brazil.
- Wallot S., Mønster D., 2018. Calculation of Average Mutual Information (AMI) and False-Nearest Neighbors (FNN) for the Estimation of Embedding Parameters of Multidimensional Time Series in Matlab. *Frontiers in Psychology*, 9:1679.
- Nti I. K., Adekoya A. F., Weyori B. A., 2020. A comprehensive evaluation of ensemble learning for stock-market prediction. *Journal of Big Data*, 7(1):20.



## Adalet Kavramı ve Adalette İstatistiğe Duyulan İhtiyaç

**İbrahim Özbay<sup>1\*</sup>, Yalçın Tahtalı<sup>2</sup>**

<sup>1</sup> University of Gaziosmanpaşa, Faculty of law, Tokat, Türkiye

<sup>2</sup> University of Gaziosmanpaşa, Faculty of Agriculture, Tokat, Türkiye

\*Sorumlu yazar e-mail: ibrahim.ozbay@gop.edu.tr

### Özet

Adalet kelimesi sözlüklerde “hak ve hukuka uygunluk”, “herkese kendine uygun düşeni, kendi hakkı olanı verme”, “insaf etme”, “kanunlarla sahip olunan hakların herkes tarafından kullanılması”, “doğruluk”, “denge”, “eşitlik” gibi anlamlarda kullanılmaktadır. Başka hiçbir soru, adalet terimi kadar tutkulu bir şekilde tartışılmamış; başka hiçbir soru böylesine çok kan ve gözyaşı dökülmesine sebep olmamış ve başka hiçbir soru Eflatun’dan Kant’a en ünlü düşünürlerin yoğun ilgisine konu olmamıştır. Ancak başka hiçbir soru bugün, diğer zamanlarda olmadığı kadar da cevapsız kalmamıştır. Felsefeciler, özellikle hukuk felsefecileri, genelde hukukun en temel idesi olarak niteledikleri adaletin tanımlanmasının zor, hatta imkânsız olduğunu ifade etmişlerdir. Müslüman bilginler açısından ise adalet esas itibarıyla tanımlanabilir ve gerçekleştirilebilir bir şeydir. “Adalet nedir?” sorusuna, İslam bilginleri genel olarak “Adalet dengedir, orta noktadır” cevabını vermişlerdir. Modern hukuk açısından adalet ise, “insan ilişkilerini düzenleyen toplumsal kuralların içinde en ideal değer ölçüsü” olarak tanımlanmaktadır.

Adalet sisteminin işleyişi ile ilgili eksikliklerin ve aksaklıkların giderilip düzeltilmesi, ileriye yönelik plan ve programların yapılması, yeni projelerin üretilmesi sürecinde bu alanla ilgili olarak göstergelere ihtiyaç duyulacağı inkâr edilemez bir gerçektir. Bu göstergelerin hesaplanmasında kullanılan verilerin önemli bir kısmını adalet istatistiklerinde bulmak mümkündür. Bu anlamda adalet istatistiklerinin hukuk ile istatistik biliminin kesişme noktası olduğunu söylemek mümkün olabilecektir. Adalet istatistikleri, özellikle devletin adli / idari vakalar karşısında ne gibi tedbirler alacağına somutlaşması bakımından önem kazanmaktadır. Örneğin bilişim yoluyla hırsızlık veya dolandırıcılık suçlarının veya suç işleme yöntemlerinin sayısal olarak artması, hükümetleri/ devletleri bu konuda yasal düzenleme yapmaya sevk edecektir. Bu suretle kişilerin mağduriyetlerinin giderilmesine katkıda bulunulacaktır. Aynı şekilde boşanma davalarının artması durumunda, ailenin korunmasına ilişkin tedbirlerin de artırılması ve devletin aileyi koruyucu her türlü yasal düzenlemeyi yapması kaçınılmaz olacaktır.

**Anahtar Kelimeler:** Adalet, yargısal sistem, istatistik, adalet istatistikleri

### Abstract

The word justice is used in dictionaries with meanings such as "fairness and compliance with the law", "giving everyone what is appropriate to them, what is their right", "fairness", "use of the rights granted by law by everyone", "correctness", "balance", "equality". is used. No other question has been more passionately debated than the term justice; No other question has caused so much blood and tears to be shed, and no other question has been the subject of the intense attention of the most famous thinkers from Plato to Kant. But no other question remains unanswered today more than at any other time.

Philosophers, especially legal philosophers, have stated that justice, which they generally describe as the most fundamental idea of law, is difficult or even impossible to define. For Muslim scholars, justice is essentially something that can be defined and realised. “What is justice?” To the question, Islamic scholars generally answered, "Justice is balance, the middle point." In terms of modern law, justice is defined as "the most ideal measure of value among the social rules regulating human relations".

*It is an undeniable fact that indicators related to this field will be needed in the process of eliminating and correcting the deficiencies and disruptions in the functioning of our justice system, making future plans and programs, and producing new projects. It is possible to find a significant part of the data used in the calculation of these indicators in justice statistics. In this sense, it may be possible to say that justice statistics are the intersection point of law and statistics. Justice statistics gain importance, especially in terms of concretizing what measures the state will take against judicial / administrative cases. For example, the numerical increase in theft or fraud crimes or crime methods through IT will prompt governments/states to make legal regulations on this issue. In this way, it will contribute to eliminating people's grievances. Likewise, if divorce cases increase, it will be inevitable for the measures to protect the family to be increased and for the state to make all kinds of legal regulations to protect the family.*

**Keywords:** Justice, judicial system, statistics, judicial statistics.

## I- GİRİŞ

İstatistik, olayların ve olguların gözlemlenmesi yoluyla elde edilen tekniklerin tümünü belirli bir amaç için veri toplama, tablo ve grafiklerle özetleme, sonuçları yorumlama, sonuçların güven derecelerini açıklama, örneklerden elde edilen sonuçları kitle için genelleme, özellikler arasındaki ilişkiyi araştırma, çeşitli konularda geleceğe ilişkin tahmin yapma ve bilgi kirliliğinin önüne geçilerek ihtiyaç duyulan güvenilir bilginin oluşmasını sağlayan bir bilim dalı olarak çağımızın pusulası haline gelmiştir. Günümüzde bu pusulanın görevi; devletlere, araştırmacılara ve bilim insanlarına, dünü anlayıp bugünü yorumlama dolayısıyla geleceği inşa ederek bilgi toplumu olma yolunda rehberlik etmektedir<sup>3</sup>.

İstatistik ve bilgi toplumu arasındaki bu ilişki, adalet alanındaki gelişim ve değişimleri de istatistik perspektifiyle yakından takip etmeyi gerekli kılmıştır. Dijitalleşmenin insan hayatını tüm yönleriyle kuşattığı çağımızda; istatistik, disiplinler arası bir iletişim aracı ve objektif (nesnel) bir bilgi kaynağı olarak da değerlendirilmektedir. Bu bakımdan adalet istatistikleri, bu bilimin yargı alanına özgülmesiyle ortaya çıkmış ve özellikle son dönemde yargı politikalarının belirlenmesinde en önemli unsurlardan biri haline gelmiştir.

Hukuk sistemimizin işleyişi ile ilgili eksikliklerin ve aksaklıkların giderilip düzeltilmesi, ileriye yönelik plan ve programların yapılması, yeni projelerin üretilmesi sürecinde bu alanla ilgili olarak göstergelere ihtiyaç duyulacağı inkâr edilemez bir gerçektir. Bu göstergelerin hesaplanmasında kullanılan verilerin önemli bir kısmını adalet istatistiklerinde bulmak mümkündür.

## II- ADALET KAVRAMI VE ADALETTE İSTATİSTİĞE DUYULAN İHTİYAÇ: ADALET İSTATİSTİKLERİ

### A- Adalet Kavramı

Adalet terimi Arapça “adl” kelimesinden türemiştir. Adalet kelimesi sözlüklerde “hak ve hukuka uygunluk”, “herkese kendine uygun düşeni, kendi hakkı olanı verme”, “insaf etme”, “kanunlarla sahip olunan hakların herkes tarafından kullanılması”, “doğruluk”, “denge”, “eşitlik” gibi anlamlarda kullanılmaktadır<sup>4</sup>.

<sup>3</sup> **Adalet İstatistikleri** (Justice Statistics) 2022, TC. Adalet Bakanlığı Adli Sicil ve İstatistik Genel Müdürlüğü, Ankara **2022**, s. XVIII (*Adalet İstatistikleri- 2022*); **Adalet İstatistikleri** (Justice Statistics) **2023**, TC. Adalet Bakanlığı Adli Sicil ve İstatistik Genel Müdürlüğü, Ankara Mart 2024, s. XVIII (*Adalet İstatistikleri- 2023*).

<sup>4</sup> **Yılmaz, Ejder**, Adalet, İnsana Yakışan Davranış, Ankara 2020, s. 1; **Çağırıcı, Mustafa**, Adalet, TDV İslam Ansiklopedisi, C. 1, İstanbul 1988, s. 341 vd. TDK Sözlüğü'nde adalet teriminin karşılığı “1. Hak ve hukuka uygunluk, hakkı gözetme, 2. Yasalarla sahip olunan hakların herkes tarafından kullanılmasının sağlanması; türe. 3. Bu işi uygulayan, yerine getiren devlet kuruluşları, 4. Herkese kendine uygun düşeni, kendi hakkı olanı verme” olarak belirtilmiştir.



Hukuki terim olarak adalet nedir? Başka hiçbir soru, adalet terimi kadar tutkulu bir şekilde tartışılmamış; başka hiçbir soru böylesine çok kan ve gözyaşı dökülmesine sebep olmamış ve başka hiçbir soru Eflatun'dan Kant'a en ünlü düşünürlerin yoğun ilgisine konu olmamıştır. Ancak başka hiçbir soru bugün, diğer zamanlarda olmadığı kadar da cevapsız kalmamıştır. Öyle görünüyor ki bu soru, kaderine boyun eğmiş bilgeliğin uygulandığı ve insanın kesin bir cevap bulamayacağı, fakat ancak onu geliştirebileceği sorulardan biridir<sup>5</sup>.

Felsefeciler, özellikle hukuk felsefecileri, genelde hukukun en temel idesi olarak niteledikleri adaletin tanımlanmasının zor, hatta imkânsız olduğunu ifade etmişlerdir. Müslüman bilginler açısından ise adalet esas itibarıyla tanımlanabilir ve gerçekleştirilebilir bir şeydir. “Adalet nedir?” sorusuna, İslam bilginleri genel olarak “Adalet dengedir, orta noktadır” cevabını vermişlerdir<sup>6</sup>. Bu çerçevede, İslam bilginleri açısından aslolan adalettir ve hukuk esas itibarıyla adaletin aracıdır. Adaletin ne olduğu (mahiyet) esasında bellidir. Bu da bireysel ve toplumsal dengenin sağlanması, korunması ve sürdürülmesinden ibarettir. Ancak bu dengenin nasıl sağlanacağı (keyfiyet) konusunda zaman ve zemine göre kimi değişikliklerin olması elbette mümkündür<sup>7</sup>.

Modern hukuk açısından adalet ise, “insan ilişkilerini düzenleyen toplumsal kuralların içinde en ideal değer ölçüsü” olarak tanımlanmaktadır. Bu anlamda adaletin, herkesin hakkının gözetilmesi, hakkını alabilmesi, kimsenin başkasına zarar vermemesi yönündeki bir duygu olduğu söylenebilir<sup>8</sup>.

## B- Adalette İstatistiğe Duyulan İhtiyaç

İstatistiğin konusu olan olayları açıklayabilmek için bir olayın kendi türünden olayları, ilgilenilen özellikler bakımından tam olarak temsil edip etmediğine, başka bir ifadeyle olayların ilgilenilen özelliklerinin ölçüm değerleri arasında değişkenlik ve belirsizlik olup olmadığına bakmak gerekir. Olayların özellikleriyle ilgili ölçüm değerlerindeki değişkenlik ölçüt alındığında ise, olaylar yığın olay ve tipik olay olarak sınıflandırılmaktadır<sup>9</sup>.

İstatistik yığın olaylarla ilgilenir. Bu olaylar ilgilenilen özellikleri bakımından değişkenlik ve belirsizlik gösterirler. Aynı koşullar ve varsayımlar altında meydana gelen, özellikleri aynı sonuçların (ölçüm değerlerinin) yanında farklı sonuçları da alabilen olaylara **yığın olay** denir. Yığın olayların incelenen özellikleri olaydan olaya değişkenlik gösterdiği için herhangi bir yığın olay ait olduğu kümedeki olayları tam olarak temsil edemez. Buna karşılık, aynı şartlar ve varsayımlar altında meydana gelen, incelenen özellikleri bakımından aynı sonuçları alan olaylara **tipik olay** adı verilmektedir<sup>10</sup>. Tipik olayların ilgilenilen özellikleri tek bir ölçüm değerine sahiptir. Bu olayların özellikleri değişkenlik göstermez ve bu nedenle herhangi bir tipik olay ait olduğu olaylar kümesindeki bütün olayları tam olarak açıklar. İstatistik tipik olaylarla ilgilenmez. Ayrıca istatistik tek bir olayın bir özelliğinin alacağı bir ölçüm değeri ile de ilgilenmez<sup>11</sup>. Örneğin; adalet istatistikleri bakımından, bir yıl içerisinde Tokat'ta meydana gelen adam öldürme fiillerinden her biri, yığın olaydır.

Tarih boyunca toplumların, devletlerin istatistiğe duydukları gereksinime paralel olarak geliştirilmiş olan çeşitli tanımların üzerinde durmak yerine, genellikle istatistik kavramının yaygın olarak kullanılan

<sup>5</sup> **Kelsen, Hans**, Adalet Nedir (What is Justice?) (Çev. Acar, Ali), TBB Dergisi 2013 (107), s. 431- 432.

<sup>6</sup> **Apaydın, H.Yunus**, Adalet Nedir?, Mahiyet ve Keyfiyet, Bilimname: Düşünce Platformu XXXIV, 2018/1 CC BY-NC-ND 4.0 (s. 459- 476), s. 459.

<sup>7</sup> **Apaydın**, s. 473.

<sup>8</sup> **Tuncay, Can**, Adalet Nedir? Bahçeşehir Üniv. HFD, C. 13, Sa. 171 (s. 199-238), Kasım-Aralık 2018, s. 199.

<sup>9</sup> **Özmen, Ahmet/ Er, Fikret/Atlas, Mahmut/ Aslanargun, Atilla/ Peker, Özgür/ Şıklar, Emel/ Sönmez, Harun**, (Ünite yazarı: Özmen), İstatistik, T.C. Anadolu Üniversitesi Yayını No: 2590, 2012, Eskişehir, s. 3.

<sup>10</sup> **Özmen/ Er/Atlas/ Aslanargun/ Peker/ Şıklar/ Sönmez** (Ünite yazarı: Özmen), s. 3.

<sup>11</sup> **Özmen/ Er/Atlas/ Aslanargun/ Peker/ Şıklar/ Sönmez** (Ünite yazarı: Özmen), s. 5.



**V. International Applied Statistics Congress (UYİK - 2024)**  
**İstanbul / Türkiye, May 21-23, 2024**

üç farklı anlamı üzerinde durulmuştur. Bunlar; **a)** Veri kümesi anlamında istatistik, **b)** Yöntemler topluluğu-bilim dalı anlamında istatistik, **c)** Örneklem değer anlamında istatistiktir.

Tanımlanan belirli bir konuda belirli amaç için yığın olayların çeşitli özellikleriyle ilgili olarak derlenmiş olan ve bir anlam ifade eden rakam, sayı, simgelere veri; verilerin oluşturduğu topluluğa veri kümesi veya istatistik adı verilmektedir. Veri kümesi anlamında istatistik kelimesi, daha çok kamu kurum ve kuruluşları olmak üzere her türlü kuruluş tarafından kendi görevleri, amaçları ve toplumun faydalanması için çeşitli konularda derlenen veriler kümesi anlamında kullanılmaktadır<sup>12</sup>. Bu tanım ışığında adalet istatistiklerinin bir kamu kuruluşu niteliğinde olan Adli Sicil ve İstatistik Genel Müdürlüğü tarafindan çıkarılması ve yayınlanması, bu istatistiklerin veri kümesi anlamında istatistik niteliğini göstermektedir.

Adalet istatistikleri, özellikle devletin adli / idari vakalar karşısında ne gibi tedbirler alacağını somutlaşması bakımından önem kazanmaktadır. Örneğin bilişim yoluyla hırsızlık veya dolandırıcılık suçlarının veya suç işleme yöntemlerinin sayısal olarak artması, hükümetleri/ devletleri bu konuda yasal düzenleme yapmaya sevk edecektir. Bu suretle kişilerin mağduriyetlerinin giderilmesine katkıda bulunulacaktır. Aynı şekilde boşanma davalarının artması durumunda, ailenin korunmasına ilişkin tedbirlerin de artırılması ve devletin aileyi koruyucu her türlü yasal düzenlemeyi yapması kaçınılmaz olacaktır.

Adalet istatistiklerinin yanısıra ülkemizde, ceza infaz kurumu istatistikleri<sup>13</sup>; güvenlik birimine gelen veya getirilen çocuk istatistikleri<sup>14</sup>, kolluk istatistikleri<sup>15</sup> ve seçim istatistikleri<sup>16</sup> de bulunmaktadır<sup>17</sup>. Çalışmamızda bu istatistiklere ayrıntılı olarak girilmemiştir.

<sup>12</sup> **Özmen/ Er/Atlas/ Aslanargun/ Peker/ Şıklar/ Sönmez** (Ünite yazarı: Özmen), s. 6.

<sup>13</sup> Ceza infaz kurumu istatistikleri işlediği suç veya suçlardan dolayı, mahkeme tarafından haklarında hürriyeti bağlayıcı ceza (hapis cezası) verilerek ceza infaz kurumlarına giren ve ceza infaz kurumlarından çıkan hükümlülere ait bilgiler kapsamaktadır. Adalet Bakanlığına bağlı il ve ilçelerdeki tüm ceza infaz kurumları ve eğitimevleri coğrafi kapsamı oluşturmaktadır. Ceza İnfaz Kurumu İstatistiklerinin veri kaynağı 2009 yılından itibaren Ulusal Yargı Ağı Bilişim Sistemidir (UYAP). Ceza İnfaz Kurumu İstatistikleri 2022 yılından itibaren Adalet Bakanlığı tarafından yayımlanmaya devam edilecektir. Ceza İnfaz Kurumu İstatistikleri, 2022 yılı itibarıyla Adalet Bakanlığı Adli Sicil ve İstatistik Genel Müdürlüğü tarafından Haber Bülteni şeklinde yıllık olarak yayımlanmaya başlamıştır. 2022 Bülteni için bkz.

<https://adlisicil.adalet.gov.tr/Resimler/SayfaDokuman/2062023110333Haber%20B%20C3%BCIteni%202022.pdf> (E.T. 15.09.2023).

<sup>14</sup> Güvenlik birimine gelen veya getirilen çocuk istatistikleri, polise ve jandarmaya bağlı güvenlik birimine gelen veya getirilen çocuklarla ilgili bilgilerden oluşmaktadır. Güvenlik Birimine Gelen veya Getirilen Çocuk İstatistikleri, polise ve jandarmaya bağlı güvenlik birimlerince yıllık olarak derlenmekte ve TÜİK tarafından yayımlanmaktadır.

<sup>15</sup> Kolluk istatistikleri, Emniyet Genel Müdürlüğü (EGM), Jandarma Genel Komutanlığı (JnGK), Sahil Güvenlik Komutanlığı, Ticaret Bakanlığının (TB) sorumluluk bölgelerinde meydana gelen suç olayları ile bu olaylardaki suç, şüpheli ve mağdurlara ilişkin bilgileri kapsamaktadır.

<sup>16</sup> Seçim istatistikleri milletvekili genel seçimi, mahalli idari seçimi, cumhurbaşkanlığı seçimi ve halk oylaması sonuçları ile bu seçimlere ait seçmen ve aday/kazanan aday profiline ilişkin bilgileri kapsamaktadır. Seçim İstatistikleri idari kayıtlara dayalı bilgiler olup, Yüksek Seçim Kurulu (YSK) Başkanlığı il ve ilçe seçim kurulları tarafından, seçim sonucuna göre tanımlanmış birleştirme tutanaklarından elde edilmektedir. Seçimlere ve halk oylaması sonuçlarına ait seçim çevresi ve sandık düzeyindeki bilgiler ile seçmen bilgileri, aday ve kazanan aday profiline (medeni durum, cinsiyet, yaş, eğitim durumu) ait bilgiler, TÜİK tarafından elektronik ortamda yayımlanmaktadır.

<sup>17</sup> Geniş açıklamalar için bkz. <https://www.resmiiistatistik.gov.tr/detail/subject/suc-adalet-ve-secim-istatistikleri/> (E.T. 5.09.2023).

### III- ADALET İSTATİSTİKLERİNİN TARİHİ SÜRECİ<sup>18</sup>

Adalet istatistikleri (adli istatistik verileri), eskiden Adalet Bakanlığı Ceza İşleri Genel Müdürlüğüne bağlı şube müdürlüğü tarafından derlenmekte idi. Daha sonra bu görev 1979 yılında kurulan Adli Sicil ve İstatistik Genel Müdürlüğüne verilmiş ve ilk kez 1982 yılında adalet istatistikleri yılı kapsamında yayımlanmıştır.

1986 yılında Devlet İstatistik Enstitüsü ile veri alışverişi konusunda mutabakata varılmış ve her yıl Adli Sicil ve İstatistik Genel Müdürlüğü tarafından mahkemeler, Cumhuriyet başsavcılıkları ve icra müdürlüklerinden derlenen ve yayımlanan veriler ayrıca Enstitüye iletilmiştir.

5429 sayılı Türkiye İstatistik Kanunu'na dayanılarak hazırlanan ve 30.12.2006 tarih ve 26392 sayılı Resmi Gazete'de yayımlanarak yürürlüğe giren 2007-2011 Resmi İstatistik Programı (RİP) gereği Türkiye İstatistik Kurumu (TÜİK) tarafından yayımlanmakta olan "Adalet İstatistikleri" yayınına ait veri derleme ve yayımlama sorumluluğu, Adalet Bakanlığı Adli Sicil ve İstatistik Genel Müdürlüğüne verilmiştir.

Bu kapsamda; 31.12.2021 tarih ve 31706 (5. Mükerrer) sayılı Resmi Gazete'de yayımlanarak yürürlüğe giren 2022-2026 Resmi İstatistik Programı (RİP) gereği 2022 yılı "Adalet İstatistikleri" yayını, Adli Sicil ve İstatistik Genel Müdürlüğü tarafından hazırlanmıştır.

Bununla birlikte; adalet istatistiklerini toplamak, sınıflandırmak ve gerektiğinde analizini yaparak elde edilecek sonuçları gerekli tedbirlerin alınması amacıyla ilgili kurum ve kuruluşlarla paylaşmak, istatistik üretim metodlarını ve buna ilişkin teknik altyapıyı geliştirmek, adalet istatistiklerinin değerlendirilmesini yapmak üzere ihtiyaç halinde çalışma grupları ve/veya bilim komisyonları oluşturmak, eğitim programları düzenlemek, adalet istatistiklerine ilişkin ulusal ve uluslararası kongre, sempozyum ve panel gibi etkinlikler düzenlemek üzere Adli Sicil ve İstatistik Genel Müdürlüğü bünyesinde 01.12.2022 tarihli Bakan Olur'uyla Adalet İstatistiklerini Derleme ve Değerlendirme Daire Başkanlığı kurulmuştur. Geçmiş yıllarda teşkilattan formlarla toplanan verilerle sınırlı sayıda üretilen istatistiklerle yayımlar hazırlanırken; Adalet Bakanlığınca yapılan bilişim ve teknolojik alt yapı geliştirme çalışmaları neticesinde kurulan Adli Veri Bankasından üretilen istatistiklerle, farklılaşan ve artan bilgi talepleri doğrultusunda 2022 yılı yayının içeriği genişletilmiştir.

Ayrıca belirtmek gerekir ki, tarihi süreç içerisinde, ülkemizde istatistik alanındaki teknolojik gelişmelere paralel şekilde ve bilişim alt yapı geliştirilme çalışmalarına önem verilerek Genel Müdürlük bünyesinde "Adli Veri Bankası" kurulması da oldukça önemlidir. Adli Veri Bankasından üretilen istatistikler sayesinde adalet mekanizmasının işleyişi ile ilgili olarak ileriye dönük daha isabetli plân ve programlar yapılması ve doğru adalet politikalarının geliştirilmesi de önemlidir<sup>19</sup>.

### IV- ADALET İSTATİSTİKLERİNİN AMACI VE KAPSAMI

#### A- Adalet İstatistiklerinin Amacı

Öncelikle belirtmek gerekir ki ulusal istatistik sistemlerinin amacı; kullanıcı ihtiyaçlarını dikkate alarak, ulusal ve uluslararası standartlara uygun, doğru ve güvenilir istatistikler üretilmesini sağlamaktır. Bu doğrultuda resmi istatistikler için kalite ilke ve standartlarının belirlenmesine ihtiyaç duyulmuştur. Bu ilkelerin ise temel amacı, üretilen istatistiklere olan güveni sağlamak ve politika yapıcılara hizmet etmektir. Bu güven, veri üretiminde kullanılan istatistiksel yöntemlerin şeffaflığı ve verilerin kalitesi üzerine kurulur<sup>20</sup>.

<sup>18</sup> Adalet İstatistikleri- 2022, s. XVIII- XIX; Adalet İstatistikleri- 2023, s. XVIII- XIX.

<sup>19</sup> Adalet İstatistikleri-2022, s. V; Adalet İstatistikleri-2023, s. XIX.

<sup>20</sup> <https://www.resmiistatistik.gov.tr/detail/resmi-istatistik-ilkeleri> (E.T. 27.08.2023).



**V. International Applied Statistics Congress (UYİK - 2024)**  
**İstanbul / Türkiye, May 21-23, 2024**

Adalet istatistiklerinin amacına gelince, bu amacı aşağıdaki başlıklar altında ele almak mümkündür<sup>21</sup>:

- Uluslararası standartlarda istatistik üretmek ve işlemek,
- Yargıdaki davaların seyrini, suç ve suçluluk hareketlerini ve ülke genelindeki dağılımını izlemek<sup>22</sup>,
- Yargıda etkinliği<sup>23</sup> artırmak<sup>24</sup>;
- Karar alıcıların, araştırmacıların ve diğer ulusal ve uluslararası kullanıcıların beklentilerini karşılayacak biçimde tarafsız olarak adli istatistik sunmak,
- Elde edilen bu bilgilerden politikaların oluşturulmasına katkı sağlamaktır.

Burada adalet istatistiklerinin özellikle “elde edilen bu bilgilerden politikaların oluşturulmasına katkı sağlamak” amacı oldukça önemlidir. Zira bu istatistiki bilgiler sayesinde Türkiye’de yargı paketleri ve yargı reformları gerçekleştirilmekte; toplumun beklentilerine bu suretle cevap verilebilmektedir.

Örneğin; kadına karşı şiddet nedeniyle açılan boşanma davalarının eski yıllara göre oldukça arttığı istatistiklere yansıtıldığında, bu konuda hükümetlerin tedbir almaları, şiddeti ağır bir şekilde cezalandıran düzenlemeleri getirmeleri ve ayrıca şiddet mağdurlarını koruyacak düzenlemeleri yapma konusunda adım atmaları kaçınılmazdır. Bu nedenle adli istatistiklerin bir anlamda toplumun beklentilerinin yasal düzenlemelere yansımada önemli bir işlev gördüğünü belirtmek yanlış olmayacaktır.

Özetle; adalet teşkilâtının hafıza kartı olarak kabul edilen adalet istatistikleri geçmişteki verileri değerlendirerek adli sistemin güncel durumunu analiz etmekte ve geleceğe ışık tutmaktadır. Adalet istatistikleri davaların seyri, suç ve suçluluk hareketleri ile adli olayların ülke genelindeki dağılımının görülmesi, yargı sisteminin uluslararası yargı sistemleriyle karşılaştırılabilmesi, mevzuat etki analizleri yapılarak ihtiyaç duyulan mevzuatların hazırlanmasında kullanılmakta ve böylece yargı politikaları oluşturulabilmektedir<sup>25</sup>. Bir başka deyişle adalet istatistikleri; hukuk ve adalet sistemimizde yer alan sayısal verilerin yorumlanarak ileriye dönük tahminlerin yapılması ve bu hususta sistemin ilerleyişine dair politikaların belirlenmesi çerçevesinde karar alıcılar için rehber niteliği taşımaktadır<sup>26</sup>.

<sup>21</sup> <https://adlisicil.adalet.gov.tr/Home/SayfaDetay/adli-istatistik-calismalari> (E.T. 27.08.2023).

<sup>22</sup> Örneğin bir haberde şu ifadeler yer verilmiştir: “Adalet Bakanlığı'nın 2021 yılına ilişkin adli istatistikleri, Türkiye’de suç oranlarında artış yaşandığını gözler önüne serdi. Özellikle hırsızlık, dolandırıcılık ve yağma gibi suçları kapsayan malvarlığına karşı işlenen suçlar, Türkiye’de en fazla işlenen suç grubu oldu. Geçen yıl bu suçlardan 2 milyon 461 bin dosya açıldı. Tüm suç grupları içinde uyuşturucu suçunun oranı yüzde 5’e yükselirken, açılan dosya sayısı geçen yıl 422 bine çıktı. 2021’de 127 bine yükselen cinsel dokunulmazlığa karşı işlenen suçlarda ilk sırayı 44 bin rakamıyla “çocukların cinsel istismarı” aldı”. (<https://t24.com.tr/haber/Türkiye-de-suc-oranlari-artiyor,1057612>; ET. 27.08.2023).

<sup>23</sup> Yargıya ilişkin kapsamlı bir değerlendirme yapabilmek ve sistemin gerçekte nasıl işlediğini anlayabilmek, aynı zamanda verimlilik, etkinlik ve niteliğe ilişkin veri ve gözlemlerin de dikkate alınmasını gerektirir (Bkz. **Çelik, Demirhan Burak**, Türkiye’de Yargının Verimliliği, Etkinliği ve Niteliği Üzerine Kimi Gözlemler, Finans Politik & Ekonomik Yorumlar 2015 Cilt: 52 Sayı: 610 s. 77).

<sup>24</sup> Ayrıca bir hususu vurgulamak gerekir ki, Avrupa Adaletinin Etkinliği Komisyonu (CEPEJ), Avrupa Konseyi Bakanlar Komitesi’nin 18 Eylül 2002 tarih ve 2002/12 sayılı kararı ile kurulmuş uluslararası bir kuruluştur. CEPEJ’in kuruluş amacı üye devletlerde yargının etkinliğini ve işleyişini iyileştirmek ve Avrupa Konseyi tarafından bu amaçla hazırlanmış olan sistemlerin uygulamasını geliştirmektir. CEPEJ’in görevlerinden birisi de “genel istatistiki kriterleri ve değerlendirme araçlarını kullanarak, farklı adli sistemler tarafından ulaşılan sonuçları gözden geçirmek” olarak belirtilmiştir (<https://www.hsk.gov.tr/cepej>). Ayrıca bkz. **Özcelik, Zübeyir**, Yargılama Sürelerinin İyileştirilmesi Bağlamında Nicel Verilere Dayalı Performans Değerlemesi İçin Bir Model Önerisi, Ankara Hacı Bayram Veli Üniversitesi İktisadi ve İdari Bilimler Fakültesi Dergisi 24/2 (2022) (847-856), s. 848.

<sup>25</sup> Adalet İstatistikleri- 2022, s. V; Adalet İstatistikleri- 2023, s. V.

<sup>26</sup> Adalet İstatistikleri- 2022, s. V; Adalet İstatistikleri- 2023, s. V.



## B- Adalet İstatistiklerinin Kapsamı

Adalet istatistikleri, Türkiye genelinde tüm il ve ilçelerdeki ilk derece mahkemeler, Cumhuriyet başsavcılıkları, idari mahkemeler, icra müdürlükleri, Bölge Adliye Mahkemeleri, Bölge İdare Mahkemeleri, Anayasa Mahkemesi, Yargıtay Başkanlığı, Danıştay Başkanlığı, Uyuşmazlık Mahkemesi, Yüksek Hakem Kurulu, Türkiye Noterler Birliği, Türkiye Barolar Birliği, Adli Tıp Kurumu, Ceza İşleri Genel Müdürlüğü Alternatif Çözümler Daire Başkanlığı, Hukuk İşleri Genel Müdürlüğü Arabuluculuk Daire Başkanlığı'na ait istatistiki verilerden oluşmaktadır<sup>27</sup>.

İstatistiklerin içeriğine gelince;

- Adalet istatistiklerine bakıldığında; özellikle “**adalet sistemi**” başlığında yüksek mahkemelerin (Danıştay, Yargıtay gibi) ve adli- idari yargıdaki mahkemelerin iş durumları, bir dosyanın ortalama görülme süresi, ceza mahkemelerinde seçilen on suç türüne göre yıl içinde açılan dosya endeksi, hukuk mahkemelerinde seçilen on dava türüne göre yıl içinde açılan dosya endeksi, adalet teşkilâtı hâkim ve savcı sayıları ele alınmaktadır.
- “**Tarihi tablolar**” başlığında; adalet sistemi evrelerine ilişkin *temizleme oranı*<sup>28</sup>, Adalet sistemi evrelerine ilişkin bir dosyanın ortalama görülme süresi, devreden dosyaların elden çıkarılma süresi, yıl içinde açılan dosya endeksi; Cumhuriyet başsavcılıklarında seçilen on suç türüne göre temizleme oranı, Cumhuriyet başsavcılıklarında seçilen on suç türüne göre bir dosyanın ortalama görülme süresi, Cumhuriyet başsavcılıklarında daimi arama kararı verilen dosyalardan arındırılmış seçilen on suç türüne göre bir dosyanın ortalama görülme süresi, Cumhuriyet başsavcılıklarında seçilen on suç türüne göre yıl içinde açılan dosya endeksi, Cumhuriyet başsavcılıklarında ihbar dosya ve soruşturma dosya sayıları, mağdur/ müşteki ve şüpheli sayıları, ceza mahkemelerinde seçilen on suç türüne göre çıkan dosyaların gelen dosyalara oranı, hukuk mahkeme türüne göre bir dosyanın ortalama görülme süresi ve temizleme oranları, Yüksek Mahkemeler, idare, vergi ve Bölge İdare, Bölge Adliye Mahkemeleri ve icra ve iflas daireleri ile ilgili benzer birçok veri yer almaktadır<sup>29</sup>.

## V- ADALET İSTATİSTİKLERİNİN HAZIRLANMASINDAKİ TEMEL İLKELER <sup>30</sup>

### 1- Kalite

Genel açıdan kalite, bir ürün, hizmet, süreç veya oluşumdan beklenen ihtiyaçları karşılayabilme, hizmet verdiği kişi ya da kişilere en iyiyi sağlayabilme yeteneği olarak tanımlanabilir. Bir başka deyişle kalite, bir ürün veya hizmetin belirlenen veya olabilecek ihtiyaçları karşılama kabiliyetine dayanan özelliklerin toplamı olarak anlaşılabilir<sup>31</sup>. Bir ülkenin kalkınmışlık düzeyinin en inandırıcı delili, ürettiği mal veya hizmetin kalitesidir. Bu anlamda kalite, amaca uygunluk ve kullanımda güvenlik şeklinde de tanımlanabilir<sup>32</sup>.

<sup>27</sup> Adalet İstatistikleri- 2022, s. VIII- XVIII; Adalet İstatistikleri- 2023, s. XIX.

<sup>28</sup> Temizleme oranı, adli birimde yıl içinde karara bağlanan dosyaların, yıl içinde yeni gelen dosyalara oranını gösterir. Yıl içinde çıkan dosyalar savcılıklarda ve mahkemelerde sonuçlandırılan, karara bağlanan ve başka birime aktarılarak çıkarılan dosyaları ifade eder. Yıl içinde karara bağlanan dosyalar içinde referans yılda açılıp yine aynı yıl içinde çıkan dosyalar olduğu gibi geçmiş yıllarda açılmış ancak referans yılda çıkarılan dosyalar da mevcuttur  
([https://adlisicil.adalet.gov.tr/Resimler/SayfaDokuman/29032023095741ASIGM%20Me\\_taveri.pdf](https://adlisicil.adalet.gov.tr/Resimler/SayfaDokuman/29032023095741ASIGM%20Me_taveri.pdf)); E.T. 15.09.2023.

<sup>29</sup> Adalet İstatistikleri 2022, s. XIX.

<sup>30</sup> <https://adlisicil.adalet.gov.tr/Home/SayfaDetay/adli-istatistik-calismalari> (E.T. 27.08.2023).

<sup>31</sup> **Altınöz, İsmail**, Kalite Yolculuğu, Arşiv Dünyası, Ocak 2005, Sayı: 5, s. 21.

<sup>32</sup> **Altınöz**, s. 22.

İşte adalet istatistikleri hazırlanırken amaca uygun ve kullanımda güvenlik şeklinde özetlenebilecek kalite kavramı önem kazanmaktadır.

Bu anlamda istatistiki verinin kalitesinin, istatistiksel teknikler kullanılarak düzenli olarak kontrol edilmesi ve raporlanması oldukça önemlidir. Ayrıca süreç ve çıktı kalitesini sürekli olarak iyileştirmek amacıyla düzenli ve sistematik olarak güçlü ve zayıf yönlerin tespit edilmesi de önem arz etmektedir<sup>33</sup>.

## 2- Güvenilirlik

İstatistiklerin toplanması, işlenmesi ve dağıtılması süreçlerinde uluslararası standartlar, kılavuzlar ve iyi uygulamaların takip edilmesi gerekir. Standart tanımlar, kavramlar ve sınıflamaların kullanılması kaliteli istatistiklerin temelini oluşturur. Bu husus istatistik üretiminde uygun araçların, usullerin ve uzmanlığın kullanılmasını gerektirir<sup>34</sup>.

## 3- Zamanlılık

Üretilen istatistiklerin yayımlama zamanı önceden belirlenerek duyurulmalı ve Ulusal Veri Yayımlama Takvimi (UVYT)<sup>35</sup> ile uyumlu olarak yayımlanmalıdır<sup>36</sup>.

Kanımızca zamanlılık ilkesinin bir diğer anlamı, istatistik üretiminin belli bir süre ve periyot ile sınırlı olmasıdır. Bu anlamda adalet istatistiklerinin her yıl hazırlanması bu ilkenin bir gereği olarak düşünülebilir.

## 4- Güncellik

Güncel terimi “günün konusu olan, şimdiki, bugünkü (haber, olay vb.); gündeş, aktüel” anlamına gelir. Güncellik ise “güncel olma durumu; aktüellik, aktüalite” demektir<sup>37</sup> Adalet istatistikleri bakımından en önemli ilkelerden biri de istatistiklerin günün konusu olan (güncel) olayların irdelenip bunların dikkate alınmasıdır.

Örneğin, bilişim suçları internetin olmadığı zaman istatistiki veriler içinde yer almıyordu. Buna karşılık günümüzde hızla gelişen internet ve teknoloji çağında bilişim suçları da artık adalet istatistiklerinde ve özellikle suç istatistiklerinde yer almaktadır. Nitekim 2022 tarihli Adalet İstatistiklerinde “Bilişim alanında suçlar (TCK Madde 243-246) başlığı altında, bilişim sistemine girme, sistemi engelleme, bozma, verileri yok etme veya değiştirme, banka veya kredi kartlarının kötüye kullanılması, yasak cihaz veya programlar, tüzel kişiler hakkında güvenlik tedbiri uygulanması alt başlıklarında yer almıştır<sup>38</sup>.

<sup>33</sup> <https://www.resmiistatistik.gov.tr/detail/resmi-istatistik-ilkeleri> (ET. 30.08.2023).

<sup>34</sup> <https://www.resmiistatistik.gov.tr/detail/resmi-istatistik-ilkeleri> (ET. 30.08.2023).

<sup>35</sup> Ulusal Veri Yayımlama Takvimi; 5429 sayılı Türkiye İstatistik Kanunu'na dayanılarak çıkarılan Resmi İstatistik Programı kapsamındaki tüm kurum ve kuruluşların yayımlayacakları verileri zamanlı ve daha etkin bir şekilde kullanıcılara sunabilmeleri amacıyla Türkiye İstatistik Kurumu koordinasyonunda hazırlanmakta ve 2007 yılından itibaren her yıl düzenli olarak güncellenmekte ve yılın ilk günü yayımlanmaktadır. Ulusal Veri Yayımlama Takvimi ile üretilen resmi istatistiklerin yayımlanacağı tarih ve saatler önceden ilan edilmekte, böylece karar alıcıların ve kullanıcıların resmi istatistiklerden zamanlı olarak haberdar olması sağlanmaktadır. Türkiye İstatistik Kurumunun da dahil olduğu bütün kamu kurum ve kuruluşları tarafından 2022 yılında açıklanacak resmi istatistiklerin yayımlanma zamanını gösteren “2022 Yılı Ulusal Veri Yayımlama Takvimi” TÜİK internet sayfasında [www.tuik.gov.tr](http://www.tuik.gov.tr) ve Resmi İstatistik Portalında [www.resmiistatistik.gov.tr](http://www.resmiistatistik.gov.tr) adresinde kullanıma sunulmuştur (<https://www.resmiistatistik.gov.tr/detail/news/2022-yili-ulusal-veri-yayimlama-takvimi-aciklandi>).

<sup>36</sup> <https://www.resmiistatistik.gov.tr/detail/resmi-istatistik-ilkeleri> (ET. 30.08.2023).

<sup>37</sup> <https://sozluk.gov.tr> (ET. 28.08.2023).

<sup>38</sup> Adalet İstatistikleri 2022, s. XLIV.

## 5- Meslekî Uzmanlık

Resmi istatistiklerin toplanması, işlenmesi ve dağıtılması süreçlerinde uluslararası standartlar, kılavuzlar ve iyi uygulamalar takip edilmelidir. Standart tanımlar, kavramlar ve sınıflamaların kullanılması kaliteli istatistiklerin temelini oluşturur. Bu husus istatistik üretiminde uygun araçların, usullerin ve *uzmanlığın* kullanılmasını gerektirir<sup>39</sup>. Adalet sicilleri bakımından da aynı husus söylenebilir.

## 6- Tarafsızlık ve Şeffaflık

İstatistik üreten kurum ya da kuruluşların, verilerini, bilimsel bağımsızlık ilkesi çerçevesinde ve tüm kullanıcılara eşit mesafede, tarafsız, profesyonel ve şeffaf bir biçimde üretmesi ve dağıtması gerekir. Veri üreticilerinin üretecekleri adalet istatistiklerinin amaç ve hedefini net olarak tanımlaması, istatistik üretiminde kullanılan veri kaynaklarını, yöntemleri, önemli revizyonları, istatistiklerin yayımlanma tarihlerini, yayımlanmış istatistiklerde fark edilen hataları kamuoyuna duyurmaları oldukça önem arz etmektedir<sup>40</sup>.

## 7- Kişisel Verilerde Gizlilik

Resmi istatistik üreten kurum ve kuruluşlar (konumuzla ilgili olarak, Adli Sicil ve İstatistik Genel Müdürlüğü) gizli verilerin hukuka aykırı erişimine, açıklanmasına veya kullanımına karşı her türlü önlemi almak zorundadır. Resmi istatistiklerin (adalet istatistiklerinin) üretilmesi için toplanan, işlenen ve saklanan verilerden gizli olanlar, idari, adli ve askeri hiçbir organ, makam, merci veya kişiye verilemez, istatistik amacı dışında kullanılamaz ve ispat aracı olamaz. Söz konusu bilgilerin yalnızca istatistiksel amaçlar için kullanımı ve verilerin güvenliği garanti edilmelidir<sup>41</sup>.

5429 Sayılı Türkiye İstatistik Kanunu<sup>42</sup> ile tanımlanan gizlilik kuralları, Resmi İstatistik Programı (RİP) kapsamında istatistik üretim sürecinde yer alan tüm kurum/kuruluşlar ile bunların ihale yoluyla iş yaptırdığı özel sektör yüklenici firmaları için de geçerlidir. Aracı şirketlerce yürütülen araştırmalar için, gizlilik hükümleri gereğince kurum/kuruluşlara iletilecek veri ve bilgilerin korunması ve saklanmasında gizlilik ilkesi bağlayıcı olmaktadır. Buna göre aracı firmalar elde ettikleri hiçbir bilgiyi üçüncü şahıslarla paylaşamazlar<sup>43</sup>.

Bu anlamda 5429 Sayılı Türkiye İstatistik Kanunu'nun 13. maddesinin gizli veriler başlıklı hükmü şu şekildedir:

*“Gizli verilere yalnızca resmî istatistik üretiminde görev alanlar, görevlerini yerine getirebilmek için ihtiyaç duydukları ölçüde erişebilirler.*

*Bireysel verinin toplulaştırılması ile oluşturulan veri tablosunun herhangi bir hücresindeki istatistikî birim sayısının üçten az olması veya birim sayısı üç ve daha fazla olduğu hâlde bir veya iki istatistikî birimin hakim durumda olması hâlinde ilgili hücredeki veri gizli kabul edilir.*

*Resmî istatistiklerin üretilmesi için toplanan, işlenen ve saklanan verilerden gizli olanları, idarî, adli ve askerî hiçbir organ, makam, merci veya kişiye verilemez, istatistik amacı dışında kullanılamaz ve ispat aracı olamaz. Bu bilgileri derleyen ve değerlendiren memurlar ve diğer görevliler de bu yasağa uymak zorundadır. Bu yükümlülük, görevlilerin görevlerinden ayrılmalarından sonra da devam eder. Resmî istatistik üreten kurum ve kuruluşların yetkilileri tarafından, gizli verilerin hukuka aykırı erişimine, açıklanmasına veya kullanımına karşı her türlü önlem alınır.*

*Herkes açık kaynaklardan elde edilen veri veya bilgiler gizli kabul edilmez.*

<sup>39</sup> <https://www.resmiistatistik.gov.tr/detail/resmi-istatistik-ilkeleri> (ET. 30.08.2023).

<sup>40</sup> Genel olarak resmi istatistikler için bkz. ve karşı. <https://www.resmiistatistik.gov.tr/detail/resmi-istatistik-ilkeleri> (ET. 30.08.2023).

<sup>41</sup> <https://www.resmiistatistik.gov.tr/detail/resmi-istatistik-ilkeleri> (ET. 30.08.2023).

<sup>42</sup> RG. 18.11.2005, Sa: 25997.

<sup>43</sup> <https://www.resmiistatistik.gov.tr/detail/resmi-istatistik-ilkeleri> (ET. 30.08.2023).



*İstatistikî birimin, kendisine ait gizli verilerin açıklanmasına yazılı onay vermesi hâlinde, veri gizliliği ortadan kalkar.*

*Gizli veriler, ancak doğrudan veya dolaylı tanımlamaya yol açmayacak şekilde diğer bilgilerle birleştirilerek yayımlanabilir.*

*(Ek fıkra: 25/11/2008-5813/2 md.) Dış ticaret istatistiklerinde dolaylı tanınma ile gizlilik kapsamına giren veriler için bu gizlilik hükümleri, istatistikî birimin kendisine ait verinin gizlenmesini talep eden yazılı başvurusu halinde uygulanır.*

*Veri gizliliği ve güvenliğine ilişkin usûl ve esaslar, ulusal ve uluslararası ilkeler doğrultusunda, ilgili kurum ve kuruluşların görüşleri alınarak çıkarılacak yönetmelikle düzenlenir”.*

İstatistikî gizlilik ilkesi doğrultusunda, veri gizliliği ve güvenliğine ilişkin usul ve esaslar “Resmî İstatistiklerde Veri Gizliliği ve Gizli Veri Güvenliğine İlişkin Usul ve Esaslar Hakkında Yönetmelik”<sup>44</sup> ile düzenlenmiştir<sup>45</sup>.

Burada Yönetmeliğin “Gizli verinin korunması” başlıklı 7 inci maddesinde, “Kurumların/kuruluşların yetkilileri, Programda belirtilen resmî istatistik çalışmalarının, gizli verilerin açıklanmasına imkân vermeyecek şekilde yürütülmesini sağlar, bu verilerin istatistikî amaç dışında kullanılmaması için her türlü önlemi alır ve istatistik üretiminin her aşamasındaki gizli verinin bulunduğu ortama yetkisiz kimselerin fiziksel veya elektronik yollarla erişiminin engellenmesi için gerek duyulan güvenlik sistemlerini belirler ve kullanır” hükmü öngörülmüştür. Şu halde bu hüküm gereğince, Adli Sicil ve İstatistik Genel Müdürlüğü’nün, resmî istatistik çalışmalarının gizli verilerin açıklanmasına imkân vermeyecek şekilde yürütülmesini sağlama, bu verilerin istatistikî amaç dışında kullanılmaması için her türlü önlemi alma gibi yükümlülüğünün bulunduğu söylenebilecektir. Genel Müdürlük ayrıca istatistik üretiminin her aşamasındaki gizli verinin bulunduğu ortama yetkisiz kimselerin fiziksel veya elektronik yollarla erişiminin engellenmesi için gerek duyulan güvenlik sistemlerini belirleyecek ve kullanacaktır.

## **8- Veri Sağlayıcılarına ve Kullanıcılarına Odaklılık**

Kullanıcılara ihtiyaçlarını karşılayan ürünler ve hizmetler sağlanır. İç ve dış kullanıcıların açıkça belirtilmiş veya belirtilmemiş ihtiyaçları, talepleri ve beklentileri; çalışmalara ve süreçlere yol gösterir<sup>46</sup>.

## **VI- VERİ ÜRETİLEN KAYNAKLAR**

Adalet Bakanlığı’nın ilgili birimleri ile görev ve sorumluluk alanına giren tüm savcılık, mahkeme, icra müdürlükleri verilerinin yanısıra; Uyuşmazlık Mahkemesi, Hâkimler ve Savcılar Kurulu, Yüksek Hakem Kurulu, Anayasa Mahkemesi, Yargıtay Başkanlığı, Danıştay Başkanlığı, Türkiye Noterler Birliği, Adli Tıp Kurumu Başkanlığı ve Türkiye Barolar Birliği birimlerine ait bilgileri içeren idarî kayıtlardan Adalet İstatistikleri üretilmektedir.

## **VII-SAKLAMA YÖNTEMİ**

Veri üretilen kaynaklardan savcılık, mahkeme ve icra müdürlüklerine ilişkin veriler adli istatistik veri tabanında tutulmaktadır. Paydaş kurumlardan derlenen veriler ise elektronik ortamda arşivlenmektedir<sup>47</sup>.

Ayrıca şu hususu vurgulamak gerekir ki, UYAP İstatistik bilgi sistemine<sup>48</sup> de günlük adli istatistikler girilmektedir. Bu ise ülkemiz açısından önemli bir gelişmedir.

---

<sup>44</sup> RG. 20.06.2006, Sa. 26204

<sup>45</sup> <https://www.resmiistatistik.gov.tr/detail/resmi-istatistik-ilkeleri> (ET. 30.08.2023).

<sup>46</sup> <https://istatistik.gov.ct.tr/KURUMSAL/%C4%BOLKELER> ((ET. 30.08.2023).

<sup>47</sup> Bkz. <https://adlisicil.adalet.gov.tr>

<sup>48</sup> Bkz. <https://istatistikler.uyap.gov.tr> (ET. 26.08.2023).

Yaklaşık 15 yıl önce Türk Hukuk doktrininde yapılan ve o zamana göre kanımızca isabetli olan “ülkemizdeki adalet istatistikleri Adalet Bakanlığı ve Türkiye İstatistik Kurumu tarafından yayımlanmakta ise de, bunların tümüne erişebilmek ve bilim adamlarının bu konuda çalışma yapip değerlendirme yapabilmeleri oldukça zordur” şeklindeki eleştiri<sup>49</sup> de kanımızca şu an itibarıyla söz konusu değildir. Özellikle UYAP’ın ülkemizde çok ileri düzeyde kullanımı ve UYAP İstatistik bilgi sisteminin hayata geçirilmesi bu konuda bilim adamlarının çalışma yapip değerlendirme yapabilmelerini kolaylaştırmaktadır.

Bu nedenle istatistik ile hukuk biliminin ortak bir noktada buluşması ve farklı gibi görünen bu iki disiplinin birlikte birçok konuda araştırma yapması oldukça önem kazanmıştır.

### VIII- ADALET İSTATİSTİKLERİNDEN BAZI ÖRNEKLER (DİKKATİ ÇEKEN BAZI NOKTALAR)

#### A- CEZA DOSYALARI BAKIMINDAN

##### 1- Suç Oranları Bakımından

- **2021 ve 2022 Adalet İstatistikleri**, Türkiye’de suç oranlarında artış yaşandığını göstermektedir<sup>50</sup>. Adalet istatistiklerinde, ceza mahkemelerinde seçilen **on suç türüne göre** yıl içinde açılan dosya sayısı artış oranları incelendiğinde **2022 yılında** bir önceki yıla göre en fazla artışın sırasıyla dolandırıcılık, çocukların cinsel istismarı ve hırsızlık suç türlerinde olduğu görülmektedir. Suç işlemek amacıyla örgüt kurmak suçunda ise bir önceki yıla göre % 32 oranında azalma olmuştur<sup>51</sup>.

- **2023 Adalet İstatistiklerine** göre de, ceza mahkemelerinde seçilen on suç türüne göre yıl içinde açılan dosya sayısı artış oranları incelendiğinde **2023 yılında** bir önceki yıla göre en fazla artışın sırasıyla dolandırıcılık, kasten öldürme, yağma ve uyuşturucu veya uyarıcı madde imal ve ticareti suç türlerinde olduğu görülmektedir. Hırsızlık suçunda ise bir önceki yıla göre %11 oranında azalma olmuştur<sup>52</sup>.

- Özellikle hırsızlık, dolandırıcılık ve yağma gibi suçları kapsayan malvarlığına karşı işlenen suçlar, Türkiye’de en fazla işlenen suç grubu olmuştur. Hırsızlık suçunda **2021** yılına göre, **2022** yılında % **30** oranında artış olmuştur<sup>53</sup>. Buna karşılık hırsızlık suçunda **2023** istatistiklerine göre, bir önceki yıla göre % **11** oranında azalma olmuştur<sup>54</sup>.

- Tüm suç grupları içinde uyuşturucu suçunun oranı yüzde 5’e yükselirken, açılan dosya sayısı 2012 yılında 422 bine çıkmıştır. 2021 yılına göre 2022 yılında uyuşturucu suçunda (TCK 188-191) da % **25** oranında artış olmuştur.

- **2022** yılında, 2021 yılına göre kasten öldürme (TCK m. 81-83) suçunun % 17 oranında; kasten yaralama (TCK m. 86-87) suçunun ise % 11 oranında arttığı görülmektedir.

- **2021’de** 127 bine yükselen cinsel dokunulmazlığa karşı işlenen suçlarda ilk sırayı 44 bin rakamıyla "çocukların cinsel istismarı" almıştır. 2022 yılında ise cinsel saldırı (TCK m. 102) suçlarında % 4 oranında artış olmuştur. Çocukların cinsel istismarı (TCK m. 103) suçunun ise 2021 yılına göre, % 33 oranında arttığı görülmektedir<sup>55</sup>. **2023** istatistiklerinde ise çocukların cinsel istismarı suçunda azalma olmuştur<sup>56</sup>.

<sup>49</sup> **Yılmaz, Ejder**, Usul Ekonomisi, AÜHFD Yıl 2008, Cilt:..57 Sayı:1 [243-274], s. 257.

<sup>50</sup> Konuya ilişkin veriler basına da yansımıştır. Örnek olarak bkz. <https://t24.com.tr/haber/Turkiye-de-suc-oranlari-artiyor,1057612> (E.T. 2.9.2023).

<sup>51</sup> Adalet İstatistikleri-2022, s. 8.

<sup>52</sup> Adalet İstatistikleri-2023, s. 8.

<sup>53</sup> Adalet İstatistikleri-2022, s. 8.

<sup>54</sup> Adalet İstatistikleri-2023, s. 8.

<sup>55</sup> Adalet İstatistikleri-2022, s. 8.

<sup>56</sup> Adalet İstatistikleri-2023, s. 8.

## 2- Soruşturma Sayısı ile Şüpheli Sayısı Bakımından<sup>57</sup>

Adalet istatistikleri, Türkiye'de hem soruşturma hem de şüpheli sayısının her yıl düzenli olarak arttığını göstermektedir. Şöyle ki:

- 2014'te 6.9 milyon olan soruşturma sayısı, 2020'de 8 milyon 995 bin 141'e, 2021'de ise 9 milyon 856 bin 642'ye yükseldi. Buna karşılık bir soruşturmanın ortalama yürütülme süresinin ise arttığı, yani adaletin hızının yavaşladığı görülmektedir. 2014'te bir soruşturma 378 günde tamamlanırken, 2021'de 413 günde bitirilebilmiştir.

- 2021 Adalet İstatistiklerine göre, yaklaşık 85 milyon nüfusa sahip ülkemizde şüpheli sayısının arttığı görülmektedir. 2014'te 9.8 milyon şüpheli varken, 2020'de bu rakam 13 milyon 97 bin 311 oldu. 2021 yılındaki soruşturmalardaki şüpheli kişi sayısı ise 14 milyon 345 bin 936'ya yükselmiştir. Bu soruşturmalarda 10 milyon 903 bin 331 kişi ise "mağdur/müşteki" olmuştur.

- Ayrıca belirtmek gerekir ki, toplam şüpheliler içerisindeki "yabancı uyruklu" şüpheli sayısının da yükseldiği görülmektedir. Bu durum kanımızca, ülkemizde sığınmacı sayısının artmasının bir sonucudur. 2020 yılında 283 bin 82 yabancı uyruklu kişi şüpheli olurken, bu sayı 2021 yılında yaklaşık 100 bin artarak 383 bin 743'e çıkmıştır.

## 3- Açılan Ceza Davaları ve Verilen Kararlar Bakımından<sup>58</sup>

- 2021 yılında tüm başsavcılıklardaki soruşturmalar sonucunda % 55,7 'sine, yani 5 milyon 13 bin 705'ine takipsizlik kararı verilmiştir

- İstatistikler, Türkiye'de ceza mahkemelerinde her geçen yıl açılan dava sayısının da arttığını göstermektedir. 2020'de açılan dava sayısı 2 milyon 833 bin 473'tü. 2021 yılında ise 3 milyon 290 bin 195 dava açılmıştır.

- Bu davalardan 2 milyon 529 bin 492'sinde (yüzde 50,6) mahkûmiyet kararı, 674 bin 814'ünde (yüzde 13,5) hükmün açıklanmasının geri bırakılması<sup>59</sup>, 756 bin 767'sinde (yüzde 15,1) beraat kararı verildiği görülmektedir.

## 4- Uyuşturucu Davaları Bakımından Durum

- 2020'de 314 bin 466 uyuşturucu dosyası açılmış olup; bunun 192 bin 795'i uyuşturucu almak ve kullanmak, 99 bin 120'si uyuşturucu imal ve ticareti olmuştur. 2021 yılına gelindiğinde ise uyuşturucu suçlarında artış görüldüğü açıktır. Nitekim Uyuşturucu (TCK m. 188-191) ile ilgili suçlarda, 2022 yılında 2021 yılına göre % 25 artış olduğu görülmektedir<sup>60</sup>.

- 2021 yılında 422 bin 479 uyuşturucu suçundan soruşturma başlatılmış; uyuşturucu kullanmaktan 263 bin 650 dosya, ticaretinden ise 118 bin 699 dosya kaydı sisteme girilmiştir.

<sup>57</sup> Bkz. <https://t24.com.tr/haber/Türkiye-de-suc-oranlari-artiyor,1057612> (E.T. 2.9.2023).

<sup>58</sup> <https://t24.com.tr/haber/Türkiye-de-suc-oranlari-artiyor,1057612> (E.T. 2.9.2023).

<sup>59</sup> Belirtmek gerekir ki, Anayasa Mahkemesi (RG. 1. 8. 2023, Sa. 32266); Trabzon 2. Asliye Ceza Mahkemesi'nin itiraz yoluna başvurusu üzerine, 5271 sayılı Ceza Muhakemesi Kanunu'nun 231. maddesinin 5 ila 14. fıkralarında düzenlenen **hükmün açıklanmasının geri bırakılması (HAGB)** kurumuna ilişkin tüm hükümlerin oyçokluğu ile iptaline karar vermiştir. İptal hükümleri; Anayasanın 153. maddesinin üçüncü fıkrası ile 6216 sayılı Kanunun (3) numaralı fıkrası gereğince, iptal kararının Resmi Gazete'de yayımlanmasından başlayarak 1 yıl sonra yürürlüğe girecektir. Şu halde, Anayasa Mahkemesi'nin iptal kararlarının 1 Ağustos 2023 tarihinde Resmi Gazete'de yayımlandığı dikkate alındığında, iptallerin 1 Ağustos 2024 tarihinden yürürlüğe gireceğini, böylelikle hükmün açıklanmasının geri bırakılmasının müessese olarak yürürlükten kalkacağını belirtmek gerekir (**Şen, Ersan/ Serdar, Cem**, Anayasa Mahkemesi'nin HAGB'yi İptal Kararı, <https://sen.av.tr/tr/makale/anayasa-mahkemesinin-HAGByi-iptal-karari>; E.T. 15.09.2023).

<sup>60</sup> Adalet İstatistikleri-2022, s. 8.



2021'de uyuşturucu suçlarından ise 174 bin 978 dava açılmış; 2020'de uyuşturucu suçlarının oranı diğer tüm suç gruplarına göre yüzde 4,5'ken, 2021'de bu oran yüzde 5'e çıkmıştır.

- Ayrıca belirtmek gerekir ki, 2021 yılına göre 2022 yılında uyuşturucu suçunda (TCK 188-191) % 25 oranında artış olduğu görülmektedir.

- **2023** yılında bir önceki yıla göre en fazla artışın olduğu suçlar arasında uyuşturucu veya uyarıcı madde imal ve ticareti suç türlerinin olduğu belirtilmektedir<sup>61</sup>.

#### **B- Hukuk Dosyaları Bakımından**<sup>62</sup>

Hukuk mahkemelerinde seçilen on dava türüne göre yıl içinde açılan dosya sayısı artış oranları incelendiğinde **2022** yılında 2021 yılına göre en fazla artışın sırasıyla vesayet, itirazın iptali ve tazminat davası türlerinde olduğu görülmektedir. Alacak davasında ise bir önceki yıla göre %15 oranında azalma olmuştur<sup>63</sup>.

**2023** istatistiklerine göre ise, 2023 yılında bir önceki yıla göre en fazla artışın sırasıyla kamulaştırma, veraset ve nüfus dava türlerinde olduğu görülmektedir. Alacak ve şikâyet davalarında ise bir önceki yıla göre %6 oranında azalma olmuştur<sup>64</sup>.

Ayrıca **2023** yılı itibariyle hukuk mahkemelerine yıl içinde gelen toplam dava konusu sayısı 3.001.655'tir. Davaların konusuna bakıldığında, ilk on sırayı veraset, boşanma, vesayet, alacak, tazminat, itirazın iptali, kamulaştırma, şikâyet, tapu iptali ve tescil ve kiralananın tahliyesi aldığı görülmektedir<sup>65</sup>.

Şöyle ki:

**1-** Veraset davalarında, 2022 yılında bir önceki (2021'e) yıla göre % 11 artış olmuştur. Veraset davalarında 2023 yılı içinde açılan dosya indeksi (2022'de dosya indeksi 186 iken) 207 olmuş ve artış göstermiştir<sup>66</sup>.

**2-** Boşanma davalarında 2022 yılında bir önceki (2021'e) yıla göre % 5 oranında artış yaşanmıştır. Boşanma davalarında 2023 yılı içinde açılan dosya indeksi (2022'de dosya indeksi 143 iken) 144 olmuş ve çok az (bir birim) artış göstermiştir<sup>67</sup>.

**3-** Alacak davalarında 2022 yılında 2021 yılına göre % 15 oranında azalma olmuştur. Alacak davalarında 2023 yılı içinde açılan dosya indeksi (2022'de dosya indeksi 119 iken) 112 olmuş ve düşüş göstermiştir<sup>68</sup>.

**4-** Vesayet davalarında<sup>69</sup> 2022 yılında 2021 yılına göre % 29 oranında artış olmuştur. Vesayet davalarında 2023 yılı içinde açılan dosya indeksi (2022'de dosya indeksi 153 iken) 164 olmuş ve artış göstermiştir<sup>70</sup>.

**5-** Tazminat davalarında 2022 yılında 2021 yılına göre % 17 oranında artış olmuştur. Tazminat davalarında 2023 yılı içinde açılan dosya indeksi (2022'de dosya indeksi 132 iken) 134 olmuş ve çok az (iki birim) artış göstermiştir<sup>71</sup>.

---

<sup>61</sup> Adalet İstatistikleri-2023, s. 8.

<sup>62</sup> Adalet İstatistikleri 2022, s. 9.

<sup>63</sup> Adalet İstatistikleri 2022, s. 9.

<sup>64</sup> Adalet İstatistikleri-2023, s. 9.

<sup>65</sup> Adalet İstatistikleri-2023, s. 83.

<sup>66</sup> Adalet İstatistikleri-2023, s. 32.

<sup>67</sup> Adalet İstatistikleri-2023, s. 32.

<sup>68</sup> Adalet İstatistikleri-2023, s. 32.

<sup>69</sup> TMK m. 404 vd. hükümlerine göre, bir kişinin vesayet altına alınması gereken durumlar açıkça düzenlenmiştir. Buna göre şu durumlarda kişiler vesayet altına alınır: **a)** Küçüklük, **b)** Akıl hastalığı veya akıl zayıflığı, **c)** Savurganlık, **d)** Alkol veya uyuşturucu madde bağımlılığı, **e)** Kötü yaşama tarzı, kötü yönetim, **f)** Özgürlüğü bağlayıcı ceza, **g)** İstek üzerine.

<sup>70</sup> Adalet İstatistikleri 2023, s. 32.

<sup>71</sup> Adalet İstatistikleri 2023, s. 32.

6- İtirazın iptali davalarında 2022 yılında 2021 yılına göre % 25 oranında artış olmuştur. İtirazın iptali davalarında 2023 yılı içinde açılan dosya indeksi (2022’de dosya indeksi 187 iken) 184 olmuş ve çok az (üç birim) düşüş göstermiştir<sup>72</sup>.

7- Şikâyet taleplerinde 2022 yılında 2021 yılına göre % 7 oranında artış olmuştur. Şikâyet taleplerinde 2023 yılı içinde açılan dosya indeksi (2022’de dosya indeksi 112 iken) 106 olmuş ve düşüş göstermiştir<sup>73</sup>.

8- Kamulaştırma davalarında 2022 yılında 2021 yılına göre % 11 oranında artış olmuştur. Kamulaştırma davalarında 2023 yılı içinde açılan dosya indeksi (2022’de dosya indeksi 109 iken) 144 olmuş ve artış göstermiştir<sup>74</sup>.

9- Tapu iptali ve tescil davalarında 2022 yılında 2021 yılına göre % 11 oranında artış olmuştur. Tapu iptali ve tescil davalarında 2023 yılı içinde açılan dosya indeksi (2022’de dosya indeksi 149 iken) 146 olmuş ve çok az düşüş göstermiştir<sup>75</sup>.

10- Nüfus davalarında 2022 yılında 2021 yılına göre % 13 oranında artış olmuştur. Nüfus davalarında 2023 yılı içinde açılan dosya indeksi (2022’de dosya indeksi 115 iken) 127 olmuş ve artış göstermiştir<sup>76</sup>.

**C- Çeşitli Yargı Kollarındaki Dosya Sayılarına İlişkin Bazı Veriler <sup>77</sup>**

- **Adli Yargıda;** Yargıtay Cumhuriyet Başsavcılığı’na 2022 yılında gelen dosya sayısı 2015 yılına göre % 65.7, Ceza Genel Kurulu ve Ceza Dairelerinde %41.3, Hukuk Genel Kurulu ve Hukuk Dairelerinde ise % 71.1 oranında azaldı. Bir önceki yıla göre ise Yargıtay Cumhuriyet Başsavcılığı’na gelen dosya sayısı % 28.4, Ceza Genel Kurulu ve Ceza Dairelerine gelen dosya sayısı %15.7, Hukuk Genel Kurulu ve Hukuk Dairelerine gelen dosya sayısı ise %18.6 oranında azalmıştır.

- **Bölge adliye mahkemelerinde** 2022 yılında gelen dosya sayısı 2017 yılına göre % 219.5, bir önceki yıla göre ise %12.2 oranında artmıştır,

- **Cumhuriyet başsavcılıklarına** 2022 yılında gelen dosya sayısı 2015 yılına göre % 47.5, bir önceki yıla göre ise %7.5 oranında artmıştır.

- **Adli yargı ilk derece mahkemelerinde** 2022 yılında **hâkim başına düşen dosya sayısı** 2015 yılına göre % 9.3 oranında azalmış; 2021 yılına göre ise % 3.6 oranında artmıştır.

- **Ceza mahkemelerinde** 2022 yılında gelen dosya sayısı 2015 yılına göre %26.1, **hukuk mahkemelerinde** % 36.3 oranında artmıştır. Bir önceki yıla göre ise ceza mahkemelerine gelen dosya sayısı % 0.3, hukuk mahkemelerinde %6.8 oranında artmıştır.

- **İdari Yargıda;** Danıştay dairelerine 2022 yılında gelen dosya sayısı 2015 yılına göre %44.8, bir önceki yıla göre ise %12.2 oranında azalmıştır. Bölge idare mahkemelerinde 2022 yılında gelen dosya sayısı 2015 yılına göre %152.0, bir önceki yıla göre ise %23.1 oranında arttı. İdarî yargı ilk derece mahkemelerinde 2022 yılında hâkim başına düşen dosya sayısı 2015 yılına göre %15.6, bir önceki yıla göre ise 3.8 oranında artmıştır. İdare mahkemelerinde 2022 yılında gelen dosya sayısı 2015 yılına göre %44.1, vergi mahkemelerinde %11.8 oranında artmıştır. Bir önceki yıla göre ise idare mahkemelerine gelen dosya sayısı %9.4 oranında artmış, vergi mahkemelerinde %12.3 oranında azalmıştır.

---

<sup>72</sup> Adalet İstatistikleri 2023, s. 32.

<sup>73</sup> Adalet İstatistikleri 2023, s. 32.

<sup>74</sup> Adalet İstatistikleri 2023, s. 32.

<sup>75</sup> Adalet İstatistikleri 2023, s. 32.

<sup>76</sup> Adalet İstatistikleri 2023, s. 32.

<sup>77</sup> Bkz. Adalet Bakanlığı, Adli Sicil ve İstatistik Genel Müdürlüğü, Haber Bülteni, Sayı:17 02, Haziran 2023.

## IX- SONUÇ VE DEĞERLENDİRME

İstatistik ve bilgi toplumu arasındaki bir ilişki olduğu, adalet alanındaki gelişim ve değişimlerin de istatistik açısıyla yakından takip etmeyi gerekli kıldığı bilinmektedir. Dijitalleşmenin ve internetin insan hayatını tüm yönleriyle kuşattığı günümüzde; istatistik, disiplinler arası bir iletişim aracı ve objektif bir bilgi kaynağı olarak oldukça önemli bir disiplin olarak karşımıza çıkmaktadır.

Bu çerçevede adalet istatistikleri, istatistik biliminin yargı alanına tahsis edilmesiyle ortaya çıkmış ve özellikle son dönemde devletlerin yargı politikalarının belirlenmesinde en önemli parametrelerden biri haline gelmiştir.

Özellikle istatistik biliminden hareketle adalet teşkilatının ve mahkeme kararlarının tasnif edilmesi, toplum ve devlet nezdinde farkındalık da yaratacak; bildiğimizi sandığımız bazı sorunlarla somut olarak yüzleşmemizin de önünü açacaktır.

Bu kapsamda, istatistik biliminin hukukla yakından ilgisi olduğu gibi, sosyoloji, psikoloji, ekonomi, yönetim bilimi ve ilahiyat gibi birçok disiplinle yakından ilişkisi olduğu unutulmamalıdır. Bu nedenle de farklı disiplinlerde çalışan bilim adamlarının bilimsel bilgi ve güçlerini birleştirmeleri ve ortak yayınlar ve öneriler getirebilmeleri oldukça önem arz etmektedir.

Örneğin hırsızlık suçunu işleyen bir fail ile ilgili olarak aşağıdaki sorular sorulabilir:

- Suçun unsurları TCK'da belirtilen şekliyle gerçekleşmiş midir? (Hukuk)
- Bu suç suçun işlendiği yıl itibariyle sayı olarak ne kadardır ve geçen yıla göre nasıl bir seyir izlemiştir? Yani suç oranında artma mı yoksa azalma mı olmuştur? (İstatistik)
- Failin suçu işlemesinde ekonomik etkenler etkili olmuş mudur? (Ekonomi)
- Failin dini duyarlılığı/ dindarlığı veya maneviyatı suçun işlemesinde ne derece etkili olmuştur? (İlahiyat)
- Failin içinde yaşadığı toplumsal yapı ve ailede aldığı eğitim (ve özellikle failin hayat hikayesi) suçun işlenmesinde ne derece etkili olmuştur? (Sosyoloji)
- Failin içinde bulunduğu haleti ruhiye (psikoloji) suçun işlenmesinde etkili olmuş mudur? (Psikoloji)
- Failin yönetime olan tepkisi, suçun işlenmesini tetiklemiş midir? (Yönetim Bilimi).

İşte yukarıdaki soruların cevaplarının alınabilmesi temelde istatistik biliminin verileri ortaya çıktıktan sonra bir anlam ifade edecektir. Zira hırsızlık suçunun hiç işlenmediğinin istatistiki verilerle ortaya çıkması durumunda diğer soruların cevaplarını bulmaya da ihtiyaç kalmayacaktır. Bir başka deyişle, adalet istatistikleri adeta hastalığa ilişkin verilerin (film, tetkik ve tahlillerde olduğu gibi) doğru bir şekilde tespit ve teşhisine imkan verecektir.



**Farklı Enerji İçerikli Karma Yemlere Emülsifiyer İlavesinin Etlik Piliçlerin Canlı Ağırlıkları Üzerine Etkisinin Profil Analizi ile İncelenmesi**

**Senay Sarıca<sup>1\*</sup>, Seçil Burcu Alkaç<sup>2</sup>, Sıddık Keskin<sup>3</sup>, Emine Berberoğlu<sup>1</sup>**

<sup>1</sup>Tokat Gaziosmanpaşa Üniversitesi, Ziraat Fakültesi, Zootehni Bölümü, 60240 Tokat, Türkiye

<sup>2</sup>Yüksek Lisans Öğrencisi

<sup>3</sup>Van Yüzüncü Yıl Üniversitesi, Tıp Fakültesi, Temel Bilimler Bölümü, 65090 Van, Türkiye

\*Sorumlu yazar e-mail: senay.sarica@gop.edu.tr

**Özet**

Çok değişkenli varyans analizi (MANOVA), birden fazla cevap (yanıt) değişkenini birlikte ele alarak, bu değişkenlerin ortalamaları bakımından, ilgili faktör (grup) veya faktörlerin seviyeleri arasında fark olup olmadığını inceler. Çok değişkenli varyans analizinde, ilgilenilen özellik farklı zamanlarda (dakika, saat, gün, hafta, ay, yıl) ölçülmüş bir değişken ise bu değişken için zaman, bağımlı faktör olarak adlandırılır ve bu bağımlı faktörün seviyelerinde yapılan ölçümler de periyot olarak adlandırılır. Bu yapıdaki deney tasarımlarının analizi, genellikle Tekrarlanan ölçümlü varyans analizi olarak bilinir. Tekrarlanan ölçümlü varyans analizi ile ilişkili ve bu analizin kısmen basit formu olan Profil analizi kısaca, ilgilenilen özellik bakımından bireyler arası ve bireyler içi ölçüm değerlerinin benzerlik durumlarını test etmek veya diğer bir ifade iki ya da daha fazla grubun benzer profillere sahip olup olmadığını belirlemek üzere kullanılır. Profil analizinde genellikle, x ekseninde bağımlı faktörün seviyeleri, y ekseninde ise bağımsız faktörün seviyeleri alınarak ilgilenilen özellik bakımından ortalamalar gösterilir. Böylece profillerin paralel olup olmadığı ve ortalamaların bağımsız faktörün seviyelerinde aynı olup olmadığı test edilebilir. Bu çalışmada, profil analizinin genel özelliklerine değinilerek, rasyonda 3 farklı enerji düzeyi (seviyesi) ve 3 farklı düzeyde emülsifiyer ilavesinin, etlik piliçlerdeki canlı ağırlık üzerine etkisi profil analizi ile incelenmiştir. Çalışma sonucunda; profil analizinin 2 bağımsız faktör ve bir bağımlı faktör olması durumunda da uygulanabilirliği gözlenmiş ve Tekrarlanan ölçümlü varyans analizi ve MANOVA'ya göre profil analizinin, okuyucuya kısmen de olsa daha basit ve kolay anlaşılabilir görsel bilgiler sunabileceği vurgulanmıştır.

**Anahtar Kelimeler:** Profil, Paralellik, Periyot, Emülsifiyer, Etlik Piliç

**Investigation of Effects of Emulsifier Supplementation to Diets with Different Energy on Body Weights of Broiler Chickens by Profile Analysis**

**Abstract**

Multivariate analysis of variance (MANOVA) considers more than one response or dependent variable together and examines whether there is a difference between the levels of the relevant factor (group) or factors in terms of the averages of these variables. In multivariate analysis of variance, when the feature of interest is a variable measured at different time period (minutes, hours, days, weeks, months, years), this variable is called the dependent factor, and the levels of this dependent factor are called period. Analysis of experimental designs of this structure is commonly known as repeated measures analysis of variance. Profile analysis, which is related to repeated measures analysis of variance and is a relatively simple form of this analysis, is briefly used to test the similarity of inter- and intra-individual measurement values in terms of the feature of interest, or in other words, to determine whether two or more groups have similar profiles. In profile analysis, the levels of the dependent factor are generally set on the x-axis, and the levels of the independent factor are set on the y-axis, and the averages are shown for the feature of interest. Thus, it can be tested whether the profiles are parallel and whether the means are the same across the levels of the independent factor. In this study, by mentioning of the general features of profile analysis, the effects of 3 different energy levels and 3 different emulsifier supplementation in diet on body weights of broiler chickens were examined by profile analysis. In the

*results of the study; the applicability of profile analysis in the case of 2 independent factors and one dependent factor has been observed, and it has been emphasized that profile analysis, compared to repeated measures analysis of variance and MANOVA, can provide the reader with simpler and more easily understandable visual information, albeit partially.*

**Keywords:** Profile, Parallelism, Period, Emulsifier, Broiler

## GİRİŞ

Bilimsel çalışmalarda, araştırmaya konu olan özellik veya değişkenler bakımından, aynı deney ünitelerinden (deneklerden veya örneklem biriminden) farklı zamanlarda ölçümler alınabileceği gibi aynı deney ünitelerinin farklı bölgelerinden de ölçümler alınabilir. Farklı zamanlarda alınan ölçümler için zaman faktörü genellikle periyod olarak ifade edilir ve bu periyodlardaki ölçümler de tekrarlanan ölçüm olarak adlandırılır. Benzer şekilde aynı deney ünitelerinin farklı bölgelerinden alınan ölçümler (omuz, sırt, bel; sağ-sol; alt çene-üst çene vb.) veya aynı deney ünitelerinin farklı değişkenlere vermiş olduğu cevaplar da tekrarlanan ölçüm olarak bilinir. Her iki durumda da, aynı deney ünitelerinden alınan bu gibi ölçümler, birbirine bağımlı olup, bu bağımlı ölçümleri içeren faktör de bağımlı grup olarak adlandırılır.

Bir denemede, bağımlı faktörün yalnızca iki seviyesi var ise Eş Yapma t testi veya Eşleştirilmiş t testi (Paired t test) olarak da bilinen parametrik test yaygın olarak kullanılmaktadır. Bağımlı faktörün seviye sayısının ikiden fazla olması durumunda ise yaygın kullanılan parametrik test yöntemi, Tekrarlanan ölçümlü varyans analizidir. Bağımlı grup ile birlikte; cinsiyet, ırk, çeşit, varyete veya herhangi bir uygulamanın (muamelenin) da bağımsız faktör olarak alınması durumunda, İki faktörlü ve faktörlerden birisi tekrarlanan ölçümlü varyans analizi modeli kullanılabileceği gibi çoğunlukla MANOVA (Multivariate Analysis of Variance) olarak da bilinen Çok Değişkenli Varyans Analizi kullanılabilmektedir. Bu gibi durumlarda kullanılabilen Profil analizi ise Çok Değişkenli Varyans Analizinin (MANOVA) özel bir uygulaması olarak düşünülebilir. Diğer bir ifade ile Profil analizi, Tekrarlanan ölçümlü varyans analizine (Repeated Measures ANOVA) Çok değişkenli varyans analizi yaklaşım olarak da düşünülebilir.

Yapılan literatür incelemesinde, Profil analizi ile ilgili çalışmaların oldukça sınırlı olduğu gözlenmiştir. Bu nedenle ele alınan bu çalışmada, Profil analizinin genel özelliklerine değinilmiş ve iki bağımsız faktörle birlikte bir bağımlı faktörün; etlik piliçlerde canlı ağırlığa etkisini belirlemek üzere Profil analizinden yararlanılarak bu analizin kullanılabilirliği değerlendirilmiştir.

## MATERYAL VE YÖNTEM

### Materyal

#### *Hayvan Materyali*

Araştırmada hayvan materyali olarak günlük yaşta 720 adet Ross 308 ticari etlik erkek civciv kullanılmış olup, ticari bir tavukçuluk kuluçkahanesinden temin edilmiştir.

#### *Yem Materyali*

Araştırmada kullanılacak karma yemlerin yapısındaki yem ve yem katkı maddeleri piyasadan temin edilmiştir. Yem maddelerinin analiz edilen ham besin maddesi içerikleri dikkate alınarak karma yemler Tokat Gaziosmanpaşa Üniversitesi Ziraat Fakültesi Zootekni Bölümü'ndeki karma yem hazırlama ünitesinde hazırlanmıştır.

### Yöntem

Araştırmada deneme başı canlı ağırlıkları istatistiki olarak birbirine benzer olan toplam 9 grup ve 4 tekerrürlü ve her bir tekerrürde de 20 adet etlik erkek civciv bulunacak şekilde toplam 720 adet etlik erkek civciv kullanılmıştır. Araştırma, Tokat Gaziosmanpaşa Üniversitesi Tarımsal Uygulama ve

Araştırma Merkezi bünyesindeki etlik piliç ünitesindeki yerde altlık üzerinde Tesadüf Parselleri Deneme Deseninde 3x3 faktöriyel düzenlenmiş deneme planına göre yürütülmüştür. Deneme karma yemlerine ilave edilen emülsifiyer kaynağı lizolesitin (Lysoforte) Egevizyon Yem Tarım ve Hayvancılık San. Tic. Ltd. Şti'nden temin edilmiştir. Çalışmada etlik piliç Ross 308'e ait besin maddesi gereksinimleri dikkate alınarak 0-10. gün başlatma (3025 Kkal/kg ME ve % 23 HP), 11-28. gün büyütme (3150 Kkal/kg ME ve % 22 HP) ve 29-42. gün bitirme (3200 Kkal/kg ME ve % 19 HP) rasyonları hazırlanmıştır. Deneme rasyonları; 1. Rasyon: Soya yağı içeren ve enerji düzeyi normal rasyon; 2. Rasyon: 1. rasyon+250 g/ton lizolesitin (Lysoforte) ilaveli rasyon; 3. Rasyon: 1. rasyon+ 500 g/ton lizolesitin (Lysoforte) ilaveli rasyon; 4. Soya yağı içeren ve enerji içeriği 60 Kkal/kg ME azaltılmış rasyon; 5. Rasyon: 4. rasyon+ 250 g/ton lizolesitin (Lysoforte) ilaveli rasyon; 6. Rasyon: 4. rasyon+ 500 g/ton lizolesitin (Lysoforte) ilaveli rasyon; 7. Soya yağı içeren ve enerji içeriği 120 Kkal/kg ME azaltılmış rasyon; 8. Rasyon: 7. rasyon+ 250 g/ton lizolesitin (Lysoforte) ilaveli rasyon; 9. Rasyon: 7. rasyon+ 500 g/ton lizolesitin (Lysoforte) ilaveli rasyon şeklinde hazırlanmıştır. Deneme, civcivlerin kuluçkadan çıktığı ilk günden 42 günlük yaşa kadar devam etmiştir. Araştırma süresince deneme başlangıcında ve deneme süresince haftalık tartımlarla etlik piliçlerin canlı ağırlıkları ölçümleri alınmıştır.

#### İstatistik Analiz

Çalışmada ele alınan özellik olan canlı ağırlık için tanımlayıcı istatistikler ortalama ve standart hata olarak ifade edilmiştir. Altı haftalık süredeki canlı ağırlık ortalamalarına; iki bağımsız faktör (Enerji düzeyi ve Emülsifiyer ilavesi) ve bir bağımlı faktörün (Zaman) etkisini incelemek üzere Tekrarlanan Ölçümlü Varyans Analizi ile birlikte Profil analizi yapılmıştır.

Üç faktörlü ve faktörlerden biri bağımlı olan Tekrarlanan Ölçümlü Varyans Analizi için model:

$$Y_{ijkm} = \mu + \alpha_i + \beta_j + \alpha\beta_{ij} + \pi m_{(ij)} + \gamma_k + \alpha\gamma_{ik} + \beta\gamma_{jk} + \alpha\beta\gamma_{ijk} + \gamma\pi km_{(ij)} + \varepsilon_{l(ijkm)}$$

olarak yazılır (Gürbüz ve ark., 2003).

#### Profil Analizi

Profil analizinde üç test yapılabilmektedir. Bunlardan birincisi profillerin paralellik testidir. Profillerin paralellik testi, grupların aynı profillere sahip olup olmadığını test eder. Profil analizinde paralellik testi olarak bilinen bu test, Tekrarlanan Ölçümlü Varyans Analizine alternatif olarak Profil analizinin kullanılması durumunda, interaksiyon etkisinin testi olarak değerlendirilir. İkinci olarak grupların genel ortalamalarının farklı olup olmadığını testidir. Diğer bir ifade ile Profil analizindeki ikinci test, grupların esas (ana) etkilerinin farklı olup olmadığını testidir. Bu test, Varyans analizinde grupların esas ya da ana etkilerinin testi olarak bilinir. Profil analizinde üçüncü olarak profillerin düzlük testi yapılır. Bu test, gruplardan bağımsız olarak, bütün bağımlı değişkenlerin aynı tepki veya cevabı verip vermediğinin testidir. Gruplardan bağımsız olarak bütün bağımlı değişkenlerin aynı etkiyi gösterip göstermediğinin testi, Profil analizi terminolojisinde düzlük (flatness) testi olarak bilinir. Bu test, paralellik testi ile yakından ilişkilidir. Profiller paralel değilse, bunlardan en az birisinin düz olmadığı şeklinde yorumlanır (Tabachnick ve Fidell, 2001).

Tüm istatistik hesaplamalarda, önemlilik (anlamlılık) düzeyi %5 olarak alınmış ve hesaplamalar için SPSS (versiyon: 25) istatistik paket programı kullanılmıştır.

#### BULGULAR VE TARTIŞMA

Çalışmada canlı ağırlığa (g) ilişkin emülsifiyer, enerji düzeyi ve haftalara göre tanımlayıcı istatistikler ve karşılaştırma sonuçları Tablo 1'de verilmiştir. Tablo 1'de görüldüğü üzere; tüm haftalarda "enerji düzeyi x emülsifiyer düzeyi" interaksiyonu (etkileşimi) istatistik olarak önemli bulunmamıştır. Benzer şekilde, Emülsifiyer ve Enerji düzeyine ilişkin ortalamalar arası farklılıklar da önemli bulunmamıştır.



**V. International Applied Statistics Congress (UYİK - 2024)**  
**İstanbul / Türkiye, May 21-23, 2024**

**Tablo 1.** Canlı ağırlık için Enerji ve Emülsifiyere göre tanımlayıcı istatistikler ve karşılaştırma sonuçları

Parametre	Emülsifiyer	Enerji						Emülsifiyer (p)	Enerji x Emülsifiyer (p)
		Enerji 1		Enerji 2		Enerji 3			
		Ort.	SH	Ort.	SH	Ort.	SH		
Canlı Ağırlık (g) [Başlangıç]	1	44.28	0.40	44.13	0.43	44.38	0.62	0.938	0.999
	2	44.09	0.54	44.11	0.16	44.19	0.58		
	3	44.32	0.59	44.41	0.35	44.47	0.57		
	Enerji (p)	0.805							
Canlı Ağırlık (g) [1. Hafta]	1	138.18	2.57	128.50	2.99	137.30	4.67	0.191	0.126
	2	123.56	5.27	128.22	5.10	142.77	2.47		
	3	127.20	5.46	129.69	6.55	126.48	5.36		
	Enerji (p)	0.228							
Canlı Ağırlık (g) [2. Hafta]	1	302.55	7.66	289.26	9.67	299.53	7.98	0.402	0.818
	2	294.75	7.72	281.98	9.08	297.34	7.38		
	3	289.12	13.02	289.72	5.03	287.07	3.04		
	Enerji (p)	0.456							
Canlı Ağırlık (g) [3. Hafta]	1	681.85	17.44	617.01	19.81	670.31	7.99	0.007	0.078
	2	655.22	14.90	591.76	18.83	655.51	18.01		
	3	652.89	10.99	664.23	11.80	658.86	9.29		
	Enerji (p)	0.113							
Canlı Ağırlık (g) [4. Hafta]	1	1236.32	26.27	1187.29	25.64	1203.69	12.11	0.115	0.224
	2	1223.76	45.49	1105.31	18.71	1222.71	55.22		
	3	1168.99	19.65	1175.90	31.52	1161.41	14.43		
	Enerji (p)	0.294							
Canlı Ağırlık (g) [5. Hafta]	1	1833.07	39.66	1784.24	61.46	1740.76	11.83	0.682	0.071
	2	1842.98	51.95	1702.48	23.53	1789.44	43.53		
	3	1716.23	48.39	1812.73	52.02	1844.21	54.28		
	Enerji (p)	0.942							
Canlı Ağırlık (g) [6. Hafta]	1	2582.68	78.45	2499.65	16.61	2368.25	7.98	0.035	0.633
	2	2528.93	70.43	2388.11	36.58	2369.04	45.05		
	3	2480.70	28.23	2451.96	50.56	2432.18	123.01		
	Enerji (p)	0.554							

Ort: Ortalama; SH: Standart Hata

Tekrarlanan Ölçümlü Varyans Analizi sonuçları Tablo 2'de özetlenmiştir. Tablo 2'de görüldüğü üzere, zamanlar arası fark dışında, diğer faktörlere ve interaksyonlara ilişkin test sonuçlarında, faktörlerin esas (ana) etkileri ve interaksyon etkileri istatistik olarak önemli bulunmamıştır. Cıvıvlerde zamana bağlı olarak ağırlık artışı olduğundan, zamanlar arası farkın istatistik olarak önemli bulunması beklenen durumdur.

**Tablo 2.** Tekrarlanan Ölçümlü Varyans Analizi sonuçları

Varyasyon Kaynağı	Ser. Der.	Kareler Toplamı	Kareler Ortalaması	F	P
Zaman	1	126130716	126130716	16480.962	0.001
Zaman * Enerji	2	37481	18740	2.449	0.115
Zaman * Emülsifiyer	2	5967	2983	0.390	0.683
Zaman * Enerji * Emülsifiyer	4	42246	10561	1.380	0.280
Hata (Zaman)	18	137756	7653		
Sabit	1	165269499	165269499	21375	0.001
Enerji	2	32305.895	16152	2.089	0.153
Emülsifiyer	2	9357	4678	0.605	0.557
Enerji * Emülsifiyer	4	47155	11788	1.525	0.237
Hata	18	139170	7731		

Ser. Der.: Serbestlik Derecesi

Çok değişkenli analiz sonuçları da Tablo 3'de özetlenmiştir. Tablo 3 incelendiğinde de; zaman faktörü dışında, interaksyon etkilerinin istatistik olarak önemli olmadığı görülmüştür. Buna göre emülsifiyer ilavesinin etkilerinin, rasyonun enerji düzeyindeki farklılığa göre değişmediği söylenebilir. Benzer şekilde, farklı enerji düzeyi etkilerinin de farklı düzeylerde emülsifiyer ilavesine göre değişmediği söylenebilir.

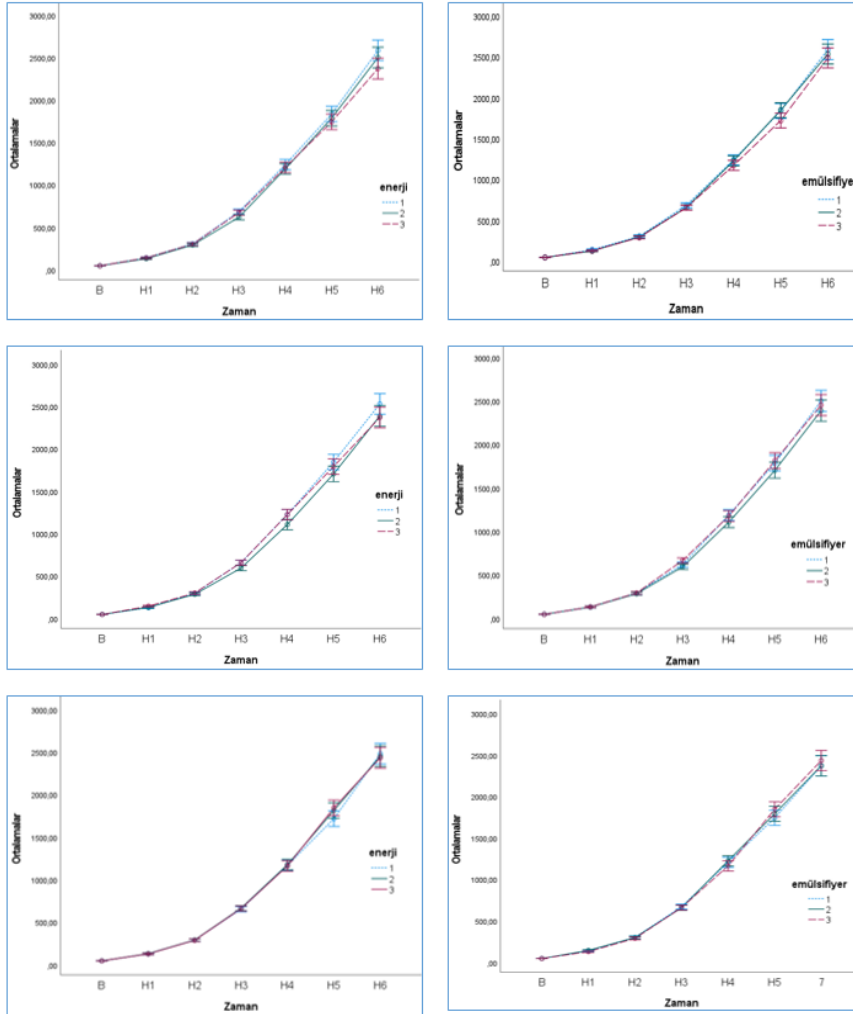
**V. International Applied Statistics Congress (UYİK - 2024)**  
**İstanbul / Türkiye, May 21-23, 2024**

**Tablo 3.** Çok değişkenli varyans analizi sonuçları

Etkiler		Değer	F	Ser. Der.	Hata Ser. Der.	P
Zaman	Pillai's Trace	0.999	3028.661	6	13	0.001
	Wilks' Lambda	0.001	3028.661	6	13	0.001
	Hotelling's Trace	1397.843	3028.661	6	13	0.001
	Roy's Largest Root	1397.843	3028.661	6	13	0.001
Zaman * Enerji	Pillai's Trace	1.069	2.677	12	28	0.056
	Wilks' Lambda	0.209	2.578	12	26	0.051
	Hotelling's Trace	2.465	2.465	12	24	0.059
	Roy's Largest Root	1.669	3.893	6	14	0.057
Zaman * Emülsifiyer	Pillai's Trace	0.646	1.114	12	28	0.388
	Wilks' Lambda	0.455	1.046	12	26	0.440
	Hotelling's Trace	0.977	0.977	12	24	0.496
	Roy's Largest Root	0.617	1.439	6	14	0.268
Zaman * Enerji * Emülsifiyer	Pillai's Trace	1.359	1.372	24	64	0.158
	Wilks' Lambda	0.157	1.361	24	46	0.181
	Hotelling's Trace	2.684	1.286	24	46	0.227
	Roy's Largest Root	1.406	3.749	6	16	0.056

Ser. Der.: Serbestlik Derecesi; Hata Ser. Der.: Hata Serbestlik Derecesi

Farklı emülsifiyer ve enerji seviyelerinde zamana göre profiller Şekil 1'de verilmiştir. Şekil 1 incelendiğinde; profil analizi sonucunda paralellik testine ait test hipotezinin kabul edildiği, yani profillerin paralel olduğu; benzer şekilde, bağımsız faktörlere ilişkin esas etkilerin de istatistik olarak önemli bulunmadığı söylenebilir. Profil analizinde gruplardan bağımsız olarak bütün bağımlı değişkenlerin aynı eğilim gösterdiği yani düzlük testine ilişkin test hipotezi de kabul edilebilmektedir.



**Şekil 1.** Farklı emülsifiyer ve enerji seviyelerinde zamana göre profiller

## SONUÇ

Çalışma sonucunda; profil analizinin 2 bağımsız faktör ve bir bağımlı faktör olması durumunda da uygulanabilirliği gözlenmiş ve Tekrarlanan Ölçümlü Varyans Analizi ve MANOVA'ya göre profil analizinin, okuyucuya kısmen de olsa daha basit ve kolay anlaşılabilir görsel bilgiler sunabileceği vurgulanmıştır.

## KAYNAKLAR

Gürbüz F, Başpınar E, Çamdeviren H, Keskin S, 2003. Tekrarlanan ölçümlü deneme düzenlerinin analizi. Van Yüzüncü yıl Üniversitesi Matbaası. 121.121p.

Tabachnick BG, Fidell LS, 2001. Using multivariate statistics. Fourth Edition. Allyn and Bacon. pp. 391-455.







**ABSTRACT  
POSTER  
PRESENTATIONS**

**A Modified Chi-Square Type Test for Distributional Validity with Applications to Right Censored Reliability and Medical Data**

**Aidi Khaoula**<sup>1\*</sup>

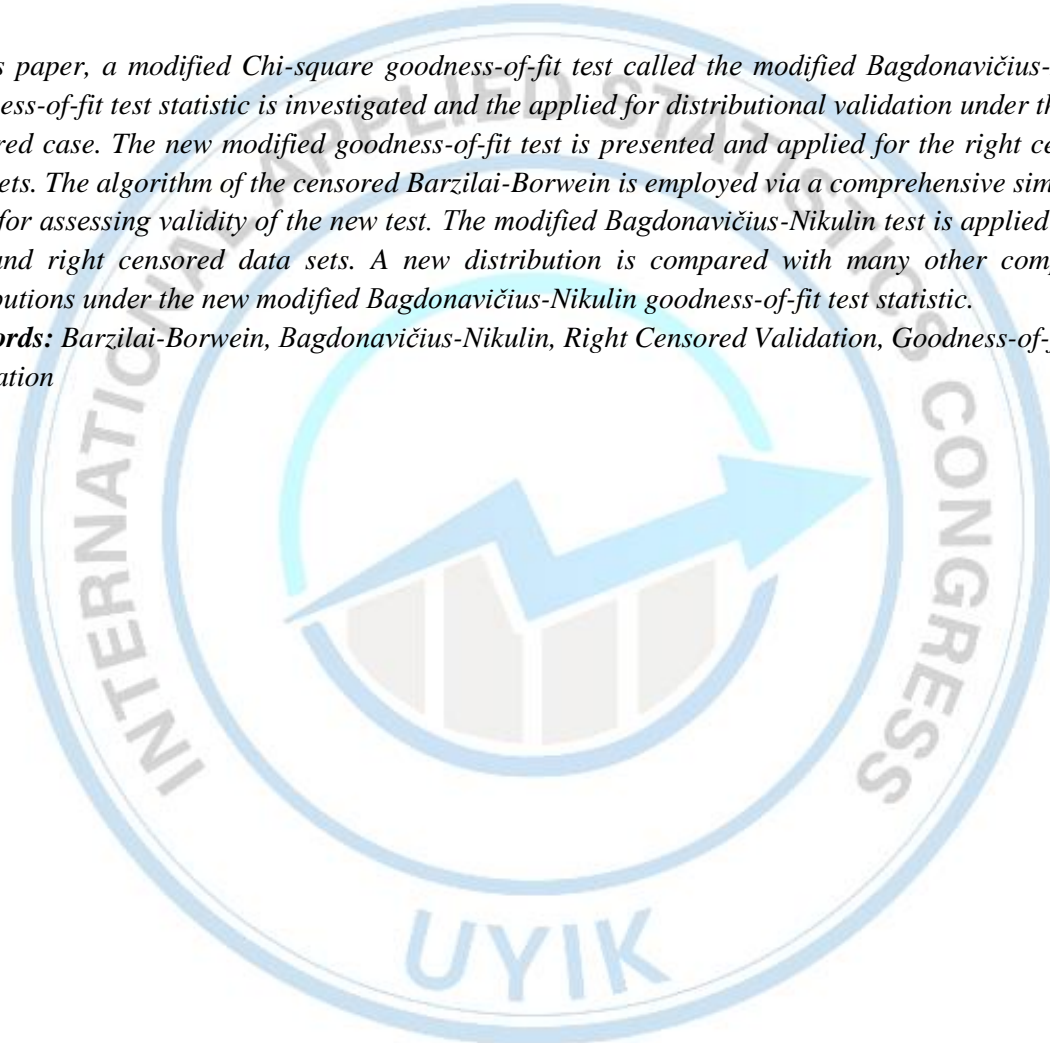
<sup>1</sup>Laboratory of Probability and Statistics LaPS Badji Mokhtar University, Annaba, Algeria

\*Corresponding author e-mail: khaoula.aidi@yahoo.fr

***Abstract***

*In this paper, a modified Chi-square goodness-of-fit test called the modified Bagdonavičius-Nikulín goodness-of-fit test statistic is investigated and the applied for distributional validation under the right censored case. The new modified goodness-of-fit test is presented and applied for the right censored data sets. The algorithm of the censored Barzilai-Borwein is employed via a comprehensive simulation study for assessing validity of the new test. The modified Bagdonavičius-Nikulín test is applied to four real and right censored data sets. A new distribution is compared with many other competitive distributions under the new modified Bagdonavičius-Nikulín goodness-of-fit test statistic.*

**Keywords:** *Barzilai-Borwein, Bagdonavičius-Nikulín, Right Censored Validation, Goodness-of-fit Test, Simulation*



**A New Model of Nadarajah Haghghi: Properties, Characterizations, Modeling  
Environmental Data**

**Aidi Khaoula**<sup>1\*</sup>

<sup>1</sup>Laboratory of probability and statistics LaPS Badji Mokhtar university-Annaba-Algeria

\*Corresponding author e-mail: khaoula.aidi@yahoo.fr

***Abstract***

*A new three-parameter extension of the generalized Nadarajah-Haghghi model is introduced and studied. Some of its statistical properties are derived. Characterization results are presented. Simple type Copula based construction via Morgenstern family or clayton copula is introduced. The failure rate can be increasing, decreasing, bathtub (U), upside-down, upside-down-constant, increasing-constant or constant. Variance, skewness and kurtosis were studied and analyzed via a numerical analysis. A Monte Carlo simulation study is performed to assess and analyze the performance of the estimation method. The flexibility of the new model is illustrated by a real data set.*

**Keywords:** *Nadarajah Haghghi Model, Characterizations, Morgenstern Family, Clayton Copula, Moments, Numerical Analysis, Simulation*





**A Study on the Choice of Index and Form the Market Model for Indian It Sector Stocks**

**Mihir Dash<sup>1\*</sup>, Rita Samikannu<sup>2</sup>**

<sup>1</sup>Alliance University, Department of Statistics

<sup>2</sup>Periyar University, Department of Statistics

\*Corresponding author e-mail: mihir@alliance.edu.in

***Abstract***

*This study examines the choice of index in the market model. The market model is used to identify systematic risk, which according to the CAPM is the only form of risk that is rewarded by excess returns. The usual diversified stock market index, which is generally constructed as a capitalisation-weighted average of major stock prices, is, according to the CAPM, hypothesised to be mean-variance efficient. The choice of index would impact portfolio construction techniques and portfolio performance evaluation measures, therefore playing an important role in portfolio theory. The study considers the market model for IT stocks in the Indian stock market, the National Stock Exchange. Along with the Nifty 50 index, the study considers other possible choices for the index, including the sectoral Nifty-IT index, the S&P 500 index, the USD-INR exchange rate, and the money market rate. The study also examines some other possible forms of the market model. The analysis was performed for a sample of twenty IT sector stocks listed on the National Stock Exchange of India. The study period considered was 2014–24.*

**Keywords:** Market Model, Choice of Index, IT Sector, Systematic Risk, CAPM

## Türkiye’de Boşanma Davası Sayılarının Zaman Serisi Analizi

Ayşe Yener<sup>1\*</sup>, Aytaç Akçay<sup>2</sup>

<sup>1</sup>Ankara Üniversitesi, Sağlık Bilimleri Enstitüsü, Biyoistatistik Anabilim Dalı, 06070, Türkiye, Ankara

<sup>2</sup>Ankara Üniversitesi, Veteriner Fakültesi, Biyoistatistik Anabilim Dalı, 06070, Türkiye, Ankara

\*Sorumlu yazar e-mail: aysekucuk22@gmail.com

### Özet

*Boşanma davası, evlilik birliğinin sona erdirilmesini amacıyla başvurulmuş hukuki bir süreçtir. Boşanma davası süreci, dava başvurusu, dava karar aşaması, itiraz süreci (varsa), kesinleşme ve uygulama (dava devam ederken de uygulama görülebilir) aşamalarını kapsar. Türkiye’de son beş yılda ortalama 272.925 boşanma davası açıldığı bildirilmektedir. Bu çalışmada Hukuk Mahkemelerine açılan boşanma dava sayılarının geleceğe yönelik projeksiyonunun yapılması amaçlanmıştır. Çalışma materyalini, 2013-2022 yılları arasında Adalet İstatistiklerini Derleme ve Değerlendirme Daire Başkanlığı tarafından; UYAP’ta tutulan kayıtlardan elde edilen hukuk mahkemelerine açılan boşanma dava sayısı verileri oluşturmuştur. Çalışmada dava sayılarının geleceğe yönelik tahmininde zaman serisi analizi Box-Jenkins Modeli (ARIMA) kullanılmıştır. Çalışma sonucunda dava sayılarının tahminine ilişkin en uygun model ARIMA(1,1,1)(1,1,0) modeli olarak belirlenmiştir. Yapılan tahmin sonucunda, 2023 yılında tahmin edilen dava sayısı 315.202 (%95 GA, 227.396;403.009) olarak hesaplanmıştır. Bu sonuç gerçekte açılan boşanma dava sayısını (295.187) güven aralıkları sınırları içerisinde %6,8 hata oranı ile tahmin etmiştir. Ayrıca, bu modele göre 2024 yılında 336.309 (%95 GA, 227.870;444.750), 2025 yılında 359.445 (%95 GA,229.389;489.500) dava açılacağı tahmin edilmiştir. Sonuç olarak, hukuk mahkemelerinde zaman serisi analizinin geleceğe yönelik tahminlerde kullanılabileceği ve ilgili kurumların geleceğe yönelik yapacağı planlamalarda yol gösterici olabileceği kanısına varılmıştır.*

**Anahtar Kelimeler:** ARIMA, Boşanma Davası, Box-Jenkins Modeli, Zaman Serisi Analizi

**Reference Equations and Forced Oscillation Technique - A Great Need for the Diagnosis of Pulmonary Diseases in Small Children**

**Plamena Stoimenova<sup>1\*</sup>, Stoilka Mandadzhieva<sup>1</sup>, Blagoi Marinov<sup>1</sup>**

<sup>1</sup>Medical University of Plovdiv, Faculty of Medicine, Department of Pathological physiology, 4001, Plovdiv, Bulgaria

\*Corresponding author e-mail: pstoimenova@pathophysiology.info

***Abstract***

*The diagnosis of respiratory diseases in children has always been a great challenge. The gold standard in the diagnosis of airway obstruction is spirometry, but it requires effort and is difficult to perform, especially in children. That is why in recent years FOT (forced oscillation technique) is gaining popularity due to the easy and quick implementation as well as the high sensitivity of the method. Unfortunately the systematic analysis for the reference equations used in the adult Caucasian populations around the world show a great heterogeneity and for the preschool age there is also insufficient data. The creation of reference equations requires a proper methodology, a sufficient number of healthy controls and statistical processing. Our aim is to collect a sufficient number of healthy controls under the age of 6 years, to create reference equations for the Bulgarian population and to validate the method by examining children with pulmonary diseases and comparing the results of spirometry. This work will have a significant impact on the pulmonary medicine in Bulgaria and will improve the diagnosis, treatment and control of childhood asthma.*

**Keywords:** *Forced Oscillation Technique, Reference Equations, Children*



**The Application of One-Way Anova in the Study of the Antioxidant Activity of Commercial Citrus Essential Oils**

Jelena Stanojević<sup>1</sup>, Nataša Simonović<sup>1\*</sup>, Ljiljana Stanojević<sup>1</sup>, Dragan Cvetković<sup>1</sup>, Marija Stojanović-Krasić<sup>2</sup>

<sup>1</sup>University of Niš, Faculty of Technology, 16000, Leskovac, Republic of Serbia

<sup>2</sup>University of Niš, Faculty of Medicine, 18108, Niš, Republic of Serbia

\*Corresponding author e-mail: simonovicnattasa@gmail.com

**Abstract**

The present study aimed to apply statistical analyses to evaluate the differences in antioxidant activity among commercial essential oils (mandarin, tangerine, grapefruit, pomelo, and bergamot) present in the market of the Republic of Serbia. According to the supplier's data (Avena Lab-Farmadria d.o.o. Vršac, Republic of Serbia), the essential oils (EOs) studied were isolated from the fruit peel by cold pressing. The series of EOs concentrations (1-200 mg/ml) and the DPPH radical were prepared in ethyl acetate. The antioxidant activity was determined spectrophotometrically, using the DPPH assay. The experiments were done in triplicate. Since there are two variables, one categorical (commercial citrus essential oils) and one numerical (the EC50 values), a one-way analysis of variance was performed. The EC50 values (defined as the concentration of the sample leading to a 50% reduction in the initial DPPH radical concentration), were calculated by a graphical method from a graphs showing the dependence of EOs concentrations on incubation time with the DPPH radical. The lower EC50 values indicate higher antioxidant activity in the sample. The antioxidant activity was determined after 90 minutes of incubation with the DPPH radical to include the EC50 value of all samples. Firstly, the conditions for the application of ANOVA were tested. The samples are independent and come from a population with a normal distribution. To check the equality of variance, O'Brien and Brown-Forsythe tests were used. Based on the results obtained, it was shown that there is no evidence showing statistically unequal variances between groups (0.2458 and 0.4814, respectively). A p-value obtained for ANOVA ( $<0.0001$ ) indicated that the mean value, at least between two groups of data, is statistically significantly different. In order to find out which groups exactly differ, a post hoc Tukey test was performed, which showed that all groups are statistically significantly different. Based on the Tukey-Kramer test, the antioxidant activity of commercial essential oils decreased in the following order: grapefruit > pomelo > mandarin > tangerine > bergamot. The EOs studied are weak antioxidants, with EC50 values of 15.18 mg/ml (grapefruit), 29.13 mg/ml (pomelo), 42.62 mg/ml (mandarin), 143.76 mg/ml (tangerine) and 182.71 mg/ml (bergamot) after 90 minutes incubation with the DPPH radical. The results obtained showed successful application of the one-way ANOVA in the study of antioxidant activity of different essential oils. Acknowledgements: This work was supported by the Ministry of Science, Technological Development and Innovation of the Republic of Serbia under the Program of financing scientific research work, number 451-03-65/2024-03/200133. Nataša Simonović is a Scholar of the Ministry of Science, Technological Development and Innovation of the Republic of Serbia.

**Keywords:** Essential oil, DPPH, ANOVA

**Application of Custom Design in the Determination of the Optimal Maceration Conditions and the Effect of Photoselective Nets on the Total Extractive Matter from French Marigold (*Tagetes Patula L.*) Petals**

**Nataša Simonović<sup>1\*</sup>, Marija Stojanović-Krasić<sup>2</sup>, Lidija Milenković<sup>3</sup>, Zoran Ilić<sup>3</sup>, Ljiljana Stanojević<sup>1</sup>, Dragan Cvetković<sup>1</sup>, Jelena Stanojević<sup>1</sup>**

<sup>1</sup>University of Niš, Faculty of Technology, 16000, Leskovac, Republic of Serbia

<sup>2</sup>University of Niš, Faculty of Medicine, 18108, Niš, Republic of Serbia

<sup>3</sup>University of Priština, Faculty of Agriculture, 38219, Lešak, Republic of Serbia

\*Corresponding author e-mail: simonovicnattasa@gmail. com

*Abstract*

*The aims of the present paper were to determine the optimal maceration conditions for the total extractive matter (TEM) and the effect of the photoselective colored nets on the TEM from the dwarf marigold (*Tagetes patula L.*) petals. The plant material was grown in south Serbia during 2023 in a net house covered with photoselective nets (pearl, red, and blue) and an unnetted control. For the purposes of this research, Custom Design (JMP<sup>®</sup> software by SAS) was recognized as ideal among experimental designs, giving the desired results with the minimal number of experiments. The input variables were: ethanol concentration (20% - 96%); extraction time (6 hours - 120 hours); solvomodule (plant material:solvent ratios of 1:10 m/V - 1:40 m/V) and photoselective nets. The output variable was TEM (in mg/ml). Twenty-eight runs were done. The obtained optimal conditions were as follows: solvomodule of 1:10 m/V, extraction time of 120 hours, and ethanol concentration of 47.6%. Under optimal conditions, with a 95% confidence interval, the TEM should be in the range of 17.34 mg/ml to 21.16 mg/ml, where the predicted value was 19.25 mg/ml. The Effect Test showed that the effect of the color of photoselective nets is not a statistically significant factor. The plant material grown under purple net was randomly selected, and maceration was repeated under optimal conditions. The TEM was determined gravimetrically with a value of 20.17 mg/ml, meaning that the regression model used is adequate.*

**Keywords:** *Design of experiments, maceration, *Tagetes patula L.**

**Acknowledgements:** This work was supported by the Ministry of Science, Technological Development and Innovation of the Republic of Serbia under the Program of financing scientific research work, number 451-03-65/2024-03/200133. Nataša Simonović is a Scholar of the Ministry of Science, Technological Development and Innovation of the Republic of Serbia.

**Predictive Modeling of Earnings in Thoroughbred Racehorses in Türkiye: A Multi-Class Classification Approach Using C5.0 Algorithm**

**Volkan Türkmen<sup>1\*</sup>, Doğukan Özen<sup>2</sup>**

<sup>1</sup>Ankara University, Institute of Health Sciences, Department of Biostatistics, 06070, Ankara, Türkiye

<sup>2</sup>Ankara University, Veterinary Faculty, Department of Biostatistics, 06070, Ankara, Türkiye

\*Corresponding author e-mail: volkan.turkmen@sbu.edu.tr

**Abstract**

*The ability to accurately predict and optimise the racing performance of Thoroughbred racehorses is of great importance in the equine industry, as it allows for more efficient resource allocation and the enhancement of breeding and training practices. In this context, the integration of population-oriented studies with extensive datasets represents a promising avenue for the development of robust predictive models. The objective of this study is to develop a prediction model for the earnings target attribute, utilising the multi-class classification algorithm C5.0 decision tree, with the attributes of age at start, gender, maternal, track type, ownership status, racing duration and number of starts. The data set comprised the regular records of the Turkish Jockey Club for 10,480 Thoroughbred racehorses born between the years 2010-2020 and those racing career ended as of 01 April 2022. The earnings were converted to a dollar exchange rate and divided into three categories: those who did not earn at all (n=5995), those who earned less than average (n=2243) and those who earned more than average (n=2242). A C5.0 classification algorithm was applied to create a prediction model. In order to provide a comprehensive overview of the model's performance, a range of metrics were employed, including macro averages for accuracy, balanced accuracy, precision, recall and F-measure, as well as the Matthews Correlation Coefficient (MCC). This approach was adopted in order to address the challenges posed by multi-class classification problems, where the one-versus-all binary solution is typically employed. The "caret" and "mltools" packages in the RStudio programme were employed to perform 10-fold cross-validation with 10 repetitions on the data set, which was randomly divided into an 80% training and 20% test data set. The performance metrics for the prediction model, obtained using the multi-class classification algorithm C5.0 for the three-class earning target attribute, were as follows: Accuracy (0.569, 95% CI (0.551, 0.587)), Balanced Accuracy (0.542), Precision (0.467), Recall (0.385) and F-Measure (0.356). Furthermore, the Matthews correlation coefficient (MCC) was calculated as (0.146). When the attributes comprising the prediction model were ranked according to their relative importance, the attributes were found to be the horse's racing duration, age at the start of the career, running on a single type of track, number of starts, type of track first run and maternal, respectively. These findings offer valuable insights into the determinants of success in Thoroughbred racing, facilitating informed decision-making in horse breeding and racing management practices. The findings of this research demonstrate the potential of predictive modelling in optimising resource allocation and enhancing the competitiveness of the racing industry. By employing advanced data analytics techniques, breeders, trainers, and other stakeholders can make more informed decisions to maximise the racing performance and economic viability of Thoroughbred racehorses.*

**Keywords:** C5.0 Algorithm, Classification, Earnings, Thoroughbred, Race Horse



## Circular Statistics in Ophthalmology: A Review of the Literature

Aslan Aykut<sup>1,2</sup>

<sup>1</sup>University of Michigan, Kellog Eye Center, Department of Ocular Oncology, 48105, Michigan, Ann Arbor

<sup>2</sup>Department of Ophthalmology, Marmara University Medical School, 34809, Istanbul, Türkiye

\*Corresponding author e-mail: aslanaykut81@gmail.com

### *Abstract*

*Circular statistics is a branch of mathematics that deals with the analysis of angular data, which is relevant in various fields of ophthalmology. This literature review aims to examine the current usage of circular statistics in ophthalmological research. A very comprehensive PubMed search using the Boolean operator "AND" and the search terms "circular statistics" with "ophthalmology", "retina", "cataract", "optic disc", "optic nerve", "astigmatism", "choroidal melanoma", "cornea", "strabismus", and "glaucoma" yielded 4 articles. Two articles (50%) focused on optic disc retinal nerve fiber layer (RNFL) thickness, one article (25%) discussed ultrasound biometry of the anterior segment, and one article (25%) investigated cataract surgery. The very limited number of articles indicates that the application of circular statistics in ophthalmology is extremely low, despite the suitability of the eye for this type of analysis. Further research and awareness are needed to explore and promote the potential of circular statistics in ophthalmology.*

**Keywords:** *Circular statistics, Ophthalmology, Optic disc, Cataract surgery*

**Cash Subsidy or Childcare Service: An Analysis of the Fertility Effect of European Family Policy: Based on a Multi-level Regression Model**

**Jiehua Lu<sup>1\*</sup>, Hui Zhu<sup>2</sup>**

<sup>1</sup>Department of Sociology, Peking University


<sup>2</sup>School of Sociology, Nankai University

<sup>1\*</sup>Corresponding author e-mail: [lujiehua@pku.edu.cn](mailto:lujiehua@pku.edu.cn)

**Abstract**

*From the 2009-2014 OECD Household Expenditure Database and the 2014 European Social Survey Database, this study generates a new set of integrated macro and micro data (non-longitudinal). A multi-level binomial regression model is applied to explore the impact of macro-family policies on micro-fertility decision-making in fifteen European countries. Our research emphasizes the importance of theoretical perspective and focuses on the specific policy measures that are related to the two distinctively different policy values of “family-oriented” and “de-family-oriented”. The empirical results find out that the “de-family-oriented” childcare services have a significant positive impact on the birth decisions of European families, while the “family-oriented” cash subsidies have not produced the expected significant effect. This study further examines the differential impact of family policies on different groups of people, focusing on the effects of gender, age, education, and income. The results reveal that couples of younger age or higher incomes are most affected on birth decisions by childcare services. This study also verifies the robustness of the data and introduces into the model additional variables such as the allocation ratio of childcare services and cash subsidies, their proportion in GDP, and paid leave. It reveals that childcare services and paid maternity leave form a policy synergy in promoting family reproductive decision-making to a certain extent. This suggests that the effectiveness of European family policy for promoting fertility lies on the changes in service delivery of childcare, rather than on direct cash subsidy. There is a policy implication for China’s future family policy. Our future emphasis should be placed on the institutional design and resource investment in infant and child care services.*

**Keywords:** Family Policy, Fertility Effect, Cash Subsidy, Childcare Service, Multi-Level Regression Model



**FULL TEXT  
POSTER  
PRESENTATIONS**



## Tarım Makinelerinin Güvenilirlik Göstergelerinin İstatistiksel Analiz Yöntemiyle Belirlenmesi

İsrafil İsmayılov<sup>1\*</sup>, Mustafa Kantas<sup>2</sup>

<sup>1</sup>Tarım Bakanlığı, Agroservis OJSC, Baş Danışmanı, AZ1007, Bakü, Azerbaycan

<sup>2</sup>T.C. Tarım ve Orman Bakanlığı, Ankara, Türkiye

\*Sorumlu yazar e-mail: i.israfil20@mail.ru, mustafa.kantas@tarimorman.gov.tr

### Özet

İstatistik, güvenilirlik ve olasılık teorilerinin yardımıyla, yabancı traktörlerin ve biçerdöverlerin operasyonları sırasında arızalarına ilişkin veriler analiz edilmekte ve tarım makinelerinin operasyonel güvenilirlik göstergeleri belirlenmiştir. Traktörlerdeki arızaların% 70,3'ünün, biçerdöverlerdeki arızaların% 38'inin motordan geldiği tespit edilmiştir. Biçerdöverlerin mevsimsel üretim frekanslarının normal dağılıma karşılık geldiği ve traktörlerin sorunsuz çalışma olasılığının üstel olduğu doğrulanmıştır. Traktörlerin ve biçerdöverlerin çalışma süresinin ampirik ve teorik dağılımlarının uygunluk derecesi, Kolmogorov'un kabul kriterine göre değerlendirildi. Çalışma süresi olasılığına yaklaşan yasanın ampirik fonksiyonla oldukça iyi bir şekilde tutarlı olduğu tespit edilmiştir. Arıza anında ekipmanın çalışma saatlerinin istatistiksel analizine dayanarak, biçerdöverlerin mevsimsel üretiminin 376,2 saat, traktörlerin ortalama çalışma süresinin 769,2 saat, biçerdöverlerin ortalama çalışma süresinin 540,5 saat olduğu tespit edilmiştir.

**Anahtar Kelimeler:** Tarım Makineleri, İstatistiksel Analiz, Güvenilirlik Göstergeleri, Mevsimsel Üretim, Çalışma Süresi, Çalışma Süresi Olasılığı

### Abstract

With the help of statistical theories, reliability and probability, data on failures of foreign tractors and combine harvesters during their operation are analyzed and indicators of operational reliability of agricultural machinery are determined. It was found that 70.3% of tractor failures, 38% of combine harvesters' failures are due to the engine. It is proved that the frequency of seasonal operation of combine harvesters corresponds to a normal distribution, and the probability of trouble-free operation of tractors is exponential. The degree of compliance of empirical and theoretical distributions of uptime of tractors and combine harvesters was assessed according to the Kolmogorov agreement criterion. It is established that the law approximating the probability of trouble-free operation is in good agreement with the empirical function. Based on a statistical analysis of the operating hours of the equipment at the time of failure, it was found that the seasonal output of combines is 376.2 hours, the average uptime of tractors is 769.2 hours, the average uptime of combine harvesters is 540.5 hours.

**Keywords:** Agricultural machinery, Statistical analysis, Reliability indicators, Seasonal volume of work, Uptime, Probability of uptime

### GİRİŞ

Yabancı traktör ve biçerdöverlerin Azerbaycan Cumhuriyeti şartlarında işletilmesi sırasında, yapısal eksiklikler ve işletme aksaklıkları nedeniyle işletme-güvenilirlik göstergelerinde bozulma gözlenmiştir. Bu faktörler sonuçta traktör ve biçerdöverlerin güvenilirliğinde ve tarım makinelerinin kullanım verimliliğinde keskin bir düşüşe yol açmaktadır (İsmayılov, 2007a).

Ayrıca Azerbaycan'da kullanılan çeşitli yabancı firmalar tarafından üretilen traktörlerin, biçerdöverlerin ve pamuk hasat makinelerinin güvenilirlik göstergeleri yeterince araştırılmamıştır.

Ancak yazar, bazı yabancı traktörlerin operasyonel güvenilirlik göstergelerini belirlemiş ve operasyonel arızaların türü ve niteliğine ilişkin istatistiksel verilere dayanarak bir araya getirmiştir (Ismailov, 2007b).

## MATERYAL VE METOD

Traktör ve biçerdöverlerin güvenirliliği hakkında daha detaylı bilgi elde edebilmek için güvenilirlik olasılığına dayalı minimum örneklem seçme yöntemine göre 25 traktör ve 25 biçerdöverin gözlemlenmesine karar verilmiştir (Novik, Arsov, 1980).

New Holland traktörlerinin Azerbaycandaki çalışması sırasında 25 arıza gözlemlendi. Traktörlerin çalışma süresinin arızasız dağılımının türünü ve parametrelerini belirlemek için mevcut metodoloji kullanılmıştır (6,7 Ismailov, Süleymanova, 2013).

Sampo SR-2065 (Finlandiya) biçerdöverlerin güvenirliliğini değerlendirmek amacıyla 25 adet biçerdöverin gözlemlenmesi sonucunda, çalışma sırasında ana düğüm ve mekanizmalarda 32 adet arıza tespit edilmiştir.

Amaç, traktör ve biçerdöverlerin arızaları hakkındaki bilgileri istatistik, güvenilirlik ve olasılık teorileri ve yasalara dayanarak analiz etmek ve mevcut metodolojiye göre operasyonel güvenilirlik göstergelerini, düzenliliklerini ve ilgili parametreleri belirlemektir (Novitsky, Zograf 1985).

Tekniğin iş hacminin ampirik değerlerinin dağılımının Gauss (normal) yasasına uyduğu bilinmektedir. Normal dağılımın yoğunluğu aşağıdaki ifadeyle verilmektedir (Novitsky, Zograf 1985):

$$f(t) = \frac{1}{\sigma\sqrt{\pi}} e^{-(t_i - \bar{t})^2 / 2 \cdot \sigma^2}$$

Tarım makinelerinin arızalanmadan çalışma olasılığının üstel bir dağılıma karşılık geldiği bilinmektedir. Bu metodolojiye göre arızalanmadan çalışma olasılığı ve çalışma süresinin bozulmadan dağılım yoğunluğu şu şekildedir (Ismailov, Süleymanova, 2013):

$$P(t) = e^{-\lambda^* t} ; f(t) = \lambda^* e^{-\lambda^* t}$$

Burada  $\lambda^*$  bozunma yoğunluğunun istatistiksel değeridir.

Görüldüğü gibi üstel dağılım sadece  $\lambda$  parametresi tarafından belirlenmektedir. Ani arızaların dağılımını açıklamak için uygulanan üstel dağılımın karakteristik bir özelliği,  $\lambda$  miktarının sabit olması koşuludur.

Metodolojiye göre hasar şiddeti  $\lambda^* (t_j)$  belirlendikten sonra  $\lambda_j^*$  miktarlarının nispeten stabil olduğu açıklığa kavuşturulmalı ve bu değerlerin ortalaması kabul edilmelidir.

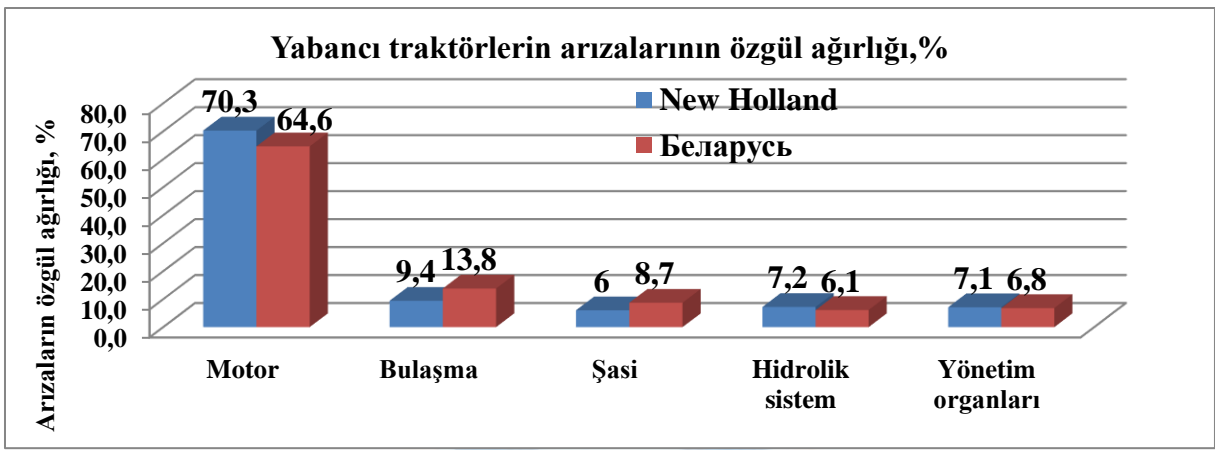
Tarım tekniğinin istatistiksel güvenilirlik göstergelerinin frekans dağılımının ampirik ve teorik fonksiyonlarının karşılaştırılması, sürecin doğru ifade edilmesi Kolmogorov'un kabul kriteri temelinde değerlendirilmektedir (Durczak ve ark. 2022):

$$\gamma = 0.1316 < 1$$

Bu koşulun sağlanması durumunda sürecin doğru anlatılabilmesi için hukuka uygunluk teyit edilmektedir.

## ELDE EDİLEN SONUÇLAR

Gözlem verilerine dayanarak, New Holland ve Belarus traktörlerinin düğümlerindeki ve sistemlerindeki arızaların özgül ağırlığı (%) şekil 1'de verilmiştir. Şekil 1'den görülebileceği gibi traktör arızalarının % 73'ü (New Holland), % 64,6'sı (Belarus) motor, % 9,3'ü (New Holland) ve % 13,8'i (Belarus) güç aktarma organlarından kaynaklanmaktadır. (şanzıman) payına, % 7,2 (New Holland) ve % 6,1 (Belarus) - hidrolik sistem payına, % 7,1 (New Holland), % 6,8 (Belarus) - yönetim organlarının payına, % 6 (New Holland), % 8,7 (Belarus) - hareketli parçalara (şase) aittir (Ismailov, 2004).



Şekil 1. Yabancı traktör arızalarının özgül ağırlığı

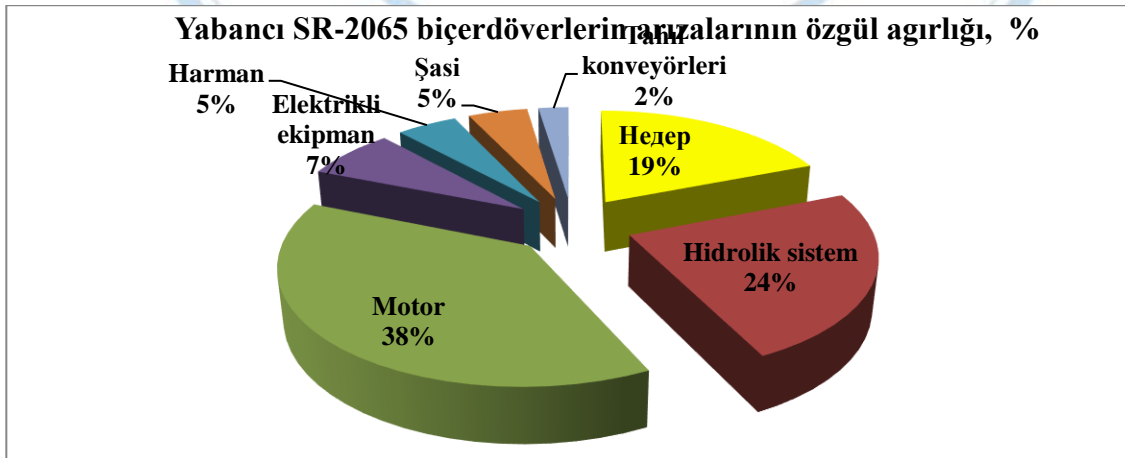
Bu istatistiksel verilere göre traktörlerin düğüm ve parçalarının güvenilirliği hakkında fikir sahibi olmak mümkündür. Ancak bu veriler traktörlerin operasyonel güvenilirlik göstergeleri hakkında detaylı ve doğru bilgi sağlayamamaktadır. Bu nedenle istatistiksel verilere dayanarak traktör ve biçerdöverlerin operasyonel güvenilirlik göstergelerinin istatistik, güvenilirlik ve olasılık teorilerine dayalı olarak belirlenmesi amaçlandı.

IVECO (New Holland) motor arızalarının analizi, arızaların % 58,3'ünün yağlama sisteminden, % 23'ünün yakıt sisteminden, % 15,4'ünün kaydırıcı mekanizmadan ve % 7,78'inin soğutma sisteminden kaynaklandığını göstermektedir (Ismailov, 2004).

Arızaların niteliğine göre traktörlerdeki arızaların % 11'inin yapısal kusurlardan, % 22'sinin ise işletme kurallarının ihlalinde kaynaklandığı sonucuna varılabilir.

Sampo SR-2065 (Finlandiya) biçerdöverlerin güvenilirliğini değerlendirmek amacıyla 25 adet biçerdöverin gözlemlenmesi sonucunda çalışma sırasında ana düğümlerde ve mekanizmalarda bulunan hasarlar gruplandırılarak resim 2'de gösterilmiştir (1, 2 Ismailov), 2007a; Ismailov, 2007b). Şekil 2'den görülebileceği gibi motor, arızaların en büyük % 38'ini oluşturmaktadır. Hidrolik sistem arızaları % 23,8, makine arızaları % 19,0, elektrikli ekipman arızaları % 7,1, hareketli parçalar ve harman ekipmanları arızaları % 5, tahıl konveyörleri ise % 2 oranındadır.

Biçerdöverlerin temel operasyonel güvenilirlik göstergelerinden biri mevsimsel iş hacmi, diğer bir deyişle tahıl hasat mevsiminde toplanan tahıl alanıdır (5, 6 Shepelev vd., 2015).



Şekil 2. Yabancı SR-2065 biçerdöverlerin arızalarının özgül ağırlığı

Sezonluk iş hacminin dağılımının türü ve parametreleri, biçerdöverlerde arıza anında motor saat göstergesine dayanan mevcut metodolojiye göre belirlendi (Novitsky, Zograf 1985).



## TARTIŞMA VE SONUÇ

Metodolojiye göre biçerdöverlerin kayıtlı motor saatleri artan şekilde düzenlenerek analiz edildi ve mevsimsel iş hacmi parametresi  $t_0=480$  saatin başlangıç değeri belirlendi. Bu noktada başlangıç anları şu şekilde tanımlanır (Ismailov, 2001):

$$a_1 = -1.2; a_2 = 3.6; a_3 = -2.4121; a_4 = 13.89.$$

Bu verilere dayanarak SR-2065 biçerdöverlerin sezonluk iş hacminin  $\bar{t}=376,2$  saat, ortalama karesel sapmanın  $\sigma=195,6$  saat, değişim katsayısının ise  $v=0,52$  olduğu tespit edilmiştir.

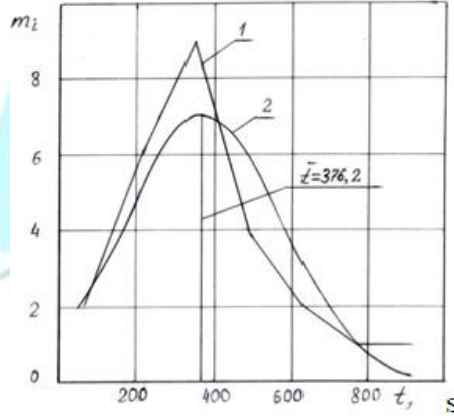
Değişim katsayısı değerine göre biçerdöverlerin mevsimsel iş hacminin ampirik değerlerinin dağılımı Gaussian (normal) ve Weibull-Gnedenko yasalarına tabi olabilir (Novitsky, Zograf 1985).

Bu yaklaşıma göre normal dağılımın yoğunluğu şu şekilde tanımlanır:

$$f(t) = \frac{1}{195,6\sqrt{\pi}} e^{-(t_i-376,2)^2/2 \cdot 195,6^2};$$

Kolmogorov'un kabul kriterine dayanarak, biçerdöverlerin sezonluk iş hacminin frekans dağılımının ampirik ve teorik fonksiyonlarının karşılaştırılması hesaplanmış, sonuç şekil 3'te verilmiştir. Rapor sonuçlarına göre biçerdöverlerin mevsimlik iş hacimlerinin dağılımının aşağıdaki parametrelerle normal bir dağılım izlediği tespit edilmiştir (Durczak ve ark. 2022):

$$\bar{t} = 376.2 \text{ saat}, \sigma = 195.6, v = 0.52$$

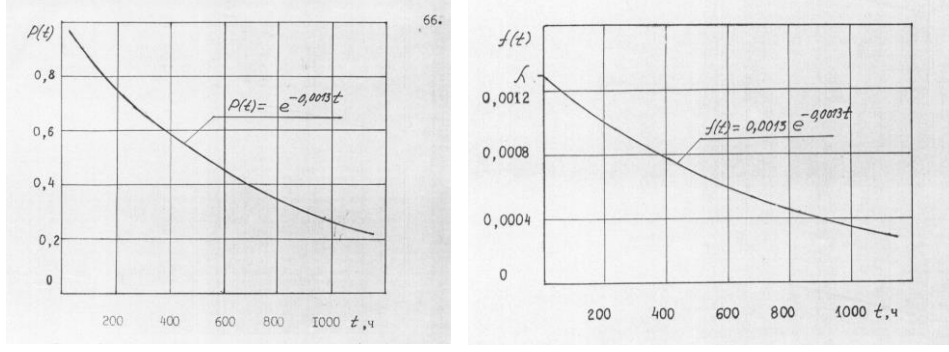


Şekil 3. SR-2065 biçerdöverlerinin mevsimsel iş hacimlerinin ampirik (1) ve teorik (2) dağılım eğrileri

Traktörlerin arıza yapmadan çalışma sürelerinin dağılım grafiği ve ani arızaların niteliğine göre, arıza yapmadan çalışma olasılığının üstel dağılıma tekabül ettiği hipotezi doğrulanmaktadır (Ismailov, Suleymanova, 2013).

New Holland traktörlerinin hasar şiddetinin  $\lambda^*=0,0013$  olduğu tespit edilmiştir. Arıza olasılığını ve arıza süresinin dağılım yoğunluğunu tahmin eden fonksiyon aşağıdaki ifadelerde ve Şekil 4'te verilmiştir:

$$P(t) = e^{-0,0013t}, \text{ ve } f(t) = 0,0013e^{-0,0013t}$$



Şekil 4. New Holland traktörlerinin  $P(t)$  arızalanmadan çalışma olasılığı fonksiyonu ve  $f(t)$  çalışma süresinin dağılım yoğunluğu

Traktörlerin arızalanma sürelerinin ampirik ve teorik dağılımları arasındaki uyum derecesi Kolmogorov'un kabul kriterine ( $\gamma$ ) göre değerlendirildi. Dolayısıyla,  $\gamma = 0.1316 < 1$  olduğundan, başarısızlık olasılığına  $P(t)$  yaklaşan yasa, şekil 4'te görülebilir; bu, ampirik  $P^*(t)$  fonksiyonuyla oldukça uyumludur.

Traktörlerin arızasız ortalama çalışma süresinin ( $T_{or}$ , saat) ile aynı olduğu ve ortalama kare sapmanın ( $\sigma$ , saat)  $T_{or} = \sigma$  ile aynı olduğu belirlenmiştir. Aynı zamanda, arızadan önceki ortalama çalışma süresi  $\lambda$  miktarının tersi olduğundan şunu yazabiliriz:

$$T_{or} = 1/\lambda = 769.2 \text{ saat.}$$

Azerbaycanda SR-2065 biçerdöverlerin çalışması sırasında 32 arıza gözlemlendi. Mevcut metodolojiye göre biçerdöverlerin çalışma süresinin arızalanma dağılımının türü ve parametreleri belirlenmiştir (Durczak ve ark. 2022).

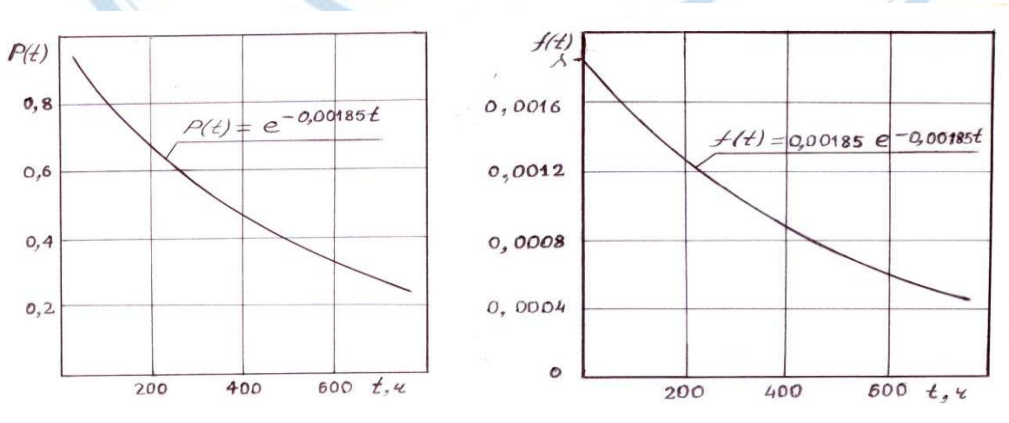
Bu sırada biçerdöverlerin arızalanmadan çalışma olasılığının ve çalışma süresinin dağılımına ilişkin teorik yasa belirlendi. Yani kombine arızaların yoğunluğu  $\lambda^* = 0.00185$  olup, arızasız çalışma süresi olasılığını tahmin eden fonksiyon aşağıdaki ifade gibidir:

$$P(t) = e^{-0,00185t} \text{ ve } f(t) = 0,00185e^{-0,00185t}$$

Dağıtım kanunu şartına göre SR-2065 biçerdöverlerin arızasız ortalama çalışma süresi

$$T_{or} = 1/\lambda = 540.5 \text{ saattir.}$$

Biçerdöverlerin arızalanmadan çalışma olasılığının  $P(t)$  fonksiyonu ve çalışma süresinin dağılımının yoğunluğu  $f(t)$  Şekil 5'te grafiksel olarak verilmektedir:



Şekil 5. SR-2065, Biçerdöverlerin arızalanmadan çalışabilme olasılığının bir fonksiyonu  $P(t)$  ve arıza süresi dağılımının yoğunluğu  $f(t)$

Şekilden görülebileceği gibi, Kolmogorov'un kabul kriterine ( $\gamma$ ) göre biçerdöverin arızasız çalışma süresinin ampirik ve teorik dağılımları arasındaki uyum derecesi aynıdır, dolayısıyla arızasız çalışma olasılığına yaklaşan yasa  $P(t)$ , ampirik fonksiyonu iyi tanımlamaktadır.

Görüldüğü gibi biçerdöverlerin sezonluk ortalama iş hacminin  $\sigma = 195.6$ ,  $\nu = 0.52$  parametrelerine sahip olduğu ve  $\bar{t} = 376.2$  saat olduğu istatistiksel analiz yöntemiyle tespit edilmiştir.

New Holland traktörlerinin arıza öncesi ortalama çalışma süresi  $T_{or} = 769.2$  saat, SR-2065 biçerdöverlerin arıza öncesi ortalama çalışma süresi  $T_{or} = 540.5$  saattir.

#### KAYNAKÇA

- Durczak K., et al. 2022. Using the Kaplan–Meier Estimator to Assess the Reliability of Agricultural Machinery. MDPI, Journal Agronomy , 12(6): 1364; Erişim adresi: <https://doi.org/10.3390/agronomy12061364>; 03.29.2024.
- İsmailov, I.I. 2007a. Biçerdöverlerin operasyonel ve güvenilirlik göstergeleri Sampo-Rosenlew. Tarımda Teknoloji Dergisi, Moskova, 6: 28-30.
- İsmailov I.I. 2007b. Ekipmanın çiftlik dışında kullanımının gerekçesi ve Tarımda hizmet işletmelerinin işleyişi. Monografi. ELM, 300, 328, Bakü, Azerbaycan.
- İsmailov I.I., Süleymanova N.M. 2013. Biçerdöverlerin hasat mevsiminde optimum kullanımına yönelik matematiksel model. Traktörler ve Tarım Makineleri Dergisi, Moskova, 6: 51-54.
- İsmailov I. I. 2001. Çiftlik (köylü) çiftliklerine yönelik teknolojik hizmetlerin istatistiksel analizi. Tarımın mekanizasyonu ve elektrifikasyonu, Moskova, 1: 30-31.
- İsmailov I.I. 2004. New Holland traktörlerinin Azerbaycan Cumhuriyeti koşullarında operasyonel güvenilirlik göstergeleri. Azerbaycan Tarım Bilimleri Dergisi, 1-3: 222-226.
- Novik F. S., Arsov Ya.B. 1980. Metal teknolojisi süreçlerinin deney planlama yöntemleriyle optimizasyonu. Erişim adresi: <https://lib-bkm.ru/13434>. Novik F.S. 1980 Deney planlama yöntemleriyle metal teknolojisi süreçlerinin optimizasyonu.djvu (yandex.ru); 30.03.2024.
- Novitsky P.V., Zograf I.A. 1985. Ölçüm hatalarının tahmini. Erişim adresi: [http://www.materialscience.ru/subjects/metrologiya/knigi/otsenka\\_pogreshnostey\\_rezultatov\\_izmereniy\\_\\_2e\\_izd\\_pererab\\_i\\_dopnovitskiy\\_p\\_v\\_zograf\\_i\\_a\\_l\\_energoatomizdat\\_leningr\\_otdnie\\_1991\\_\\_304\\_s\\_il\\_31\\_03\\_2016/](http://www.materialscience.ru/subjects/metrologiya/knigi/otsenka_pogreshnostey_rezultatov_izmereniy__2e_izd_pererab_i_dopnovitskiy_p_v_zograf_i_a_l_energoatomizdat_leningr_otdnie_1991__304_s_il_31_03_2016/); 29.03.2024.



## Statistical Analysis of Employee Punctuality Using Python

**Blerta Leka (Moçka)<sup>1\*</sup>, Kejsi Ibranj<sup>2</sup>, Marsja Beshiri<sup>2</sup>**

<sup>1</sup>Agricultural University of Tirana, Faculty of Economy and Agrobusiness Albania, Department of Mathematics and Informatics, 1025, Tirana, Albania

<sup>2</sup>Agricultural University of Tirana, Faculty of Economy and Agrobusiness Albania, Department of Mathematics and Informatics, Student, 1025, Tirana, Albania

\*Corresponding author e-mail: bmocka@ubt.edu.al

### Abstract

*Python is a highly powerful programming language that is being used in many fields and functionalities. It is a very suitable tool in the field of statistics, offering versatile abilities for data analysis, manipulation, and visualization. In this scientific research, we explore the application of Python in statistical analyses, focusing particularly on its role in examining data collected from surveys. The case study to be examined is the punctuality of employees. By utilizing Python's robust statistical libraries and methodologies, we conduct a comprehensive analysis of workforce punctuality data within the context of statistical process and quality control. Through a detailed case study of employee tardiness in an organizational setting, we utilize Python's functionalities to uncover patterns and trends in punctuality metrics. Using statistical techniques, we will identify factors contributing to employee tardiness and propose evidence-based strategies for improving punctuality. This research underscores Python's effectiveness in facilitating data-driven decision-making processes and optimizing organizational efficiency and productivity.*

**Keywords:** Python, Statistical Library, Data-driven Decision Making and Data Visualization

### INTRODUCTION

This study embarks on an exploration into the domain of data science, elucidating its profound significance in contemporary contexts and its transformative impact on strategic decision-making processes within both business and scientific spheres. Data is a very important source of information. Their collection and storage can be used to anticipate business trends, solve difficult problems, and gain a competitive advantage in changing markets. The study of business and company data significantly aids in decision-making. These studies can enhance not only daily work performance procedures but also the efficiency and punctuality of employees. Presenting data in the most suitable visual format communicates much more information and knowledge. Data visualization itself has progressed considerably, closely connected with technological advancements. It is important in businesses, organizations, institutions, medicine, science, and more. Figure 1 shows how the much-discussed and developed machine learning AI technology is driving this progress, creating automated insights and advanced visual representations.



**Figure 1** Evolution of Data Visualization

There are many tools for analyzing data. Python is a dominant force in data science, surpassing competitors like SAS and R (Data Sciences, 2022). Python offers efficiency, ease of use, and extensive

community support.

According to the 2020 survey by Burch Works, Python is the preferred tool for data scientists and analytics professionals across various demographics and industries. Python added as an option on 2016.

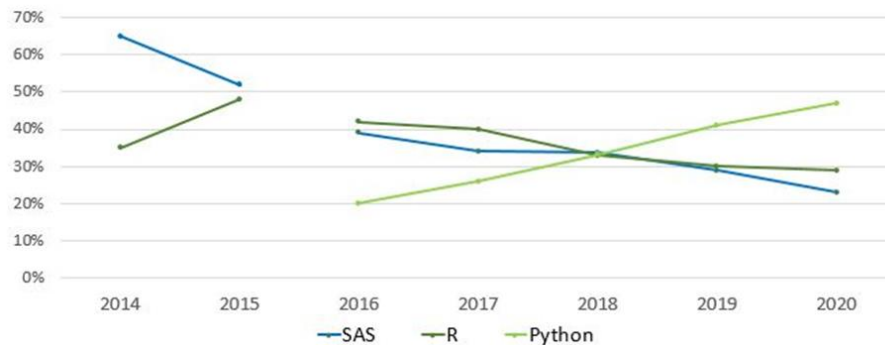


Figure 2 SAR, R or Python Preference: 7-years Trend (Brutch Works, 2020)

## DATA VISUALIZATION WITH PYTHON

The Python language is a clear choice for data visualization. Its features, such as ease of learning, a large number of libraries, extensive customization options, and a large community of developers, make it highly usable and efficient. Some of the most important libraries are NumPy, Pandas, Matplotlib, and Seaborn. These libraries provide various tools that make it easy to create everything from simple charts to complex statistical graphs. Table 1 lists several Python key libraries that make it powerful for data visualization (Ali, 2022; Zabolocki, 2022; Kmetz, 2024):

Table 1. Library of Python for data visualization

Library	Explanation	Example of Use	Main Components of Code
<b>NumPy</b>	NumPy is a library for numerical operations in Python. It efficiently handles large arrays and matrices, making mathematical and logical operations fast and easy.	Calculate total sales for each product from daily sales figures represented as arrays.	import NumPy as np # Define arrays representing daily sales figures for products #Use NumPy functions to perform calculations on arrays (e.g., np.sum for total sales).
<b>Pandas</b>	Pandas is a library for data manipulation and analysis. It provides DataFrames, which are like tables in a database, facilitating data cleaning, filtering, and analysis.	Filter data for a specific product and calculate total sales for each day from a CSV file containing sales data.	import Pandas as pd #Read CSV file into a DataFrame # Filter DataFrame based on product #Group by date and sum sales.
<b>Matplotlib</b>	Matplotlib is a library for creating various types of plots. It supports static, animated, and interactive visualizations. (Matplotlib)	Create a line chart to visualize daily sales trends with dates on the x-axis and sales amounts on the y-axis.	import Matplotlib.pyplot as plt #Define dates and corresponding sales figures #Use plt.plot to create line chart #Customize plot labels, title, and appearance. #Display plot with plt.show().
<b>Seaborn</b>	Seaborn is a library for creating visually appealing and informative statistical visualizations, building upon Matplotlib.	Create a scatter plot with a trend line to visualize the relationship between sales and advertising spend.	import Seaborn as sns #Create DataFrame with sales and advertising spend data #Use sns.regplot to create scatter plot with trend line #Customize plot labels, title, and appearance #Display plot with plt.show().

This large number of libraries facilitate our work in collecting, storing and visualizing data to generate more information from them and their statistical processing.

## **Study Overview**

This study investigates Python's efficiency in HR management through the analysis of employee punctuality data. Factors such as childcare responsibilities, pet ownership, and transportation methods are considered. Data was collected via a structured questionnaire using Google Forms, a graphical user interface (GUI), and Excel. Punctuality of employees is a feature that businesses and companies value (Smith, 2022). Using statistical analysis, this study aims to understand the various factors that affect punctuality in the workplace. Data on punctuality metrics, such as the frequency of delays and the reasons behind them, were collected through a detailed questionnaire distributed online and a survey conducted for the month of April. Using Python's powerful statistical tools, this study aims to transform raw data into valuable insights that can guide strategies for improving punctuality and optimizing organizational operations. The respondents did not have an electronic system to record their time of arrival at work.

Our goal in the study was to have real and stored data so that we could analyze it. Utilizing the wide distribution of digital platforms, structured questionnaires were distributed to gather comprehensive insights into the dynamics of employee punctuality. This ensured a large number of respondents in the Albanian capital. These questionnaires covered a wide range of variables, ranging from the frequency of delays to the factors that cause them. By adopting a standardized approach to data collection, digital platforms ensured reliability and validity in study findings, thereby strengthening the power of subsequent analyses. Furthermore, systematic data collection through digital platforms eliminated the logistical limitations of traditional data collection methods, ensuring a simple and efficient data collection process.

To gather comprehensive data on employee punctuality, a detailed questionnaire was designed. Key questions included:

- Frequency of lateness in the past month
- Main reasons for being late (e.g., childcare issues, traffic congestion, distance to work, oversleeping, personal appointments)
- Management of workload and pressure to meet deadlines
- Commute method and typical commute time
- Impact of unforeseen delays on punctuality
- Satisfaction with work-life balance

## **ANALYSIS AND RESULTS**

Visual aids provide the right connection between data and actionable knowledge, eliminating repetitive and tedious work. In this study, we used the Matplotlib and Seaborn libraries. Seaborn is a powerful Python library built on top of Matplotlib. With its elegant aesthetics and intuitive functionality, the library has gained popularity among data enthusiasts and professionals alike (DataBaseCamp, 2023). Simplified syntax and optimized defaults for creating visually appealing plots quickly. Integration with Pandas and NumPy, making it convenient for working with structured data (Lodhi, 2024).

Time series graphs, histograms, and heat maps serve as the canvas on which these insights are etched, providing multiple lenses to understand the underlying dynamics that govern employee punctuality. Statistical analyses, including factor analysis and regression modeling, further enrich the analytical landscape, shedding light on the complex interplay of variables and informing evidence-based interventions to improve accuracy.

The descriptive statistics provide a summary of key metrics related to employee punctuality. Table 2 show cases some of the primary statistics for the dataset:



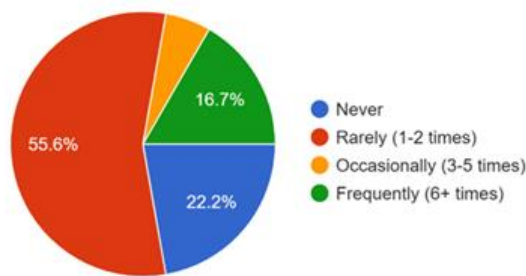
**V. International Applied Statistics Congress (UYIK - 2024)**  
**İstanbul / Türkiye, May 21-23, 2024**

**Table 2.** Descriptive Statistics

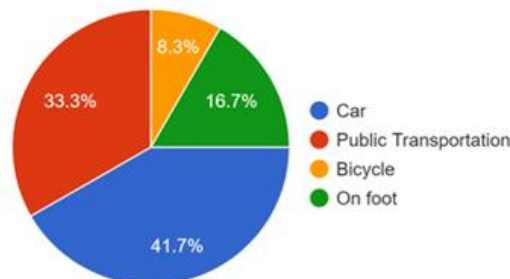
	Mean:	Standard Deviation:	Median:	Maximum:
<b>Years with Company</b>	4.91	5.49	3.0	23.0
<b>Typical Commute Time (Minutes)</b>	29.17	14.73	30.0	70.0

*Percentage of time late in the last month*

In Figure 3 are shown the percentages of being late in last month, April and in Figure 4 the methods used of commuting to work. These percentages highlight notable trends in punctuality among respondents during April. The relatively high percentage of respondents reporting rare instances of tardiness (55.6%) suggests a prevalent occurrence of occasional delays in their schedules. Conversely, the lower frequencies of frequent lateness (16.7%) and complete punctuality (22.2%) indicate a notable variance in individuals' time management practices.



**Figure 3** Percentage of being late in April



**Figure 4** Method of commuting to work

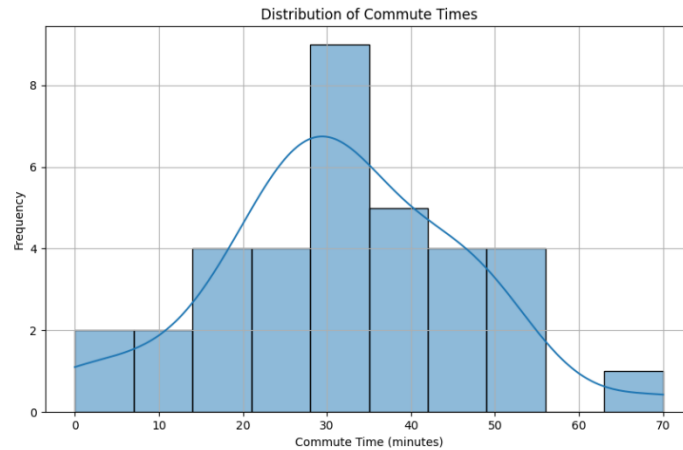
*Distance from Work*

In the analysis, one of the data that has been collected is absenteeism from the workplace due to the impact it has on the delay in arriving on time. Python code shows how to analyze and visualize travel times using descriptive statistics and a histogram.

The code in Python:

```
import pandas as pd
import matplotlib.pyplot as plt
import seaborn as sns
import pandas as pd
data = pd.read_excel('ResponseUyik.xlsx')
commute_times = data['Commute Time (minutes)']
commute_time_series = pd.Series(commute_times)
commute_time_stats = commute_time_series.describe()
print(commute_time_stats)
# Visualization using a histogram
plt.figure(figsize=(10, 6))
```

```
sns.histplot(commute_time_series, bins=10, kde=True)
plt.title('Distribution of Commute Times')
plt.xlabel('Commute Time (minutes)')
plt.ylabel('Frequency')
plt.grid(True)
plt.show()
```



**Figure 5** Distance from work in minutes

Understanding the basic characteristics of the data is crucial for any analysis. Below is a Python code snippet that calculates descriptive statistics for two important variables: "Years with Company" and "Typical Commute Time."

```
import pandas as pd
years_with_company_data = [list of data]
commute_time_data = [list of data]
years_with_company_series = pd.Series(years_with_company_data)
commute_time_series = pd.Series(commute_time_data)
years_with_company_stats = years_with_company_series.describe()
commute_time_stats = commute_time_series.describe()
print(years_with_company_stats)
print(commute_time_stats)
```

### Factor Analysis

In this paper, we conducted a study on the impact of key factors on the balance between work and life across various professions represented by our respondents. Factor analysis was employed to identify influential data pertaining to unforeseen delays, work-life satisfaction, and workload impact. Data were collected from different companies and employees across various departments to gauge their perceptions on unforeseen delays, work-life balance, and workload impact. It is important to note that 80% of the respondents did not have electronic systems tracking their work arrival times. Categorical responses were coded and analyzed using factor analysis with varimax rotation.

Factor analysis was carried out to uncover the underlying structure of the survey data. The Python programming language, along with the `factor_analyzer` library, was utilized for this purpose. Factor analysis is a statistical method employed to identify latent variables, or factors, explaining patterns of correlations among observed variables. In our study, we aimed to unveil latent factors representing different aspects of employees' perceptions regarding unforeseen delays, work-life balance, and workload impact.

The code of the necessary library for factor analysis in Python:

```
import pandas as pd
from factor_analyzer import FactorAnalyzer
import matplotlib.pyplot as plt
import numpy as np
from sklearn.preprocessing import LabelEncoder
# Data preprocessing
data = { ... } # the dataset source
df = pd.DataFrame(data)
label_encoder = LabelEncoder()
df_encoded = df.apply(label_encoder.fit_transform)
# Factor analysis with varimax rotation
fa = FactorAnalyzer(rotation='varimax')
fa.fit(df_encoded)
# Get factor loadings
factor_loadings = pd.DataFrame(fa.loadings_, index=df.columns)
```

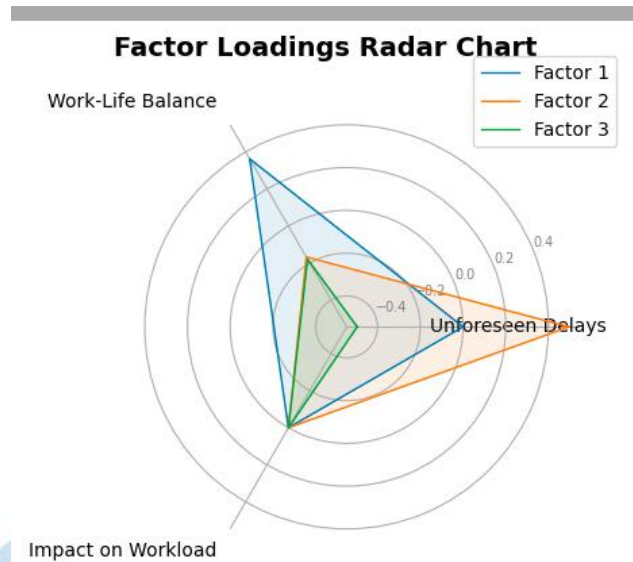
To visualize the factor loadings obtained from factor analysis, we employed a radar chart. This type of chart is particularly useful for displaying multivariate data in a two-dimensional space, allowing us to compare the relative strengths of each factor across different variables.

```
plt.figure(figsize=(8, 8))
labels = df.columns
num_vars = len(labels)
angles = np.linspace(0, 2 * np.pi, num_vars, endpoint=False).tolist()
# Plot each factor loading
for i, (index, row) in enumerate(factor_loadings.iterrows()):
    ax = plt.subplot(111, polar=True)
    ax.plot(angles, np.append(row.values[:-1], row.values[0]), linewidth=1,
linestyle='solid', label=f'Factor {i + 1}')
    ax.fill(angles, np.append(row.values[:-1], row.values[0]), alpha=0.1)
# Customize the radar chart appearance
plt.gca().spines['polar'].set_visible(False)
plt.xticks(angles[:-1], labels, ha='right')
plt.yticks(color='grey', size=7)
plt.title('Factor Loadings Radar Chart', fontsize=14, weight='bold',
loc='left', pad=20)
plt.legend(loc='upper right', bbox_to_anchor=(1.1, 1.1))
plt.show()
```

The visualization code is presented along with the factor loadings obtained from the analysis. This helps readers understand the process and interpret the results effectively (Figure 5).

Our findings underscore the multifaceted nature of work-life balance, influenced by factors such as unforeseen delays, satisfaction levels, and workload impact. Understanding these underlying dimensions can inform organizational strategies aimed at enhancing employee well-being and productivity. Python's extensive libraries, such as Pandas, NumPy, and Matplotlib, make it an excellent tool for data analysis and visualization, enabling users to clean, analyze, and present data effectively.





**Figure 6.** The output of factor analyses

In today's digital world, Python's capabilities are crucial for unlocking the potential of big data, driving informed business decisions and innovations (Crabtree & Nehme, 2023).

## CONCLUSIONS

The use of Python for statistical analysis is becoming increasingly widespread. While R may remain preferred for mathematicians, the ease with which students can learn Python and its application for data visualization motivated us to conduct this study on a large dataset. Python has numerous libraries that assist with comprehensive statistical analysis. Additionally, it has suitable libraries for data visualization.

As organizations continue to generate and harness the power of data to gain a competitive advantage, Python remains a well-suited language for turning information into knowledge.

Our conclusion of study:

- We utilized Python to analyze data on employee punctuality, revealing significant factors such as childcare responsibilities, pet ownership, and transportation methods.
- Python proved to be an efficient tool for handling large datasets and performing complex analyses.
- Addressing the identified factors can improve employee punctuality and overall efficiency.
- The study highlights the importance of data-driven decision-making in workplace management.

Benefits of using Python:

- Efficiency: Python simplifies data manipulation and analysis with its robust libraries like Pandas and NumPy.
- Versatility: Suitable for various types of data analysis and statistical computations.
- Visualization: Libraries such as Matplotlib and Seaborn allow for clear and insightful data visualization.
- Resources: Extensive documentation and a supportive community provide valuable resources for learning and troubleshooting.
- Integration: Python seamlessly integrates with other tools and platforms, enhancing its utility in data science.

## References

Ali, M., 2022, "Top Python Libraries for Data Science in 2022", <https://www.datacamp.com/blog/top-python-libraries-for-data-science>

- Burtch Works, 2020, "2020 SAS, R, or Python Survey Results: Which Tool do Data Scientists & Analytics Pros Prefer?", <https://www.burtchworks.com/industry-insights/2020-sas-r-or-python-survey-results-which-tool-do-data-scientists-analytics-pros-prefer>
- Crabtree, M. & Nehme, A., 2023, "What is Data Analysis? An Expert Guide With Examples", <https://www.datacamp.com/blog/what-is-data-analysis-expert-guide>
- DataBaseCamp, 2023, "What is Seaborn?", <https://databasecamp.de/en/python-coding/seaborn-en#:~:text=Seaborn%20is%20a%20Python%20data%20visualization%20library%20that,for%20creating%20aesthetically%20pleasing%20and%20informative%20statistical%20graphics.>
- Data Science, 2022, "Which Machine Learning Language? Analyzing R vs. Python", <https://www.thedataincubator.com/blog/2022/08/19/python-vs-r/>
- Franklin, Ch. 2023, "Data Visualization in Python: Matplotlib, Seaborn, and Plotly", Weekly Python, Data Visualization in Python: Matplotlib, Seaborn, and Plotly | by Christopher Franklin | Weekly Python | Medium
- Kmetz, R., 2024, Unleashing the Power of Python: Exploring the Best Data Visualization Libraries, Publish on: Jan 9, 2024, <https://ryankmetz.medium.com/unleashing-the-power-of-python-exploring-the-best-data-visualization-libraries>
- Lodhi, K. 2024 "Exploring data visualization: Matplotlib vs. Seaborn, educative.io Matplotlib, Getting started — Matplotlib 3.9.0 documentation
- Montgomery, D. C. (2017). "Design and Analysis of Experiments." John Wiley & Sons.
- OpenAI. AI Language Model 3.5. <https://openai.com/language-models>
- Smith, J. (2020). "Employee Absenteeism: Causes, Consequences, and Solutions." Harvard Business Review.
- Zabolocki, M., 2022, "Top Python Libraries for Visualization: A Starting Guide; The guide to plotting scatter plots, heat maps, ridgeline plots and line graphs in Python", Publish on: Jan 1, 2022, <https://towardsdatascience.com/top-python-libraries-for-visualization-a-starting-guide-73402178811b>

#### **Conflict of Interest**

The authors have declared that there is no conflict of interest.

#### **Author Contributions**

Blerta Leka (Moçka): Supervision, execution, and refinement of the research, including conceptualization, methodology design, data collection, analysis, interpretation, and manuscript composition.

Kejsi Ibranj and Marsja Beshiri: Contribution to the study's inception, particularly focusing on parents' commuting experiences. Active involvement in data collection and analysis.

## Using Statistical Methods and Artificial Intelligence for Chronological Attribution in Archeology

**Oscar Trull<sup>1</sup>, Joaquín Jiménez-Puerto<sup>2</sup>, Blanca Pérez-Aguilar<sup>3</sup>, Francisca Sempere-Ferre<sup>1</sup>**

<sup>1</sup>Universitat Politècnica de València, Department of Applied Statistics, Operational Research and Quality, E-46022, Valencia, Spain

<sup>2</sup>Universitat de València, Department of Archeology, Postal Code, Valencia, Spain

<sup>3</sup>Universitat Politècnica de València, E-46022, Valencia, Spain

\*Corresponding author e-mail: otrull@eio.upv.es

### *Abstract*

*The arrangement of the finds and the diversity of their locations poses a problem for the chronological attribution of superficial archaeological collections. This is a process of great uncertainty and difficulty. The need for indirect dating makes its attribution even more complicated.*

*The use of statistical methods and artificial intelligence in this field is relatively new, but has great potential. The use of Machine Learning is allowing us to overcome barriers that traditional models cannot resolve.*

*In this article we present the process carried out to determine the chronological attribution to various archaeological packages of the Valencian Community. To achieve this, classification techniques have been tested; from a set of archaeological levels with well-known chronologies, which contain arrowheads, it has been possible to determine the dating of other sets of initially indeterminate chronology.*

**Keywords:** *archeology, statistics, machine learning*

### **INTRODUCTION**

Archaeological materials are generally classified typologically. The difficulty in establishing relationships or understanding their possible cultural or chronological meaning is very high, with those cases in which there is no associated C14 dating being especially sensitive. In these cases – which represent almost 80% of the data to be treated in this work – it is of great interest to have a scientific method that allows these archaeological collections to be associated with a specific chronological period. Therefore, in order to establish a methodology, statistical proposals based on the experience of other sources have been used in recent years, and which can be related to the archaeological objects to be dated.

Within the working group, bayesian tools have already been used that offer great results (Armero et al., 2020; Pardo-Gordó et al., 2022), although they are not free of problems, often derived from the nature of the data itself.

In this work, an approach is made to the use of techniques from Machine Learning, for chronological attribution of archaeological contexts lacking radiocarbon determination, using artificial intelligence (AI), exploring its classifying and predictive potential. AI-based methods are used for a multitude of tasks, although their use in the archaeological discipline is still incipient and is far from representing a homogeneous corpus. Usually they are focused on analysing images for classifications (Aprile et al., 2014; Caspari & Crespo, 2019). We apply artificial neural networks (ANN) to date archaeological undated objects. Other methods are also applied to test results.

The set to process consists of typological data of bifacial lithic arrowheads associated with the 3rd and 4th millennium cal BC. These arrowheads are characterized in 7 groups depending on the shape.

The article is organized as follows: A section regarding materials and methods will analyse the methodology; results are shown in the results section, and finally, the discussion and conclusion in the last section.



## MATERIAL AND METHODS

### Material

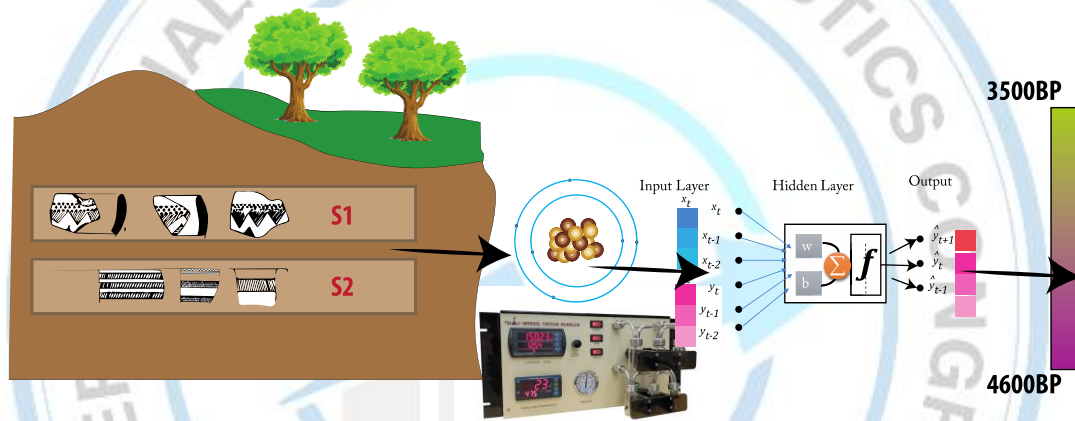
The data set included in this article consists of the chronology of the archaeological levels of an a priori set covering radiodeterminations from 4600 to 3500 BP (uncalibrated). Data reflects counts of arrowheads located on the locations.

This set consists of only 55 units and has been used to generate the artificial intelligence models. Of this set, a subset was used to train the methods, while another subset (15%) was used for validation and testing. The target was to date a total of 280 objects undated.

### Methods

#### *The Collection of the Data*

The first phase consists of the collection of archaeological information, mainly from bibliographic funds, from sites located in the Júcar and Segura hydrographic basins, for subsequent typological classification (See Figure 1). Many come from archaeological excavations, but a large number come from clandestine searches or from unclear contexts chronologically speaking.



**Figure 1.** Processes for obtaining chronological attribution.

The second phase consists of determining the age of those archaeological levels from which short-lived radiocarbon dating can be extracted. This set of dates is obtained in various locations and different strata, with a great variety of possibilities (mainly seeds or bones). This set is what will serve as the basis for the generation of the models, and has been called a priori set. For this task, the joint work between the statesman and the archaeologist is very important. The statistician must provide a mathematical view of the data obtained, while the archaeologist provides his experience and is the one who, when faced with an inference, will determine the dating of a set.

The dating process has consisted of classifying the archaeological objects (arrowheads of 7 types) into 5 specific phases. These phases have been agreed upon by the archeology team of the Universitat de València, and have been validated by another group of archaeologists. If any object is unclassifiable, it has been removed from the a priori dataset. The count of components of the a priori dataset is shown in Table 1.

**Table 1.** Count number of arrowheads of types 1 to 7, assigned to a date phase.

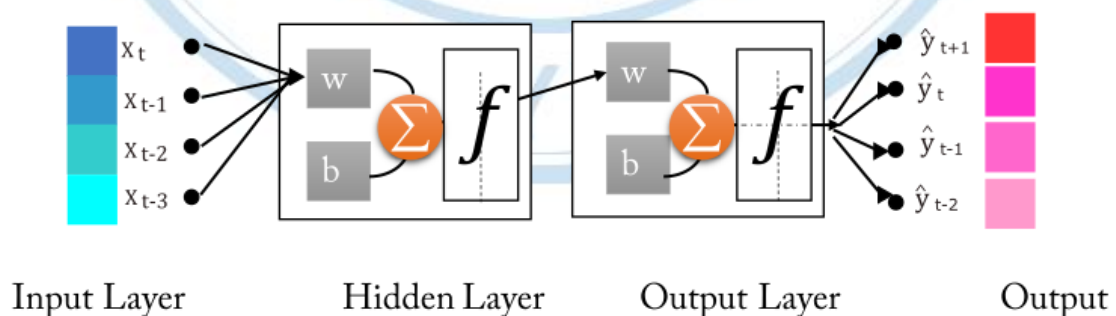
	Phase 1	Phase 2	Phase 3	Phase 4	Phase 5
Type 1	7	6	7	2	0
Type 2	11	6	1	0	0
Type 3	13	4	11	2	0
Type 4	4	2	13	6	0
Type 5	0	0	23	4	0
Type 6	1	0	0	0	0
Type 7	0	0	14	38	3

From these data, a statistical analysis has been carried out on the data to assign the dates to a subsequent set of validation data. Finally, a dating has been assigned to the objective set of undated archaeological objects.

### Statistical Analysis

To carry out the analysis, classification methods based on machine learning included in MATLAB through the Classification Learner have been used. The Classification Learner tool facilitates the application of diverse classification methods. Decision Trees (Quinlan, 1986) utilize hierarchical structures to partition data based on feature values. Support Vector Machines (SVM) construct hyperplanes to separate classes in high-dimensional space (Cortes & Vapnik, 1995). k-Nearest Neighbors (k-NN) classify data points based on proximity metrics to their nearest neighbors (Cover & Hart, 1967). Ensemble methods like Random Forests (Breiman, 2001) and AdaBoost (Friedman, 2001) combine multiple classifiers to enhance predictive performance. These methods have been extensively studied and applied across diverse domains, with research validating their effectiveness in numerous studies. Classification Learner empowers users to efficiently leverage these algorithms for various classification tasks.

However, the main analysis was carried out using neural networks (NN) whose results were compared with the models listed above. The analysis carried out consisted of the use of a swallow neural network. Neural networks allow complex classification and regression problems to be solved, based on training and selection of hyperparameters (which define the structure of the neural network). Figure 2 shows the type on neural network used in this work, a swallow neural network.



**Figure 2.** Swallow neural network. The neurons are organized in layers and interconnected through weights.

Equation (2) encapsulates the mathematical framework of the neural network model, depicting how predictions  $\hat{y}_{t+1}$  are derived based on a series of input variables  $x_t$  and bias  $b$ .

$$\hat{y}_{t+1} = f[x_t, x_{t-1}, \dots, x_1] + b \quad (2)$$

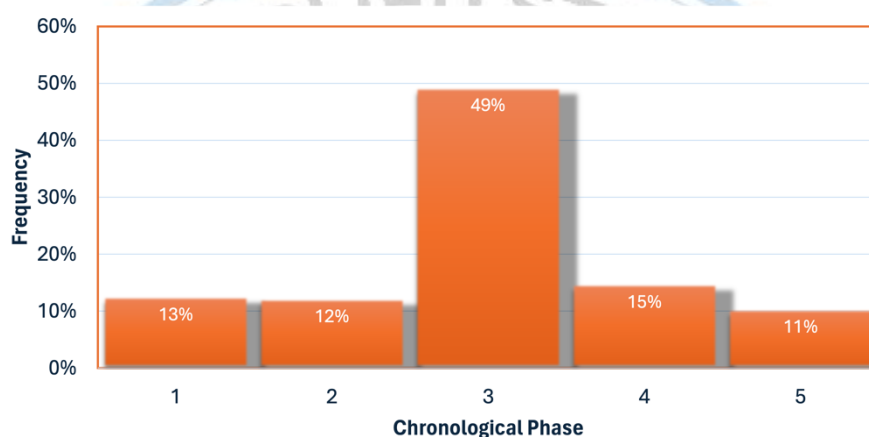
The neural network operates by connecting neurons according to specific axioms, with each connection characterized by weights  $w_i$  determined during the training process. These connections are integrated using an activation function  $f(\cdot)$  along with an aggregation function  $\Sigma(\cdot)$ .

The training of the NN is carried out using the Mean Square Error (MSE) as a metric to determine the error made. And to select the hyperparameters of the network, and compare between them, the Root Mean Square Error (RMSE) was used.

The network used consists of 7 variables and 3 hidden layers, of size 38, 12 and 233 whose activation function was used is  $\tanh(\cdot)$ .

## RESULTS

The network was validated with a set reserved specifically for this purpose, and thus, predictions were made for the undated archaeological packages and for which no C14 dating is available. The distribution of allocations is shown in Figure 3.



**Figure 3.** Distribution of the assigned chronological phases by the NN method.

The distribution obtained is expected, since the central phase predominates in the findings found. This is a phase that is also in transition from the oldest to the most modern. To contrast the results obtained, predictions were made using other machine learning methods, and the results were analyzed comparatively with those proposed with the NN. Table 2 shows the summary of these results.

**Table 2.** Comparison of dating proposals made with machine learning methods.

	Same prediction		Coincidences
All methods	30%	Tree	32%
At least 3	34%	SVM	36%
At least 2	0%	Boost	32%
None	36%		

It can be seen that in 30% of cases all prediction methods obtained the same result, and in 34% at least three methods coincided with the prediction. Of the methods used, the one that most often produced predictions similar to those proposed by the NN were the SVMs.

## DISCUSSION AND CONCLUSION

The use of artificial intelligence to make chronological attributions of archaeological levels lacking it allows us to incorporate a large number of elements into subsequent analyzes from a few measurements made with radiocarbon methods. In this article we have used regression and classification methods to date a set of almost 300 units from a small one of just 50. In the future it is intended to continue refining the method, which is in an initial phase, which would allow the samples used in archaeological analyzes



to be substantially expanded, thanks to the incorporation of contexts from excavations lacking reliable dating.

The results show that this methodology can have a strong impact on the way new elements are attributed chronologically. These conclusions are only effective for this given assemblage, but in the future they can be extended to larger assemblages and to other elements of archaeological material culture such as ceramics or metal artifacts.

### References

- Aprile, A., Castellano, G., & Eramo, G. 2014. Combining image analysis and modular neural networks for classification of mineral inclusions and pores in archaeological potsherds. *Journal of Archaeological Science*, 50, 262–272. <https://doi.org/https://doi.org/10.1016/j.jas.2014.07.017>
- Armero, C., García-Donato, G., Jimenez-Puerto, J., Pardo-Gordó, S., & Bernabeu, J. 2020. Bayesian classification for dating archaeological sites via projectile points.  *SORT*, 45(1), 33–46.
- Breiman, L. 2001. Random forests. *Machine Learning*, 45, 5–32.
- Caspari, G., & Crespo, P. 2019. Convolutional neural networks for archaeological site detection – Finding “princely” tombs. *Journal of Archaeological Science*, 110, 104998. <https://doi.org/https://doi.org/10.1016/j.jas.2019.104998>
- Cortes, C., & Vapnik, V. 1995. Support-vector networks. *Machine Learning*, 20, 273–297.
- Cover, T., & Hart, P. 1967. Nearest neighbor pattern classification. *IEEE Transactions on Information Theory*, 13(1), 21–27.
- Friedman, J. H. 2001. Greedy function approximation: a gradient boosting machine. *Annals of Statistics*, 1189–1232.
- Pardo-Gordó, S., Aubán, J. B., Jiménez-Puerto, J., Armero, C., & García-Donato, G. 2022. The chronology of archaeological assemblages based on an automatic Bayesian procedure: Eastern Iberia as study case. *Journal of Archaeological Science*, 139, 105555. <https://doi.org/https://doi.org/10.1016/j.jas.2022.105555>
- Quinlan, J. R. 1986. Induction of decision trees. *Machine Learning*, 1, 81–106.

### Acknowledgment

The authors thank the Department of Education, Culture and Sports of the Generalitat de València for funding the NeoNetS project “A Social Network Approach to Understanding the Evolutionary Dynamics of Neolithic Societies (C. 7600-4000 cal. BP)” (Prometeo/ 2021/007).

### Conflict of Interest

The authors have declared that there is no conflict of interest.

## Statistical Analysis of Tourism Investments in Balkans

Panagiotis Tzavaras <sup>1\*</sup>, Vasileios Baratsas <sup>2</sup>

Ph.D., Department of Business Administration, European University of Cyprus, Cyprus  
MBA, Department of Business Administration, European University of Cyprus, Cyprus

\*Corresponding author

### Abstract

*The Balkan region has proved to be a controversial territory. Through a long history and many controversies, the area rose to a popular destination. Common and uncommon elements make it a unique destination. Tourism has provided a sustainable source of revenue, as in every destination. Public investments are an important element of every activity to flourish and to bring private investments. Through public investments in infrastructure, superstructure, and education, we can provide a better tourist experience. In our paper, we discuss 5 countries of the region, Greece, Serbia, Bulgaria, Montenegro, and the Republic of North Macedonia. All of these destinations drew the attention of other countries and investment institutions like China and Russia. To take a look at public investments and tourism development, we compare core national accounts like the Gross Domestic Product (G.D.P.), Gross Capital Formation (G.C.F.), Gross Fixed Capital Formation (G.F.C.F.), and the inbound tourism at under investigation countries. Data indicate that there was a slowdown in each country's economy during COVID-19 but then the production increased (Gross Domestic Product (GDP)). The Gross Capital Formation (G.C.F.) has a stable rate for the first years and then increases for each country. Data for the Gross Capital Formation (G.C.F.) for the tourism industry exist only for Bulgaria and show a decrease and a negative Gross Capital Formation (G.C.F.) indication that assets must have been sold. Data for the Gross Capital Formation (G.C.F.) for the transport equipment and total construction have fluctuations without extreme increases or decreases, showing a stable rate of asset accumulation. The findings from the research conclude that till COVID-19 all the economies had a stable rate of growth, and the decrease in tourism activity had a small impact on the decrease of Gross Domestic Product (GDP), except Bulgaria all the other economies slowed down during COVID era, Gross Fixed Capital Formation (G.F.C.F.) for Montenegro and North Macedonia remained stable for the period under study in contrast of the rest countries that were exhibiting a rise from time to time, the general Gross Capital Formation (G.C.F.) accounts always indicate growth in contrast to sectional accounts as they the total accumulated investments or production. Finally, there is insufficient data for the Gross Fixed Capital Formation (G.F.C.F.) for hospitality and tourism which does not allow the researchers to make any assumption with robust data for either the investments or the capital that occurred in other to be invested in the future.*

**Keywords:** Investments, Government, Statistic, Balkans, Tourism

### 1. Introduction

#### 1.1 Tourism in the Balkan region

After the COVID-19, a handful of destinations are replanning their tourism concept to survive and make the transition to the new tourism era with numerous countries opening their international tourism borders opposing other countries that were restricting inbound tourism as the COVID-19 patients had risen (Nientied & Shutina, 2020). Western Balkan region should also reconsider the plan that the countries have for the incoming tourists in the future (Nientied & Shutina, 2020). The Balkan region is a contemporary inviting destination for vacation. Due to its rich history and as a crossroad of cultures, the Balkans attract tourists (Cvetkoska & Barisic, 2017).

Common culture and lifestyle elements exist in everyday life. The present lifestyle comes to meet the history. Wars, re-built cities, and history co-exist for the modern tourist. Thus, between each country, only territory and uncommon elements of life wait for the tourist to unravel them during their vacation. Those controversies make the Balkans a great destination (Tomka, 2014). A destination should co-plan

and cooperate on a common tourism portfolio or view the area as a single destination and promote tourism (Selimi et al., 2017). As Nawaz & Hassan (2016) state 'Tourism has long been considered as a way of enhancing understanding and peace among nations' because it received much attention as a viable solution for employment (as developing countries use tourism as a mitigation tool for poverty and unemployment (Nguyen et al, 2020; Cvetkoska & Barisic, 2017)) and tourism is a source of yield and revenue to the developed countries (Selimi et al., 2017). As we see the tourism sector has been disrupted in order to advance and support the needs of other sectors that abide by basic human needs (Nientied & Shutina, 2020). This might lead to losses for the economic development of each country. Major destinations to visit are Greece, Montenegro, Serbia, Bulgaria, and the Republic of North Macedonia.

### **1. 2 Geopolitical review of the importance of the Balkan region**

Regional cooperation in the Balkans enhances the coherence of the area both by law and economic aspects (Levitin & Sanfey, 2018; Cotella & Berisha, 2019). Tourism development has occurred greatly throughout history (Tomka, 2004). A great amount of funds has been and will be spent to advance the infrastructure in the region (Cotella & Berisha, 2019).

The connectivity in the western Balkan region is uneasy due to the restrictions and the border crossing customs that are utilised by each country, making it difficult for tourists to explore the area (Nientied & Shutina, 2020). Western Balkans have long been neglected by countries that are close geographically to them and received a lot of attention from Russia, China, Turkey and other long-distance nations (Jaćimović et al., 2023; Holzner & Schwarzhappel, 2018).

Many Balkan region countries have invested in the domestic market instead of the international market (Cvetkoska & Barisic, 2017; Nientied & Shutina, 2020). For the opening of the international market, foreign direct investments had been their vehicle. Foreign direct investments are the key ingredient for advancement in the region (Jaćimović et al., 2023). European Union would like to integrate the Balkans (Levitin & Sanfey, 2018; Cotella & Berisha, 2019) as in their best interest the area is a major partner (Cotella & Berisha, 2019). Initiatives like the 'Berlin Process' and loans from international financial institutes have been contrived to enhance and support the economies in their transition as EU members (Holzner & Schwarzhappel, 2018). Infrastructure, human capital and cooperation are the main thematic areas of involvement for the initiatives (Holzner & Schwarzhappel, 2018). European Union tried and failed to help the regional advancement through investments, but China has emerged as a valuable assistant in the Balkan region investment opportunity (Jaćimović et al., 2023; Holzner & Schwarzhappel, 2018) as a mandatory need for China's economic, diplomatic, energy and tourism advancement (Cotella & Berisha, 2019).

From 2012 onwards China has a keen interest in central and eastern European countries including the Balkan ones (Jaćimović et al., 2023). That action was a booster to the tourism in the region and to the promotion of the Chinese culture and investments in the area (Jaćimović et al., 2023). Not only by lending money but also by acquiring companies, China gains influence in the region (Cotella & Berisha, 2019). Most of the trade volume in the area has a trade partner the European Union but the share of strategic partnership in the area is being shared between Serbia which is a strategic partner to China and Serbia's strategic position in the area that has enhanced the valuable collaboration (Jaćimović et al., 2023). Many companies in the area have long-term contracts acquiring national tourism-related infrastructure and organizations and businesses in the area, among other sector businesses as energy and infrastructure-related operations (Jaćimović et al., 2023). For example, Jaćimović et al. (2023) and Cotella & Berisha (2019) indicate that 3 big investments, the Ban-Boljare highway, the Mihajo Pupin bridge and the Stanari thermal power plant in three different countries were investments from China. Most of the funds that got spent in the area from China, return to China because contractors and workers originate from China leaving less value added to each country (Cotella & Berisha, 2019). Russia is the



second largest investor to Serbia and Montenegro and then the list goes on with countries from the Gulf and the Middle East region (Jaćimović et al., 2023). The diversity and political instability in the region are the main attractions of tourism (Cvetkoska & Barisic, 2017) and it seems the foreign investments too.

### **1.3 Governmental investments in tourism**

The relationship of growth in tourism through investments is a contemporary issue that never seems to have sufficient literature (Nawaz & Hassan, 2016). For a destination to achieve the highest amount of visitors concerning its carrying environmental capacity, investments both public and private must be made. In other words, tourism growth comes only from the combination of public and private investment mix because 'public and private sectors are complimentary' especially in infrastructure-related investments (Nawaz & Hassan, 2016; Selimi et al., 2017).

Governmental investments are needed in areas without a strong private sector or with a private sector that contributes only to its economy and revenue streams and is not fond of contributing to society (Nguyen et al, 2020). Governments first invest in policy and then in services and infrastructure (Nawaz & Hassan, 2016). A government can use active involvement (managerial or developmental) with specific action to boost tourism advancement or a passive involvement (mandatory or supportive) with an action that will contribute to the tourism industry, but it is not meant for the tourism industry or is not applied towards the tourism industry (Nawaz & Hassan, 2016). Developing countries rely heavily on the public sector in each aspect of their economy (Nguyen et al, 2020) and they need the public sector to set action or kick-off an investment plan to provide stability and motivation for the private sector as businesses hesitate to work on new investments (Nawaz & Hassan, 2016, Nguyen et al., 2020). Thus, confidence is gained through public sector initiatives. Developing nations rely on locally made goods and services as a booster in the economy contrary to the importing alternatives and the training and advancement of their workforce (Jenkins & Henry, 1982).

As sustainability is not the main topic in tourism, investments should be made towards environmental protection (Nguyen et al., 2020). Overuse of the destination (known by the term environmental de-granulation) by tourists can damage the destination (Jenkins & Henry, 1982, Nguyen et al, 2020).

To achieve a good level of training and knowledge manual, highly skilled personnel are being imported with excessive payment to train the local personnel, acknowledging that this action will produce inequality (Jenkins & Henry, 1982).

In this paper we will examine national accounts like the Gross Domestic Product (G.D.P.), Gross fixed capital formation (G.F.C.F.), Gross Capital Formation (G.C.F.), and tourism revenue. Most of the governmental investments are included in some of these indexes, while the rest of the indexes denote the development that has been achieved and the well-being of each country. Secondary data are being analysed, and a comparative analysis is carried out. The methodology and data of the research follow. Conclusions and limitations come to integrate the research.

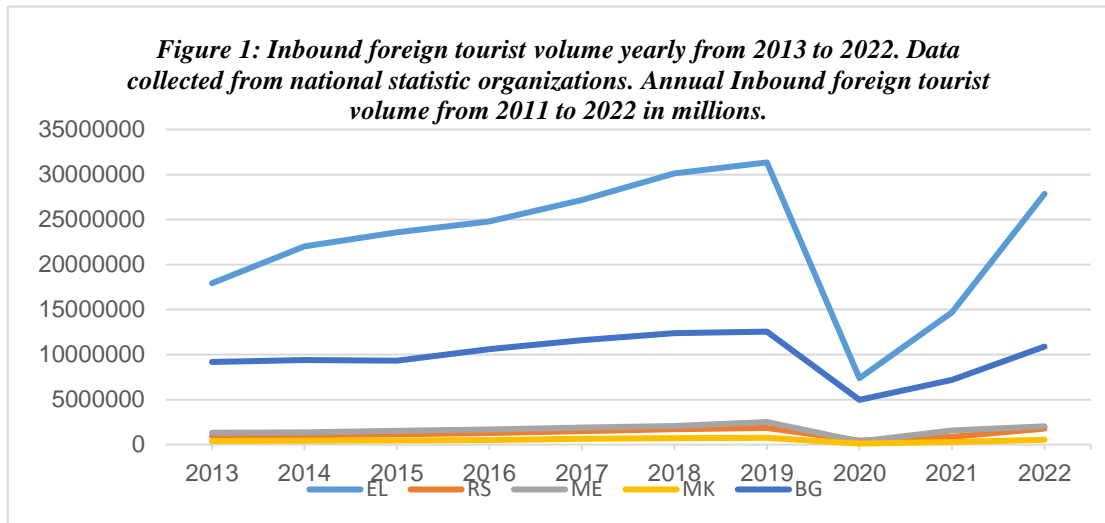
### **2. Methodology & Data**

Our contribution to the research about the Balkan locale comprises the collection and comparison of the corresponding statistics and comparable data from each country's statistical office that include inbound tourism, transportation and infrastructure, and national accounts about macroeconomic aggregates due to their implication on tourism development. For the arrangement and investigation of the figures that will be displayed, we indicate each nation with the 2 letter codes as the Eurostat (2023A; 2023B) applies (EL for Greece, MK for Republic of North Macedonia, ME for Montenegro, BG for Bulgaria, and RS for Serbia).

A foreign tourist is considered to be anyone, forever inhabitant exterior of each locale, who is temporarily present by visiting or passing through in the region of study and who spends at least one night in some accommodation establishment. Greece and Bulgaria have the greatest volume of visitors within the Balkan locale. All the aforementioned countries during the coronavirus and COVID-19 had seen a decline in tourist activity. Greece and Bulgaria, according to the volume of visitors, had the most noteworthy decrease amid COVID-19 and the most prominent increment after. The rest of the countries

V. International Applied Statistics Congress (UYIK - 2024)  
 İstanbul / Türkiye, May 21-23, 2024

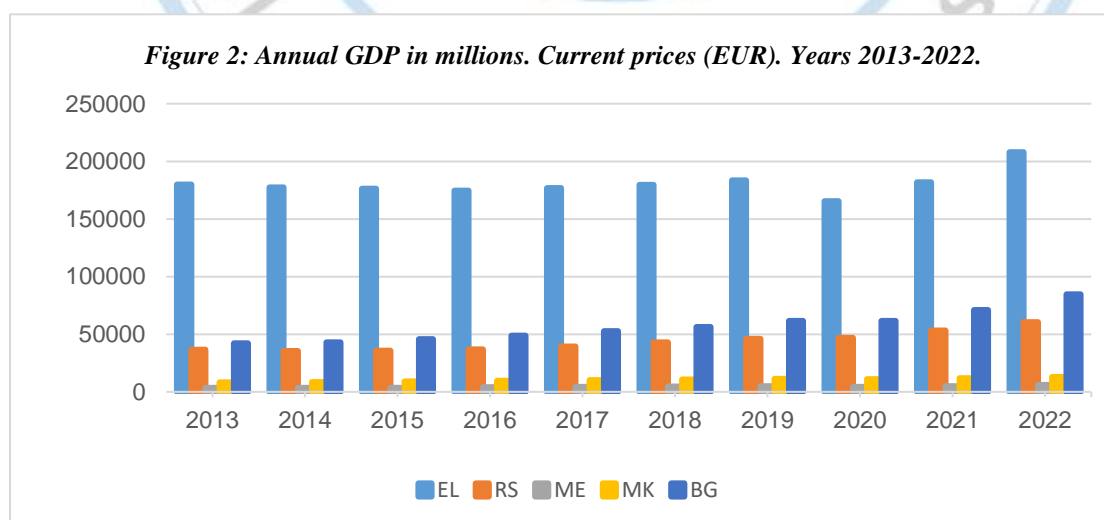
under investigation had smaller amounts of visitors that during the COVID-19 diminished, and after the pandemic expanded accordingly.



Source: Data collected from each county's statistics aggregations. (INSETE (2023); National Statistical Institute-Republic of Bulgaria (2013); State Statistical Office of the Republic of Macedonia (2016); Statistical Office of the Republic of Serbia. (2023); State Statistical Office of the Republic of Macedonia (2023); Statistical Office of Montenegro - MONSTAT (2023))

Fundamental macroeconomic principles dictate, that public investments can be followed too in the gross domestic product (G.D.P.) and the Gross fixed capital formation (G.F.C.F.).

Through the collection of the comparing data about the 2 indexes from the statistical offices of the aforementioned countries, we have made the equivalent figures. Fig. 2 shows the thriving and well-being of the economies through the GDP for the years 2013-2022. As we can see the production for the Greek economy remained steady for most of the years with a little diminish amid the coronavirus pandemic and an increase for the period after the COVID. Bulgaria incorporates a steady rate of increment for the GDP even within the pandemic 2-year lockdowns. Serbia, the Republic of North Macedonia, and Montenegro had extremely slight increases without any serious outburst of production.

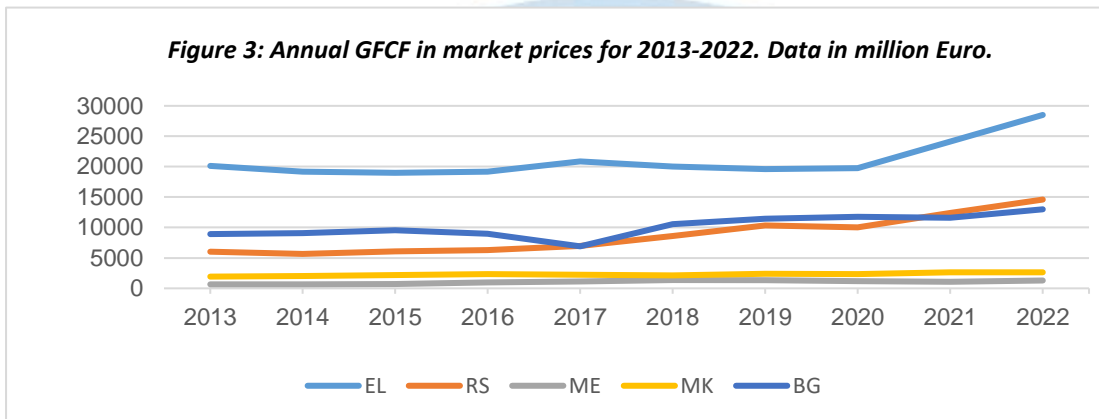


Source: Eurostat (2023A)

Gross fixed capital formation (G.F.C.F.) according to Lequiller & Blades (2014) and International Monetary Fund (2015) in the general government national accounts signifies (and contains) the

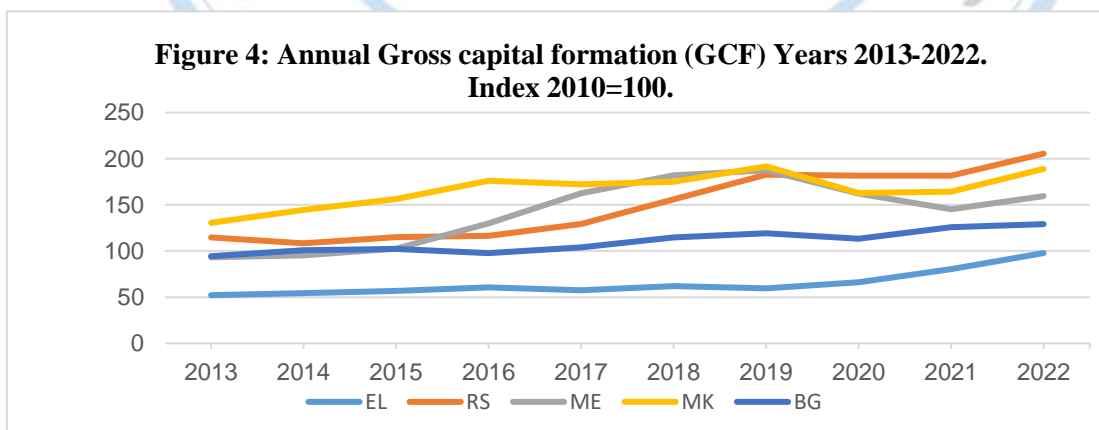
**V. International Applied Statistics Congress (UYIK - 2024)**  
**İstanbul / Türkiye, May 21-23, 2024**

investments for an economy such as infrastructure or buildings including the government for tourism ventures and tourism employments in a indicated sum of time. Holzner & Schwarzhappel (2018) utilise moreover the G.C.F.C. but as a rate of G.D.P. and in total construction investment. In Fig. 3 we can visualise and compare the data for the G.F.C.F. The secondary data originate from the Eurostat database. Since the result of each investment is the value that is going to be added to an economy (by investment in fixed assets in our case) we can understand that the economies under study are performing well. The data contribution for the last 10 years (2013-2022) indicates the amount of money that has been invested. A rise can be seen. The aforementioned countries got the attention of tourist streams. Figure 1 indicates the number of foreign-only tourists that were welcomed by each country during the years 2013-2022. The data have been gathered from the national statistics office of each aforementioned country and allude to foreign tourists only.



Source: Eurostat (2023B)

In Fig.4, all of our nations, under study, could provide data for the spending on fixed assets and the accumulation of those assets. The G.C.F for the years 2013-2022 gives us valuable information about capital formation. As we will see indeed even though Greece in broad outline had a high production of products and their value (GDP) at the same time had the lowest spending to acquire capital assets. On the other hand, the rest of the countries, till 2019, had a high rate of accumulation of fixed assets after the pandemic in 2020-2021. During the pandemic year, the rate had dropped as a natural cause of the downfall in production.



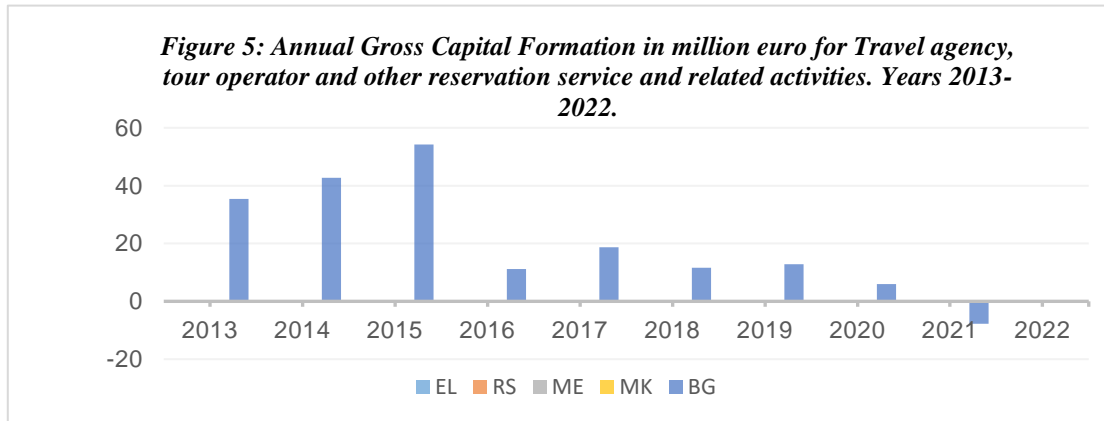
Source: Eurostat (2023A)

For the tourism industry, in 4 of the countries under investigation there was no extended information about what rate or sum in million Euro the G.C.F. has (fig. 5). In this way, it is difficult to estimate the value and contribution to tourism industry directly and/or indirectly from the statistical offices. Bulgaria is the only country where data were available and accessible and that had a high sum of investing in



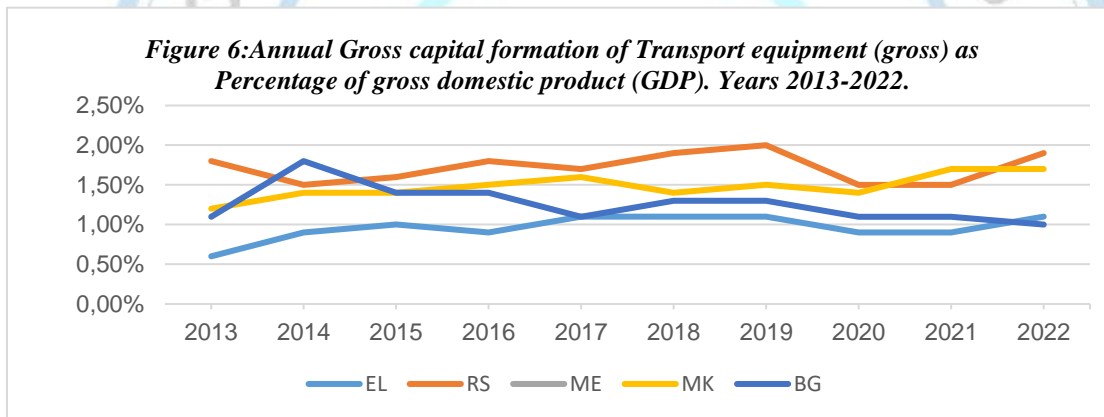
V. International Applied Statistics Congress (UYIK - 2024)  
 İstanbul / Türkiye, May 21-23, 2024

millions of Euros for the accumulation of fixed assets, contributing to the tourism industry each year, for years 2013-2015. After that period the contribution diminishes significantly and for the year 2021, there was a negative amount which could mean that some assets have been sold or disposed of.



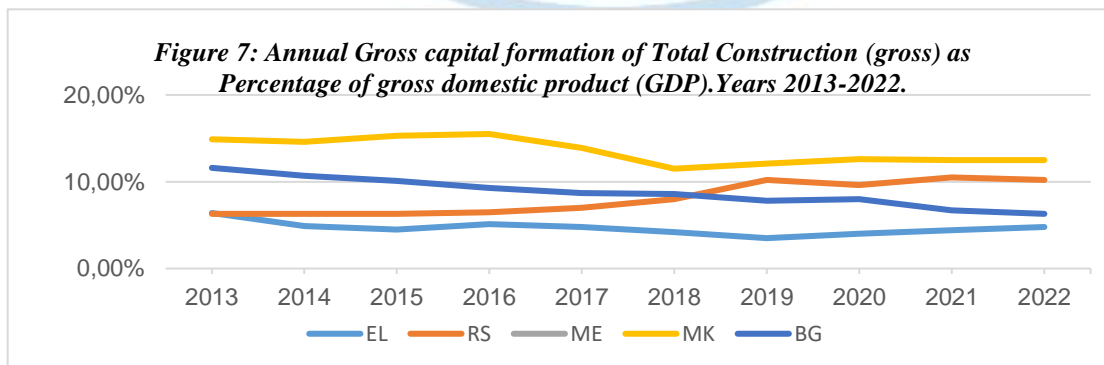
Source: Eurostat (2023B)

In the years 2013-2022 for all countries except Montenegro, there have been variances of increase and decrease within the capital formation for transport equipment. These fluctuations are not extreme and indicate a stable rate of acquisitions or disposal for the investigated period. No data were available for Montenegro.



Source: Eurostat (2023B)

The G.C.F. in total construction, within the corresponding period under investigation for our analysis for Bulgaria and Greece has decreased and in the last 2 years we can see an increase in the assets accumulated while North Macedonia and Serbia are steady for the first half years of the time frame studied and then they have an increase and stabilization on the accumulation. No data were available for Montenegro.



Source: Eurostat (2023B)

### 3. Limitations

Before coming to our conclusions, it is necessary to present the limitations of our research. Detailed statistics for many subsections of the Gross Capital Formation and the Gross fixed capital formation were not available, in any case, for the country under research. Data for 2021 for all the countries are revised and/or provisional in many cases. Concerning the year 2022, the data are entirely provisional or missing in many cases. Till the moment that the research had been conducted and published, the data might have changed significantly. Only 5 countries belonging to the Balkan region have been examined. Most of the countries under examination received interest in investments from the European Union and China.

### 4. Conclusions

The irrefutable truth that tourism has numerous benefits for a region has been appraised by many researchers (Nguyen et al, 2020; Cvetkoska & Barisic, 2017; Selimi et al., 2017). Direct or indirect investments for tourism ventures provide investments for the whole economy of a country and not only for a sub-sector and guarantee a new stream of revenue (Cvetkoska & Barisic, 2017; Nientied & Shutina, 2020). The Balkan region rose as an attractive tourism destination due to the combination of the history, that took place within the region (eg. wars) and the modern lifestyle. It is a contemporary destination for tourists who want to discover common aspects of life in an area and a differentiated portfolio of separate attractions. The region drew the attention of many investors, countries and institutions. With foreign financing and investments great infrastructure and superstructure projects came to advance and develop the area and the country that accomplished them. The governmental investments are setting the bar and opening the road for the private ones. It is a tremendous fact that without public or governmental investments (tangible or intangible ones) most of the private sector would not dare to follow up (Nawaz & Hassan, 2016, Nguyen et al., 2020). For emerging countries, public investments in combination with foreign expertise and locally made products can help the development of the area (Jenkins & Henry, 1982). Governmental investments can be found in the Gross fixed capital formation (G.F.C.F.) account (Lequiller & Blades (2014); International Monetary Fund (2015)), which counts in a specific time period the investments that occurred in an economy. Other accounts such as the G.D.P. and G.C.F. and statistics about tourism like the inbound tourists can help us infer assumptions indirectly about the economic development sector that we examine. In our paper, we examine the aforementioned accounts by comparison. No other research was found to study the countries under investigation. The secondary data that we examine indicate that the economic well-being through the GDP kept a rising rate till COVID-19 which paused the production but did not slow the economy enough as the decrease was small or non-existent at all as in Bulgaria which had a rise in GDP. Tourist arrivals had a stable rate of rise till the pandemic which dropped significantly and after the pandemic they had a great rise. The Gross Fixed Capital Formation remained stable for Montenegro and North Macedonia for the estimated periods but for the rest of the countries under investigation it had a rise from period to period. When the inbound tourists during the COVID-19 decreased the GDP in each aforementioned country did not get influenced tremendously. During the COVID-19 pandemic when all the economic activity had slowed down all these accounts followed the same direction. G.F.C. accounts for transport and construction seem to have small increases and decreases but not extreme ones. General G.F.C.'s account seems to always tend to rise. This probably comes from the need of each country for capital in every aspect of production or investment. Some of those increases are during times when the tourist arrivals have a peak. Finally, without data for the Gross Capital Formation for the hospitality, travel and tourism industry, we cannot make safe or at all assumptions about the investments that have been made or the capital that has been accumulated for future investments.

### References

- Cotellaa, G., & Berishab, E. (2019). From Space in Transition to Space of Transit-Risks and Opportunities of European and Chinese Investments in the Western Balkan Region. *Territorial Governance*, 1, 16-26.

**V. International Applied Statistics Congress (UYIK - 2024)**  
**İstanbul / Türkiye, May 21-23, 2024**

---

- Cvetkoska, V., & Barisic, P. (2017). The efficiency of the tourism industry in the Balkans. *Proceedings of the Faculty of Economics in East Sarajevo-Journal of Economics and Business*. DOI: 10.7251/ZREFIS1714031C
- Eurostat, the statistical office of the European Union. (2023A). Annual national accounts (nama10), GDP and main components (output, expenditure and income). Retrieved October 22, 2023, from Statistics. Eurostat (europa.eu)
- Eurostat the statistical office of the European Union. (2023B), Gross fixed capital formation by AN\_F6 asset type, Retrieved October 22, 2023, from [https://ec.europa.eu/eurostat/databrowser/view/nama\\_10\\_an6\\_\\_custom\\_7954973/default/table?lang=en](https://ec.europa.eu/eurostat/databrowser/view/nama_10_an6__custom_7954973/default/table?lang=en)
- Holzner, M., & Schwarzhappel, M. (2018). Infrastructure investment in the Western Balkans: a first analysis (No. 432), wiiw Research Report.
- INSETE. (2023). Key figures of Greek Tourism. Retrieved October 22, 2023, from <https://insete.gr/districts/?lang=en>
- International Monetary Fund. (2015). Making Public Investment More Efficient, IMF Archives Staff report
- Jaćimović, D. , Deichmann, J. I. , & Tianping, K. (2023). The Western Balkans and Geopolitics: Leveraging the European Union and China. *Journal of Balkan and Near Eastern Studies*, pp. 1-18.
- Jenkins, C. L. , & Henry, B. M. (1982). Government involvement in tourism in developing countries. *Annals of Tourism Research*, Vol 9(4), pp. 499–521, doi: 10.1016/0160-7383(82)90070-6
- Lequiller, F. and D. Blades (2014), *Understanding National Accounts: Second Edition*, OECD Publishing, Paris, <https://doi.org/10.1787/9789264214637-en>.
- Levitin, O., & Sanfey, P. (2018). Regional cooperation in the Western Balkans. *European Bank for Reconstruction and Development*, London.
- National Statistical Institute-Republic of Bulgaria. (2013). Trips of Bulgarian residents abroad and arrivals of visitors from abroad to Bulgaria. Retrieved October 22, 2023 from [https://infostat.nsi.bg/infostat/pages/module.jsf?x\\_2=236](https://infostat.nsi.bg/infostat/pages/module.jsf?x_2=236)
- Nawaz, M. A. , Hassan, S. (2016). Investment and Tourism: Insights from the Literature. *International Journal of Economic Perspectives*, Vol 10(4), pp. 581–590.
- Nguyen, C. P. , Binh, P. T. , & Su, T. D. (2020). Capital Investment in tourism: A global investigation. *Tourism Planning & Development*, pp. 1–27. <https://doi.org/10.1080/21568316.2020.1857825>
- Nientied, P., & Shutina, D. (2020). Tourism in transition, the post Covid-19 aftermath in the Western Balkans. *Annual Review of Territorial Governance in the Western Balkans*, 2, 46-60, <https://doi.org/10.32034/CP-TGWBAR-I02-04>.
- Selimi, N., Sadiku, M., & Sadiku, L. (2017). The impact of tourism on economic growth in the Western Balkan countries: An empirical analysis. *International Journal of Business and Economic Sciences Applied*.
- State Statistical Office of the Republic of Macedonia. (2016). Survey on foreign visitors at border crossings, 2016. Republic of North Macedonia. Retrieved October 22, 2023, from <https://www.stat.gov.mk/Publikacii/8.4.17.01.pdf>
- State Statistical Office of the Republic of Macedonia. (2023). MakStat database. Retrieved October 22, 2023, from [http://makstat.stat.gov.mk/PXWeb/pxweb/en/MakStat/MakStat\\_\\_TirizamUgostitel\\_\\_Turizam\\_\\_TuristiNokevanja/375\\_Turizam\\_Reg\\_Turisti\\_ml.px/?rxid=46ee0f64-2992-4b45-a2d9-cb4e5f7ec5ef](http://makstat.stat.gov.mk/PXWeb/pxweb/en/MakStat/MakStat__TirizamUgostitel__Turizam__TuristiNokevanja/375_Turizam_Reg_Turisti_ml.px/?rxid=46ee0f64-2992-4b45-a2d9-cb4e5f7ec5ef)
- Statistical Office of Montenegro - MONSTAT, (2023). Tourism - Releases. . Monstat. Retrieved October 22, 2023, from <https://www.monstat.org/eng/page.php?id=180&pageid=44>
- Statistical Office of the Republic of Serbia. (2023). Tourists arrivals and overnight stays by regions and areas - annual data. Retrieved October 22, 2023, from <https://data.stat.gov.rs/Home/Result/220201?languageCode=en-US&displayMode=table&guid=7ff2dbae-3d16-4213-9227-d787476868aa>
- Tomka, D. (2014). On the Balkans–history, nature, tourism and dilemmas faced by researchers. *American journal of tourism management*, 3(1B), 0-0.



## İklim Değişikliğinin Ekonomik Büyüme, İşsizlik ve Nüfus Yoğunluğu Arasındaki İlişkinin İncelenmesi: Türkiye Örneği

**Merve OKTAY<sup>1\*</sup>, Hakan EYGÜ<sup>2</sup>**

<sup>1</sup>Atatürk University, Faculty of Economics and Administrative Sciences, Department of Econometrics,  
Orcid: 0000-0001-8595-1099, Erzurum, Türkiye

<sup>2</sup>Atatürk University, Faculty of Economics and Administrative Sciences, Department of Econometrics,  
Orcid: 0000-0002-4104-2368, Erzurum, Türkiye

\*Sorumlu yazar e-mail: mrvoktay@gmail.com

### Özet

Çevre ile ekonomik faktörler arasındaki ilişkilerin anlaşılması, son yıllarda önemli bir araştırma alanı haline gelmiştir. Çevre ile ekonomik faktörler arasındaki ilişkilerin anlaşılması ve bu ilişkilerin yönetilmesi, küresel düzeyde giderek artan bir öneme sahiptir. İklim değişikliği, doğal kaynakların tükenmesi, çevre kirliliği ve biyoçeşitlilik kaybı gibi çevresel sorunlar, dünya genelinde ciddi endişelere yol açmaktadır. Bu sorunlar, ekonomik sistemlerin ve toplumların dayandığı doğal kaynakların sürdürülebilirliğini tehdit etmektedir. CO<sub>2</sub> emisyonları, Gayri Safi Yurtiçi Hasıla (GDP), işsizlik ve nüfus yoğunluğu gibi değişkenler arasındaki ilişkilerin incelenmesi, sürdürülebilir kalkınma hedeflerini belirleme ve çevresel politikaların etkinliğini değerlendirme açısından önemlidir. Bu çalışmada CO<sub>2</sub> emisyonlarının ekonomik büyüme, işsizlik ve nüfus yoğunluğu ile nasıl ilişkili olduğunu belirlemek amaçlanmıştır. Bu bağlamda, serilerin durağan olup olmadığını belirlemek için öncelikle birim kök testleri yapılmıştır. Daha sonra ARDL (Auto Regressive Distributed Lag) sınır testi, değişkenler arasındaki uzun vadeli ilişkileri ve kısa vadeli dinamikleri incelemek için yaygın olarak kullanılan bir yöntem olduğundan sınır testi yapılmıştır. CO<sub>2</sub> emisyonlarının ekonomik büyüme ile negatif bir ilişkiye sahip olduğunu belirlenmiştir. Ayrıca işsizlik ve nüfus yoğunluğu gibi faktörlerin de kısa dönemde CO<sub>2</sub> emisyonları üzerinde etkisi olduğu ancak uzun dönemde bir etkisi olmadığı belirlenmiştir. Bu bağlamda kısa dönemde yüksek işsizlik oranları, enerji talebinde azalma ve dolayısıyla CO<sub>2</sub> emisyonlarında düşüşle ilişkilendirilebilir. CO<sub>2</sub> emisyonları ile ekonomik büyüme, işsizlik ve nüfus yoğunluğu arasındaki karmaşık ilişkilerin anlaşılması, sürdürülebilir kalkınma hedeflerine ulaşma çabalarında önemli bir adım olabilir. Bu tür çalışmalar, çevresel politikaların etkinliğini artırmak ve ekonomik büyüme ile çevresel sürdürülebilirlik arasında bir denge kurmayı amaçlayan politika kararlarını desteklemek için önemlidir.

**Anahtar Kelimeler:** Çevre kirliliği, Ekonomik büyüme, İşsizlik, Enerji

### GİRİŞ

Günümüzde çevre ile ekonomik faktörler arasındaki ilişkilerin anlaşılması, son yıllarda giderek artan bir öneme sahiptir. Bu ilişkilerin doğru bir şekilde anlaşılması ve etkin bir şekilde yönetilmesi, küresel düzeyde çevresel sürdürülebilirliği sağlama çabalarının merkezinde yer almaktadır. İklim değişikliği, doğal kaynakların tükenmesi, çevre kirliliği ve biyoçeşitlilik kaybı gibi çevresel sorunlar, dünya genelinde ciddi endişelere yol açmaktadır ve bu sorunlar ekonomik sistemlerin ve toplumların dayandığı doğal kaynakların sürdürülebilirliğini tehdit etmektedir. Bu bağlamda, CO<sub>2</sub> emisyonları, Gayri Safi Yurtiçi Hasıla (GDP), işsizlik ve nüfus yoğunluğu gibi değişkenler arasındaki ilişkilerin incelenmesi büyük önem taşımaktadır. Bu ilişkilerin doğru anlaşılması, sürdürülebilir kalkınma hedeflerinin belirlenmesi ve çevresel politikaların etkinliğinin değerlendirilmesi açısından kritik bir adımdır. İklim değişikliği, belki de en önde gelen çevresel sorunlardan biri olarak öne çıkmaktadır. Fosil yakıtların yanması, sanayi faaliyetleri ve ormansızlaşma gibi insan faaliyetleri, sera gazlarının atmosferde birikmesine ve gezegenimizin ısınmasına neden olmaktadır. Bu da iklimin değişmesine, kutup buzullarının erimesine, deniz seviyelerinin yükselmesine ve aşırı hava olaylarının sıklığının artmasına

yol açmaktadır. Bu etkiler, tarım, su kaynakları, enerji üretimi ve diğer endüstriler üzerinde ciddi bir baskı oluşturarak ekonomik sistemleri etkilemektedir.

Doğal kaynakların tükenmesi de büyük bir endişe kaynağıdır. Su, toprak, ormanlar, mineraller ve biyolojik çeşitlilik gibi kaynaklar, ekonomik faaliyetler için temel oluşturur. Ancak, aşırı kullanım, plansız tüketim ve kirlilik gibi faktörler, bu kaynakların sınırlı stoklarını hızla tüketmektedir. Bu durum, gelecekte kaynakların daha da kıtlaşmasına ve ekonomik büyümeyi sınırlayıcı bir faktör haline gelmesine neden olabilir.

Bu çalışmada, CO<sub>2</sub> emisyonlarının ekonomik büyüme, işsizlik ve nüfus yoğunluğu ile olan ilişkisinin incelenmesi amaçlanmıştır. Öncelikle, birim kök testleri ile serilerin durağanlığı belirlenmiştir. Daha sonra ise ARDL (AutoRegressive Distributed Lag) sınır testi kullanılarak değişkenler arasındaki uzun vadeli ilişkiler ve kısa vadeli dinamikler incelenmiştir.

Çalışma sonuçlarına göre, CO<sub>2</sub> emisyonlarının ekonomik büyüme ile pozitif bir ilişkiye sahip olduğu belirlenmiştir. Yani, artan ekonomik aktivite genellikle daha yüksek CO<sub>2</sub> emisyonlarına yol açmaktadır. Ayrıca, işsizlik ve nüfus yoğunluğu gibi faktörlerin de CO<sub>2</sub> emisyonları üzerinde etkisi olduğu tespit edilmiştir. Özellikle, yüksek işsizlik oranlarının enerji talebinde azalmaya ve dolayısıyla CO<sub>2</sub> emisyonlarında düşüşe neden olduğu gözlemlenmiştir. Bu bağlamda, CO<sub>2</sub> emisyonları ile ekonomik büyüme, işsizlik ve nüfus yoğunluğu arasındaki karmaşık ilişkilerin anlaşılması, sürdürülebilir kalkınma hedeflerine ulaşma çabalarında önemli bir adım olarak değerlendirilmektedir. Bu tür çalışmalar, çevresel politikaların etkinliğini artırmak ve ekonomik büyüme ile çevresel sürdürülebilirlik arasında denge kurmayı amaçlayan politika kararlarını desteklemek için kritik öneme sahiptir.

## LİTERATÜR

Günümüzde çevre sorunları, özellikle iklim değişikliği, ekonomik büyüme, işsizlik ve nüfus yoğunluğu gibi önemli sosyo-ekonomik faktörlerle ilişkilendirilmektedir. Bu bağlamda, Türkiye gibi gelişmekte olan ülkelerin iklim değişikliği ile ekonomik büyüme, işsizlik ve nüfus yoğunluğu arasındaki ilişkileri anlamak ve yönetmek önemlidir. İklim değişikliği, hızlı gelişen kasırgalar ve tayfunlar gibi doğal afetlerle birlikte yavaş ilerleyen kuraklık ve kıtlık gibi süreçlerle tanımlanır (Memiş ve Aydın, 2023). Bu durumda, iklim değişikliğinin etkisiyle, ekosistemlerin özellikleri zayıflar, gıda ve su kaynakları işlevsiz hale gelir, insanlar çeşitli sağlık sorunlarıyla karşılaşır ve zorunlu göçler yaşanabilir, hatta erken ölümler gerçekleşebilir (Amini vd., 2019; Lelieveld vd., 2020). Bu bağlamda iklim değişikliklerinde en çok araştırılan ise ölüm oranlarıdır. Bir ülkede ölüm sayısının fazla olması ekonomiyi de etkilemektedir (Bell vd., 2013; Schwartz vd. 2018; Vodonos vd. 2018). Özellikle ekonomik büyümeyi temsil eden gelir düzeyi (Lomborg, 2020) sıcaklık değerleri arasındaki artış azalışın etkisinin de olduğu belirtilmektedir (Dell vd., 2012). Bu bağlamda Ng vd. (2022) OECD ülkeleri üzerine yaptıkları çalışmada işsizlik ile çevresel bozulma arasında bir denge olmasına rağmen, özellikle temiz enerji sektöründe yeni teknolojilerin geliştirilmesi, sürdürülebilir büyümeye ve daha iyi çevre kalitesine katkıda bulunan temel bir faktör olabileceğini belirtmişlerdir. Ben Mbarek vd. (2018) enerji ile ekonomik büyüme arasındaki ilişkiyi doğrusal olmayan nedensellik testi kullanarak incelemişlerdir. Çalışma sonucunda enerji teşvik programlarının ekonomik büyüme üzerinde geniş bir etkiye sahip olduğunu belirlemişlerdir. Benzer bir çalışmada Bangladeş, Hindistan, Pakistan ve Sri Lanka'da yenilenebilir enerji gelişimi, işsizlik ve GSYİH büyümesi arasındaki etkileşimi araştırılmıştır. Araştırma sonucunda seçilen Güney Asya ülkelerinde yenilenebilir enerji tüketimi, işsizlik ve GSYİH büyümesi arasında önemli bir eş-bütünleşme olduğunu ortaya koymaktadır. Uzun vadeli tahmin, yenilenebilir enerji tüketiminin Bangladeş'teki ekonomik ilerlemeyi olumsuz etkilediğini ve işsizlikle kayda değer bir korelasyon olmadığını gösteriyor (Rahman vd., 2023; Abbas vd., 2018). Ayrıca çevre kirliliğine neden olan faktörler için vergilerin artırılması, ekonomik büyümenin azalması ile birlikte işsizliği de etkilemektedir (Bovenberg ve Van der Ploeg, 1998).

## SONUÇLAR VE DEĞERLENDİRME

### Ampirik Bulgular

Birim kök testlerine geçilmeden önce Çizelge 1’de değişkenlerin tanımlayıcı istatistikleri verilmiştir.

**Tablo 1. Tanımlayıcı İstatistikler**

	LCO <sub>2</sub>	LGDP	LGDP2	LUNP	LPOP
Ortalama	1.084	8.794	77.448	2.201	4.380
Median	1.102	8.759	76.734	2.166	4.393
Max	1.588	9.393	88.232	2.529	4.672
Min	0.499	8.279	65.247	1.871	4.045
Std. Sapma	0.302	0.325	5.748	0.176	0.180
Çarpıklık	-0.215	0.247	-0.299	-0.009	-0.167
Basıklık	2.116	2.017	2.039	2.041	1.936
Jarque-Bera	1.569*	1.969*	2.084*	1.494*	2.019*

Note: \*, \*\*, and \*\*\* define significance at the 1%, 5%, and 10% levels, respectively.

Birim kök testleri bir ön test olup devamında yapılacak analizler için bir ön araştırmadır. Yani devamında yapılacak analiz yöntemleri (eşbütünlüşme mi, nedensellik mi yapılacak vs.) için bir belirleyicilik sağlamaktadır. ADF ve PP birim kök testleri kullanılarak serinin durağan olup olmadığı belirlenmiştir.

Çizelge 2’de ADF, PP ve KPSS birim kök test sonuçları verilmiştir. ADF ve PP birim kök testleriyle serinin durağan olup olmadığını göstermek için hipotezler,

H<sub>0</sub>: Seri durağan değildir (Birim kök içermez)

H<sub>1</sub>: Seri durağandır (Birim kök içerir) şeklinde kurulmaktadır.

ADF ve PP testleri sabit model ile sınanmıştır. ADF ve PP testi için sabit modelde durağan olduğu görülmektedir.

**Tablo 2. Birim Kök Analizi Sonuçları**

Model	ADF	PP
Değişkenler	Test-ist.	Test-ist.
Level		
LCO <sub>2</sub>	-1.009 (0.740)	-1.117 (0.699)
LGDP	0.218 (0.970)	0.500 (0.984)
LGDP2	0.389 (0.979)	0.895 (0.944)
LUNP	-2.531 (0.116)	-2.538 (0.115)
LPOP	0.526 (0.984)	-3.221** (0.026)
Birinci fark		
ΔLCO <sub>2</sub>	-4.484* (0.000)	-4.601* (0.000)
ΔGDP	-4.527* (0.000)	-4.706* (0.000)
ΔGDP2	-4.474* (0.000)	-4.651* (0.000)
ΔUNP	-5.753* (0.000)	-6.358* (0.000)
ΔPOP	-2.790* (0.006)	-1.640*** (0.094)

ADF testinde maksimum gecikme sayısı 4 olarak alınmış ve optimum gecikme sayısı Schwarz Bilgi Kriterine göre belirlenmiştir. \*, \*\* ve \*\*\* sırasıyla %1, %5 ve %10 düzeylerinde anlamlılığı tanımlar.

ADF testi için H<sub>0</sub> hipotezi seri birim kök içerir şeklinde kurulmuştur ve sabitli model üzerinden ADF denkleminin tahmin edildiği görülmektedir. Dolayısıyla serinin birim kök içermediği yani serinin durağan olduğu görülmektedir.



Daha sonra tahmin edilen ARDL modelinin serisel korelasyon ya da değişen varyans olup olmadığına karar vermek için korelasyon testi yapılmıştır ve elde edilen sonuçlar Çizelge 3'te verilmiştir.

**Tablo 3. Serilerin Korelasyon Testi**

Breusch-Godfrey LM Testi			
F değeri	0.974	p-değ.	0.434
R <sup>2</sup> değeri	4.666	p-değ. Chi-Square(4)	0.323

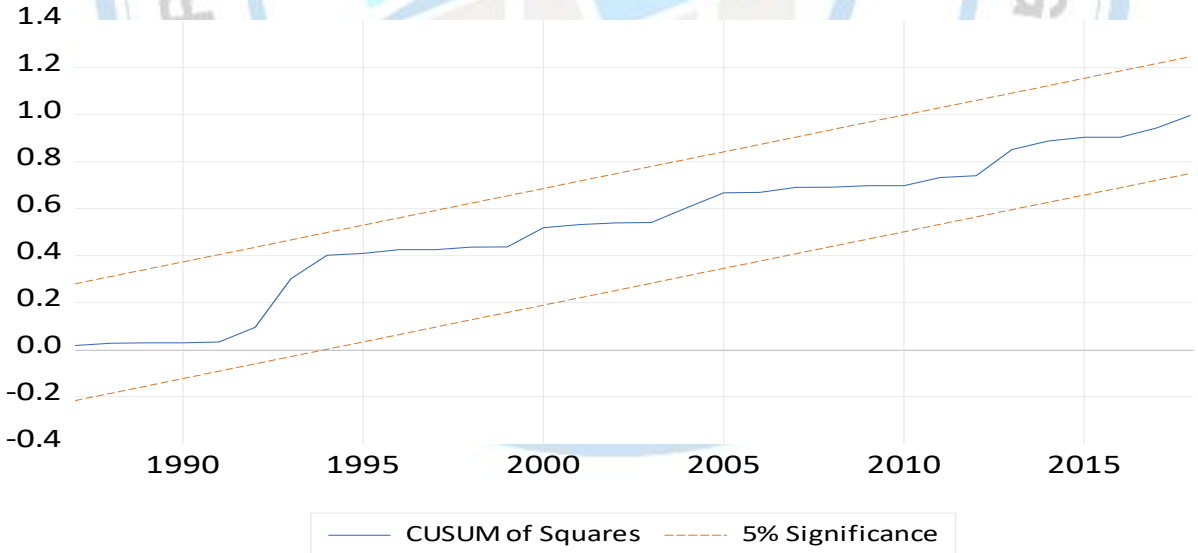
Tahmin edilen ARDL modelinde 4 gecikmeye kadar olan korelasyon testi için,  $F=0.974$  ve  $p=0.434$  olarak bulunmuştur.  $p>0.05$  olduğundan 4 gecikmeye kadar seriler arasında korelasyonun olmadığını gösteren  $H_0$  hipotezi reddedilmez. Böylece seriler arasında korelasyon sorunu olmadığı söylenebilir. Modelde değişen varyans olup olmadığı ve modelin normal dağılıma uyup uymadığını belirlemek için ise değişen varyans testi ve normallik testi yapılmış ve Çizelge 4'te verilmiştir.

**Tablo 4. Değişen Varyans ve Normallik Testi**

Heteroskedasticity Test: Breush-Pagan-Godfrey			
F değeri	2.408	p-değ. F(6,31)	0.052
R <sup>2</sup> değeri	12.082	p-değ. Chi-Square(6)	0.061
Jarque-Bera	2.321	p-değ.	0.313

Tahmin edilen ARDL modelinde değişen varyans testi için  $F=2.408$  ve  $p=0.052$  bulunmuştur.  $p>0.05$  olduğundan sabit varyansı gösteren  $H_0$  hipotezi reddedilemez. Böylece modelde değişen varyans sorunu olmadığı söylenebilir. Ayrıca normallik testi için  $p>0.05$  olduğundan kalıntıların normal dağıldığı söylenebilir.

Tahmin edilen değişkenlerin istikrarlı olup olmadığını belirlemek için CUSUM grafiklerine bakılmıştır.



**Görsel 1. ARDL Modeli için CUSUMSQ Grafiği**

Grafikte kesikli çizgiler %95 güven sınırlarını düz çizgi ise parametre değerini göstermekte olup parametrelerin istikrarlı olduğu belirlenmiştir. Daha önce belirlediğimiz ARDL(1,0,01,0) modelinden yararlanılarak hesaplanan uzun dönem sonuçları Çizelge 5'te verilmiştir.

**Tablo 5. Uzun Dönem Tahmini**

Değişken	Katsayı	Standart hata	t ist.	p-deg.
LGDP	-0.611	0.205	-2.974	0.005
LGDP2	0.069	0.004	15.990	0.000
LUNP	-0.036	0.362	0.936	0.356
LPOP	0.339	0.362	0.936	0.356

\*, \*\* ve \*\*\* sırasıyla %1, %5 ve %10 düzeylerinde anlamlılığı tanımlar.

Çizelge 5 incelendiğinde değişkenler arasında uzun dönemde denge ilişkisi görülememektedir. Bu sonuçlara göre modeldeki işsizlik ve popülasyon yoğunluğu anlamlı bulunamamıştır. Ancak ekonomik büyüme ile CO<sub>2</sub> emisyonu arasında anlamlı bir ilişki bulunmuştur. GDP değişkeninin katsayısının negatif ve anlamlı, GDP2 değişkeninin katsayısının pozitif ve anlamlı olması Türkiye’de analiz edilen dönem içerisinde çevresel Kuznets eğrisi hipotezinin geçerli olmadığı anlamına gelmektedir. Gelirin belirli bir noktaya gelse bile salımların artacağı söylenebilir.

### GENEL DEĞERLENDİRME VE SONUÇLAR

Bu çalışmada, 1980-2019 döneminde Türkiye ekonomisi özelinde bağımlı değişken karbon salımı (CO<sub>2</sub>) olarak alınıp diğer değişkenlerle beraber uzun dönem bir ilişkinin varlığı ARDL sınır testi ile incelenmiştir. Çalışmada kullanılan değişkenlerin durağan olup olmadıkları ADF ve Phillips Perron testleri yardımıyla incelenmiş ve serilerin düzey değerlerinde durağan olmadıkları tespit edilmiştir. Ancak serilerin birinci farkları alındıklarında serilerin birim kök içermedikleri ve durağan oldukları belirlenmiştir. Değişkenler arasında eşbütünlük ilişkisinin olup olmadığı ARDL sınır testi ile test edilmiş ve değişkenler arasında eşbütünlük ilişkisinin olduğu belirlenmiştir.

Bu sonuçtan hareketle değişkenler arasında kısa dönemde tahmin yapmanın belirleyici olmamasından dolayı uzun dönem ilişkiye bakılmıştır. Uzun dönemde ekonomik büyümenin karbon salımı (CO<sub>2</sub>) ile arasında negatif anlamlı bir ilişki bulunmuştur. Bu bağlamda ekonomik büyüme, yenilenebilir enerji kaynaklarına yapılan yatırımları artırabilir. Yenilenebilir enerji kaynakları, fosil yakıtlara göre daha az karbon salımıyla enerji üretirler, bu da ekonomik büyüme ile karbon salımı arasındaki negatif ilişkiyi güçlendirir. Yapılan uzun dönem analizinde işsizlik ve popülasyon yoğunluğu değişkenlerinin ekonomik büyüme değişkeni arasında bir ilişki bulunamamıştır.

### KAYNAKÇA

- Abbas, S. Z., Kousar, A., Razzaq, S., Saeed, A., Alam, M., & Mahmood, A. (2018). Energy management in South Asia. *Energy Strategy Reviews*, 21(April), 25–34. doi: 10.1016/j.esr.2018.04.004. (Erişim tarihi: 23.03.2024)
- Amini, H., Nhung, N. T. T., Schindler, C., Yunesian, M., Hosseini, V., Shamsipour, M. and Künzli, N. (2019). Short-term associations between daily mortality and ambient particulate matter, nitrogen dioxide, and the air quality index in a Middle Eastern megacity. *Environmental Pollution*, 254, 113121. <https://doi.org/10.1016/j.envpol.2019.113121> (Erişim tarihi: 23.03.2024)
- Bell, M. L., Zanobetti, A., & Dominici, F. (2013). Evidence on vulnerability and susceptibility to health risks associated with short-term exposure to particulate matter: a systematic review and meta-analysis. *American Journal of Epidemiology*, 178(6), 865-876. <https://doi.org/10.1093/aje/kwt090> (Erişim tarihi: 23.03.2024)
- Ben Mbarek, M., Abdelkafi, I., & Feki, R. (2018). Nonlinear causality between renewable energy, economic growth, and unemployment: evidence from Tunisia. *Journal of the Knowledge Economy*, 9(2), 694-702. (Erişim tarihi: 23.03.2024)

**V. International Applied Statistics Congress (UYIK - 2024)**  
**İstanbul / Türkiye, May 21-23, 2024**

---

- Bovenberg, A. L., & Van der Ploeg, F. (1998). Consequences of environmental tax reform for unemployment and welfare. *Environmental and Resource Economics*, 12, 137-150. <https://doi.org/10.1023/A:1016040327622>
- Dell, M., Jones, B. F. & Olken, B. A. (2012). Temperature shocks and economic growth: Evidence from the last half century. *American Economic Journal: Macroeconomics*, 4(3), 66-95. (Erişim tarihi: 23.03.2024)
- Lomborg, B. (2020). Welfare in the 21st century: Increasing development, reducing inequality, the impact of climate change, and the cost of climate policies. *Technological Forecasting and Social Change*, 156, 119981. <https://doi.org/10.1016/j.techfore.2020.119981> (Erişim tarihi: 23.03.2024)
- Memiş, O. B. ve Aydın, R. (2023). İklim değişikliğinin ekonomik büyüme üzerine etkisi: Türkiye örneği. *Third Sector Social Economic Review*, 58(2), 1065-1080. 10.15659/3.sektor-sosyal-ekonomi.23.04.2098 (Erişim tarihi: 23.03.2024)
- Ng, C. F., Yii, K. J., Lau, L. S., & Go, Y. H. (2022). Unemployment rate, clean energy, and ecological footprint in OECD countries. *Environmental Science and Pollution Research*, 1-10. (Erişim tarihi: 23.03.2024)
- Rahman, M. R., Rahman, M. M., & Akter, R. (2023). Renewable energy development, unemployment and GDP growth: South Asian evidence. *Arab Gulf Journal of Scientific Research*. <https://doi.org/10.1108/AGJSR-04-2023-0152> (Erişim tarihi: 23.03.2024)
- Schwartz, J., Fong, K., & Zanobetti, A. (2018). A national multicity analysis of the causal effect of local pollution, NO<sub>2</sub>, and PM<sub>2.5</sub> on mortality. *Environmental Health Perspectives*, 126(8), 087004. <https://doi.org/10.1289/EHP2732> (Erişim tarihi: 23.03.2024)
- Vodonos, A., Awad, Y. A., & Schwartz, J. (2018). The concentration-response between long-term PM<sub>2.5</sub> exposure and mortality; A meta-regression approach. *Environmental Research*, 166, 677-689. <https://doi.org/10.1016/j.envres.2018.06.021> (Erişim tarihi: 23.03.2024)



Statistical Analysis Methods in Modeling of Ecological Sounded Chemical Process

**Chimnaz Shabanova<sup>1\*</sup>**

<sup>1</sup>M.Nagiyev Institute of Catalysis and Inorganic Chemistry MSE Azerbaijan, "Modeling and technology of chemical and ecological processes" department, AZ1143, Baku, Azerbaijan

Corresponding author e-mail: [shabanovacm@mail.ru](mailto:shabanovacm@mail.ru)

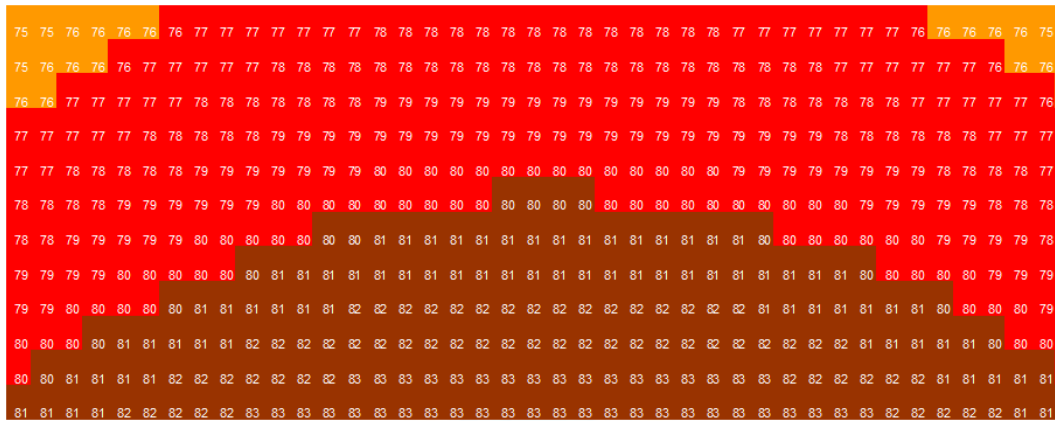
**Abstract**

*The paper presents the results of statistical modeling of the process of phenol destruction by hydrogen peroxide in the presence of a composite catalyst based on carbon fiber containing metal/metal oxide. Based on the constructed regression model of the process, the optimal region was calculated, providing a wide range of selection in the optimal parameters sets corresponding to the maximum result of the process.*

**Keywords:** Regression, Optimization, Visualisation, Response Surface

Paper used results of studies from [1], conducted on the decomposition of phenol -C<sub>6</sub>H<sub>5</sub>OH - in the presence of a composite catalyst based on carbon fiber containing metal/metal oxide (with iron/iron oxide) for heterogeneous liquid-phase oxidation of phenol with hydrogen peroxide -H<sub>2</sub>O<sub>2</sub>. Based on experimental data on the oxidation of phenol with hydrogen peroxide, obtained in [1], numerical model was developed using regression analysis. It was used a statistical model in the form of a second degree polynomial:  $f(\tau, \theta) = -0,49 + 0,2342 \cdot \tau + 8,9985 \cdot \theta + 0,00091 \cdot \tau \cdot \theta + 0,000304 \cdot \tau^2 - 0,6564 \cdot \theta^2$  (1)

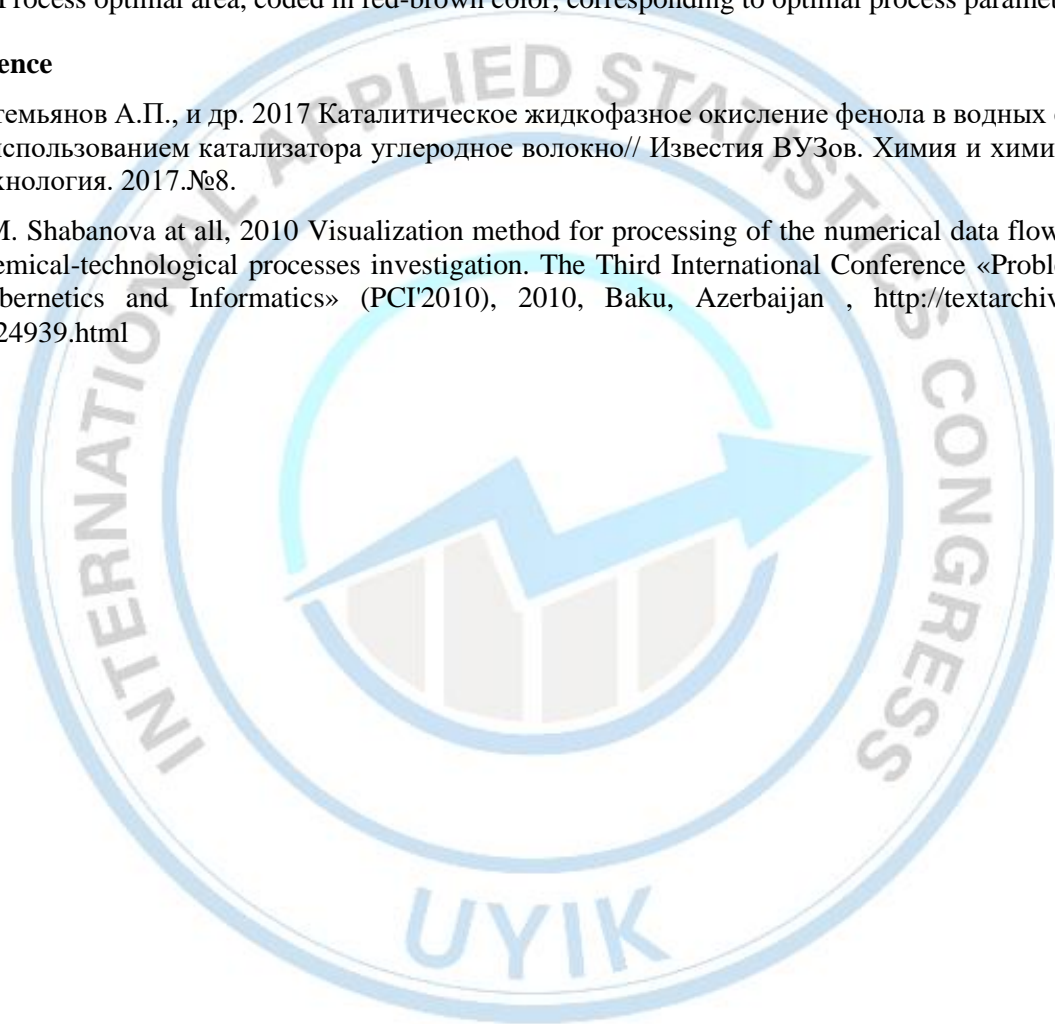
Using the replacement of variables, a linearized model was obtained from regression equation (1), the coefficients of which were estimated using the Least Squares Method (OLS). The statistical model establishes the functional dependence of the product yield ( $f(\tau, \theta)$ , %) on 2 process parameters: contact time of the product with the heterogeneous catalyst,  $\tau$  (min); molar ratio C<sub>6</sub>H<sub>5</sub>OH : H<sub>2</sub>O<sub>2</sub>,  $\theta$  (n). Regression analysis of equation (1) was carried out according to the established scheme. The calculated approximation error  $A = 4.619958\%$ , which is in the range of 5–7%, indicates a good fit of the model to the original data. The adequacy of the regression equation was checked using Fisher's test. Since  $R^2 = 98.86$ , the actual value of  $F = 69.541 > F_{kp}(5;4) = 6.2561$ , the coefficient of determination is statistically significant and the regression equation is statistically reliable (i.e., the coefficients of the model are jointly significant). To solve the problem of process optimization, a specially developed software module was used, based on the method of digital visualization of the optimal parameters of the model calculation process [2]. This method effectively combines programming capabilities in Excel and analytical methods for describing processes in the form of a regression model. The color coding used in the module, applied to different data ranges, allows to visualize, with specified conditions, clusters of areas of interest, optimal areas, optimal points. As a result of applying the visualization module to the conditional optimization method when imposing conditions on the objective function:  $f \in (77 - 80) \cup (80.1 - 100) \%$  for the process under consideration, visualized optimal areas were obtained. process parameters Data from the optimal region, colored in red-brown tones, are partially shown in Fig 1. Data from the optimal region of the response surface of phenol destruction values are in full agreement with the experimental data from [1].



**Fig.1** Process optimal area, coded in red-brown color, corresponding to optimal process parameters.

### Reference

1. Артемьянов А.П., и др. 2017 Каталитическое жидкофазное окисление фенола в водных средах с использованием катализатора углеродное волокно// Известия ВУЗов. Химия и химическая технология. 2017.№8.
2. С.М. Shabanova at all, 2010 Visualization method for processing of the numerical data flow at the chemical-technological processes investigation. The Third International Conference «Problems of Cybernetics and Informatics» (PCI'2010), 2010, Baku, Azerbaijan , <http://textarchive.ru/c-2424939.html>



**Balancing Strength, Sustainability and Conservation in Seismic-Prone Regions**

**Irakli Premti<sup>1,a\*</sup>, Dhurata Premti<sup>2,b</sup>, Ilirjan Malollari<sup>2</sup>**

<sup>1</sup>Department of Civil Engineering, Polytechnic University, Tirana, Albania

<sup>2</sup>Department of Industrial Chemistry, Faculty of Natural Sciences, University of Tirana, Albania

<sup>a\*</sup>[ipremti@gmail.com](mailto:ipremti@gmail.com), <sup>b</sup>[dhurata.koraj@fshn.edu.al](mailto:dhurata.koraj@fshn.edu.al), <sup>c</sup>[ilir.malo@gmail.com](mailto:ilir.malo@gmail.com)

**Abstract**

*This study investigates the suitability of locally produced C20 steel for sustainable seismic-resistant construction in Albania. We analyze the mechanical properties, chemical composition, and environmental impact of C20 steel compared to European standards (S235JR/S235J2 steel). The results demonstrate C20 steel's high yield and ultimate tensile strengths, exceeding European benchmarks, making it suitable for earthquake-prone regions. However, slightly lower elongation values compared to the standard highlight the need for careful design considerations. The environmental impact analysis explores the trade-offs between C20 steel's high initial carbon footprint and its durability, reducing the need for frequent replacements. The study emphasizes the importance of water resource conservation during construction. Utilizing alternative materials with lower embodied water content, alongside practices like rainwater harvesting, can be explored to minimize the environmental impact on this vital resource.*

**Keywords:** *mechanical properties, chemical composition, urban areas, construction steel.*

**Introduction**

Seismic activity and growing urban populations pose significant challenges for construction in Albania. Selecting sustainable building materials that ensure structural safety while minimizing environmental impact is crucial. This study focuses on C20 steel, a commonly used construction steel in Albania, investigating its potential for sustainable seismic-resistant construction. Our country has experienced significant seismic activity over the years, including the devastating earthquakes of 1905 in Shkoder and subsequent destructive events in Tepelene, Peshkopi, and Diber-Librazhd regions during the 20th century. Despite some seismic evaluation efforts by the Technical Institute of Engineering (ISTN), there remains a significant gap in seismic assessment and building design within the country [1].

Previous studies in the region have emphasized the importance of construction materials capable of robust mechanical performance, can lead to the design of earthquake-resistant structures that prioritize the safety of occupants [4], [5], [6]. This study explores the mechanical properties of locally produced C20 steel. By comparing with European standards, specifically S235JR/S235J2 steel, we aim to provide the current situation of chemical composition and mechanical properties that construction practices in local urban areas. Using C20 steel in residential construction in Albania and the Balkans offers several advantages and disadvantages when compared to other commonly used construction materials. One significant advantage of C20 steel is its exceptional mechanical properties, including high yield and ultimate tensile strengths, which contribute to structural stability and safety, especially in seismic-prone regions. Its robustness and ductility make it a suitable choice for buildings that need to withstand various environmental challenges. Additionally, C20 steel's durability and resistance to corrosion are advantageous in regions with diverse weather conditions. However, there are also disadvantages to consider. C20 steel, while strong, might be costlier than some alternative materials, potentially affecting construction budgets. Moreover, its production process and transportation can have environmental implications, such as increased energy consumption and emissions. Additionally, the slightly lower elongation values of C20 steel, compared to European standards, might require careful design considerations to ensure adequate flexibility in structural elements. Therefore, the choice between C20 steel and other materials should involve a careful evaluation of both the structural requirements and the economic and environmental considerations specific to each construction project in the region. When assessing the specific properties of our C20 steel samples, it's evident that they exhibit stable mechanical



characteristics, making them highly suitable for structural applications. Sample 1 (8 mm diameter) demonstrated a yield strength ( $R_e$ ) of 660.81 MPa and an ultimate tensile strength ( $R_m$ ) of 773.49 MPa. Sample 2 (10 mm diameter) showed a yield strength ( $R_e$ ) of 619.05 MPa and an ultimate tensile strength ( $R_m$ ) of 757.21 MPa, which shows the material's mechanical performance at larger diameters. Sample 3 (12 mm diameter) maintained its constant mechanical properties with a yield strength ( $R_e$ ) of 587.17 MPa and an ultimate tensile strength ( $R_m$ ) of 702.94 MPa.

### Conservation and Materials and Methods

Sustainable construction practices extend beyond material selection. Construction processes often consume significant water resources. Utilizing alternative building materials with lower embodied water content, such as prefabricated elements or locally sourced wood, can be explored. Additionally, implementing rainwater harvesting systems can further reduce reliance on municipal water supplies. To evaluate the mechanical properties of C20 steel, we conducted a series of tests on three sample groups that were collected periodically in the urban areas, as detailed in Table 1.

Table 1. Characteristics of samples during selection and preparation.

Sample groups	Preparation of sample			Dimensions		
	$D_0$ (mm)	P (gr)	$L_c$ (mm)	$L_0$ (mm)	$S_0$ (mm <sup>2</sup> )	$D_0$ (mm)
1, C20	8	103.1	250.9	80	52.36	8.17
2, C20	10	150.2	280	100	68.33	9.33
3, C20	12	378.4	322	120	149.70	13.81

$D_0$  - sample diameter

P - sample weight

$L_0$  - working length of sample.

$L_c$  - sample length

$S_0$  - cross-sectional area

$D_0$  - average diameter of the sample.

The parameters measured before testing include dimensions and cross-sectional area. Following the tests, we calculated the yield strength ( $R_e$ ) and ultimate tensile strength ( $R_m$ ) of the C20 steel samples. Additionally, we determined elongation (A) and reduction area (Z) to assess the material's ductility and toughness, essential qualities for construction materials. Tensile, compression, bending, and shearing tests were carried out on C20 steel specimens using a DLY-30 hydraulic universal testing machine as described in fig. 1. The chemical analysis of the steel followed the guidelines established in SSH EN ISO 4829-1:2018 [3].

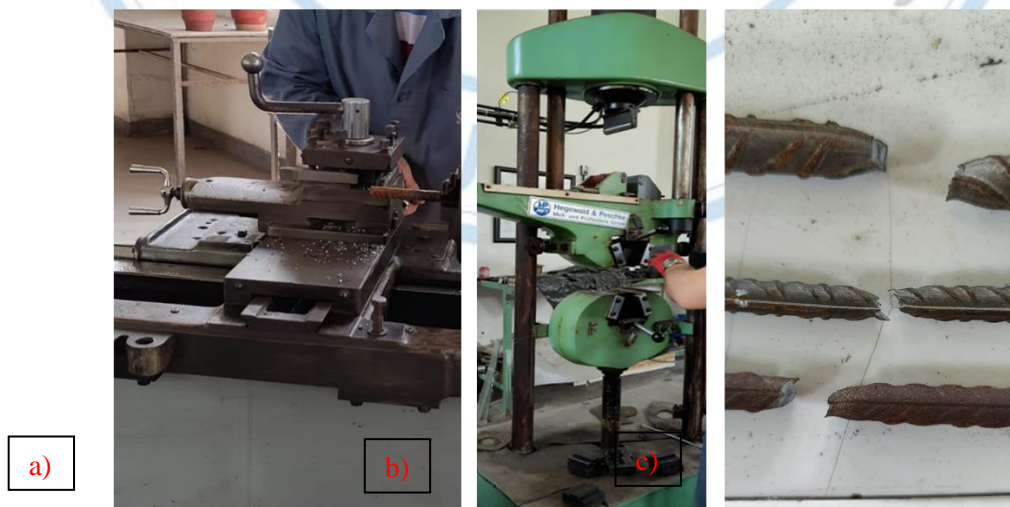


Figure 1. Steel samples a) during preparation according to standard b) during measurements c) after measurements

## Results and Discussion

A comprehensive analysis of the environmental impact of using C20 steel versus alternative construction materials in Albania involves considering several key aspects. Firstly, in terms of carbon footprint, C20 steel exhibits a significant initial carbon footprint due to energy-intensive processes like iron ore mining, smelting, and transportation, resulting in substantial CO<sub>2</sub> emissions. In contrast, some alternative materials, like locally sourced wood or recycled materials, may have a lower initial carbon footprint, requiring less energy for production and transportation. Secondly, regarding energy consumption, C20 steel production is energy-intensive, consuming substantial electricity and resources, contributing to high energy consumption in construction. The same way, alternative materials such as wood often have a lower embodied energy due to local sourcing and reduced processing. Additionally, C20 steel's durability and resistance to corrosion contribute to longer-lasting structures, reducing the need for frequent maintenance or replacement, ultimately lowering its environmental impact. In contrast, alternative materials vary in durability, potentially requiring more maintenance or even replacement over time. Transportation emissions also play a role; steel is often manufactured centrally and transported, potentially emitting greenhouse gases, while locally sourced alternatives may have lower transportation emissions. Steel's recyclability and potential for reuse can reduce its environmental impact. Environmental regulations related to emissions, waste disposal, and sustainable sourcing is important for C20 steel and alternatives. Conducting a life cycle assessment (LCA) considering extraction, production, transportation, use, and disposal would offer a comprehensive understanding of environmental impacts. The choice between C20 steel and alternative materials for construction in main urban areas depends on project-specific requirements of the local area, material availability, and local regulations [1], [8]. The experimental investigation conducted on C20 steel samples provides valuable insights into the material's mechanical properties. To assess the significance of our findings, we have compared our experimental results with values for S235JR/S235J2 steel, a common structural steel in Europe, as well as highlighting the specific properties of our C20 steel samples. In terms of yield strength (Re) and ultimate tensile strength (Rm), our C20 steel samples exhibit a good performance above the values for S235JR/S235J2 steel, which usually range from 235 MPa to 360 MPa (Re) and from 360 MPa to 510 MPa (Rm). For Sample 1 (8 mm diameter), the yield strength (Re) was calculated as 660.81 MPa, and the ultimate tensile strength (Rm) reached 773.49 MPa. For Sample 2 (10 mm diameter), we observed a yield strength (Re) of 619.05 MPa and an ultimate tensile strength (Rm) of 757.21 MPa. Sample 3 (12 mm diameter) exhibited a yield strength (Re) of 587.17 MPa and an ultimate tensile strength (Rm) of 702.94 MPa. These results as described in fig. 2. However, it's important to note that the elongation (A) of our C20 samples was slightly lower than the value of greater than 20% for S235JR/S235J2 steel. Sample 1 displayed an elongation (A) of 18.4%, Sample 2 had an elongation (A) of 18.9%, and Sample 3 showed an elongation (A) of 19.4%. Despite this, it's worth mentioning that the observed values still indicate good ductility and toughness.

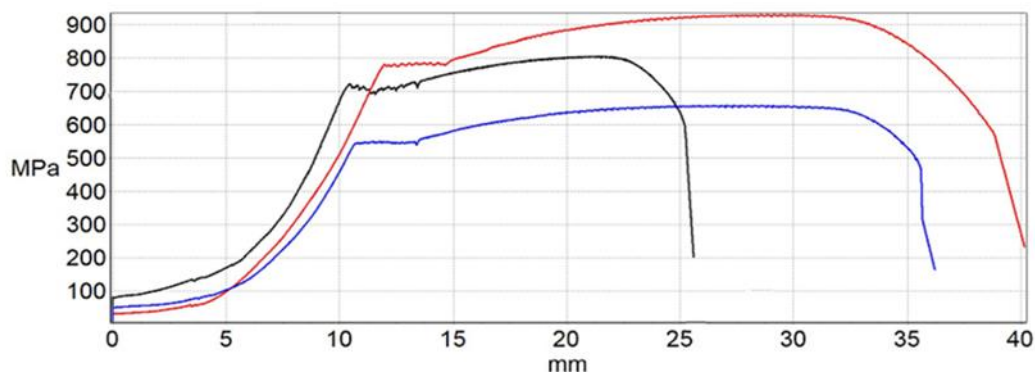


Fig. 2 Presentation Stress – Strain Sample 1 (12 mm), Sample 2 (8 mm), Sample 3 (10 mm) of the periodic produced steel after the application of tensile force at constant speed

The chemical composition of the C20 steel samples, with average values of 0.21% carbon, 0.18% silicon, 0.52% manganese, 0.010% sulfur, and 0.013% phosphorus, can help identify the material's mechanical properties and overall performance. Comparisons with other studies reveal that the observed values are similar with the reported composition of similar steel grades. According to Kah et al. (2015),



who investigated the influence of carbon, manganese, sulphur, phosphorus, aluminium, nitrogen, nickel and other alloying elements in the chemical composition on steel properties, the carbon content in the C20 steel falls within the average range for structural steel, ensuring a balance between strength and formability [10]. Also, the silicon content found in our samples corresponds to the reported values in studies emphasizing the role of silicon as a deoxidizer and its contribution to improved corrosion resistance and durability. Manganese content, improves the steel's strength, wear resistance, and overall microstructural integrity [9], [11].

### Conclusions

This study highlights the importance of considering water resource conservation alongside material selection in sustainable seismic-resistant construction. Further research on the embodied water content of alternative materials and the implementation of water-saving practices during construction can contribute to a more comprehensive approach to environmental sustainability in Albania's building sector.

### Acknowledgements

The authors sincerely thank the Research Laboratory staff of the University of Elbasan.

### References

- [1] A. Fundo, L. Duni, and S. Kuka, "Probabilistic seismic hazard assessment of Albania," *Acta Geod. Geoph. Hung.*, vol. 47, no. 4, pp. 465-479, 2012. DOI: 10.1556/AGeod.47.2012.4.7
- [2] A. A. Adeleke and J. K. Odusote, "Evaluation of Mechanical Properties of Reinforcing Steel Bars from Collapsed Buildings Sites," *Journal of Failure Analysis and Prevention*, vol. 16, no. 4, pp. 587-593, 2016.
- [3] EN ISO 4829-1:2018, "Steel and Cast Iron - Determination of Total Silicon Contents - Reduced Molybdsilicate Spectrophotometric Method - Part 1: Silicon Contents Between 0.05% and 1.0%", SSH, 2019.
- [4] M. Dajko, "Evaluation of Seismic Pounding between two Adjacent Reinforced Concrete Buildings from Albanian Practice," in 14th International Balkans Conference on Challenges of Civil Engineering, BCCCE, Tirana, Albania, 2020.
- [5] C. Papazachos and C. Papaioannou, "The macroseismic field of the Balkan area," *Journal of Seismology*, vol. 1, no. 3, pp. 181-201, 1997. DOI: 10.1023/A:100970911299
- [6] CEN, Eurocode 8: Design of Structures for Earthquake Resistance—Part 1: General Rules, Seismic Actions and Rules for Buildings, European Committee for Standardization (CEN), Brussels, Belgium, 2004.
- [7] M. Guri, N. Vesho, and A. Marku, "Ferrocement Composites for Strengthening of Existing School Structures in Albania," *International Journal of Scientific Research in Civil Engineering*, vol. 4, no. 5, pp. 104-107, 2020.
- [8] S. Xing, X. Zhang, and J. Gao, "Inventory analysis of LCA on steel- and concrete-construction office buildings," *Energy and Buildings*, vol. 40, no. 7, pp. 1188-1193, 2008. DOI: 10.1016/j.enbuild.2007.10.016
- [9] M. M. Rafi, S. H. Lodi, and A. Nizam, "Chemical and mechanical properties of steel rebars manufactured in Pakistan and design implications," *Journal of Materials in Civil Engineering*, vol. 25, no. 7, pp. 913-920, 2013. DOI: 10.1061/(ASCE)MT.1943-5533.0000812
- [10] P. Kah, P. Layus, J. Martikainen, Influence of alloying elements on the low-temperature properties of steel. The 25th International Ocean and Polar Engineering Conference, Kona, Hawaii, USA, paper # ISOPE-I-15-146 (2015)
- [11] B. N. Venturelli, G. Tressia, and E. Albertin, "Effect of manganese content on the wear resistance and impact properties of Hadfield steel," Technical contribution to the 51° Seminário de Fusão, Refino & Solidificação de Metais, part of the ABM Week 6th edition, São Paulo, SP, Brazil, June 7-9, 2022.



## Using Machine Learning Models to Evaluate Corporate Social Responsibility Audits in Turkey

Ayşem Ece YALÇINKAYA<sup>1\*</sup>, Ali Rıza FİRUZAN<sup>2</sup>

<sup>1</sup>34025, Istanbul, Türkiye

<sup>2</sup>Dokuz Eylül University, Faculty of Science, Department of Statistics, Department of Operations Research, 35390, Izmir, Türkiye

\*Corresponding author e-mail: aysemece@gmail.com

### *Abstract*

*The emergence of environmental and social risks has increased the demand for international corporate social responsibility (CSR) and sustainability as production and trade networks expand to meet growing consumption due to globalization, rapid technological development, crises and disasters. A CSR system had become increasingly mandatory for companies that want to participate in sustainable supply chains. In this study, only CSR audit report data from independent ethical trading platforms with a scoring system that can be requested by the brand that is the owner of the supply chain is used. The data on CSR performance and business performance in the audit reports of 163 small and medium-sized enterprises exporting to European countries, which were part of the CSR audit in the period 2018-2020, were included in the analysis. The Python programming language and the Pycaret library were preferred in order to create an effective machine learning (ML) model to assess the relationship between CSR and business performance, and to identify the most important characteristics of CSR. Using a ML model based on regression and correlation analysis, the CSR system is analysed on the basis of economic, environmental and social dimensions. The model selection process used feature engineering with error measures that measure the predictive performance of the model, such as Mean Square Error (MSE), Root Mean Square Error (RMSE), Mean Absolute Error (MAE), Root Mean Square Log Error (RMSLE), Model Accuracy Ratio ( $R^2$ ), and error measures that mathematically minimize the loss functions. As a result of the analysis, according to the Adaboost algorithm, which produces the best model with an accuracy rate of 82.6%, it was determined that there is no relationship between business performance and the CSR system and that there are 9 characteristics under 4 main headings that need to be considered to ensure the success of the CSR system. The aim of the study is to contribute to the efficiency and effectiveness of CSR in all sectors.*

**Keywords:** Machine Learning, Pycaret, Corporate Social Responsibility Audit, Business Performance.

### **INTRODUCTION**

Globalisation, resulting from increased trade after the industrial revolution and world wars, and technological advances, accelerated by the disasters that shook the world, have led to a further expansion of supply chain networks. At the same time, the concepts of corporate sustainability (CS) and corporate social responsibility (CSR) began to gain traction in supply chain management (SCM) to address the social and environmental problems caused by these developments (Baker et al., 2016; Carroll and Brown, 2018; Rodriguez-Gomez et al., 2020). Since the 2000s, brands have begun to request CSR reports that include non-financial data, as well as financial reports, in order to select their supply chain stakeholders and to measure the overall performance of their stakeholders in supply chain networks throughout the supply chain (Baker et al., 2016). Beyond financial reporting, measuring performance on dimensions such as human rights and the environmental impact of worker empowerment has been challenging. This has led to the emergence of CSR management systems, CSR standards and sustainability indices based on international measurement, reporting and quality management systems.

In many studies in the literature, various performance measurement approaches related to CSR have been developed (Figge et al., 2002; Kaplan and Norton, 2005; Asiaei et al., 2021) and measurement models such as ESG have been created (Balatbat et al., 2012; Laermann, 2016; He et al., 2022) and country-specific CSR indices, including CSR performance, have been developed (Davis, 2005; Stanislavska et al., 2010; Höllerer, 2012; Tilakasiri, 2012; Avram and Avasilcai, 2014; Martinez-Conesa et al., 2017; Wekesa and Kimutai, 2018; Yu and Liang, 2020; Fatima and Elbanna, 2022). In the last twenty years, CSR management systems and standards created by common networks, called ethical trading platforms, established by non-governmental organizations (NGOs) to solve problems and analyse risks in environmental and social issues at a global level increase the importance of cooperation and information flows in the supply chain.

The CSR is a management system that requires continuity and ensures that a company is socially, environmentally and economically accountable and transparent to its employees, stakeholders and society. It is claimed that the content and scope of current international CSR management standards, especially in terms of application, are quite complete, are constantly updated with stakeholder participation, are based on models that provide strategic, comprehensive management of relevant parties, and are applicable. At the same time, it is seen that there are control mechanisms in practice where the performance of the system is constantly measured in terms of SCM (Berzau, 2011; Amfori, 2022). The performance of the CSR system is reported by independent organizations through independent third-party audits carried out on behalf of ethical trading platforms according to these standards and is recorded on the platforms. Reporting through these platforms, which has become mandatory in line with the 2030 Sustainable Development Goals, ensures that not only large companies but also small and medium-sized enterprises in developing countries are constantly monitored. Therefore, it can be concluded that organizations can meet their needs and requirements to new models can not recommended but can be developed. CSR standards and audits, created by international platforms that enable the application of the CSR concept to businesses and whose weightings are updated every period, are used as a tool to measure the effectiveness of CSR. It has become important to identify the most important CSR issues in companies, especially on a country or regional basis, and to examine their relationship with business performance. For this reason, this study aims to examine the most important points regarding CSR practices within the borders of Turkey in terms of supply chain and investigate their impact on business performance.

The study's analysis was based on a standard audit that has a scoring rating among CSR audit standards, cannot be requested voluntarily by manufacturers, and is relatively difficult, was selected. In the 2018-2020 period, the audit reports of 163 small and medium-sized companies that were included in the CSR audit called Amfori BSCI and focused on exports to European countries were examined. In the first stage, the research problem was defined and then the data in the reports were made ready for analysis using IBM SPSS 26. Validity and reliability analyzes of the questions in the entire report were conducted. In the reports, descriptive statistics of items indicating business performance other than CSR performance were calculated. The second stage, since the number of variables showing the CSR and business performance of 163 companies was quite high, was used a machine learning (ML) model based on regression and correlation analysis. ML algorithms analyse data, identify patterns and make predictions using mathematical models and algorithms. These algorithms can be used to create regression models, decision trees, random forests, support vector machines and many other models. In addition, ML algorithms can continuously learn from analyzed data and make improvements in the models they create, making their use in areas where data constantly changes gains importance. In summary, ML is a valuable tool in the field of statistics as it provides an efficient way to perform model building, make deeper predictions, and better decision-making with improved accuracy rates even in complex and dynamic data environments. And also ML algorithms are expected to play an increasing



role in business, particularly in supply chain management and sustainability.

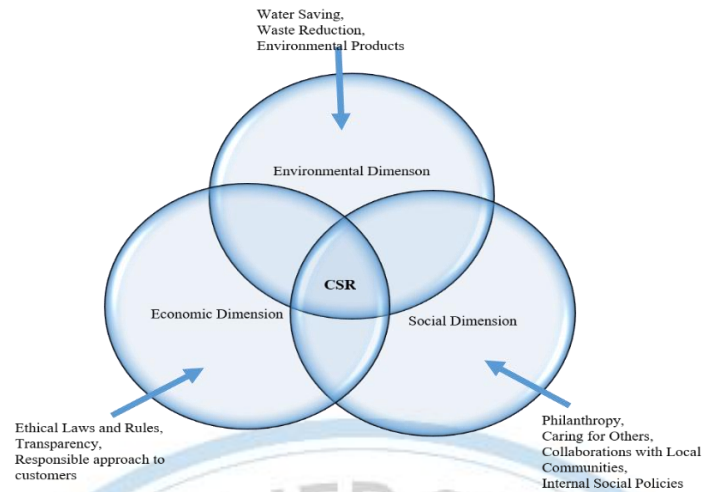
ML models based on regression and correlation analysis have been used to model causal relationships, understand the relationship between variables and make predictions based on this relationship, especially to determine which factors are more strongly related to audit results and how this relationship changes. The classification feature were utilized from the Pycaret library in the Python programming language and, a supervised ML module used to categorize items into classes using various algorithms. The PyCaret is a tool that is built around the Python programming language and enables quick comparison of multiple common ML models to identify the best model (Ali, 2020; Iqbal, Biswas and Urba, 2021). The selection process of models created with Pycaret, have been taken into account the accuracy rate of the model ( $R^2$ ), and also error measures such as Mean Square Error (MSE), Root Mean Square Error (RMSE), Mean Absolute Error (MAE), and Root Mean Square Log Error (RMSLE). These error measures are mathematically minimizing the loss functions that measure the model's prediction performance were used. The results have showed that the Adaboost algorithm produced the most accurate model. The next stage has been to apply a feature engineering to the selected model. After this stage, It has been again analysed and as a result, it has been again determined that the adaboost algorithm produced the best model with the best accuracy rate. On the basis of this algorithm, it has been determined that there is no relationship between business performance and the CSR system in Turkey, and that 9 items under 5 main headings need to be taken into consideration in order for the CSR system to achieve optimum success. There are not enough studies in the literature in which the data in the CSR audit reports carried out in practice are examined in detail and evaluated with ML models. For this reason, it is expected to contribute to the efficiency and effectiveness of companies in all sectors that implement the CSR system within the borders of Türkiye.

## **MATERIAL AND METHODS**

### **Material**

CSR is a concept that includes activities carried out by institutions and organisations based on transparency, ethical, moral, and environmental values and principles. The beginning of the history of CSR is accepted as the death penalty by King Hammurabi in 1700 BC, when the negligence of the construction workers, innkeepers, and farmers in Mesopotamia caused death or serious distress (Tilakasiri, 2012). The increasing interest in the concept of CSR and the obligations imposed in practice in the last two decades have led to the rise of to the rise of CSR (Clarkson, 1995; Carroll, 1999; McWilliams and Siegel, 2001; Baker et al., 2016; ISO, 2022; Govindan, 2022). CSR is a concept mainly driven by multinational companies or NGOs, and there is a general trend to extend it to national companies (Stanislavska et al., 2010). It is generally accepted that companies and organisations with CSR systems have a better chance of survival and success in the long term. CSR programmes have a cascading effect in terms of traceability on the supply chain and aim to fill many of the gaps in countries where there is little or no legal regulation of working conditions. There are many initiatives and codes of conduct developed by NGOs in different countries, as well as sectoral codes and international frameworks (Code of Conduct / COC). CSR activities are located at the intersection of social, economic, and environmental approaches. Internationally developed and accepted codes of conduct, standards, and norms, as well as sectoral or national standards and codes of conduct, are established according to the model shown in Figure 1.





Source: Höllerer, 2012:64

Figure 1. CSR key dimensions

Eight basic international standards, which are the most common in practice, have been adopted to assess all CSR activities of supply chain stakeholders. The SA8000 Social Responsibility Standard, created by a global USA nonprofit NGO in 1997 that promotes human rights in the workplace, and last updated in 2021; the ETI Code of Ethics, created in 1998 by the NGO called ETI in the UK and updated in 2021; the WRAP3-22 Standard, created in 2000 by the American Apparel and Footwear Association in the USA and updated in 2022; the Amfori BSCI (Business Social Compliance Initiative Standard), created in 2010 by the Belgium-based FTA (Foreign Trade Association) in the UK and updated in 2021; SMETA (Sedex Members Ethical Trade Audit), created by the SEDEX platform in 2010 and updated in 2023; ISO 26000 (Social Responsibility Guidelines), created by the Swiss ISO in 2010, IQNet SR 10 Social Responsibility Systems, created by IQnet in Switzerland in 2011 and updated in 2015; The WCA standard, issued by the WCA platform created by the Intertek Certification organisation in London in 2014 and updated in 2021, are the main international CSR standards. They all correspond to management system standards such as ISO 9001, ISO 14001, ISO 45001, and ISO 37001. The CSR management system standards based on international standards that are most common used in Turkey in all organisations in all sectors and regions, and audited only by auditors registered with the Association of Professional Social Compliance Auditors (APSCA) are presented in Table 1 (Theapsca,2022). The principles are summarized comparatively.

Table 1: International CSR standards code of conduct and standard main items

CSR Standards	Number of Items	Code of Conduct that the Parties Commit to Comply with	Performance Area / Items	Requesting and Scoring	Explanations
SA8000 Social Responsibility	9	Eti Code of Conduct 1. Workers are chosen according to their free will. 2. The right to unionise and to make collective bargaining agreements. 3. Occupational health and safety. 4. Child labor is not used. 5. Minimum living wage. 6. Working hours should not be excessive. 7. No discrimination is applied. 8. Regular employment. 9. No very abrasive or inhumane practices are allowed.	*Child Labor Prevention * Prevention of Forced * Occupational Health and Safety * Freedom of association and collective bargaining rights * Discrimination * Disciplinary * Working hours * Wages * Management system	Each organisation can request an audit for itself. No Scoring: It is left to the evaluation of the parties reading the report.	Organisations as buyers and sellers can request this for themselves.

**V. International Applied Statistics Congress (UYIK - 2024)**  
**İstanbul / Türkiye, May 21-23, 2024**

**Table 1** continued.

CSR Standards	Number of Items	Code of Conduct that the Parties Commit to Comply with	Performance Area / Items	Requesting and Scoring	Explanations
Amfori BSCI: Business Social Compliance Initiative	13	Amfori BSCI Principles *The Rights of Freedom of Association and Collective Bargaining * Fair Remuneration * Occupational Health and Safety * Special protection for young workers * Prevention of Payment of Debts by Labor * Ethical business behaviour * No discrimination * Reasonable / Decent working hours * Prevention of child labour * No precarious employment * Protection of the environment	Amfori BSCI Performance Areas 1. The Rights of Freedom of Association and Collective Bargaining 2. No bonded labour 3. No precarious employment 4. Fair remuneration 5. Ethical business behaviour 6. Protection of the environment 7. Occupational Health and Safety 8. No discrimination 9. Social management system and cascade effect 10. Decent working hours 11. Special protection for young workers 12. No child labour 13. Workers' involvement and protection	It is only requested by registered brands that want sub-suppliers to be audited. The only scoring is CSR auditing: A- Elite B- Good C- Acceptable D- Insufficient E- Unacceptable F- Zero Tolerance	It is the only organisation that has a mapping system that will allow the brands that are members of the platform to determine the most suitable supply chain. In addition, it is the only type of audit that requires the audited supplier to audit and report its suppliers in detail according to the same rules due to the gradual/ cascade effect.
SMETA 6.1: Sedex Members Ethical Trading and Audit	12	Eti Code of Conduct	*Freedom of employment *Freedom of association *Occupational health and Safety *Child and youth labor *Living Wages Payments and benefits *Working hours *Discrimination *Regular employment *Preventing rude and harsh behaviour *Right to work *Subcontractors and sub-producers *Business ethics *Environmental protection	Each organisation can request an audit itself. No Scoring: It is left to the evaluation of the parties reading the report.	Organisations as buyers and sellers can request this for themselves.

**Source:** Edited by the author.

The performance of the CSR system is reported through independent third-party audits conducted by independent organisations according to these standards and have been seen to be recorded on the platforms. The platforms, which are constantly renewed with updates such as social fingerprinting and smart database applications, have aimed to offer the most geographically appropriate supply chains consisting of companies that have achieved successful results in the supply chain to brand companies and relevant organisation after successful audit processes. This should also help optimise the supply chain and reduce risk. Through these platforms, which have become mandatory in line with the 2030 Sustainable Development Goals, not only large companies, but also small and medium companies in

developing countries have established a CSR system and have been continuously monitored. It has been seen that claim that the content and scope offered by the existing international CSR management standards are quite complete, continuously updated with stakeholder participation, based on models that ensure strategic and comprehensive management of the relevant parties, and applicable to corporate sustainability management. Therefore, it can be concluded that they can meet the needs and requirements of organisations and that new models cannot be proposed, but can be developed. In practice, it is seen that companies with an acceptable level of CSR performance are included in the chain and can remain in the chain by ensuring the continuity of their operations. One of the challenges faced by suppliers in the chain is the implementation of CSR activities. For these reasons, the aim of the study is examining existing CSR standards with audit reports is to determine the most important CSR elements and dimensions so that companies can achieve faster and positive results and to determine whether there is a relationship between the CSR system and business performance.

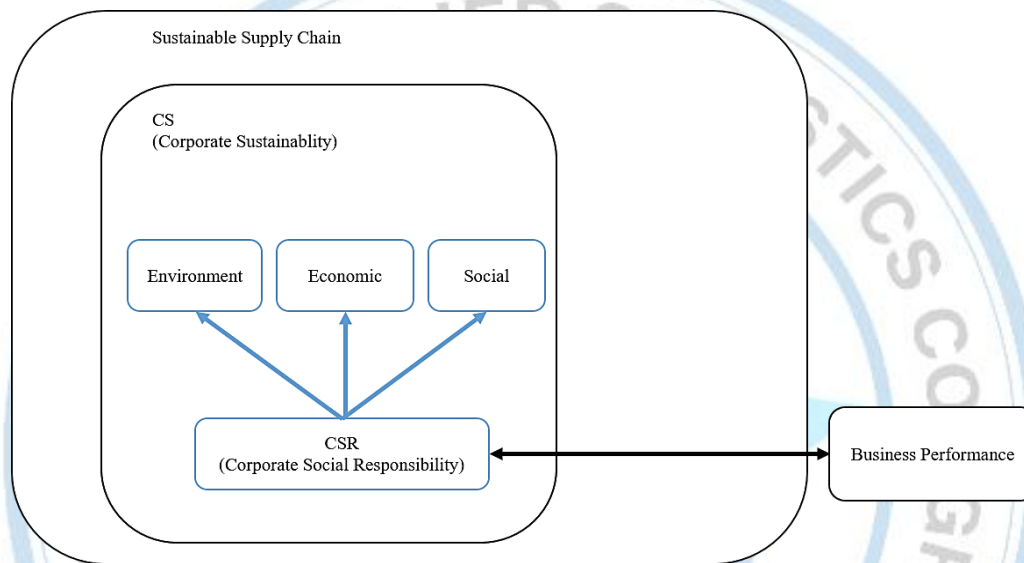


Figure 2. Research model

## Methods

### *The Collection of the Data*

For the analysis of the study, a standard audit that has a scoring rating among CSR audit standards, cannot be requested voluntarily by manufacturers, and is relatively difficult, was selected. The population of the research consists of 800 companies that have passed Amfori BSCI audit within the borders of Turkey in the 2018-2020 period and export to 89% of which are in European countries (Amfori, 2023). According to the purpose of the investigation, the study sample was in the 2018-2020 period, the audit reports of 163 small and medium-sized companies that were included in the CSR audit called Amfori BSCI and focused on exports to European countries. In the first stage, the research problem was defined and then the data in the reports were made ready for analysis using IBM SPSS 26. In the reports, descriptive statistics of items indicating business performance other than CSR performance were calculated. Validity and reliability analyzes of the questions in the entire report were conducted. In the second stage, the CSR performance of 163 companies was analyzed based on economic, environmental and social dimensions using a regression model-based ML model. Correlation analysis was applied using the Python programming language Pycaret library to determine the relationships between items showing CSR performance and information showing business performance. The dependent variable is the audit result and the first of the two groups of independent variables are the 81 audit questions (13 groups) that determine the audit result / score and the second group is the business performance that consist 12 questions.



Statistical Analysis

The analysis uses the Python programming language and Pycaret library to model causal relationships, understand the relationship between variables and make predictions based on this relationship, i.e. to determine which factors have a stronger relationship with audit results and to perform analyses. In other words, the main purpose of using ML algorithms is to better distinguish the factors that influence audit results and to determine if there is a relationship between CSR performance and business performance.

PyCaret, the Python program we preferred for our analysis, is a supervised ML module whose classification function is used to classify items using different methods and algorithms (Ali, 2020; Chang et al., 2023). PyCaret's regression module includes more than 25 algorithms, 10 graphical methods and advanced techniques such as hyperparameter tuning, combining or editing to analyse the performance of models. In this study, all steps of the PyCaret library workflow created by Ikbal and Biswas in 2021 and shown in Figure 3, except for the transfer to the cloud, were followed (Ikbal, Biswas and Urba, 2021).

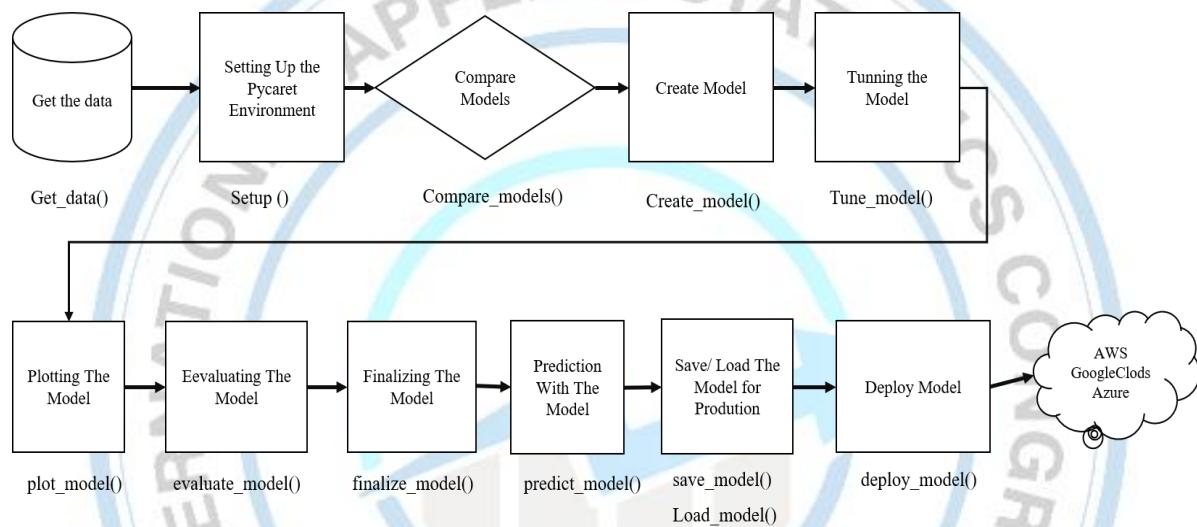


Figure 3. Pycaret library workflow in Python

In the analysis, pandas, numpy, matplotlib, seaborn, Sweetviz, regression packages and the necessary functions in these packages were used and a ML model was created. Data visualization, missing data detection and parameter reduction processes were carried out, and then, while creating the model, 80% of our data set was divided as training data and 20% as test data. The best regression model was analyzed comparatively and the selected regression model was tested and evaluated using the test data. For the accuracy test, the prediction accuracy of the models was compared using the differences between predicted and actual values based on the predicted model, prediction errors and performance indicators standardised by some formulas. The main performance indicators in Table 2, which are used in the performance evaluation of the model in artificial neural networks and ML methods, are the statistics used in the measurement of the prediction accuracy/prediction performance of the models with error measures that mathematically minimise the loss functions (Karasu et al., 2018, Gültepe, 2019).

**Table 2.** Statistics used to measure the prediction accuracy / prediction performance of models

<b>Mean Squared Error (MSE)</b>	$MSE = \sum_{t=1}^n \frac{(u)^2}{n} = \frac{1}{n} \sum_{i=1}^n (y_i - \hat{y})^2$	It measures how far the data are from the predicted values of the model. Shows sensitivity to outliers. It is an absolute measure. MSE can also be misleading when residuals are less than 1.
<b>Root Mean Squared Error (RMSE)</b>	$RMSE = \sqrt{\sum_{t=1}^n \frac{(u)^2}{n}} = \frac{1}{n} \sqrt{\sum_{t=1}^n (y_i - \hat{y})^2}$	It is similar to the Euclidean Distance between the estimate and the actual value. It is calculated by taking the square root of the MSE measure. It is the average distance of the points from the best fit line or model, and the smaller it is, the more accurate the model is.
<b>Mean Absolute Error (MAE)</b>	$MAE = \sum_{t=1}^n \frac{ u_t }{n}$	It is similar to the Manhattan distance between the forecast and the actual value. While RMSE and MAE are both measures of distance, they often give different measurements and this makes a greater difference in higher dimensions.
<b>Mean Absolute Percentage Error (MAPE)</b>	$MAPE = \frac{\sum_{t=1}^n \frac{ u_t }{Y_t}}{n} * 100$	It is used to normalize or weight the errors with the inverse of the true observation value. It can be said that it is appropriate to use when the aim is to minimize the relative error rather than the absolute.
<b>Root Mean Squared Log Error (RMSLE)</b>	$RMSLE = \sqrt{\frac{1}{n} \sum_{t=1}^n (\log(p_i + 1) - \log(a_i + 1))^2}$	It is the root mean square error of log-transformed estimated and log-transformed real values. However, if there is any negative value, it is not suitable.
<b>Accuracy rate of the model (R<sup>2</sup>)</b>	$R^2(y, \hat{y}) = 1 - \frac{\sum_{i=1}^n (y_i - \hat{y})^2}{\sum_{i=1}^n (y_i - \bar{y})^2}$	It shows the proportional improvement of the prediction compared to the average model. It is interpreted as the proportion of the total variance explained by the model and is considered as a measure of relative fit. As it is based on certain assumptions, this coefficient is not mathematically valid if these are violated. The MSE, RMSE and MAE indicators are not based on assumptions and only measure the average distance of the prediction from the true value.

**Source:** Edited by the author.

In a ML model, the RMSE value, a quadratic metric commonly used to find the distance between predicted and actual values, measures the size of the error. In this study, the RMSE value is chosen because it is differentiable, easy to compute, and is a symmetric and quadratic loss function suitable for Gaussian noise. More generally, minimizing RMSE and RMSLE provides a convergence for the conditional expected value of the next observation to be estimated, given the explanatory variables. After final model selection based on accuracy rate, model hyperparameters are optimized after the model is created and validated. Tuning code is run to optimize the hyperparameters that gave the best performance. Then, the analysis is repeated by applying feature engineering and the final model with the highest accuracy is achieved.

## RESULTS

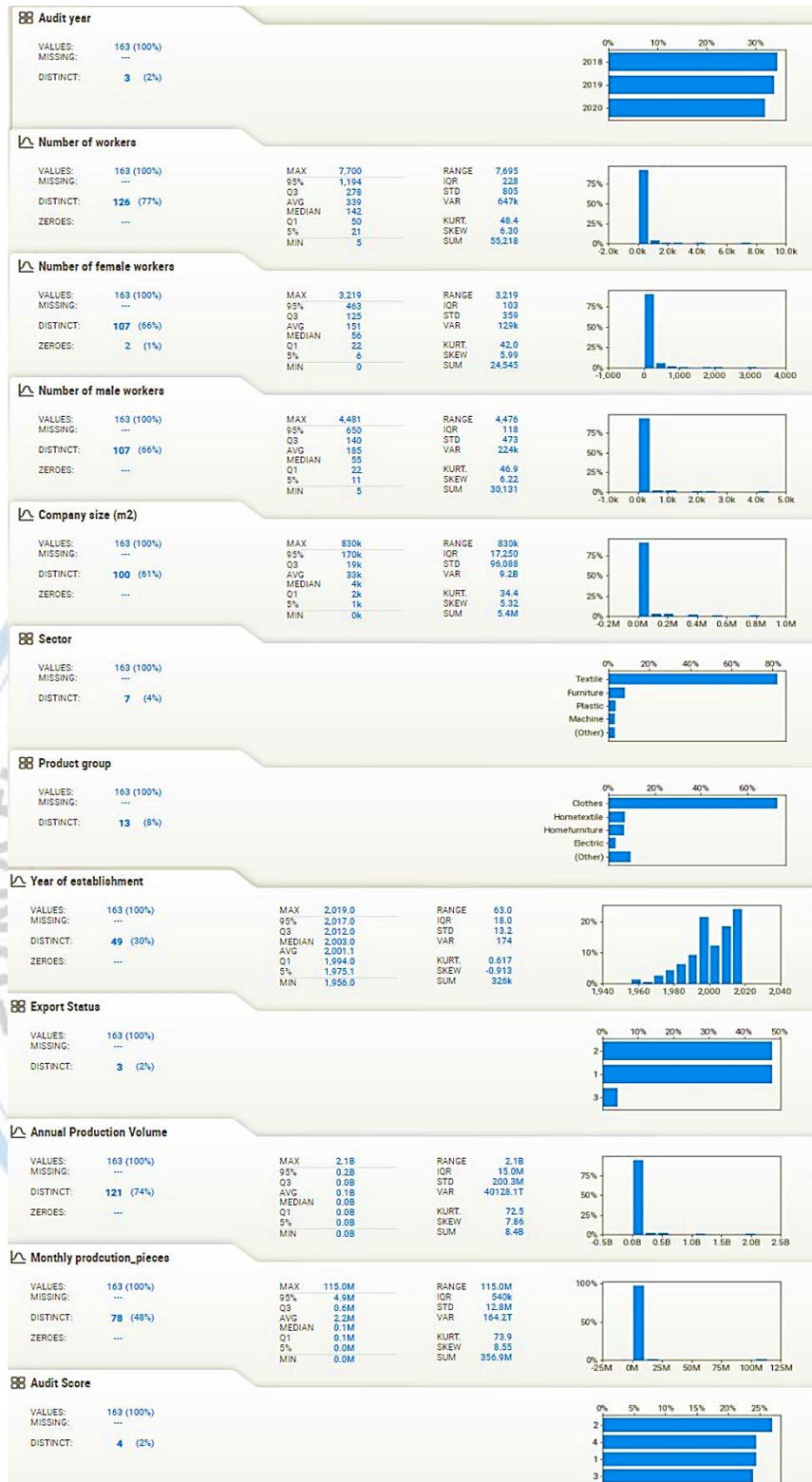
There is a checklist consisting of 13 groups and 81 questions, called the performance area (PA), which makes it possible to obtain the audit result in these reports. The questions were coded using the IBM SPSS 26 programme according to a 5-point Likert scale as 1: "Not appropriate", 2: "Partially not appropriate", 3: "Out of scope", 4: "Partially appropriate", 5: "Appropriate", and reliability analyses were applied. The reliability measure obtained as a result of the analysis of the items in the audit question list, the value of the Cronbach alpha coefficient (0.978) was very close to 1. This value shows that the list of questions coded according to the 5-point Likert scale, consisting of 81 questions answered for 163 companies, is "highly reliable". In the next step, Python programming language and Pycaret library were used to determine the most important elements affecting the audit result and the relationship between the audit result and business performance. In the data analysis, firstly, a data set containing 163 companies was prepared. Data visualization, missing data detection and parameter reduction were performed, and then, while creating the model, 140 of our data set was divided as training data and 23 as test data. By training with the data of 140 companies, the most important items affecting the audit result and the relationship between business performance and CSR were analyzed. Finally, the best regression model was analyzed comparatively and the selected regression model was tested and evaluated using the data of 23 companies.

Analysis steps; these include loading libraries, loading and defining data, correlation analysis, data visualization, data control and comparative training of models, model selection according to hyperparameters, determining the best parameters of the selected model and hyperparameter optimization, determining the model according to its accuracy rate and verifying it with test data. In the first step, the necessary code was entered to transfer the IBM SPSS data file to Python, and then the necessary packages such as pandas, numpy, matplotlib, seaborn, Sweetviz, regression packages were called. The data file was loaded, and since the column headings represented variables, the command was given to transfer the data in the data file according to columns, and the columns/variables were checked by calling the screen. In the next step, the Seaborn package was called to visualize the data, the features were entered and the correlation matrix was created. Additionally, the mask command has been added to prevent missing data. Sweetviz library, an opensource Python library for creating high-density visualizations, was used to initiate exploratory data analysis (EDA) with a small amount of code. The output is a completely independent HyperText Markup Language (HTML) implementation. The HTML file as output is included in Figure 4.

This produced distributions and histogram graphs of the dependent variable, the audit outcome dependent variable, and the bussiness performance variables included in the report. In the data set obtained from the Amfori BSCI CSR audit reports, firstly the audit result determined as the dependent variable and the distribution of the data according to the performance characteristics of the companies, excluding audit items, have been reviewed. According to in Figure 4, in the dataset, 44 (27%) of the 163 companies were founded between 1991-2000, 40 (24.5%) between 2001-2010 and 49 (30.1%) after 2010. In terms of audit years, 34.4% (56) of the companies were audited in 2018, 33.7% (55) in 2019 and 31.9% (52) in 2020. According to number of workers; 58.3% of the companies have 100 or more workers, 24.5% (40) have between 0 and 50 workers and 17.2% (28) have between 50 and 100 workers. While 31.9 % of companies (52) have 100 or more female workers, 35 % have 100 or more male workers. Also, of the 163 companies in the dataset, 40.5 % (66) have a floor area between 450 and 3,000 square metres and 29.4 % have a floor area of 10,000 square metres or more. According to the the export status in the data set; 47.9% (78) only export, 47.9% (78) export and sell domestically, and 4.3% (7) only sell domestically and prepare for export.



## V. International Applied Statistics Congress (UYIK - 2024) İstanbul / Türkiye, May 21-23, 2024



**Figure 4.** Histogram graphs of audit results and other variables related to firm's performance

Data consisting of 163 rows and 93 columns were shown in a table, the command to round decimal numbers was entered, and an accuracy rate was defined to measure the success of the model. Definitions were made about the parts of the data set to be trained and the parts to be tested. 23 reports are reserved for testing and 140 reports are reserved for training data. The model configuration function is defined in the Pycaret regression library. The aim is to determine the best model by comparing all regression models according to the RMSE value, which is one of the main performance indicators. In this study,

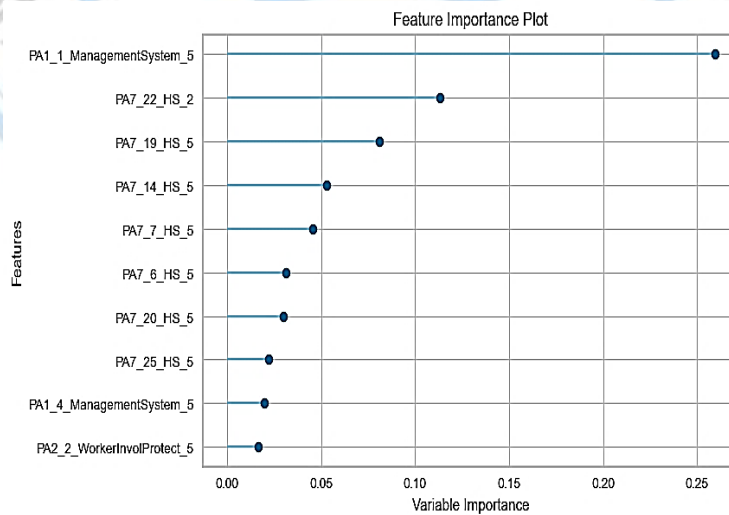
**V. International Applied Statistics Congress (UYIK - 2024)**  
**İstanbul / Türkiye, May 21-23, 2024**

the algorithm with the highest  $R^2$  and the lowest RMSE and RMSLE was identified as the adaboost regressor (adaptive boosting) in the first stage of construction of the regression model and the comparison of the model according to RMSE. Model comparison results are given in Table 3. AdaBoost represents a viable model and provides high classification success. In the Adaboost algorithm, the training data is first trained with the weakest student and after training, the incorrectly predicted training data is weighted and retrained. In other words, the strongest weak classifier is determined according to the classification success in each iteration, and a probability distribution function is obtained by changing the weights. By repeating this process, the strongest weak classifiers are combined according to the determined iteration and a high performance classifier is created.

**Table 3.** Model evaluation according to the prediction accuracy

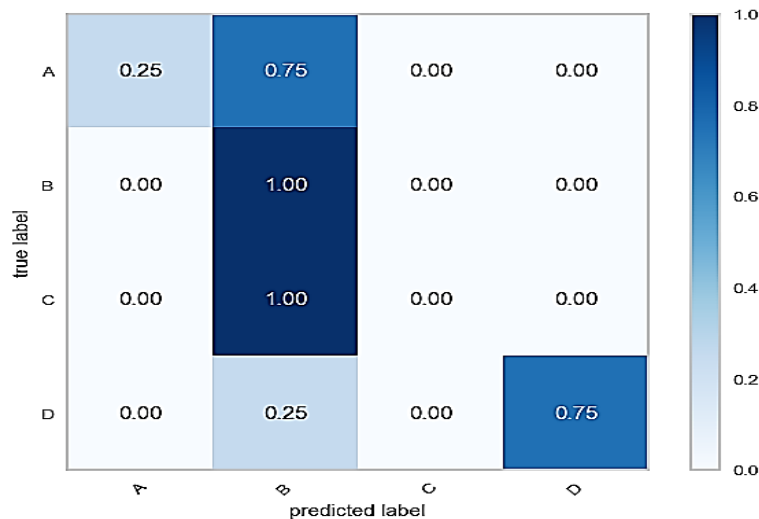
	<b>Model</b>	<b>MAE</b>	<b>MSE</b>	<b>RMSE</b>	<b>R<sup>2</sup></b>	<b>RMSLE</b>	<b>MAPE</b>	<b>TT (Sec)</b>
<b>ada</b>	AdaBoost Regressor	<b>0.0211</b>	<b>0.0122</b>	<b>0.0591</b>	<b>0.5955</b>	<b>0.0241</b>	<b>0.0185</b>	<b>0.0350</b>
<b>gbr</b>	Gradient Boosting Regressor	0.1568	0.1058	0.2657	0.3591	0.0817	0.0859	0.0420
<b>rf</b>	Random Forest Regressor	0.2090	0.1015	0.2797	0.3574	0.0886	0.1135	0.0620
<b>lightgbm</b>	Light Gradient Boosting Machine	0.2161	0.1021	0.2808	0.3582	0.0924	0.1207	0.0170
<b>et</b>	Extra Trees Regressor	0.1648	0.2288	0.3892	0.3923	0.1195	0.0796	0.0560
<b>dt</b>	Decision Tree Regressor	0.1786	0.3214	0.4387	0.4433	0.1313	0.0804	0.0060
<b>omp</b>	Orthogonal Matching Pursuit	0.3435	0.2852	0.5015	0.2459	0.1563	0.1713	0.4870

After the initial model selection process, the model score is checked according to the test data and the final model values are obtained by finalizing the model. The features that most affect the dependent variable and performance variables and increase the model performance in the final model are plotted in Figure 5.



**Figure 5.** Graphic of the most important features in the final model

The accuracy rate of the final model was obtained as 60.86%. A confusion matrix was created to evaluate the validity and performance of the model on the items in Figure 6.



**Figure 6.** Confusion matrix for the first model

In the next stage, the model hyperparameters optimize after the model was built and validated. The model hyperparameters are generated as a result of training and optimized with the data, while the model parameters are learned from the data. This is an adjustable parameter in an optimisation algorithm of ML and statistics. It had been determined the step size at each iteration as it moves towards the minimum loss function. The accuracy of the prediction model adjusted with the tune model function as seen Table 4 was obtained as 56.52% . Since the results were not sufficient, the hyperparameter process was continued iteratively and the best model was recorded with a learning rate of 0.5. The accuracy of the recorded model was found to be 60.86%. Therefore, regression was run for the second time on all data, the best model was created according to the RMSE value, and the main features that increased the model performance were drawn. As a result, the algorithm that produced the best model had been again the adaboost algorithm.

**Table 4:** Tune model / Configuring hyperparameters that affect model performance in the final model

Fold	MAE	MSE	RMSE	R <sup>2</sup>	RMSLE	MAPE
0	0.0000	0.0000	0.0000	0.9998	0.0000	0.0000
1	0.0000	0.0000	0.0000	0.9989	0.0000	0.0000
2	0.0000	0.0000	0.0000	0.9899	0.0000	0.0000
3	0.0056	0.0001	0.0000	0.9998	0.0049	0.0034
4	0.0760	0.0641	0.0122	0.0000	0.0793	0.0362
5	0.0000	0.0000	0.2533	0.0000	0.0088	0.0067
6	0.0343	0.0045	0.0000	0.0000	0.0372	0.0389
7	0.0288	0.0016	0.0667	0.9946	0.0124	0.0118
8	0.0349	0.0082	0.0400	0.9787	0.0773	0.0527
9	0.1454	0.1429	0.0907	0.8818	0.0844	0.0373
<b>Mean</b>	<b>0.0325</b>	<b>0.0222</b>	<b>0.3781</b>	<b>0.6876</b>	<b>0.0304</b>	<b>0.0187</b>
<b>Std</b>	<b>0.0443</b>	<b>0.0444</b>	<b>0.0841</b>	<b>0.4515</b>	<b>0.0353</b>	<b>0.0192</b>

Following this stage, the performance indicators of the final model were determined. Tuning code was run to optimize the hyperparameters that gave the best performance. The best model was obtained with an accuracy rate of 82.6%. The confusion matrix was checked and this model with a learning rate of 0.2 was recorded as "Best Model 2". In the third attempt, feature engineering was applied and the third question in the third performance field in the audit report was removed from the analysis and the second and first features were combined and included in the analysis. After these procedures, it was seen



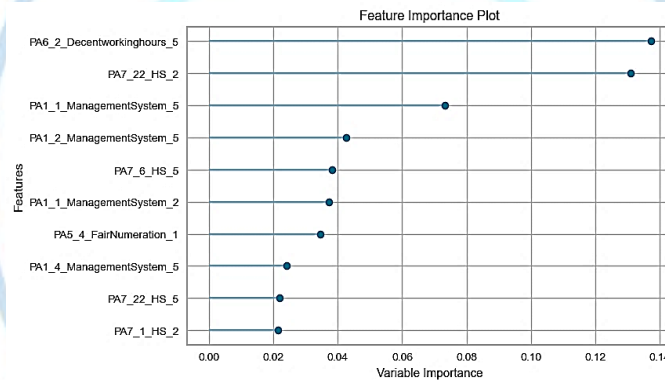
**V. International Applied Statistics Congress (UYIK - 2024)**  
**İstanbul / Türkiye, May 21-23, 2024**

that the adaboost regressor was selected again according to the RMSE values as seen in Table 5. As a result of model tuning processes and confusion matrix and accuracy calculations, the model was registered as "The best model with feature engineering". The learning rate was 0.05 and the accuracy rate was 89.56%.

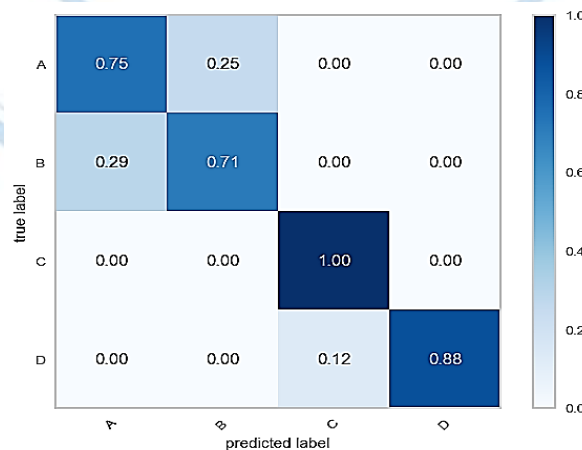
**Table 5:** Model evaluation according to the prediction accuracy after feature engineering

Model	MAE	MSE	RMSE	R <sup>2</sup>	RMSLE	MAPE	TT (Sec)
<b>ada</b> <b>AdaBoost Regressor</b>	<b>0.1919</b>	<b>0.1251</b>	<b>0.3217</b>	<b>0.8896</b>	<b>0.1154</b>	<b>0.1272</b>	<b>0.0300</b>
<b>gbr</b> Gradient Boosting Regressor	0.1836	0.1209	<b>0.3281</b>	0.8940	0.1134	0.1126	0.0340
<b>et</b> Extra Trees Regressor	0.1578	0.1449	<b>0.3533</b>	0.8660	0.1204	0.0947	0.0510
<b>rf</b> Random Forest Regressor	0.2313	0.1599	<b>0.3664</b>	0.8622	0.1270	0.1412	0.0590
<b>lightgbm</b> Light Gradient Boosting Machine	0.2691	0.1682	<b>0.3952</b>	0.8312	0.1360	0.1560	0.0100
<b>dt</b> Decision Tree Regressor	0.1735	0.2068	<b>0.4312</b>	0.7799	0.1520	0.1032	0.0050
<b>omp</b> Orthogonal Matching Pursuit	0.3840	0.3058	<b>0.5402</b>	0.6705	0.1741	0.1879	0.0050

The most important features and confusion matrix graphs for the "best model with feature engineering" are given in Figures 6 and 7.



**Figure 7.** Graphic of the most important features in the the best model with feature engineering



**Figure 8.** Confusion matrix for the best model with feature engineering

The Tune model evaluation result for "Best model with feature engineering" was obtained as seen in the Table 6.

**Table 6.** Tune model / configuring hyperparameters that affect model performance in the best model

**V. International Applied Statistics Congress (UYIK - 2024)**  
**İstanbul / Türkiye, May 21-23, 2024**

with feature engineering

<b>Fold</b>	<b>MAE</b>	<b>MSE</b>	<b>RMSE</b>	<b>R<sup>2</sup></b>	<b>RMSLE</b>	<b>MAPE</b>
<b>0</b>	0.0653	0.0142	0.1193	0.9897	0.0559	0.0615
<b>1</b>	0.3337	0.4165	0.6454	0.7582	0.1682	0.1467
<b>2</b>	0.2222	0.1912	0.4372	0.8127	0.1316	0.1012
<b>3</b>	0.0132	0.0007	0.0265	0.9988	0.0089	0.0066
<b>4</b>	0.0961	0.0459	0.2143	0.8932	0.0807	0.0481
<b>5</b>	0.1251	0.0952	0.3086	0.8774	0.1257	0.1165
<b>6</b>	0.1218	0.0589	0.2427	0.9560	0.0969	0.0862
<b>7</b>	0.2316	0.1535	0.3918	0.9071	0.1591	0.1990
<b>8</b>	0.1334	0.0769	0.2773	0.9418	0.1178	0.1269
<b>9</b>	0.1435	0.0312	0.1768	0.9643	0.0783	0.1225
<b>Mean</b>	<b>0.1486</b>	<b>0.1084</b>	<b>0.2840</b>	<b>0.9099</b>	<b>0.1023</b>	<b>0.1015</b>
<b>Std</b>	<b>0.0872</b>	<b>0.1174</b>	<b>0.1667</b>	<b>0.0736</b>	<b>0.0460</b>	<b>0.0515</b>

It was determined that the Adaboost algorithm generated the optimal model in terms of accuracy. It has determined that 9 items under 4 main headings need to be taken into consideration in order for the CSR system to achieve optimum success in this algorithm. Created according to the final model, the most important variables are shown in the graph in Figure 7. According to the audit reports, there are four questions on occupational health and safety (PA7), one question on reasonable working hours (PA6), one question on fair wages (PA5) and three questions on the social management system (PA1). These variables have been found to have very significant effects on the dependent variable, which we call outcome / grade of report. Except for the questions/variables that determine the audit result according to the model, no effect of items indicating company performance was found in the audit reports.

## DISCUSSION AND CONCLUSION

CSR and sustainability goals have developed and become a management system in the last 20 years. The companies of all sizes have been go through a process where need to compliance. It is seen that in order for companies to take part in sustainable supply chains created in global markets, to survive and to maximize their assets, they need to participate in the CSR management system and implement CSR activities by integrating them into all management processes and operations. The CSR management system has been seen as the first step for companies that want to develop international trade, while the Global Development Goals require every country to take responsibility as a result of the disasters, crises and environmental risks experienced in the 2000s. Implementing CSR management systems based on the principles of transparency and consistency has difficult due to the conservatism of companies and manufacturers in developing countries towards information sharing. For this reason, CSR management system standards and audits established by NGOs in European countries have become the first requirement for manufacturers to be included in the sustainable supply chain. Brands monitor their suppliers in the sustainable supply chain through CSR system audits and ethical trading platforms that include the results and improvements of these audits. In this way, brands that control the supply chain make strategic decisions and production plans based on the data provided by manufacturers through ethical trade platforms.

Standards for CSR management systems are being set by NGOs, and audit and evaluation processes are being pursued through web-based platforms, along with technological developments. The CSR management system seen as a costly system, as it has necessary to be included in more than one CSR management system audit, due to the fact that the audit and system establishment costs are borne by the manufacturer and they export to different regions. In order to make the decision to participate in the CSR management system, the companies has need to compare and analyze costs and benefits. For this reason, performance measurement of the CSR management system becomes mandatory. It can be seen

that the scope of most of the studies on the creation of models for measuring the performance of the CSR management system and its positive effects on business performance are generally large multinational companies, which has led some developing countries to carry out studies to create their own CSR index (Stanislavska et al., 2010; Berzau 2011; McWilliams and Siegel, 2011; Lioui and Sharma, 2012; Hamidu et al.,2015; Camilleri, 2017; Martinez-Conesa et al.,2017; Khalid et al., 2020).

A review of the literature found no recent studies that have evaluated the audit results of the most preferred CSR standards and relationship with business performance for small and medium-sized companies. In this context, this study has a unique value in terms of investigating its relationship with business performance using a ML model with respect to small and medium-sized companies in Turkey that are included in the Amfori BSCI audit and reporting, which is evaluated as relatively difficult from the global CSR standards. The study's objective is to identify the most significant factors in the environmental, social and economic dimensions that influence the audit outcome, as well as the relationship between business performance obtained from company data in the audit report and in relation to the audit outcome. The dataset, comprising 163 companies whose audit reports could be accessed in Turkey between 2018 and 2020, has used to achieve this. ML models created with Python programming language has preferred for analysis.

The ML model created with the Python programming language identified the most effective factors on the audit results of companies. It was observed that there were performance areas related to health and safety, reasonable working hours, fair remuneration and the general social management system. Furthermore, it was found that the items showing the business performance of the companies had no effect on the audit result. This suggests that the social dimension is weak in terms of CSR dimensions in our country. It can be posited that by focusing on the fundamental issues that represent the social dimension, CSR performance in sustainable supply chains will increase and contribute to sustainability goals. Future work could create a suitable interface for this analysis, allowing companies to self-assess whether they would bear the cost of such a system or to track their progress once they are in the system.

The limitations of this study include the inability to retrieve repeated reports through the ethical trading platform, and the inability to observe long-term change in performance. It would be beneficial for future research to analyse repeated outcomes over a longer period of time, which could assist business owners and stakeholders in understanding the present state of companies and their evolution over time. This study is distinguished from other similar studies in that it employs ML models based on audit reports in order to examine the audit outcomes and business performance of small and mid-sized companies. In particular, the results obtained by utilising the Python programming language and Pycaret library to create a ML model were compared with the outcomes of the application. Each additional report included in the ML model will contribute to an increase in its accuracy. This indicated a high level of accuracy, with a predicted rate of 89.56% for the future audit results of a company. The model's predictive accuracy is expected to increase with the incorporation of further reports.

It can be posited that the most crucial areas for improvement in Turkey with regard to CSR in the context of the 2030 Global Development Goals are occupational health and safety, compliance with reasonable working hours, and the sub-supplier audit process. In order for small and medium-sized companies in Turkey to produce high-value products, to play an important role in the implementation of strategies that follow technological developments, and to be competitive on a global scale, it is necessary to overcome their resistance to the implementation of CSR management. To enhance the efficacy of CSR initiatives, it is crucial to integrate them into the corporate culture, while simultaneously increasing government support for companies operating in various sectors and across different regions. In future studies designed to increase supply chain performance and assess CSR audit results and business performance, researchers should extend the time period to obtain more repeated reports and



produce continuously improving studies using ML models.

## References

- Ali, M., 2020. PyCaret: An open source, low-code machine learning library in Python. PyCaret version, 2. [Online]. Available: <https://www.pycaret.org>; Date of access: 14.02.2023.
- Amfori.,2022. Information about amfori's Producers. <https://www.amfori.org/sites/default/files/amfori-2020-09-01-producer-information>, <https://global-standard.org/the-standard/story>; Date of access: 12.07.2022.
- Amfori., 2023. Amfori Annual Report 2021. <https://www.amfori.org/sites/default/files/amfori-Annual-Report-2021.pdf>; Date of access: 3.07.2023.
- Asiaei, K., Bontis, N., Barani, O. and Jusoh, R., 2021. Corporate Social Responsibility and Sustainability Performance Measurement Systems: Implications for Organizational Performance. *Journal of Management Control*, 32(1): 85-126.
- Avram, E. and Avasilcai, S., 2014. Business Performance Measurement in Relation to corporate social responsibility: A conceptual model development. *Procedia-Social and Behavioral Sciences*, 109, 1142-1146.
- Baker, S. R., Bloom, N., Davis, S. J., 2016. Measuring economic policy uncertainty. *The quarterly journal of economics*, 131(4), 1593-1636.
- Balatbat, M., Siew, R., Carmichael, D., 2012. ESG scores and its influence on firm performance: Australian evidence. In *Australian school of business school of accounting, school of accounting seminar series semester, (2):1-30*. Sydney, Australia: University of New South Wales.
- Berzau, L., 2011. The Business Social Compliance Initiative: A system for the Continuous Improvement of Social Compliance in Global Supply Chains. *Zeitschrift fuer Wirtschafts-und Unternehmensethik*, 12(1): 139.
- Camilleri, M. A., 2017. Corporate Sustainability And Responsibility Creating Value For Business, Society And The Environment. *Asian Journal of Sustainability and Social Responsibility*, 2(1): 59-74.
- Carroll, A. B.,1999. Corporate Social Responsibility: Evolution Of A Definitional Construct. *Business & Society*, 38(3): 268-295.
- Carroll, A. B., Brown, J. A., 2018. Corporate social responsibility: A review of current concepts, research, and issues. *Corporate social responsibility*, 39-69.
- Chang TY, Chen GY, Chen JJ, Young LH, Chang LT., 2023. Application of artificial intelligence algorithms and low-cost sensors to estimate respirable dust in the workplace. *Environ Int*. 2023;182:108317.
- Clarkson, M. E.,1995. A stakeholder framework for analyzing and evaluating corporate social performance. *Academy of management review*, 20(1): 92-117.
- Davis, I.,2005. What is the Business of Business. *McKinsey Quarterly*, 3(1): 104-113.
- Fatima, T., Elbanna, S.,2022. Corporate Social Responsibility (CSR) Implementation: a Review and a Research Agenda Towards an Integrative Framework. *Journal of Business Ethics*, 1-17.
- Figge, F., Hahn, T., Schaltegger, S., Wagner, M.,2002. The Sustainability Balanced Scorecard–Linking Sustainability Management to Business Strategy. *Business strategy and the Environment*, 11(5): 269-284.
- Govindan, K., 2022. Theory Building Through Corporate Social Responsibility 4.0 for Achieving SDGs: A Practical Step Toward Integration of Digitalization With Practice-Based View and Social Good Theory. *IEEE Transactions on Engineering Management*, (71): 2103-2120.
- Gültepe, Y., 2019. Makine öğrenmesi algoritmaları ile hava kirliliği tahmini üzerine karşılaştırmalı bir değerlendirme. *Avrupa Bilim ve Teknoloji Dergisi*, (16): 8-15.
- Hack, L., Kenyon, A. J., Wood, E. H.,2014. A critical corporate social responsibility (CSR) timeline: How should it be understood now. *International Journal of Management Cases*, 16(4): 46-55.
- Hamidu, A., Haron, M., Amran, A.,2015. Corporate social responsibility: A review on definitions, core characteristics and theoretical perspectives. *Mediterranean Journal of Social Sciences*, 6(4), 83-95.
- He, F., Qin, S., Liu, Y., Wu, J. G., 2022. CSR and Idiosyncratic Risk: Evidence from ESG Information Disclosure. *Finance Research Letters*, 102936.
- Höllerer, M. A., 2012. *Between Creed, Rhetoric Façade, and Disregard: Dissemination and Theorization of Corporate Social Responsibility in Austria (p. 257)*. Peter Lang International Academic Publishers.

- ISO.,2022. Certification, Verification, Assessment. Internet: <https://iso26000.info>; Date of access: 22.06.2022.
- Iqbal, F. B., Biswas, S., Urba, R., 2021. Performance analysis of intrusion detection systems using the PyCaret machine learning library on the UNSW-NB15 dataset (Doctoral dissertation, Brac University).
- Kaplan, R. S., Norton, D. P.,2005. The Balanced Scorecard: Measures that drive Performance. *Harvard Business Review*, 83(7): 172.
- Karasu, S., Altan, A., Saraç, Z., Hacıoğlu, R.,2018. Prediction of Bitcoin Prices with Machine Learning methods Using Time Series Data. In 2018 26th signal processing and communications applications conference (SIU), 1-4. IEEE.
- Khalid, M. K., Agha, M. H., Shah, S. T. H., Akhtar, M. N., 2020. Conceptualizing audit fatigue in the context of sustainable supply chains. *Sustainability*, 12(21): 9135.
- Laermann, M. (2016). The Significance of ESG Ratings for Socially Responsible Investment Decisions: An examination from a market perspective. Available at SSRN 2873126.
- Lioui, A., Sharma, Z., 2012. Environmental corporate social responsibility and financial performance: Disentangling direct and indirect effects. *Ecological Economics*, 78, 100-111.
- Martinez-Conesa, I., Soto-Acosta, P., Palacios-Manzano, M.,2017. Corporate social responsibility and its effect on innovation and firm performance: An empirical research in SMEs. *Journal of cleaner production*, 142, 2374-2383.
- McWilliams, A., Siegel, D.,2001. Corporate social responsibility: A theory of the firm perspective. *Academy Of Management Review*, 26(1): 117-127.
- McWilliams, A., Siegel, D. S.,2011. Creating and capturing value: Strategic corporate social responsibility, resource-based theory, and sustainable competitive advantage. *Journal of management*, 37(5): 1480-1495.
- Rodriguez-Gomez, S., Arco-Castro, M. L., Lopez-Perez, M. V., Rodríguez-Ariza, L. 2020. Where does CSR come from and where does it go? A review of the state of the art. *Administrative Sciences*, 10(3), 60.
- Stanislavska, L., Margarisova, K., Stastna, K.,2010. International standards of corporate social responsibility. *AGRIS on-line Papers in Economics and Informatics*, 2(665-2016-44847), 63-72.
- Theapsca., 2022. Apsca Newsletters. <https://www.theapsca.org/apsca-newsletters/2015/08/>; ; Date of access: 13.07.2022.
- Tilakasiri, K. K., 2012. Corporate social responsibility and company performance: evidence from Sri Lanka (Doctoral dissertation, Victoria University).
- Van Marrewijk, M.,2003. Concepts and definitions of CSR and corporate sustainability: Between agency and communion. *Journal of business ethics*, 44(2): 95-105.
- Wekesa, M. K., Kimutai, G.,2018. Corporate social responsibility and firm performance; effect of sustainability management systems in selected Kenyan sugar companies. *International Journal of Research in Education and Social Sciences (IJRESS)*, 1(2), 67-82.
- Yalçınkaya, AE.,2023. Tedarik zinciri yönetiminde etik ticaret platformlarının ve global optimizasyon sürecinin sürdürülebilirlik açısından etkileri (Doctoral dissertation, Dokuz Eylül University), İzmir.
- Yu, S. H., Liang, W. C.,2020. Exploring the determinants of strategic corporate social responsibility: An empirical examination. *Sustainability*, 12(6): 2368.

### **Acknowledgment**

We would like to thank all the participants in the study.

### **Conflict of Interest**

The authors declared that they have no conflict of interest.

### **Author Contributions**

All authors contributed equally to the literature and analysis of the study.